

## Automotive turbo 2 ultrafast high voltage rectifier

Datasheet - production data

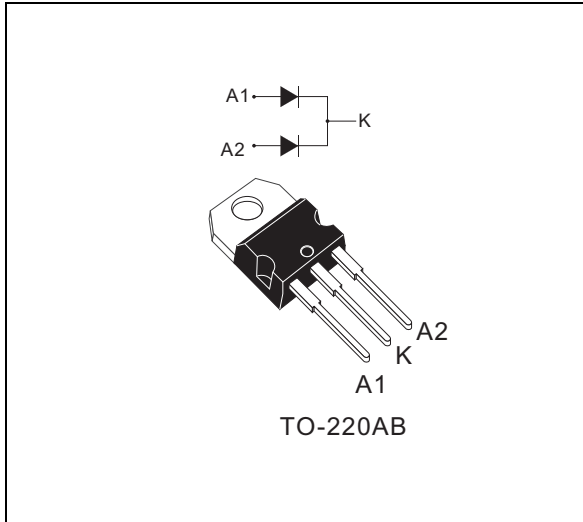

### Description

The STTH16L06C-Y is developed using ST's Turbo 2 600 V technology. It's specially suited for use in switching power supplies as rectifier and discontinuous mode PFC boost diode for automotive applications.

Table 1. Device summary

Symbol	Value
$I_{F(AV)}$	Up to 2 x 10 A
$V_{RRM}$	600 V
$T_j$	175 °C
$V_F$ (typ)	1.05 V
$t_{rr}$ (max)	35 ns

### Features

- AEC-Q101 qualified
- Ultrafast switching
- Low reverse recovery current
- Reduces switching and conduction losses
- Low thermal resistance
- PPAP capable
- ECOPACK<sup>®</sup>2 compliant component

# 1 Characteristics

**Table 2. Absolute ratings (limiting values)**

Symbol	Parameter		Value	Unit	
$V_{RRM}$	Repetitive peak reverse voltage, $T_j = -40\text{ °C}$		600	V	
$I_{F(RMS)}$	Forward rms current		30	A	
$I_{F(AV)}$	Average forward current $\delta = 0.5$	TO-220AB	$T_c = 140\text{ °C}$ Per diode	8	A
			$T_c = 135\text{ °C}$ Per device	16	
			$T_c = 130\text{ °C}$ Per diode	10	
			$T_c = 120\text{ °C}$ Per device	20	
$I_{FSM}$	Surge non repetitive forward current	$t_p = 10\text{ ms}$ sinusoidal	120	A	
$T_{stg}$	Storage temperature range		-65 to + 175	°C	
$T_j$	Operating junction temperature		-40 to +175	°C	

**Table 3. Thermal parameter**

Symbol	Parameter		Maximum	Unit	
$R_{th(j-c)}$	Junction to case	TO-220AB	Per diode	2.5	°C/W
		TO-220AB	Total	1.6	
$R_{th(c)}$	Coupling	TO-220AB		0.7	

When the diodes 1 and 2 are used simultaneously:

$$\Delta T_j (\text{diode1}) = P_{(\text{diode1})} \times R_{th(j-c)} (\text{per diode}) + P_{(\text{diode2})} \times R_{th(c)}$$

**Table 4. Static electrical characteristics**

Symbol	Parameter	Test conditions		Min.	Typ	Max.	Unit
$I_R^{(1)}$	Reverse leakage current	$T_j = 25\text{ °C}$	$V_R = V_{RRM}$			8	$\mu\text{A}$
		$T_j = 150\text{ °C}$			25	240	
$V_F^{(2)}$	Forward voltage drop	$T_j = 25\text{ °C}$	$I_F = 8\text{ A}$			1.8	V
		$T_j = 150\text{ °C}$			1.05	1.35	
		$T_j = 25\text{ °C}$	$I_F = 16\text{ A}$			2.08	
		$T_j = 150\text{ °C}$			1.28	1.64	

1. Pulse test:  $t_p = 5\text{ ms}$ ,  $\delta < 2\%$

2. Pulse test:  $t_p = 380\text{ }\mu\text{s}$ ,  $\delta < 2\%$

To evaluate the maximum conduction losses use the following equation:

$$P = 1.06 \times I_{F(AV)} + 0.036 I_{F(RMS)}^2$$

Table 5. Dynamic electrical characteristics

Symbol	Parameter	Test conditions		Min.	Typ	Max.	Unit
$t_{rr}$	Reverse recovery time	$T_j = 25\text{ °C}$	$I_F = 0.5\text{ A}$ , $I_{rr} = 0.25\text{ A}$ , $I_R = 1\text{ A}$			35	ns
			$I_F = 1\text{ A}$ , $di_F/dt = 50\text{ A}/\mu\text{s}$ , $V_R = 30\text{ V}$		40	55	
$I_{RM}$	Reverse recovery current	$T_j = 125\text{ °C}$	$I_F = 8\text{ A}$ , $di_F/dt = 100\text{ A}/\mu\text{s}$ , $V_R = 400\text{ V}$		4.5	6.5	A
$t_{fr}$	Forward recovery time	$T_j = 25\text{ °C}$	$I_F = 8\text{ A}$ $di_F/dt = 100\text{ A}/\mu\text{s}$ $V_{FR} = 1.1 \times V_{Fmax}$			200	ns
$V_{FP}$	Forward recovery voltage				3.5		V

Figure 1. Conduction losses versus average current

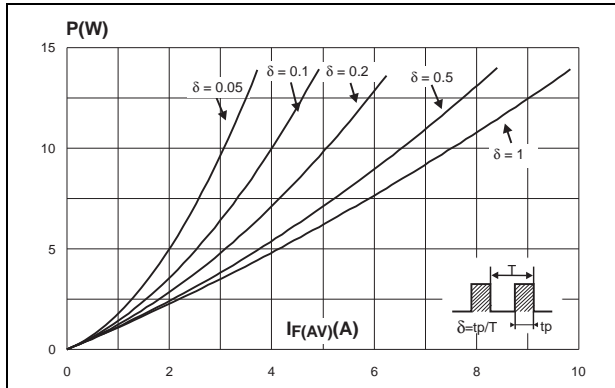

Figure 2. Forward voltage drop versus forward current

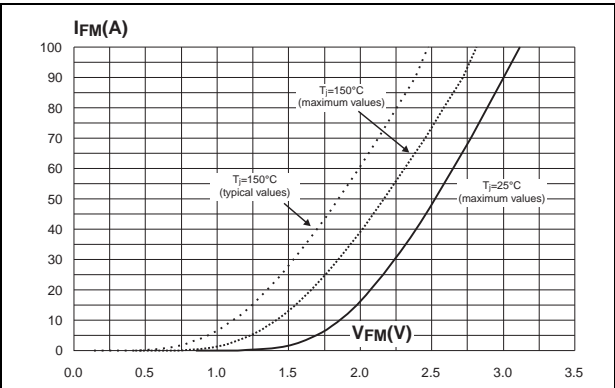

Figure 3. Peak reverse recovery current versus  $di_F/dt$  (typical values, per diode)

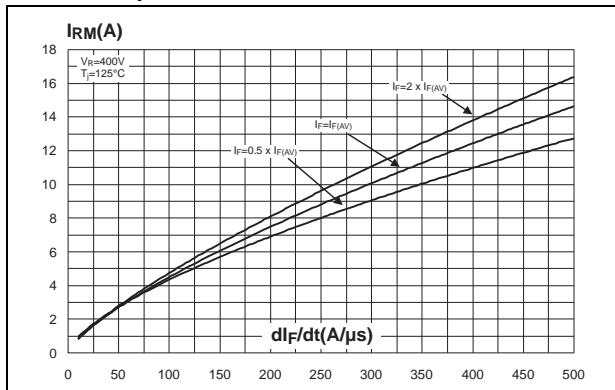

Figure 4. Reverse recovery time versus  $di_F/dt$  (typical values, per diode)

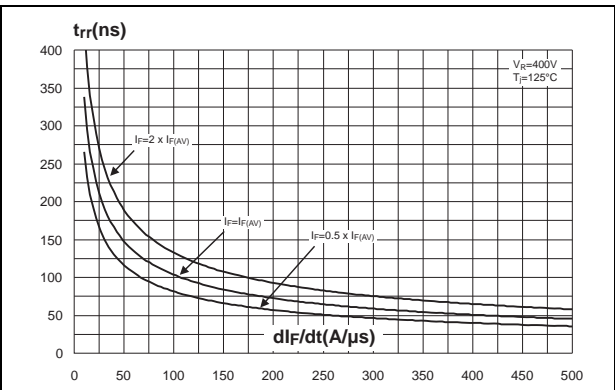

Figure 5. Reverse recovery charges versus  $di_F/dt$  (typical values, per diode)

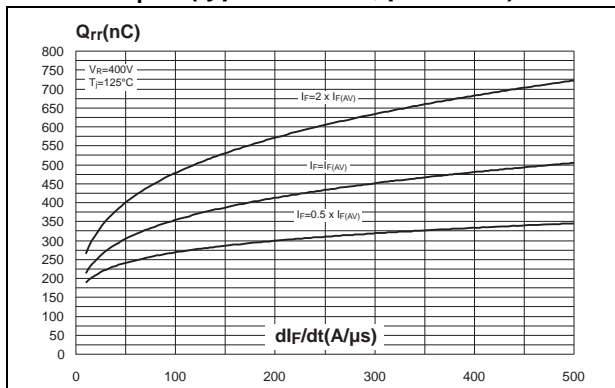

Figure 6. Softness factor versus  $di_F/dt$  (typical values, per diode)

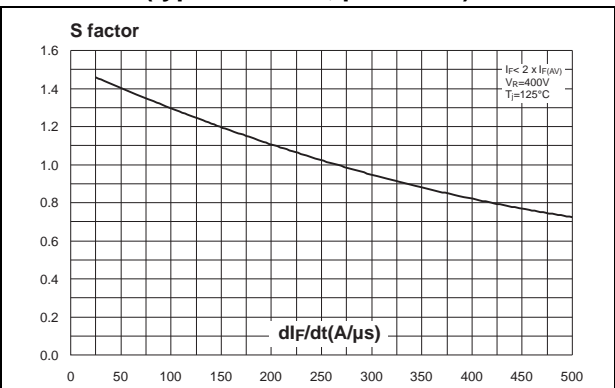

Figure 7. Relative variations of dynamic parameters versus junction temperature

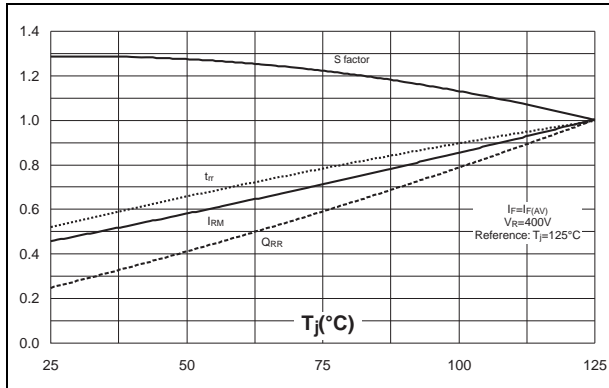

Figure 8. Transient peak forward voltage versus  $dI_F/dt$  (typical values, per diode)

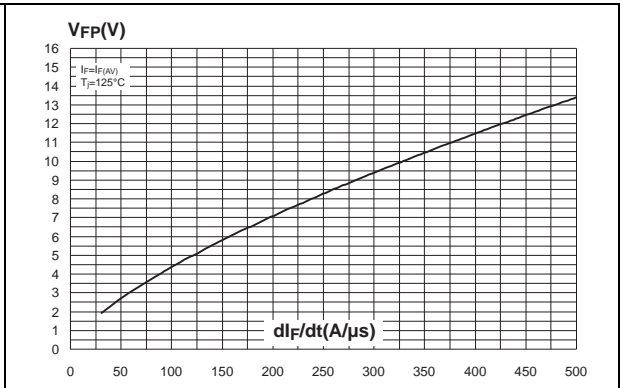

Figure 9. Forward recovery time versus  $dI_F/dt$  (typical values, per diode)

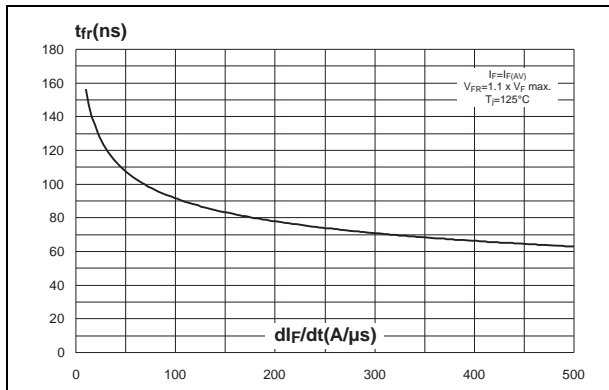
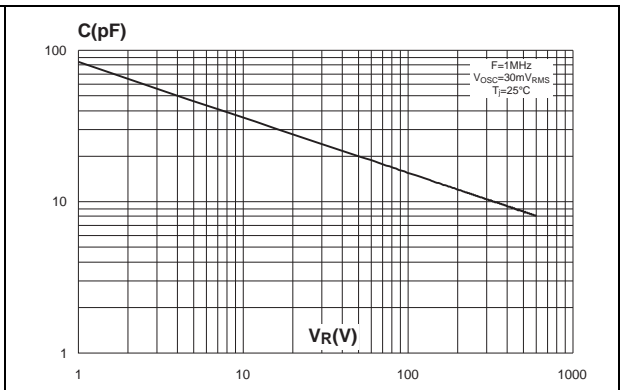

Figure 10. Junction capacitance versus reverse voltage applied (typical values, per diode)



## 2 Package information

- Epoxy meets UL94, V0
- Cooling method: by conduction (C)
- Recommended torque value for TO-220AB and TO-220FPAB: 0.4 N·m to 0.6 N·m

In order to meet environmental requirements, ST offers these devices in different grades of ECOPACK® packages, depending on their level of environmental compliance. ECOPACK® specifications, grade definitions and product status are available at: [www.st.com](http://www.st.com). ECOPACK® is an ST trademark.

Figure 11. TO-220AB dimension definitions

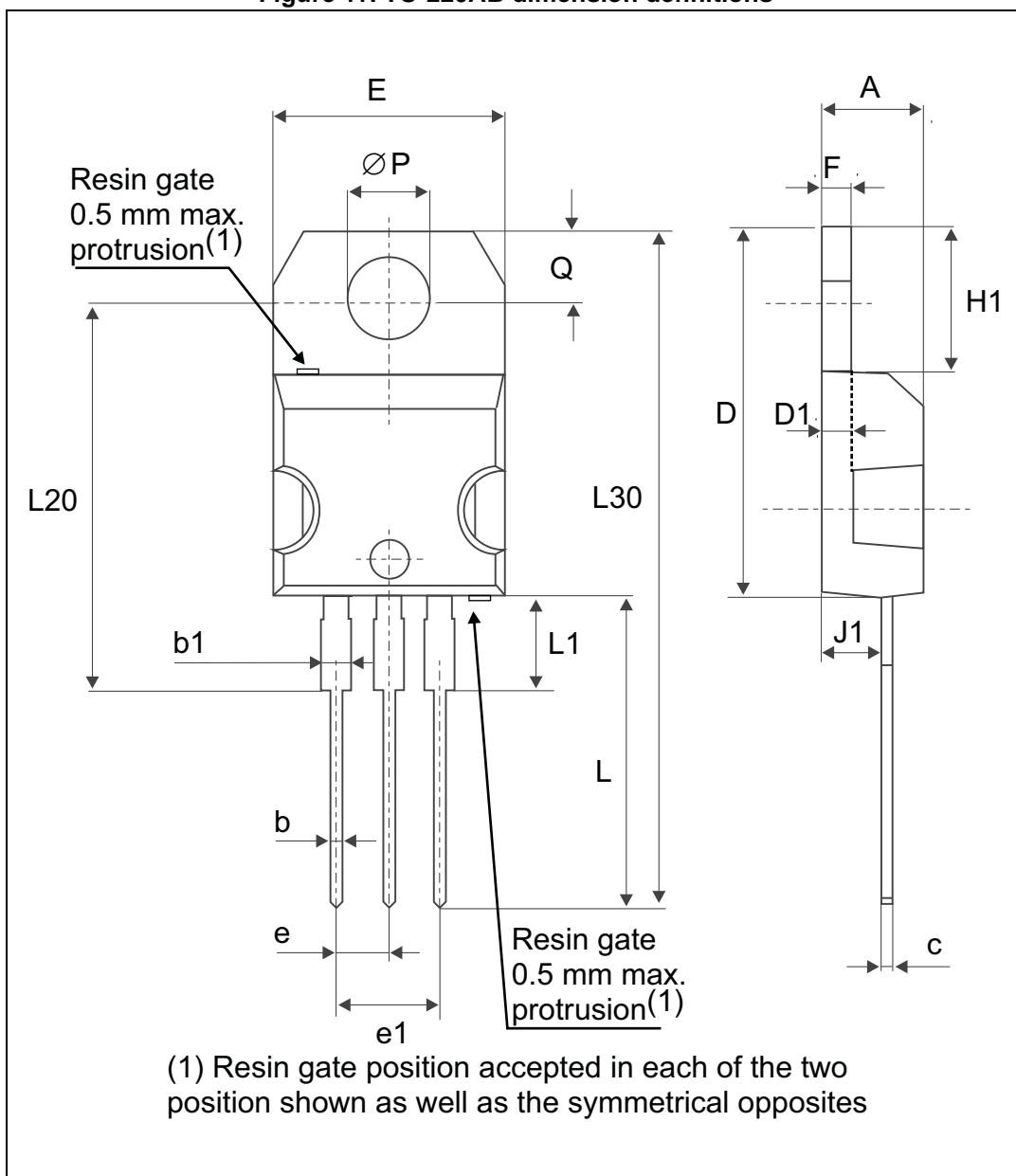

Table 6. TO-220AB dimension values

Ref.	Dimensions			
	Millimeters		Inches	
	Min.	Max.	Min.	Max.
A	4.40	4.60	0.17	0.18
b	0.61	0.88	0.024	0.035
b1	1.14	1.70	0.045	0.067
c	0.48	0.70	0.019	0.027
D	15.25	15.75	0.60	0.62
D1	1.27 typ.		0.05 typ.	
E	10	10.40	0.39	0.41
e	2.40	2.70	0.094	0.106
e1	4.95	5.15	0.19	0.20
F	1.23	1.32	0.048	0.052
H1	6.20	6.60	0.24	0.26
J1	2.40	2.72	0.094	0.107
L	13	14	0.51	0.55
L1	3.50	3.93	0.137	0.154
L20	16.40 typ.		0.64 typ.	
L30	28.90 typ.		1.13 typ.	
ØP	3.75	3.85	0.147	0.151
Q	2.65	2.95	0.104	0.116

### 3 Ordering information

**Table 7. Ordering information**

Order code	Marking	Package	Weight	Base qty	Delivery mode
STTH16L06CTY	STTH16L06CTY	TO-220AB	2.23 g	50	Tube

### 4 Revision history

**Table 8. Document revision history**

Date	Revision	Changes
19-Nov-2014	1	First issue.
12-Dec-2014	2	Removed TO-220FPAB and D <sup>2</sup> PAK package information.



**IMPORTANT NOTICE – PLEASE READ CAREFULLY**

STMicroelectronics NV and its subsidiaries ("ST") reserve the right to make changes, corrections, enhancements, modifications, and improvements to ST products and/or to this document at any time without notice. Purchasers should obtain the latest relevant information on ST products before placing orders. ST products are sold pursuant to ST's terms and conditions of sale in place at the time of order acknowledgement.

Purchasers are solely responsible for the choice, selection, and use of ST products and ST assumes no liability for application assistance or the design of Purchasers' products.

No license, express or implied, to any intellectual property right is granted by ST herein.

Resale of ST products with provisions different from the information set forth herein shall void any warranty granted by ST for such product.

ST and the ST logo are trademarks of ST. All other product or service names are the property of their respective owners.

Information in this document supersedes and replaces information previously supplied in any prior versions of this document.

© 2014 STMicroelectronics – All rights reserved

