

ESD5325E
**4-Lines, Uni-directional, Low Capacitance
Transient Voltage Suppressors**
Descriptions

The ESD5325E is a low capacitance TVS (Transient Voltage Suppressor) array designed to protect high speed data interfaces. It has been specifically designed to protect sensitive electronic components which are connected to data and transmission lines from over-stress caused by ESD (Electrostatic Discharge).

The ESD5325E incorporates four pairs of low capacitance steering diodes plus a TVS diode.

The ESD5325E may be used to provide ESD protection up to $\pm 30\text{kV}$ (contact discharge) according to IEC61000-4-2, and withstand peak pulse current up to 6A (8/20 μs) according to IEC61000-4-5.

The ESD5325E is available in SOT23-6L package. Standard products are Pb-free and Halogen-free.

Features

- Reverse stand-off voltage: 6V max. (VDD to GND)
- Transient protection for each line according to IEC61000-4-2 (ESD): $\pm 30\text{kV}$ (contact discharge)
IEC61000-4-5 (surge): 6A (8/20 μs)
- Low capacitance: $C_{\text{I/O-GND}} = 1.0\text{pF}$ typ.
- Ultra-low leakage current: $I_{\text{R}} < 1\text{nA}$ typ.
- Low clamping voltage: $V_{\text{CL I/O-GND}} = 12.5\text{V}$ @ $I_{\text{PP}} = 16\text{A}$ (TLP)
- Solid-state silicon technology

Applications

- USB 2.0
- Video Graphics Cards
- DVI
- IEEE 1394
- Monitors and Flat Panel Displays
- 10/100 Ethernet
- Notebooks

<http://www.sh-willsemi.com>

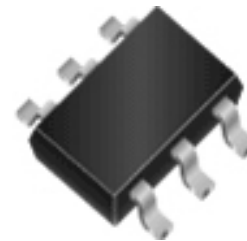

SOT23-6L

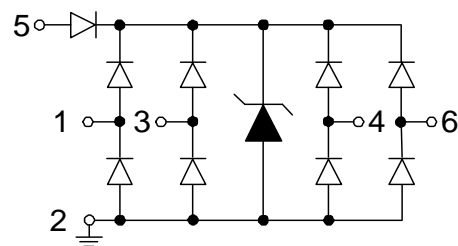

Circuit diagram

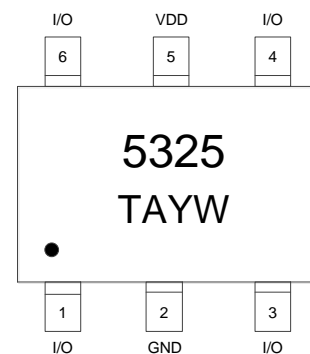

5325 = Device code
TA = Special code
YW = Date code

Marking & Pin configuration (Top View)
Order information

Device	Package	Shipping
ESD5325E-6/TR	SOT23-6L	3000/Tape&Reel

Absolute maximum ratings

Parameter	Symbol	Rating	Unit
Peak pulse power ($t_p = 8/20\mu s$)	P_{pk}	70	W
Peak pulse current ($t_p = 8/20\mu s$)	I_{PP}	6	A
Operating Supply Voltage (VDD to GND)	V_{DC}	6	V
ESD according to IEC61000-4-2 air discharge(I/O pins)	V_{ESD}	± 30	kV
ESD according to IEC61000-4-2 contact discharge(I/O pins)		± 30	
Junction temperature	T_J	125	$^{\circ}C$
Operation temperature	T_{OP}	-40 to 85	$^{\circ}C$
Storage temperature	T_{STG}	-55 to 150	$^{\circ}C$
Lead temperature	T_L	260	$^{\circ}C$

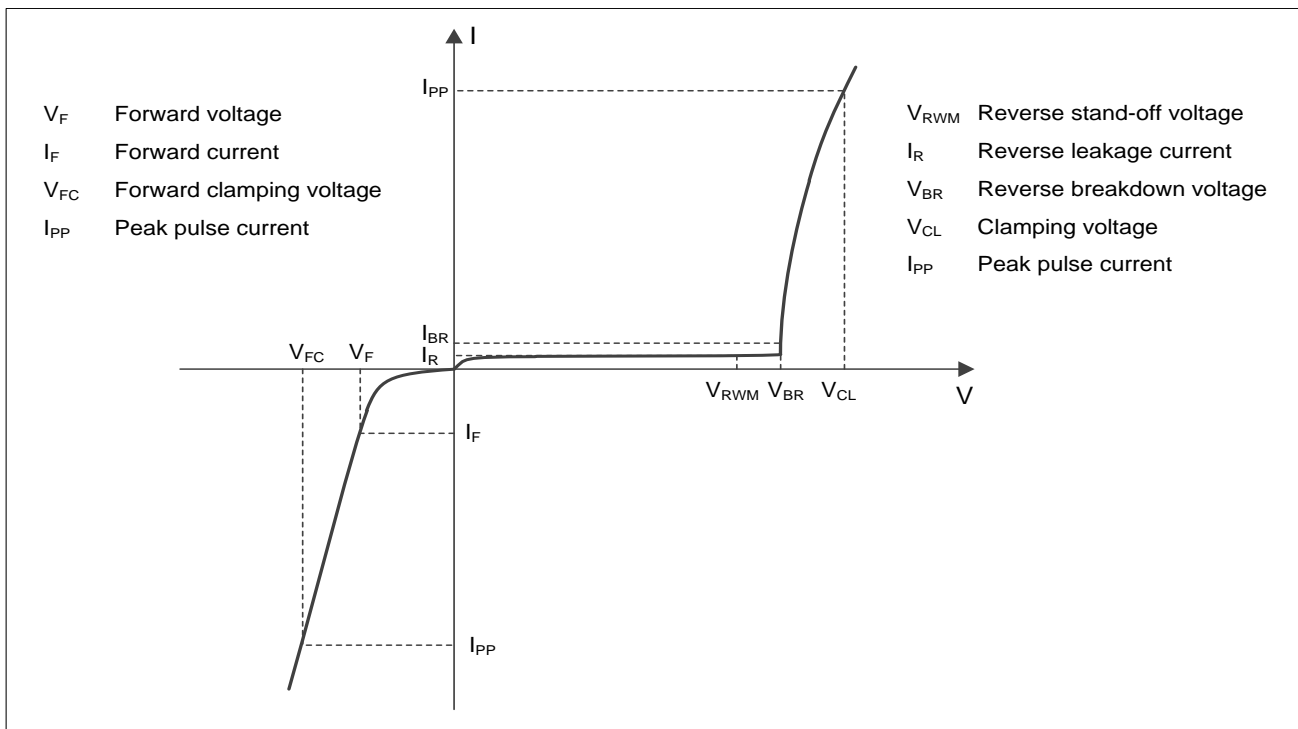
Electrical characteristics ($T_A = 25^{\circ}C$, unless otherwise noted)

Definitions of electrical characteristics

Electrical characteristics ($T_A = 25^\circ\text{C}$, unless otherwise noted)

Parameter	Symbol	Condition	Min.	Typ.	Max.	Unit
I/O Pins						
Reverse stand-off voltage	V_{RWM}				5.0	V
Reverse leakage current	I_R	$V_{RWM} = 5V$		<1	100	nA
Reverse breakdown voltage	V_{BR}	$I_{BR} = 1\text{mA}$	7.0	8.0	9.0	V
Forward voltage	V_F	$I_F = 10\text{mA}$	0.6	0.9	1.2	V
Clamping voltage ¹⁾	V_{CL}	$I_{PP} = 16\text{A}$, $t_p = 100\text{ns}$		12.5		V
Dynamic resistance ¹⁾	R_{DYN}	$t_p = 100\text{ns}$		0.24		Ω
Clamping voltage ²⁾	V_{CL}	$V_{ESD} = 8\text{kV}$		12.5		V
Clamping voltage ³⁾	V_{CL}	$I_{PP} = 1\text{A}$, $t_p = 8/20\mu\text{s}$		8.5		V
		$I_{PP} = 6\text{A}$, $t_p = 8/20\mu\text{s}$		11.5		V
Junction capacitance	$C_{I/O-GND}$	$V_R = 0V$, $f = 1\text{MHz}$, Any I/O to GND		1.0	1.6	pF
	$C_{I/O-I/O}$	$V_R = 0V$, $f = 1\text{MHz}$, Any I/O to I/O		0.50	0.80	pF
VDD Pin						
Reverse stand-off voltage	V_{RWM}				6	V
Reverse leakage current	I_R	$V_{RWM} = 6V$			1	μA
Reverse breakdown voltage	V_{BR}	$I_{BR} = 1\text{mA}$	7.0	8.0	9.0	V
Forward voltage	V_F	$I_F = 10\text{mA}$	0.6	0.9	1.2	V
Clamping voltage ¹⁾	V_{CL}	$I_{PP} = 16\text{A}$, $t_p = 100\text{ns}$		12.0		V
Dynamic resistance ¹⁾	R_{DYN}	$t_p = 100\text{ns}$		0.21		Ω
Clamping voltage ²⁾	V_{CL}	$V_{ESD} = 8\text{kV}$		12.0		V
Clamping voltage ³⁾	V_{CL}	$I_{PP} = 1\text{A}$, $t_p = 8/20\mu\text{s}$		8.5		V
		$I_{PP} = 6\text{A}$, $t_p = 8/20\mu\text{s}$		11.0		V

Notes:

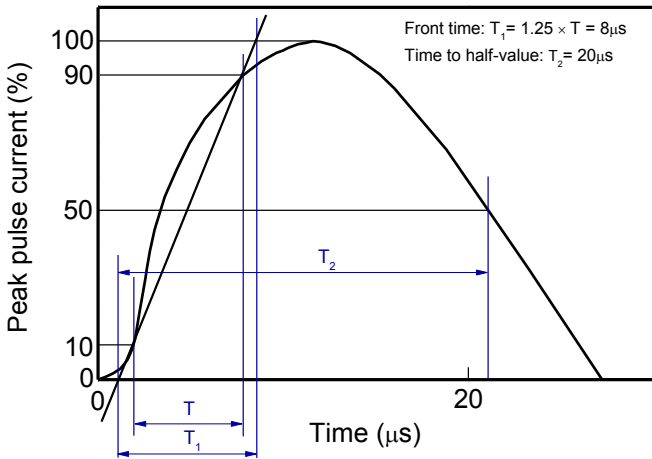
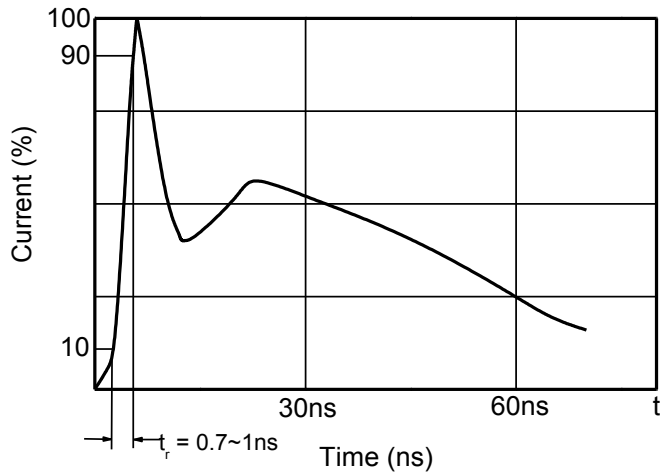
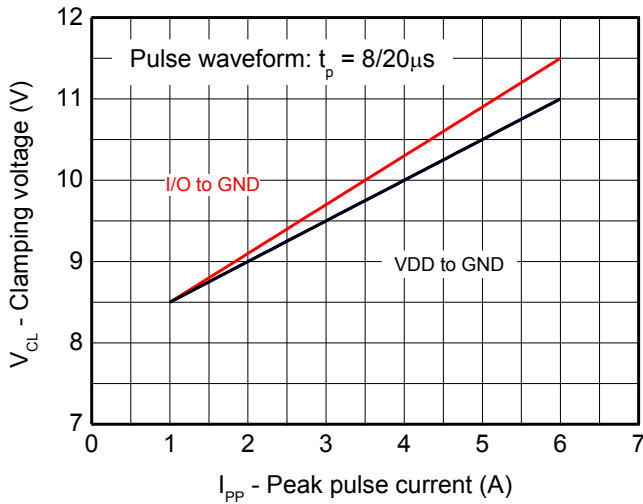
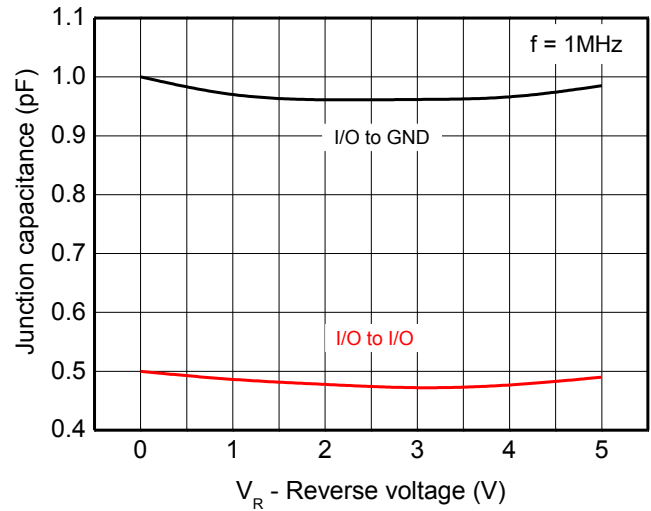
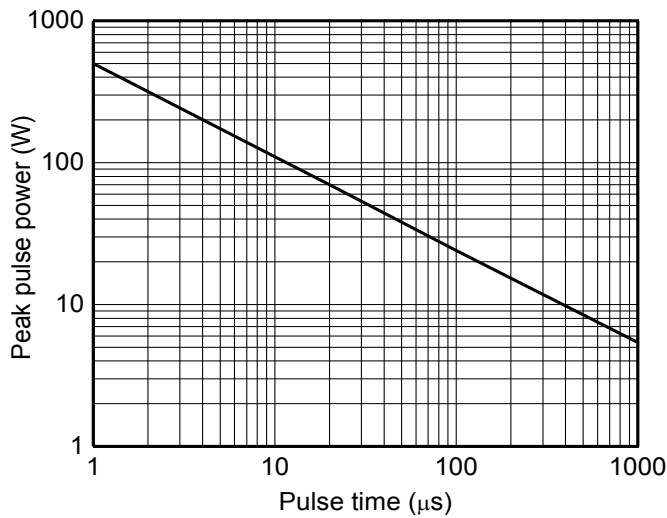
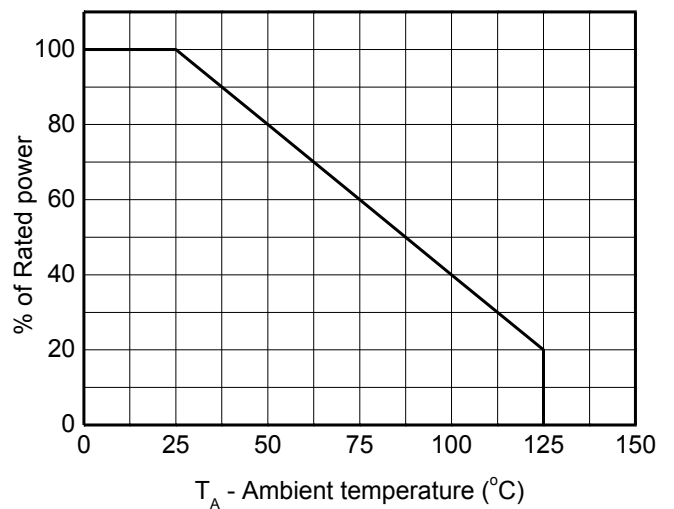
- 1) TLP parameter: $Z_0 = 50\Omega$, $t_p = 100\text{ns}$, $t_r = 2\text{ns}$, averaging window from 60ns to 80ns. R_{DYN} is calculated from 4A to 16A.
- 2) Contact discharge mode, according to IEC61000-4-2.
- 3) Non-repetitive current pulse, according to IEC61000-4-5.

Typical characteristics ($T_A = 25^\circ\text{C}$, unless otherwise noted)

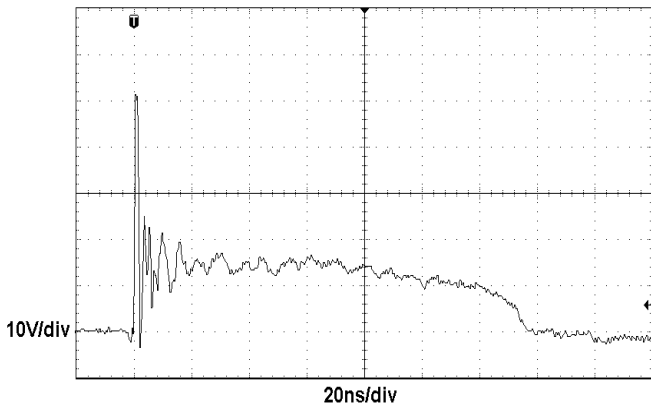
8/20μs waveform per IEC61000-4-5

Contact discharge current waveform per IEC61000-4-2

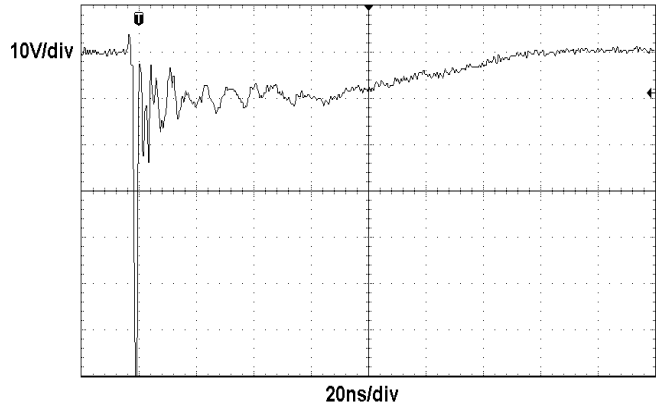
Clamping voltage vs. Peak pulse current

Capacitance vs. Reverse voltage

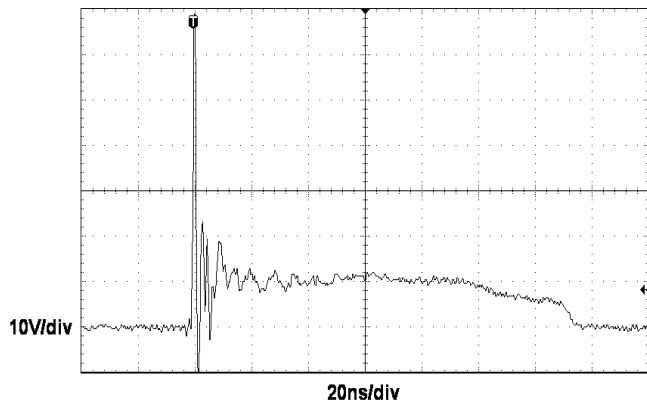
Non-repetitive peak pulse power vs. Pulse time

Power derating vs. Ambient temperature

Typical characteristics ($T_A = 25^\circ\text{C}$, unless otherwise noted)

ESD clamping - I/O to GND
 (+8kV contact discharge per IEC61000-4-2)



ESD clamping - I/O to GND
 (-8kV contact discharge per IEC61000-4-2)



ESD clamping - VDD to GND
 (+8kV contact discharge per IEC61000-4-2)

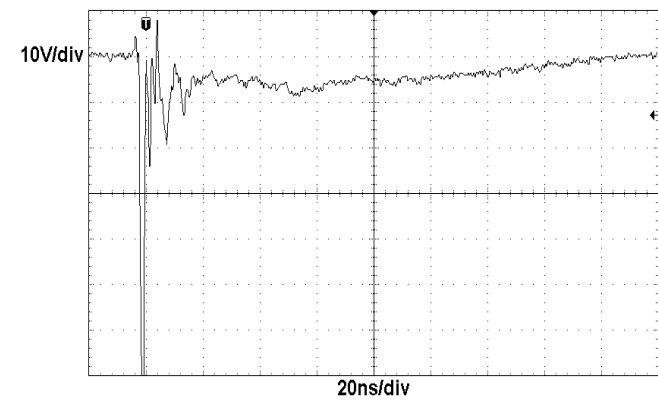

ESD clamping - VDD to GND
 (-8kV contact discharge per IEC61000-4-2)

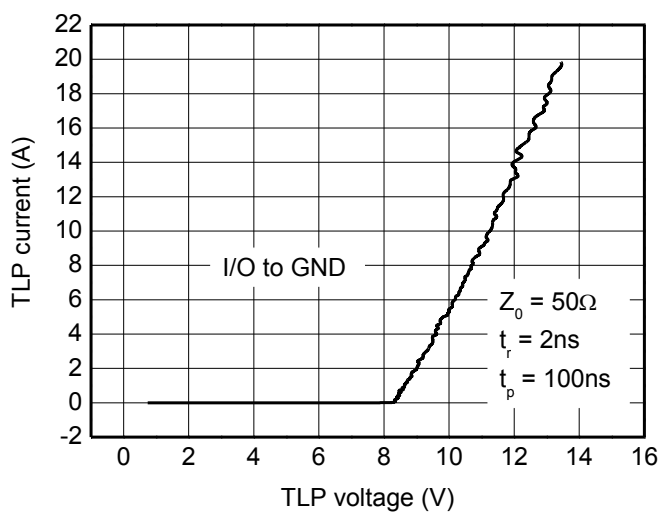

TLP Measurement - I/O to GND

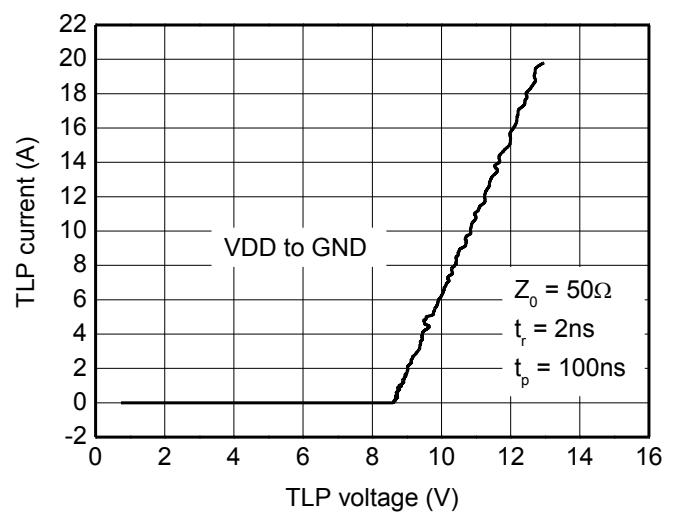

TLP Measurement - VDD to GND

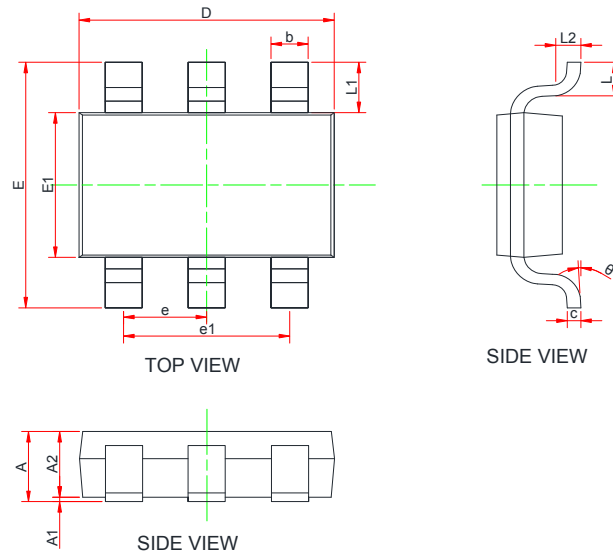
PACKAGE OUTLINE DIMENSIONS
SOT-23-6L

Symbol	Dimensions in Millimeters		
	Min.	Typ.	Max.
A	1.05	-	1.45
A1	0	-	0.15
A2	0.90	1.10	1.30
b	0.30	0.40	0.50
c	0.10	-	0.21
D	2.72	2.92	3.12
E	2.60	2.80	3.00
E1	1.40	1.60	1.80
e	0.85	0.95	1.05
e1	1.80	1.90	2.00
L	0.30	-	0.60
L1	0.59Ref		
L2	0.25Ref		
θ	0 °	-	8 °

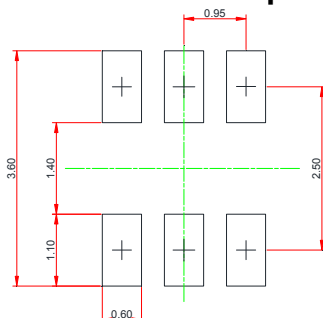
Recommended land pattern (Unit: mm)

Notes:

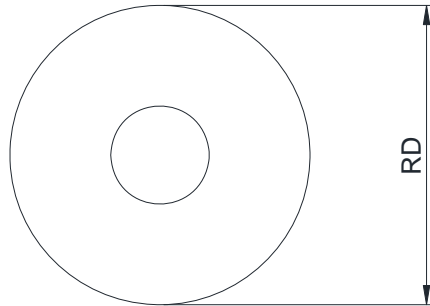
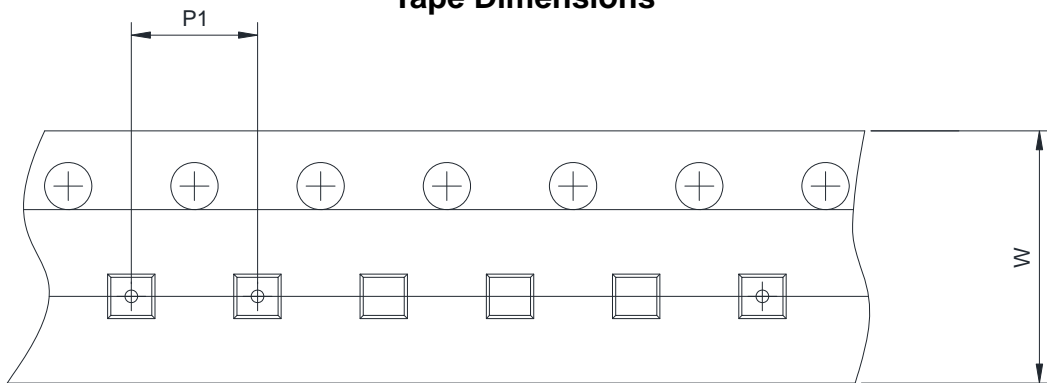
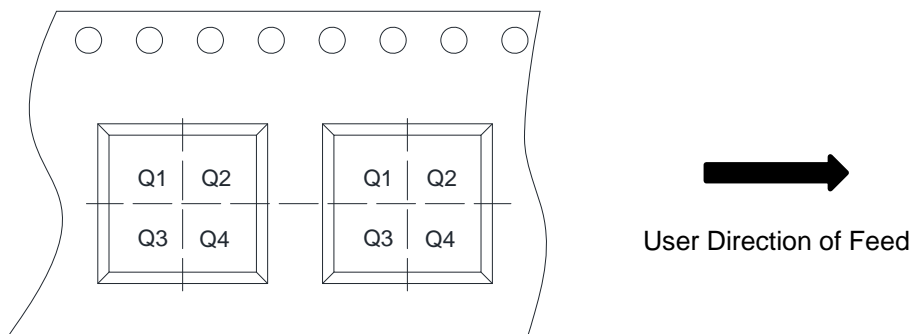
This recommended land pattern is for reference purposes only. Please consult your manufacturing group to ensure your PCB design guidelines are met.

TAPE AND REEL INFORMATION
Reel Dimensions

Tape Dimensions

Quadrant Assignments For PIN1 Orientation In Tape

RD	Reel Dimension	<input checked="" type="checkbox"/> 7inch	<input type="checkbox"/> 13inch	
W	Overall width of the carrier tape	<input checked="" type="checkbox"/> 8mm	<input type="checkbox"/> 12mm	<input type="checkbox"/> 16mm
P1	Pitch between successive cavity centers	<input type="checkbox"/> 2mm	<input checked="" type="checkbox"/> 4mm	<input type="checkbox"/> 8mm
Pin1	Pin1 Quadrant	<input type="checkbox"/> Q1	<input type="checkbox"/> Q2	<input checked="" type="checkbox"/> Q3 <input type="checkbox"/> Q4