

EAHP2016YA0-AM



Features

- Ceramic package.
- Top view LED
- Wide viewing angle 130°
- High luminous intensity output
- Qualification according to AEC-Q101 rev C.
- Automotive reflow profile (IR reflow or wave soldering)
- Pb-free
- RoHS compliant
- ESD protection
- Compliance with EU REACH.

Description

The Everlight EAHP2016-AM series package has high efficacy, high power consumption, wide viewing angle and a compact form factor. These features make this package an ideal LED for all automobile lighting applications.

Applications

- Turning indicator light
- Tail light

CONFIDENTIAL

Table of Contents

EAHP2016 Soldering Temperature Location on Sample Board	3
Absolute Maximum Ratings	4
PN of the EAHP2016-AM series	5
Product Binning	6
Mechanical Dimension	8
Wavelength Characteristics	9
Typical Radiation Patterns	12
Moisture Resistant Packing Materials.....	13
Storage Conditions	15
Revision History.....	17

CONFIDENTIAL

EAHP2016 Soldering Temperature Location on Sample Board

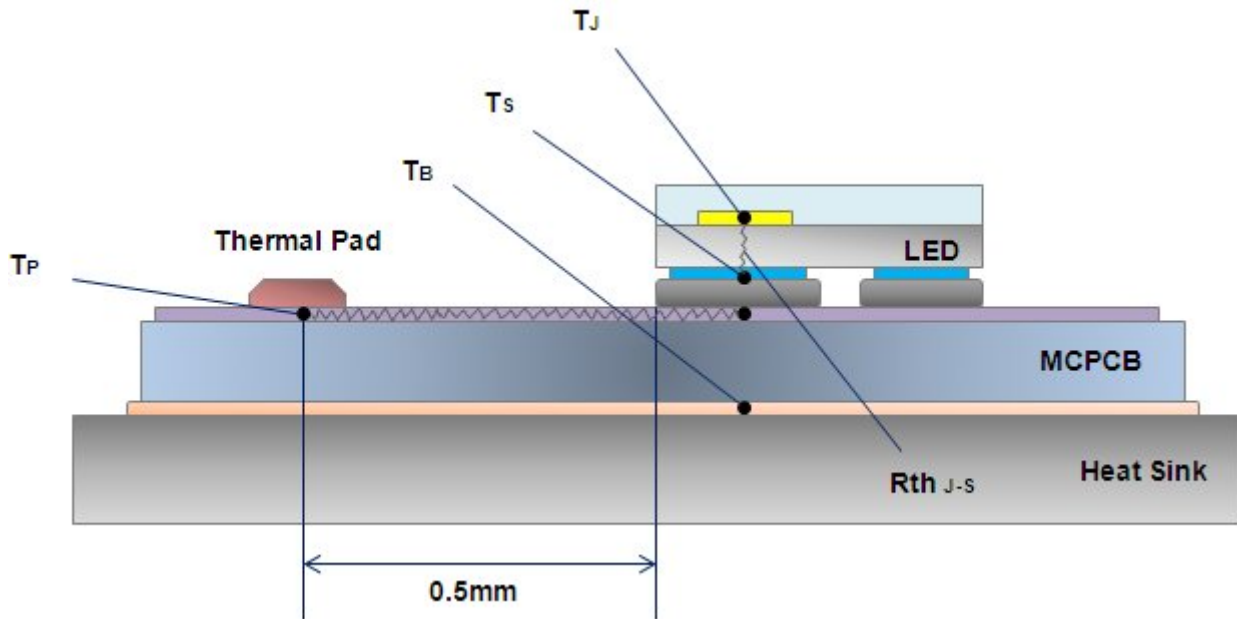

T_J = Temperature of Junction

T_S = Temperature of Solder Pad

T_B = Temperature of MCPCB

T_P = Temperature of Thermal Pad

$R_{th\ J-S}$ = Thermal Resistance from Junction to Solder Pad

CONFIDENTIAL

Absolute Maximum Ratings

Parameter	Symbol	Ratings	Unit
Reverse Voltage	V_R	Not designed for reverse operation	V
Max. DC Forward Current (mA)	I_F	700	mA
Max. Peak Pulse Current (mA)	I_{Pulse}	1000 ^[1]	mA
Junction Temperature	T_J	125	°C
Thermal Resistance (Junction to Soldering)	R_{th}	12	°C/W
Operating Temperature	T_{opr}	-40 ~ +115	
Storage Temperature	T_{stg}	-40 ~ +120	
ESD Sensitivity	ESD_{HBM}	8000	V
Max. Soldering Temperature	T_{Sol}	260	°C
Max. Allowable Reflow Cycles	N/A	3	cycles

Notes:

1. Duty cycle = 1/10@1KHZ .

CONFIDENTIAL

PN of the EAHP2016-AM series



Order Code	Minimum Luminous Flux (lm)	Typical Luminous Flux (lm)	Color Bin	Forward Voltage (V)	Current (mA)	Typical Viewing Angle (degrees) $2\theta_{1/2}$
EAHP2016YA0-AM	100	125	Y1	2.95-4.15	700	130

Notes:

1. Luminous flux measurement tolerance: $\pm 10\%$.
2. The data of luminous flux measured at thermal pad=25
3. Typical luminous flux or light output performance is operated within the condition guided by this datasheet.
4. View angle tolerance is $\pm 5^\circ$

CONFIDENTIAL

Product Binning

Luminous Flux Bins

Group	Bin	Minimum Photometric Flux (lm)	Maximum Photometric Flux (lm)
E	1	4	5
	2	5	6
	3	6	8
	4	8	10
	5	10	13
	6	13	17
	7	17	20
	8	20	23
	9	23	27
Group	Bin	Minimum Photometric Flux (lm)	Maximum Photometric Flux (lm)
F	1	27	33
	2	33	39
	3	39	45
	4	45	52
	5	52	60
	6	60	70
	7	70	80
	8	80	90
	9	90	100

Group	Bin	Minimum Photometric Flux (lm)	Maximum Photometric Flux (lm)
J	1	100	110
	2	110	120
	3	120	130
	4	130	140
	5	140	150
	6	150	160
	7	160	180
	8	180	200
	9	200	225
Group	Bin	Minimum Photometric Flux (lm)	Maximum Photometric Flux (lm)
K	1	225	250
	2	250	275
	3	275	300
	4	300	325
	5	325	350
	6	350	375
	7	375	400
	8	400	425
	9	425	450

Notes:

1. Luminous flux measurement tolerance: $\pm 10\%$.

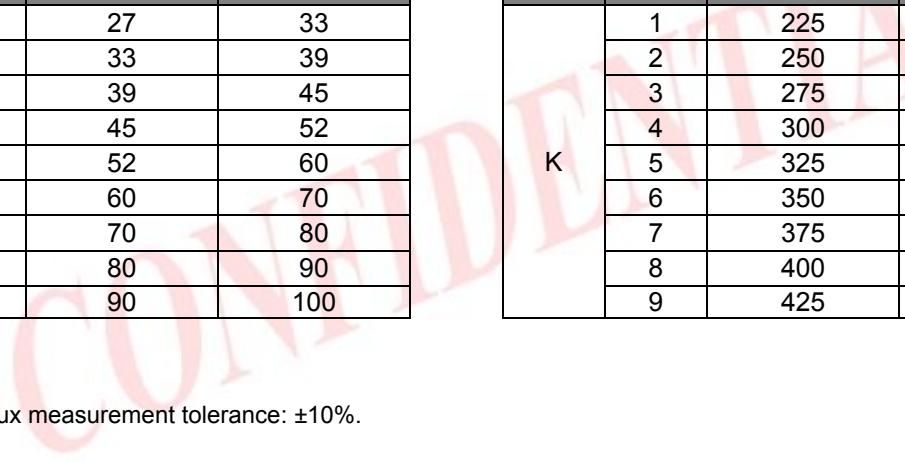

Amber Bin Structure

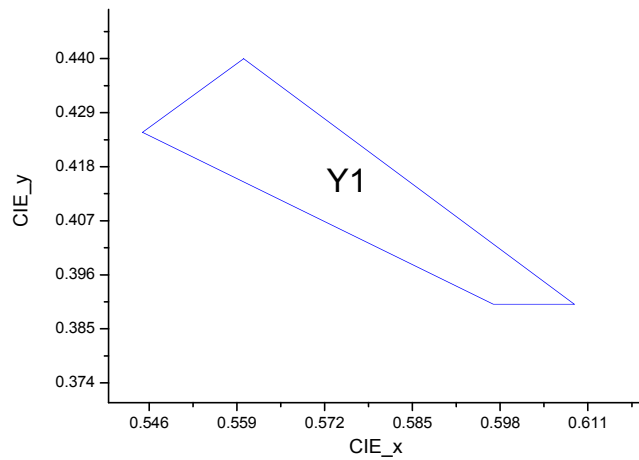

Amber Bin Coordinates

Bin	CIE X	CIE Y
Y1	0.5600	0.4400
	0.5450	0.4250
	0.5970	0.3900
	0.6090	0.3900

Notes:

1. Color coordinates measurement allowance: ± 0.01 .

Forward Voltage Bins

Bin	Minimum Forward Voltage (V)	Maximum Forward Voltage (V)
2932	2.95	3.25
3235	3.25	3.55
3538	3.55	3.85
3841	3.85	4.15

Notes:

1. Forward voltage measurement tolerance: $\pm 0.1V$.
2. Forward voltage bins are defined at $I_F=700mA$ operation.

Mechanical Dimension

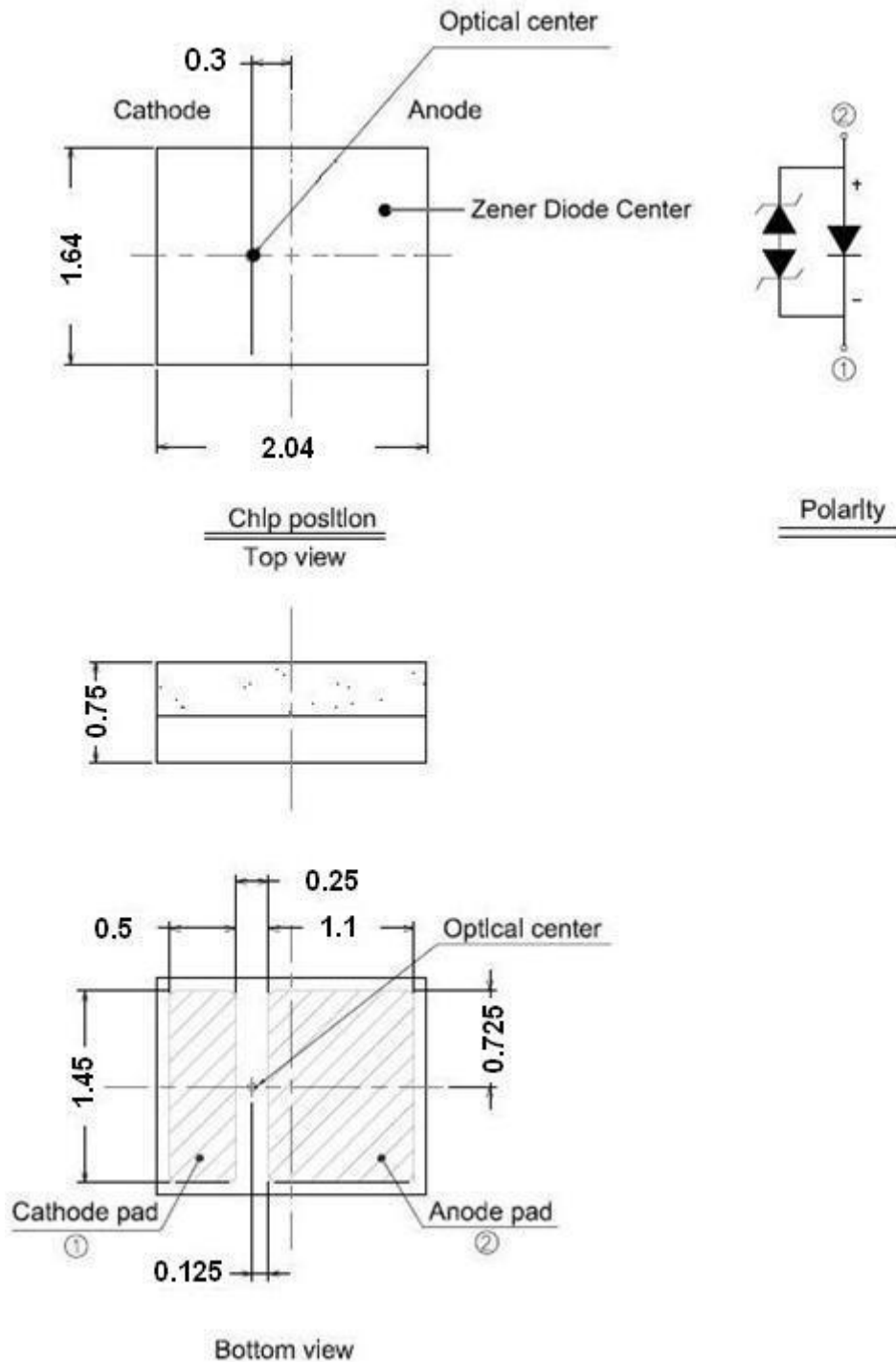

Notes:

1. Dimensions are in millimeters.
2. Tolerances unless mentioned are ± 0.1 mm.
3. The thermal pad is electrically unity from the Anode and contact pads.
4. Do not handle the device by the lens. Incorrect force applied to the lens may lead to the failure of devices.

Wavelength Characteristics Relative Spectral Distribution @ Solder Pad Temperature = 25

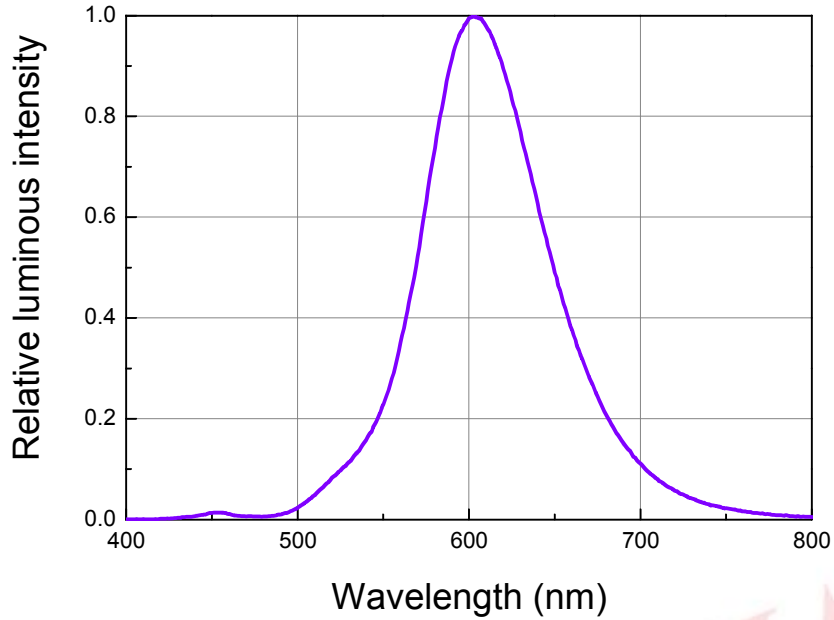

Forward Current Derating Curve @Solder Pad Temperature

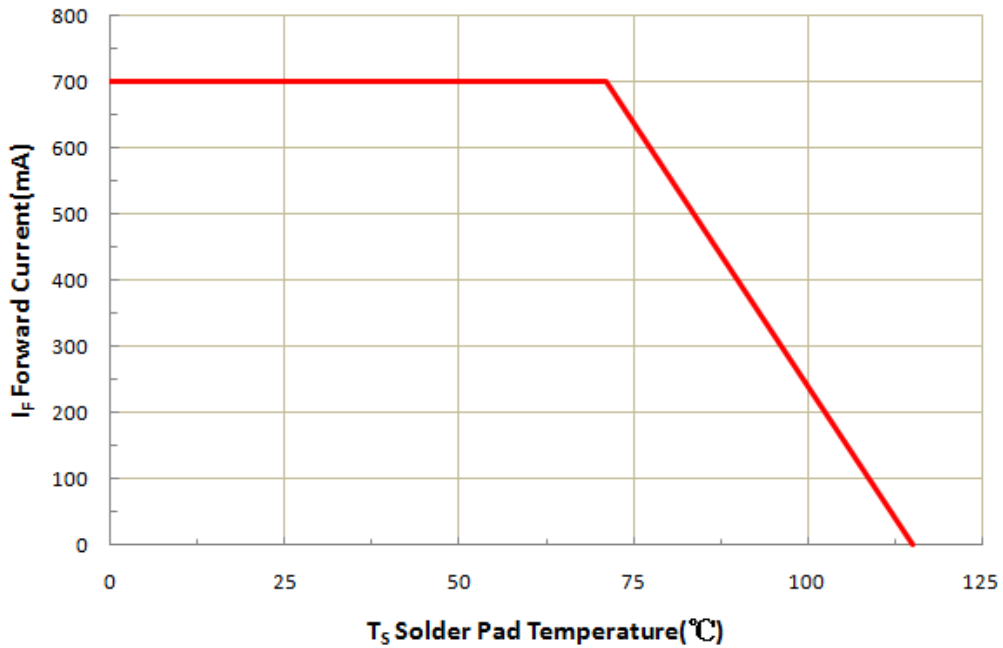

Color: PC-Amber

Forward Voltage vs. Forward Current
@ $T_s = 25^\circ\text{C}$, 50ms

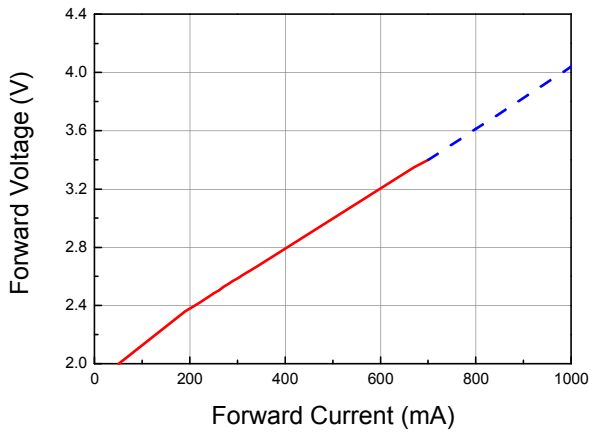

Typical Relative Luminous vs. Forward Current
@ $T_s = 25^\circ\text{C}$, 50ms

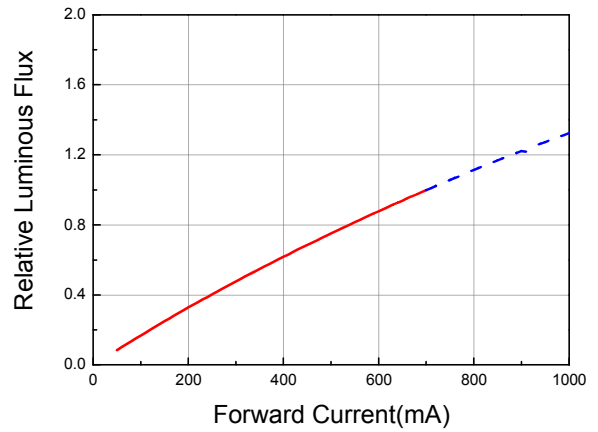

Chromaticity Coordinates Shift vs. Forward Current
@ $T_s = 25^\circ\text{C}$, 50ms

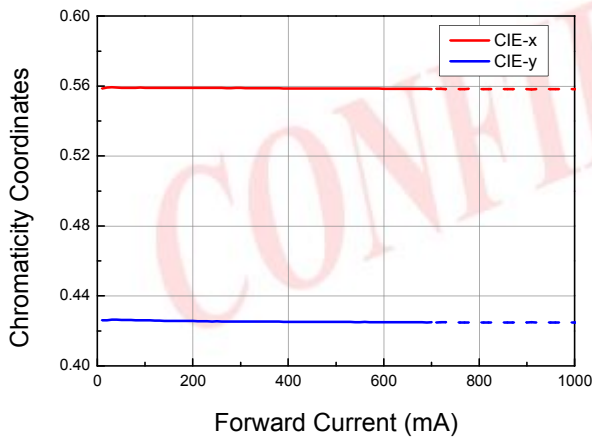

Relative Forward Voltage @ Junction Temperature

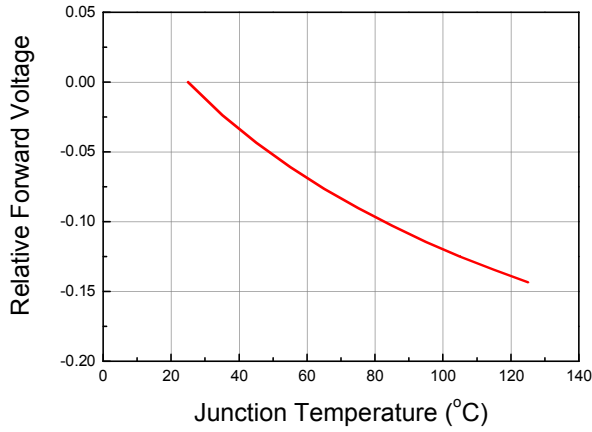

Relative Luminous Flux @ Junction Temperature

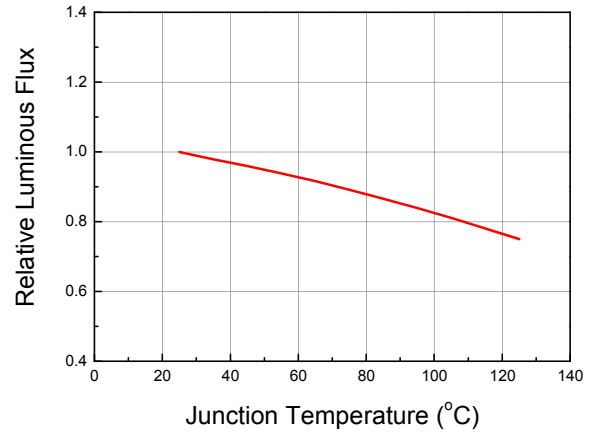

Chromaticity Coordinates Shift @ Junction Temperature

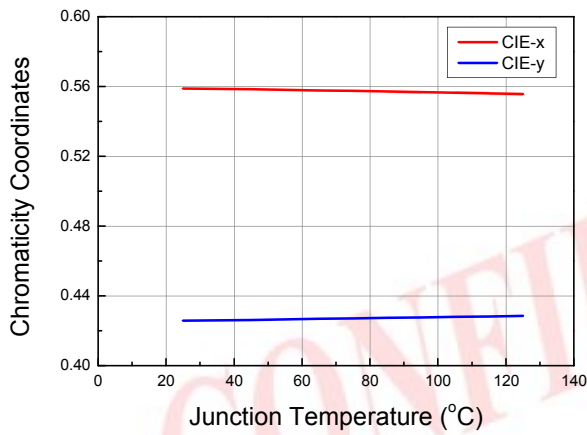

CONFIDENTIAL

Typical Radiation Patterns

Typical Diagram Characteristics of Radiation for Amber

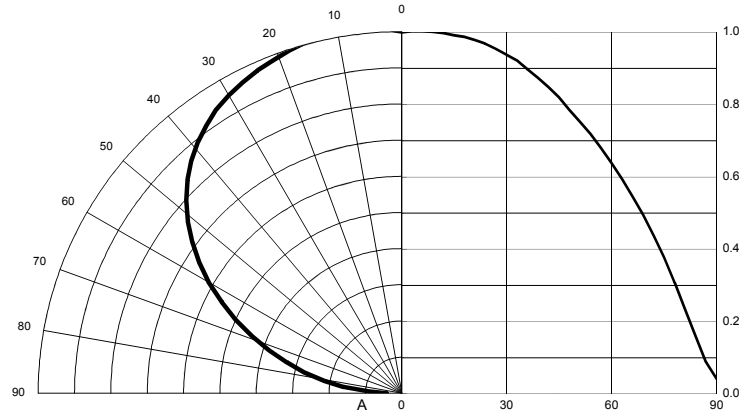

Notes:

1. $\theta_{1/2}$ is the off axis angle from lamp centerline where the luminous intensity is 1/2 of the peak value.
2. Viewing angle tolerance is $\pm 5^\circ$.

CONFIDENTIAL

Moisture Resistant Packing Materials

Product Labeling

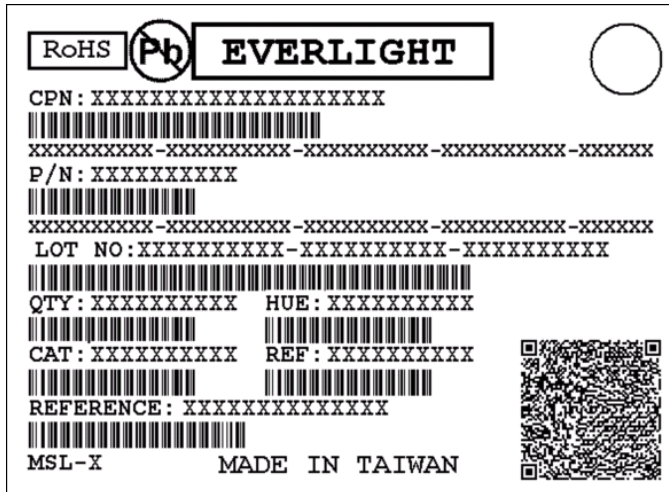

- CPN : Customer's Product Number
- P/N : Everlight Product Number
- LOT No : Lot Number
- QTY : Packing Quantity
- HUE : Color Bin
- CAT : Luminous Flux (Brightness) Bin
- REF : Forward Voltage Bin

Carrier Tape Dimensions: Loaded Quantity 2000 pcs Per Reel

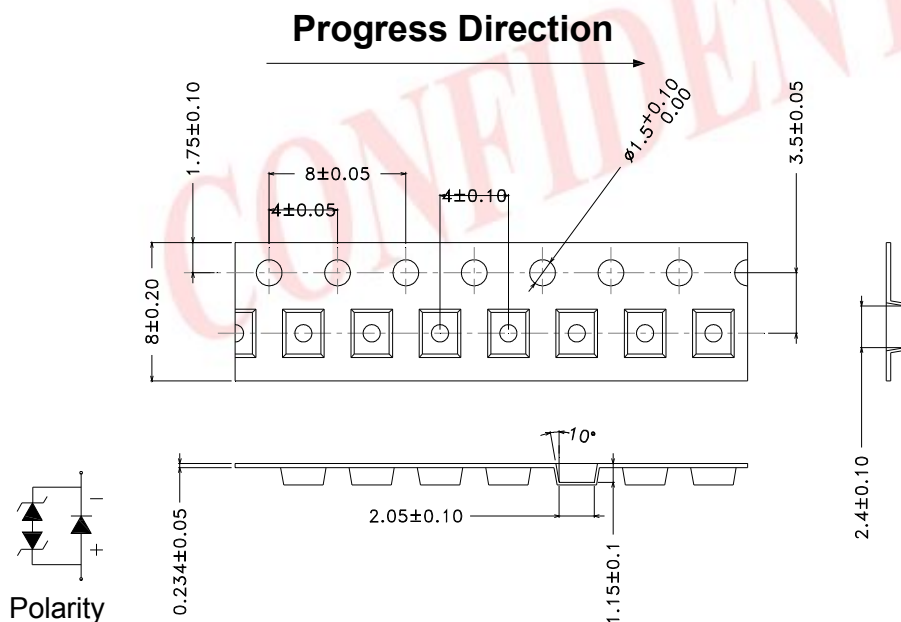

Notes:

1. Dimensions are in millimeters.
2. Tolerances for fixed dimensions are ± 0.1 mm.

Emitter Reel Dimensions

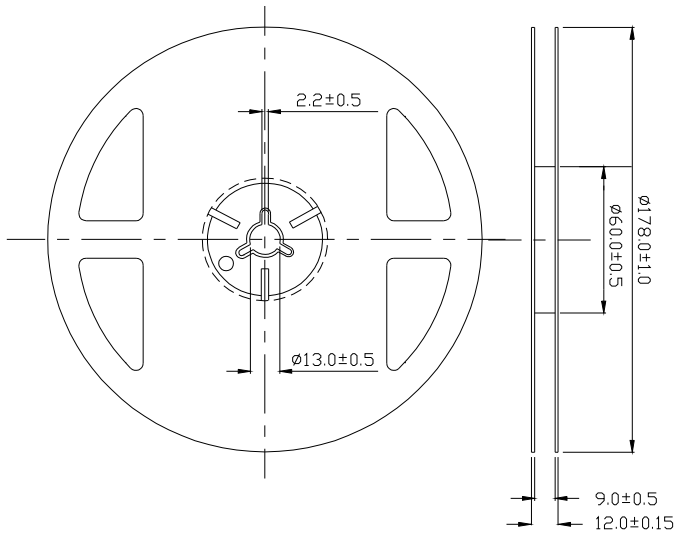

Notes:

1. Dimensions are
2. Tolerances unless mentioned are ± 0.1 mm.

Moisture Resistant Packing Process

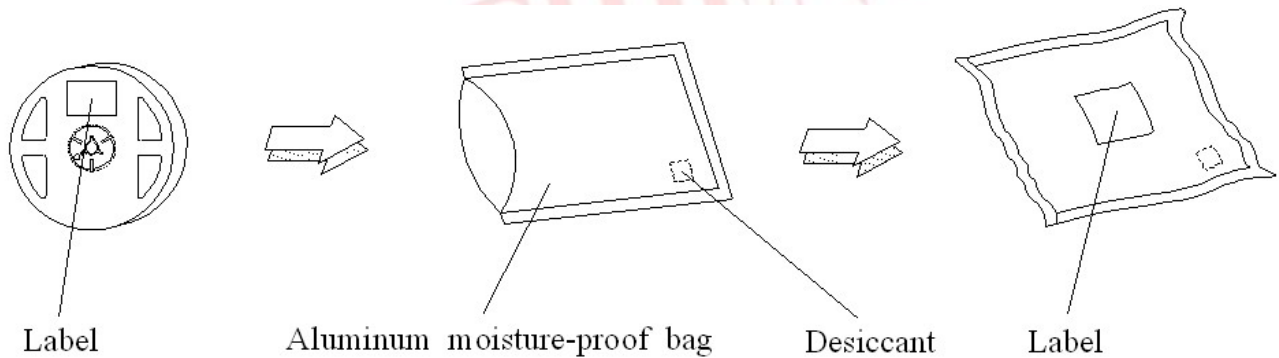

Notes:

1. Dimensions are in millimeters.
2. Tolerances unless mentioned are ± 0.1 mm.

Storage Conditions

Precautions for Use

Soldering Condition (Reference: IPC/JEDEC J-STD-020D)

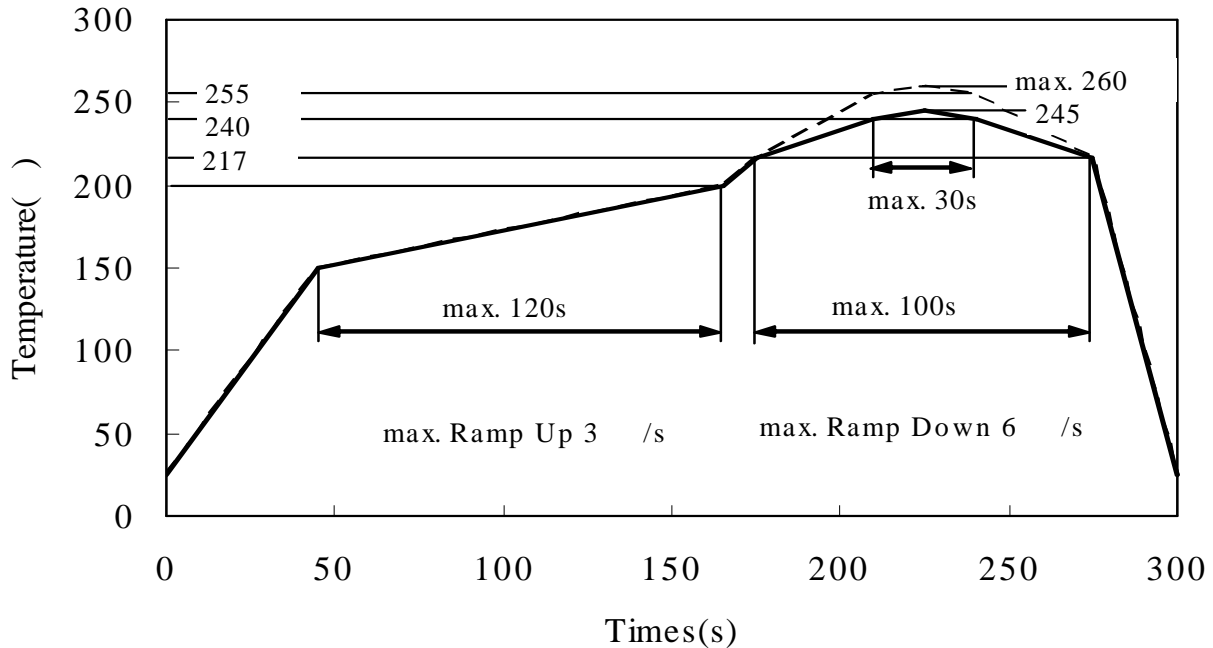

- Before the package is opened. The LEDs should be stored at 30°C or less and 85%RH or less after being shipped from Everlight and the storage life limits are 1 year. The LEDs can be stored up to 3 years if in a sealed container with a nitrogen atmosphere and moisture absorbent material.
- After opening the package: The LED's floor life is 1 year under 30 °C or less and 60%RH or less. The LED should be soldered within 168hrs (7days) after opening the package. If unused LEDs remain, it should be stored in moisture proof packages.
- If the moisture absorbent material (silica gel) has faded away or the LEDs have exceeded the storage time, baking treatment should be performed using the following conditions. Baking treatment: 60±5 °C for 24 hours.

Handling

Do not put mechanical stress on the LED.

Never touch the optical surface with finger or sharp object. The LED surface could be soiled or damaged, which could affect the optical performance of the LED.

In low-humidity work environment, please keep handling the LEDs with appropriate ESD grounding.

It is recommended to handle the LED with powder-less latex gloves.

Manual Handling

- When handling the product, do not apply direct pressure on the optical surface.
- Do not touch the resin with tweezers to avoid scratching or other damage.

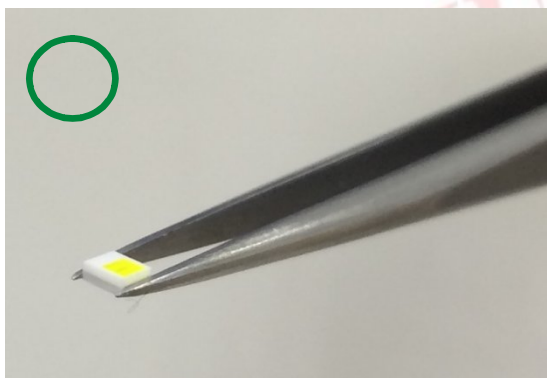
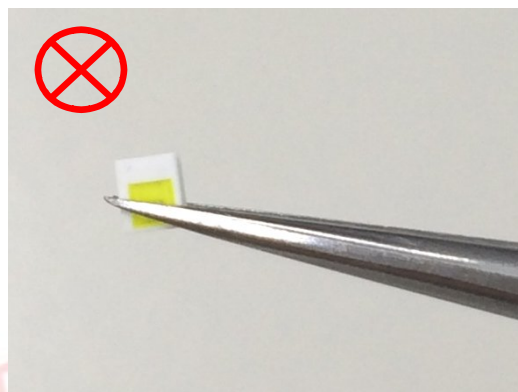
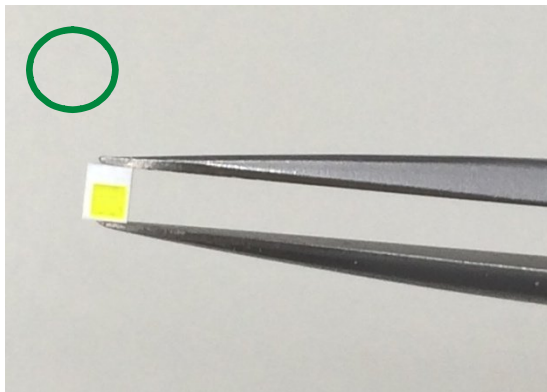

Revision History

Current version: 2015/09/08
Device No: DHE-000XXXX
Version. 1

Page	Subjects (major change in previous version)	Date of change

CONFIDENTIAL