

IS32LT3120

DUAL CHANNEL, LINEAR LED DRIVER WITH FADE IN/FADE OUT

Preliminary Information
August 2014

GENERAL DESCRIPTION

The IS32LT3120 is a linear programmable current regulator consisting of 2 output channels capable of up to 200mA each. Each channel features an ON/OFF input pin to toggle the channel between the OFF condition and the source condition.

A single external resistor programs the current level for both of the channels, while a separate, single resistor programs the fade in and fade out rate for both channels.

The device integrates a 63 steps fade in and fade out algorithm (Gamma correction) which causes the output LED current to gradually ramp up to the full source value after the channel's control pin is pulsed. The same controller causes the LED current to gradually ramp down to zero if the channel's input control pin is pulsed while the output channel is on. The LED current output can be controlled by a momentary contact switch or logic level signal.

The IS32LT3120 is targeted at the automotive market with end applications to include map and dome lighting as well as exterior accent lighting. For 12V automotive applications the low dropout driver can support 1 to 3 LEDs per channel. It is offered in a small thermally enhanced SOP-8-EP packages.

FEATURES

- Dual output channels can source up to 200mA each
- Independent on/off control for each channel
-Inputs are debounced
- Programmable current via a single external resistor
- Programmable fade in, fade out via external resistor
- Pull down resistor value sets fade speed
- Gamma corrected fade in/out algorithm
- Fault Protection:
- LED string shorted to GND
- Over temperature
- SOP-8-EP packages
- Automotive Grade - AEC-Q100 (pending)
- Operating temperature range from -40°C ~ +125°C

APPLICATIONS

- Automotive Interior:
- Map light
- Dome lighting
- Puddle lamp in doors
- Glove box
- Vanity mirror

TYPICAL APPLICATION CIRCUIT

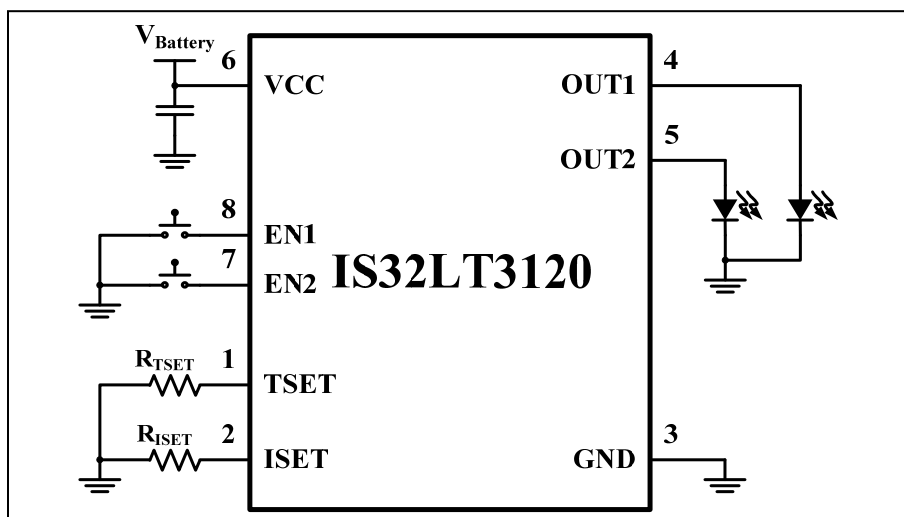
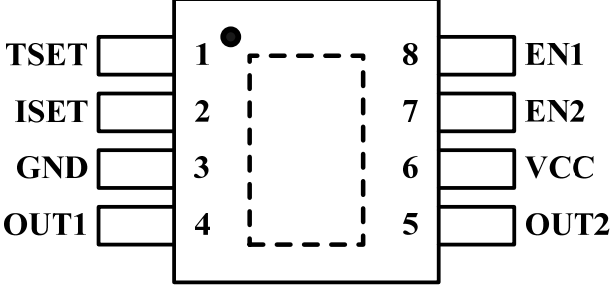

Figure 1 Typical Application Circuit

IS32LT3120

PIN CONFIGURATION

Package	Pin Configuration (Top view)
SOP-8-EP	

PIN DESCRIPTION

No.	Pin	Description
1	TSET	Timing control for the fade in and fade out feature. Connect a resistor between this pin and GND to set the fade in and fade out time. Connect this pin directly to ground to disable the fade function for instant on/off.
2	ISET	Output current setting for both channel 1 and channel 2. Connect a resistor between this pin and GND to set the maximum output current.
3	GND	Ground pin for the device.
4	OUT1	Output current source channel 1.
5	OUT2	Output current source channel 2.
6	VCC	Power supply input pin.
7	EN2	Internally debounced input pin for control of channel 2. Momentary contact will toggle the state of the corresponding OUT2 LED. Pin condition is ignored until completion of fade in or fade out function.
8	EN1	Internally debounced input pin for control of channel 1. Momentary contact will toggle the state of the corresponding OUT1 LED. Pin condition is ignored until completion of fade in or fade out function.
	Thermal Pad	Connect to GND.



IS32LT3120

ORDERING INFORMATION

AUTOMOTIVE RANGE: -40°C TO +125°C

Order Part No.	Package	QTY/Reel
IS32LT3120-GRLA3-TR	SOP-8-EP, Lead-free	2500

Copyright © 2014 Integrated Silicon Solution, Inc. All rights reserved. ISSI reserves the right to make changes to this specification and its products at any time without notice. ISSI assumes no liability arising out of the application or use of any information, products or services described herein. Customers are advised to obtain the latest version of this device specification before relying on any published information and before placing orders for products.

Integrated Silicon Solution, Inc. does not recommend the use of any of its products in life support applications where the failure or malfunction of the product can reasonably be expected to cause failure of the life support system or to significantly affect its safety or effectiveness. Products are not authorized for use in such applications unless Integrated Silicon Solution, Inc. receives written assurance to its satisfaction, that:

- a.) the risk of injury or damage has been minimized;
- b.) the user assume all such risks; and
- c.) potential liability of Integrated Silicon Solution, Inc is adequately protected under the circumstances

IS32LT3120

ABSOLUTE MAXIMUM RATINGS

VCC, OUT1, OUT2	-0.3V ~ +50V
EN1, EN2, ISET, TSET	-0.3V ~ +7.0V
Ambient operating temperature, T _A	-40°C ~ +125°C
Maximum continuous junction temperature, T _{J(MAX)}	150°C
Storage temperature range, T _{STG}	-55°C ~ +150°C
Maximum power dissipation, P _{DMAX}	2.86W
ESD (HBM)	2kV
ESD (CDM)	750V

Note:

Stresses beyond those listed under "Absolute Maximum Ratings" may cause permanent damage to the device. These are stress ratings only and functional operation of the device at these or any other condition beyond those indicated in the operational sections of the specifications is not implied. Exposure to absolute maximum rating conditions for extended periods may affect device reliability.

THERMAL CHARACTERISTICS

Characteristic	Test Conditions	Value
Package Thermal Resistance (Junction to Ambient), R _{θJA}	On 4-layer PCB based on JEDEC standard	35°C/W
	On 2-layer generic test PCB with 0.8 in ² copper	62°C/W
Package Thermal Resistance (Junction to Pad), R _{θJP}		2°C/W

ELECTRICAL CHARACTERISTICS

T_J = -40°C ~ +125°C, V_{CC}=12V, the detail refer to each condition description. Typical values are at T_J = 25°C.

Symbol	Parameter	Condition	Min.	Typ.	Max.	Unit
V _{CC}	Supply voltage range		6		45	V
V _{DO}	Minimum dropout voltage	V _{CC} - V _{OUTx} , I _{OUTx} = -200mA			TBD	mV
		V _{CC} - V _{OUTx} , I _{OUTx} = -100mA			700	mV
I _{CC}	Quiescent supply current	OUT1 and OUT2 is shutdown	0.1		1	mA
		I _{SET} =20kΩ, enable. OUTx connected to VCC		3.6		mA
t _{ON}	Startup time	V _{CC} > 6V to I _{OUTx} < -5mA (Note 3)			400	μs
I _{OUT_RNG}	Output current range		20		200	mA
I _{OUT_LIM}	Output limit current	OUTx sourcing current, V _{ISET} = 0V		260	310	mA
I _{OUT}	Output current (Note1,2,4)	I _{SET} = 20kΩ, T _J = 25°C	97	100	103	mA
		I _{SET} = 20kΩ, -40°C < T _J < +105°C	95	100	105	
		I _{SET} = 20kΩ, T _J = 125°C		86		
E _{IOUT}	Absolute current accuracy (Note1,2)	-50mA ≤ I _{OUTx} < -20mA, -40°C < T _J < +105°C	-8		8	%
		-200mA < I _{OUTx} < -50mA, -40°C < T _J < +105°C	-6		6	%
E _{IOUTM}	Channel to channel current matching (Note1,2)	I _{OUTx} = -100mA, T _J = 25°C			2	%
		I _{OUTx} = -100mA, -40°C < T _J < +105°C			4	%
g _{LINE}	Output current line regulation	I _{OUTx} = -50mA, 6V < V _{CC} < 45V, V _{OUT} = V _{CC} - 2V (Note 3)	-0.2		0.2	mA/V
g _{LOAD}	Output current load regulation	2.5V < V _{OUTx} < V _{CC} - 2.0V, I _{OUTx} = -50mA (Note 3)	-0.2		0.2	mA/V
t _{SL}	Current slew time	Current rise/fall between 0%~100% V _{TSET} = 0V	45	70	100	μs

IS32LT3120

ELECTRICAL CHARACTERISTICS (CONTINUE) (TBD)

$T_J = -40^{\circ}\text{C} \sim +125^{\circ}\text{C}$, $V_{CC}=12\text{V}$, the detail refer to each condition description. Typical values are at $T_J = 25^{\circ}\text{C}$.

Symbol	Parameter	Condition	Min.	Typ.	Max.	Unit
Logic Input TSET						
V_{TSET}	Voltage reference			1		V
T_{ACC}	fade timing accuracy	*Neglecting the R_{TSET} Tolerance* $R_{TSET}=100\text{k}\Omega$, $T_J = 25^{\circ}\text{C}$	-5		5	%
Logic Input ENx						
V_{IL}	Input low voltage				0.8	V
V_{IH}	Input high voltage		2			V
V_{IN_HY}	Input hysteresis	(Note 3)	150	350		mV
R_{PU}	Pull-up resistor	(Note 3)		50		k Ω
I_{PU}	Pull-up current		55	75	95	μA
t_{SW}	ENx input debounce time	ENx pin must not change state within this time to be interpreted as a switch press or release	25	37	50	ms
Protection						
V_{SCD}	Short detect voltage	Measured at OUTx	1.2		1.8	V
V_{SC_HY}	Short detect voltage hysteresis	$V_{SCR} - V_{SCD}$ (Note 3)		220		mV
t_{FD}	Fault detect persistence time	(Note 3)		5		ms
T_{RO}	Thermal roll off threshold	(Note 3)		115		$^{\circ}\text{C}$
T_{SD}	Thermal shutdown threshold	Temperature increasing (Note 3)		155		$^{\circ}\text{C}$
T_{HY}	Over temperature hysteresis	Recovery = $T_{SHT} - T_{J_HY}$ (Note 3)		20		$^{\circ}\text{C}$

Note 1: Output current accuracy is computed as $100 \times [1 - 2 \times I_{OUTx} / (I_{OUT1} + I_{OUT2})]$. Output current channel to channel match is computed as $100 \times [\text{Max} (|I_{OUTx} - I_{OUT(AV)} |) / I_{OUT(AV)}]$, where $I_{OUT(AV)}$ is the average current of all active outputs.

Note 2: Output current accuracy is not intended to be guaranteed at output voltages less than 1.8V.

Note 3: Guaranteed by design.

Note 4: As a result of thermal roll off function, I_{OUT} is reduced at the temperature 125°C .

IS32LT3120

TYPICAL PERFORMANCE CHARACTERISTICS

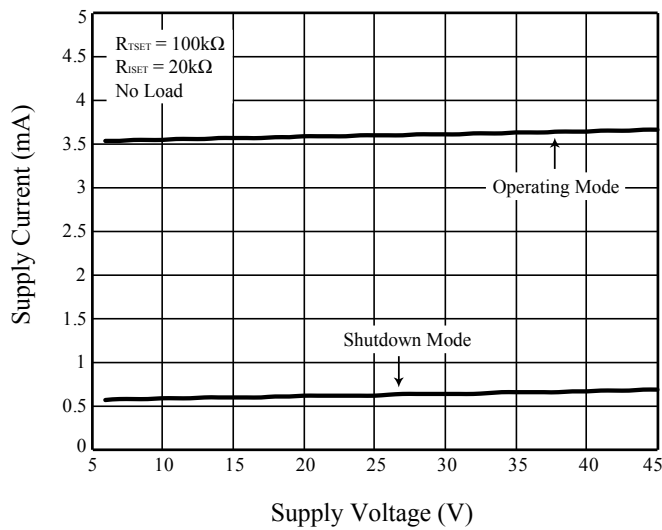

Figure 2 Supply Current vs. Supply Voltage

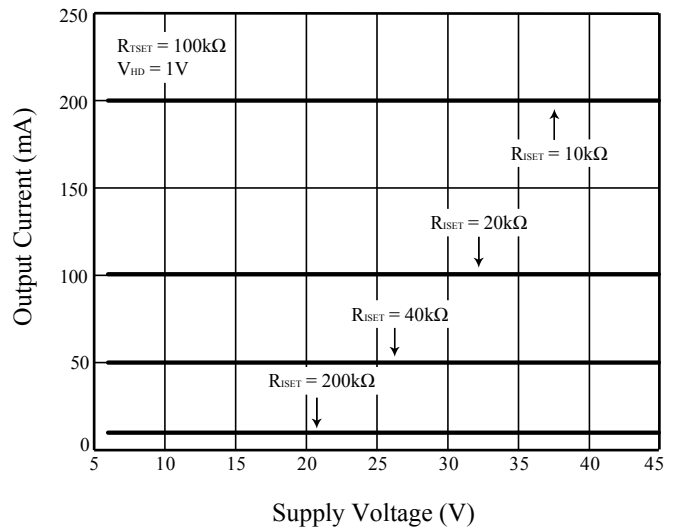

Figure 3 Output Current vs. Supply Voltage

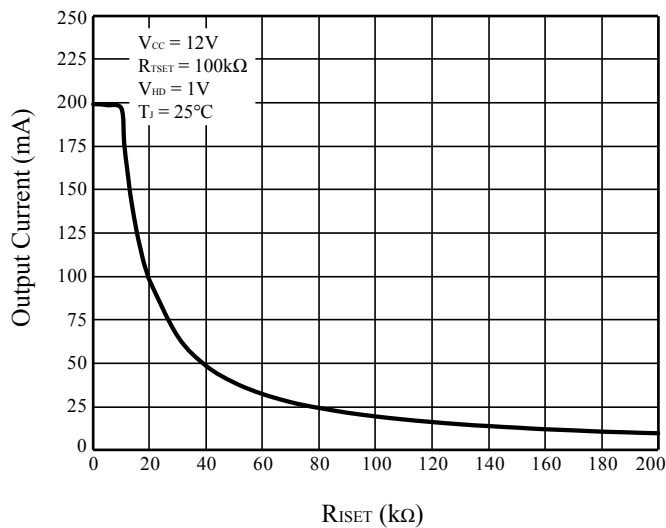

Figure 4 Output Current vs. R_{ISET}

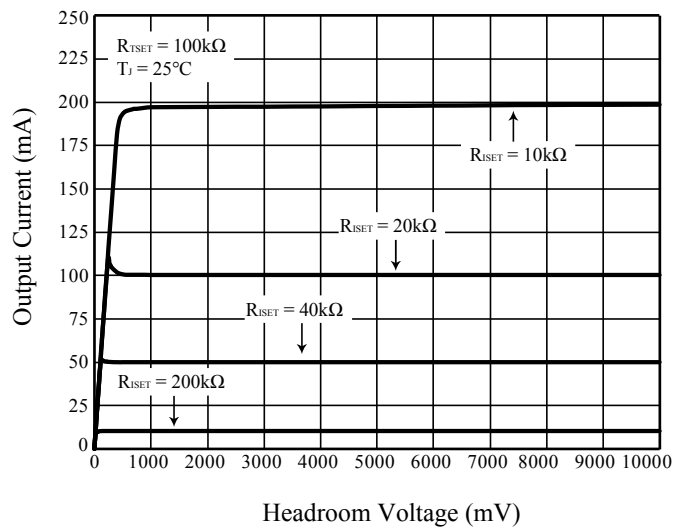

Figure 5 Output Current vs. Headroom Voltage

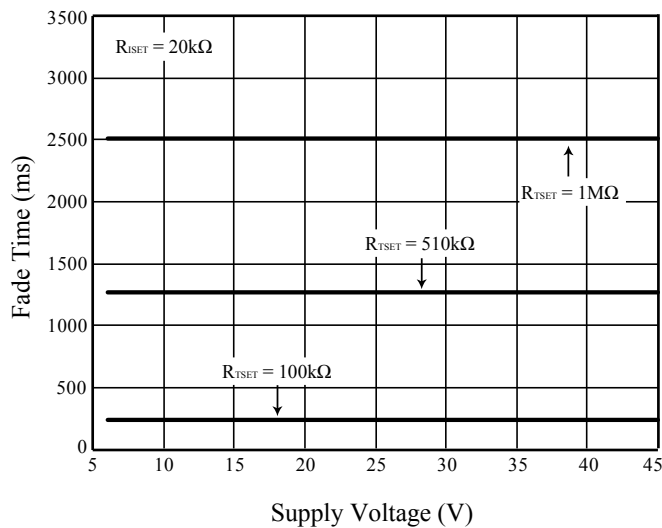

Figure 6 Fade Time vs. Supply Voltage

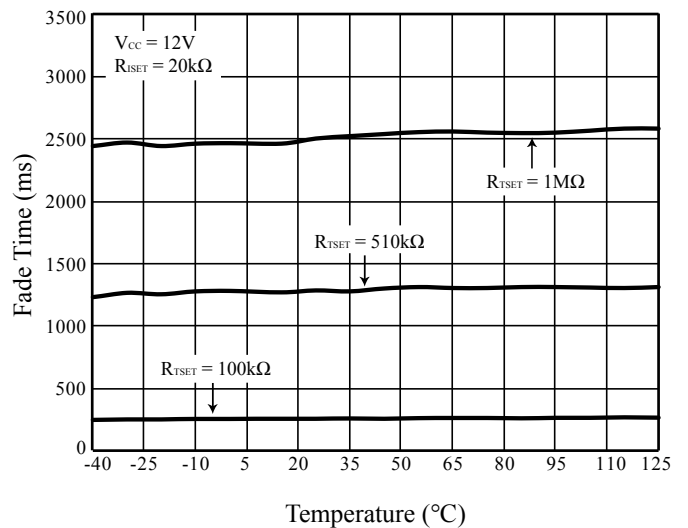

Figure 7 Fade Time vs. Temperature

IS32LT3120

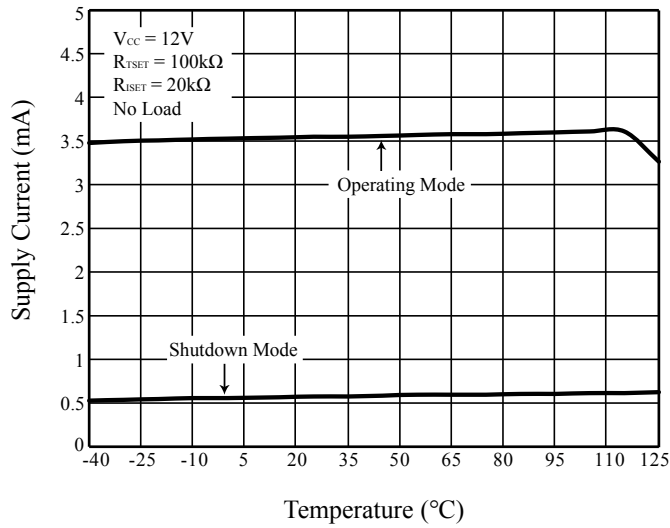

Figure 8 Supply Current vs. Temperature

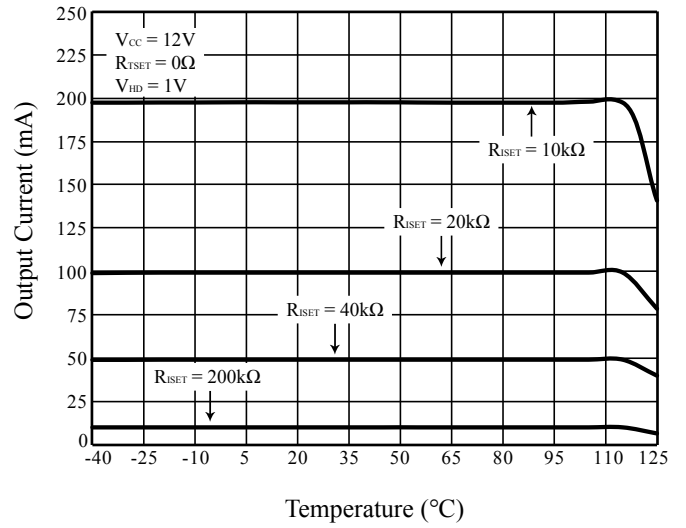

Figure 9 Output Current vs. Temperature

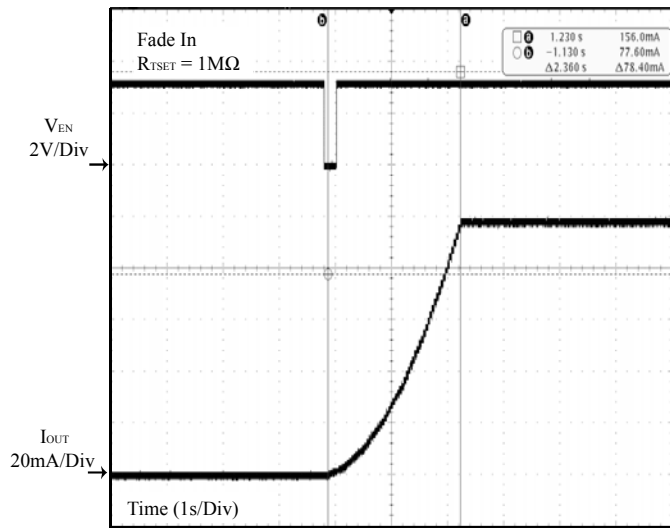

Figure 10 V_{EN} vs. I_{OUT}

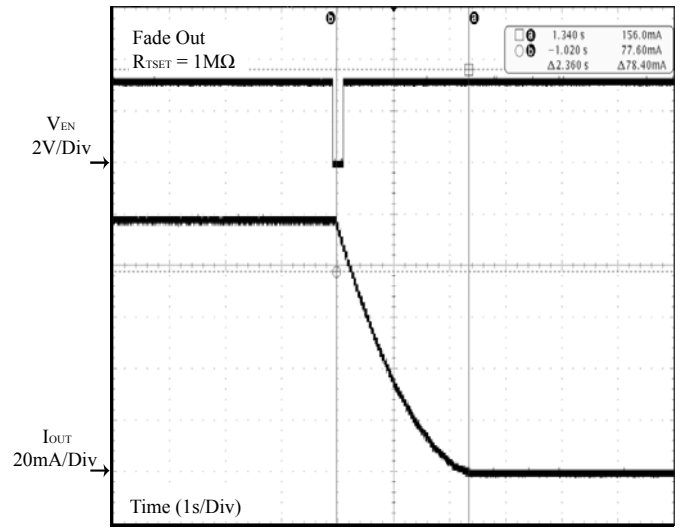

Figure 11 V_{EN} vs. I_{OUT}

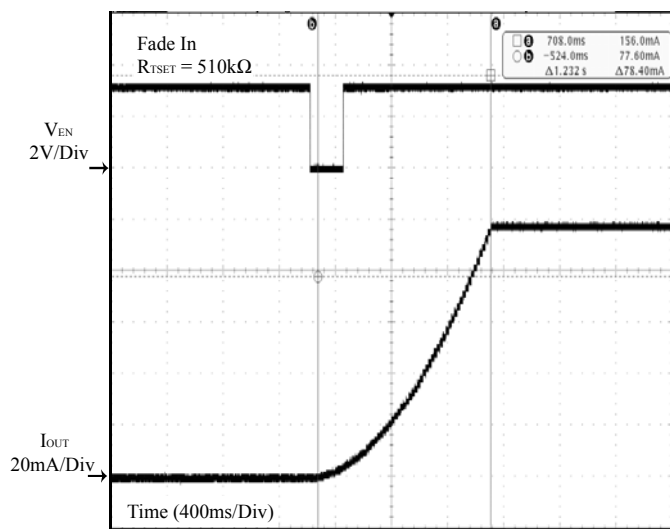

Figure 12 V_{EN} vs. I_{OUT}

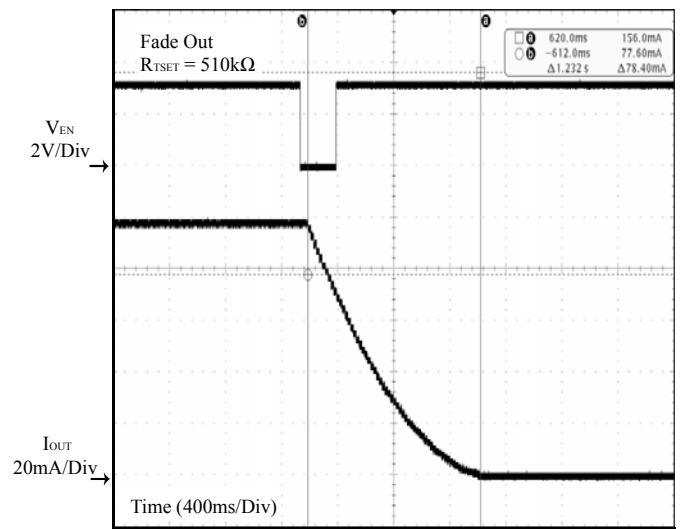

Figure 13 V_{EN} vs. I_{OUT}

IS32LT3120

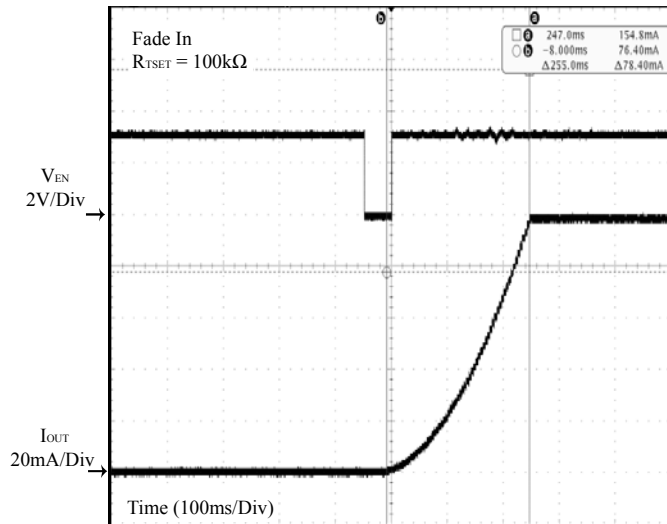

Figure 14 V_{EN} VS. I_{OUT}

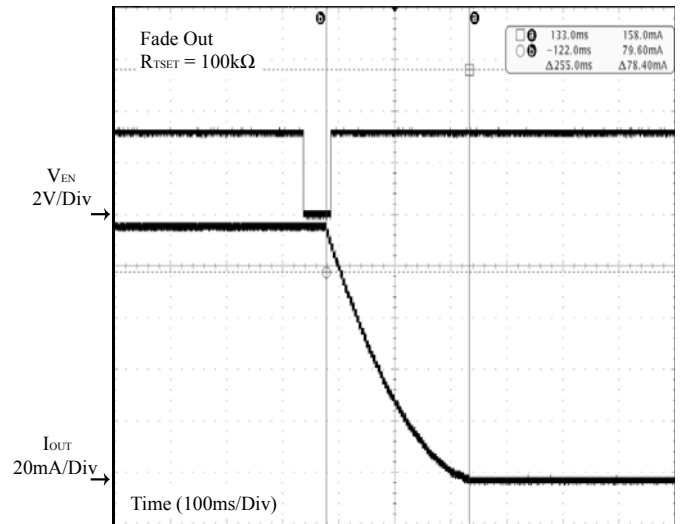

Figure 15 V_{EN} VS. I_{OUT}

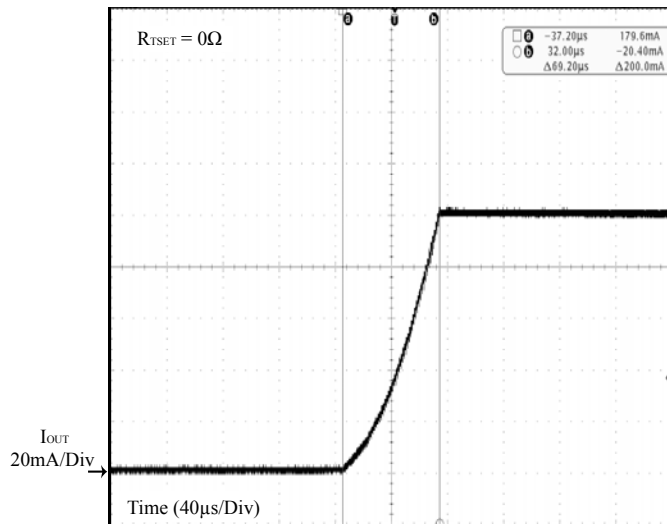

Figure 16 Instant on

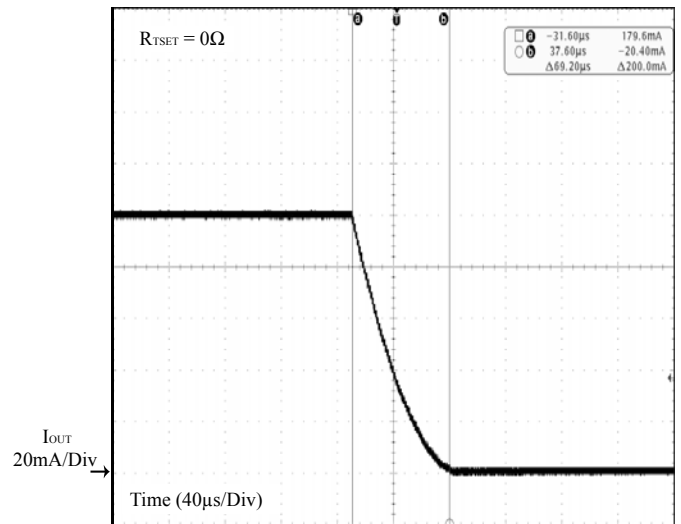
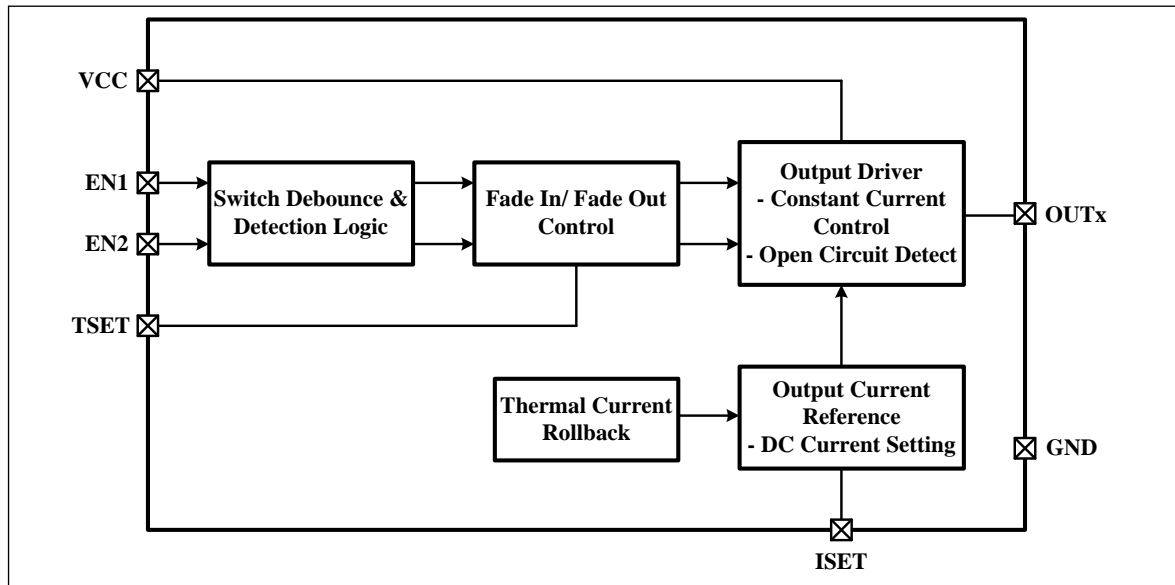

Figure 17 Instant Off

IS32LT3120

FUNCTIONAL BLOCK DIAGRAM



APPLICATION INFORMATION

The IS32LT3120 is a 2-channel linear current driver optimized to drive an automotive interior map light, or other interior lamp which is frequently toggled between the on and off condition. The device integrates a separate input control for each channel allowing for independent on/off operation of either channel. In addition, a programmable fade in and fade out feature is integrated into each channel's control block to allow the end customer maximum flexibility in setting up their light timing requirements.

The device LED current outputs can be connected in parallel or left unused as required. The regulated LED current (up to 200mA) from each channel output is set by a single reference resistor (R_{ISET}). Current is matched in each string eliminating the need for ballast resistors. (Note: When connecting the outputs in parallel, both ENx inputs should also be connected together so that both OUTx channels are controlled by the same signal.)

OUTPUT CURRENT SETTING

A single programming resistor (R_{ISET}) controls the maximum output current for both output channels simultaneously. The programming resistor may be computed using the following Equation (1):

$$R_{ISET} = \frac{2000}{I_{SET}} \quad (1)$$

$$(10k\Omega \leq R_{ISET} \leq 100k\Omega)$$

The device is protected from an output overcurrent condition caused by an accidental short circuit of the ISET pin, by internally limiting the maximum current in the event of an ISET short circuit to 260mA.

EN PIN OPERATION

The EN inputs to the device include internal pull-up sources so that no external components are required to provide the input high level to the pin.

Both output channels power up in the 'OFF' condition. Toggling the EN pin from high to low on a given channel for a period of time that exceeds the debounce time will cause that channel's output to toggle from the OFF condition to the source condition. When this happens, the output current of the channel gradually ramps up from zero to the programmed value (set by R_{ISET}) over the time set by the resistor (R_{TSET}) attached to the ISET pin. Conversely, if a channel is already in the source condition, and that channel's EN pin is toggled low, then the output current shall begin to ramp down towards zero in the time period as programmed by the resistor (R_{TSET}) attached to the TSET pin.

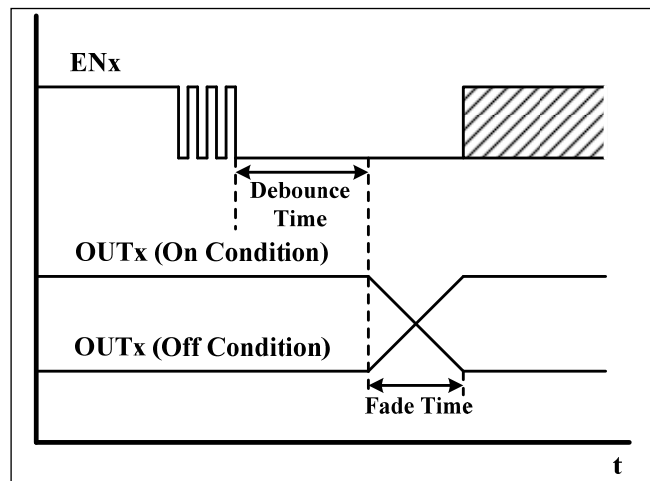

Figure 18 ENx Debounced

Debounce - Output control is provided by a debounced switch input, providing an ON/OFF toggle action for various switch or button characteristics. An internal debounce circuit will condition the input signal so a single press of the mechanical switch doesn't appear like multiple presses. The ENx inputs are debounced by typically 37ms.

Note: The debounce time applies to both falling and rising edges of the ENx signal.

FADE IN AND FADE OUT

When an ENx channel is turned on (pulled low), the output current of the channel shall gradually ramp up from zero to the final value as programmed by the resistor (R_{ISET}) connected to the ISET pin. The time period over which the ramping happens is determined by the resistor (R_{TSET}) connected to the TSET pin. The output current shall ramp up (or down) in 63 steps, with integrated gamma correction for an extremely linear ramping of the luminous output of the LED bulb.

SETTING THE FADE TIME

The fade time, either in or out, for both channels is the same, and is set by a single external programming resistor (R_{TSET}). The fade time is programmable by Equation (2):

$$t \approx R_{TSET} \times 2.5\mu s \quad (2)$$

For example, $R_{TSET}=100k\Omega$, fade time is about 0.25s.

Note: In order to get the optimized effect, the recommended fading time is between 1.5s ($R_{TSET}=600k\Omega$) and 0.25s ($R_{TSET}=100k\Omega$).

If the TSET pin is tied directly to GND, the fade in/out function is canceled and the ramp time is about 73 μ s, or 'instant on'. However, the debounce feature of the ENx pin is not disabled.

IS32LT3120

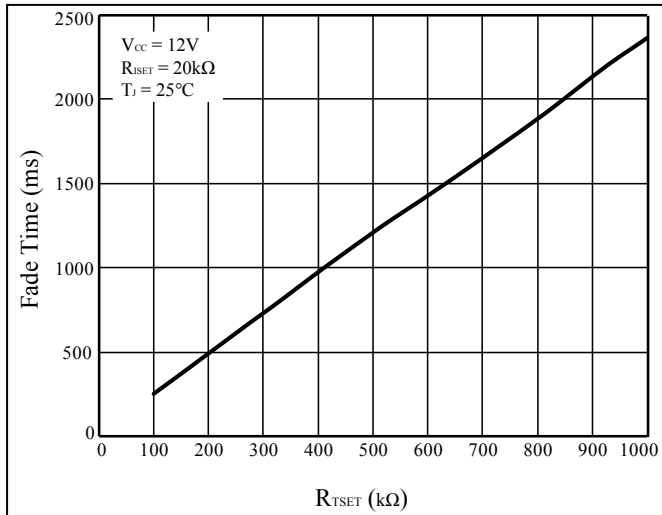

Figure 19 Fade Time vs. R_{TSET}

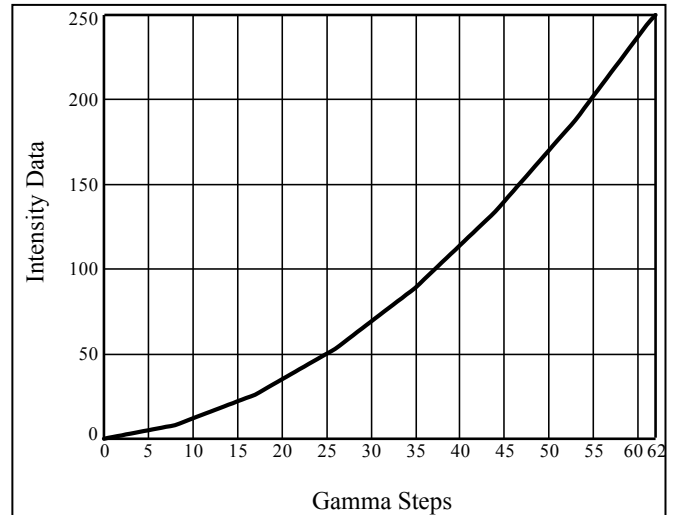

Figure 20 Gamma Correction(63 Steps)

GAMMA CORRECTION

In order to perform a better visual LED breathing effect we recommend using a gamma corrected value to set the LED intensity. This results in a reduced number of steps for the LED intensity setting, but causes the change in intensity to appear more linear to the human eye.

Gamma correction, also known as gamma compression or encoding, is used to encode linear luminance to match the non-linear characteristics of display. Gamma correction will vary the step size of the current such that the fading of the light appears linear to the human eye. Even though there may be 250 linear steps for the fading algorithm, when gamma corrected, the actual number of steps could be as low as 63.

Table 1 63 Gamma Steps With 250 Linear Steps

C(0)	C(1)	C(2)	C(3)	C(4)	C(5)	C(6)	C(7)
0	1	2	3	4	5	6	7
C(8)	C(9)	C(10)	C(11)	C(12)	C(13)	C(14)	C(15)
8	10	12	14	16	18	20	22
C(16)	C(17)	C(18)	C(19)	C(20)	C(21)	C(22)	C(23)
24	26	29	32	35	38	41	44
C(24)	C(25)	C(26)	C(27)	C(28)	C(29)	C(30)	C(31)
47	50	53	57	61	65	69	73
C(32)	C(33)	C(34)	C(35)	C(36)	C(37)	C(38)	C(39)
77	81	85	89	94	99	104	109
C(40)	C(41)	C(42)	C(43)	C(44)	C(45)	C(46)	C(47)
114	119	124	129	134	140	146	152
C(48)	C(49)	C(50)	C(51)	C(52)	C(53)	C(54)	C(55)
158	164	170	176	182	188	195	202
C(56)	C(57)	C(58)	C(59)	C(60)	C(61)	C(62)	
209	216	223	230	237	244	250	

FAULT DETECTION

An output shorted to GND fault is detected if the output voltage on a channel drops below the low voltage threshold V_{SCD} and remains below the threshold for t_{FD} . The channel (OUTx) with the short condition will reduce its output current to 20% of I_{SET} .

When short condition is removed, output current will recover to original value.

When output current is larger than limit value, about 260mA, the output current will be clamped. When the open fault condition is recovered, there will be a large current pulse about 10 μ s.

OVERTEMPERATURE PROTECTION

The device features an integrated thermal rollback feature which will reduce the output current of both channels in a linear fashion if the silicon temperature exceeds 125°C (Typical). In the event that the die temperature continues to increase, the device will enter thermal shutdown if the temperature exceeds 155°C.

THERMAL ROLLOFF

The output current of both channels will be equal to the set value so long as the die temperature of the IC remains below 125°C (Typical). If the die temperature exceeds this threshold, the output current of the device will begin to reduce at a rate of 3%/°C.

The roll off slope is related to I_{SET} value. When $I_{SET}=20$ mA, the roll off slope is about 3.7%. When $I_{SET}=200$ mA, the roll off slope is about 2.2%.

THERMAL SHUTDOWN

In the event that the die temperature exceeds 155°C, both output channels will go to the 'OFF' state. At this point, the IC presumably begins to cool off. Any attempt to toggle one or both of the channels back to the source condition before the IC cooled to < 135°C will be blocked and the IC will not be allowed to restart.

IS32LT3120

THERMAL CONSIDERATIONS

The package thermal resistance, $R_{\theta JA}$, determines the amount of heat that can pass from the silicon die to the surrounding ambient environment. The $R_{\theta JA}$ is a measure of the temperature rise created by power dissipation and is usually measured in degree Celsius per watt ($^{\circ}C/W$). The junction temperature, T_J , can be calculated by the rise of the silicon temperature, ΔT , the power dissipation, P_D , and the package thermal resistance, $R_{\theta JA}$, as in Equation (3):

$$P_D = V_{CC} \times I_{CC} + \sum_{x=1}^2 (V_{CC} - V_{LEDx}) \times I_{OUTx} \quad (3)$$

and,

$$T_J = T_A + \Delta T = T_A + P_D \times R_{\theta JA} \quad (4)$$

Where V_{CC} is the supply voltage, V_{LEDx} is the voltage across V_{CC} to $OUTx$ and T_A is the ambient temperature.

When operating the chip at high ambient temperatures, or when driving maximum load current, care must be taken to avoid exceeding the package power dissipation limits. The maximum power dissipation can be calculated using the following Equation (5):

$$P_{D(MAX)} = \frac{125^{\circ}C - 25^{\circ}C}{R_{\theta JA}} \quad (5)$$

So,

$$P_{D(MAX)} = \frac{125^{\circ}C - 25^{\circ}C}{35^{\circ}C/W} \approx 2.86W$$

Figure 21, shows the power derating of the IS32LT3120 on a JEDEC boards (in accordance with JESD 51-5 and JESD 51-7) standing in still air.

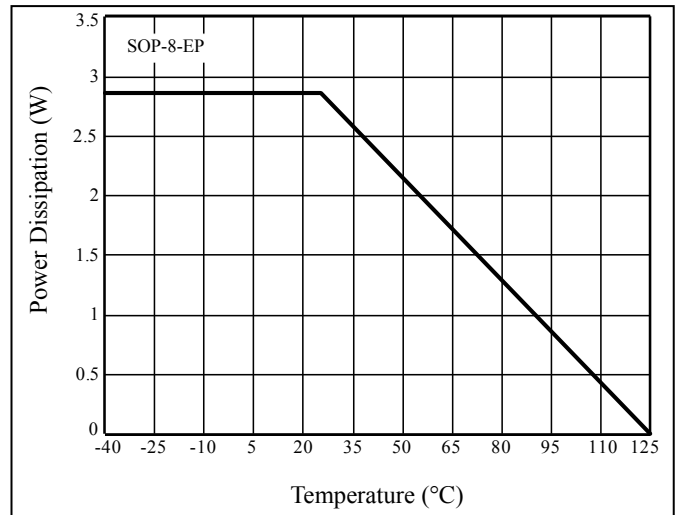

Figure 21 Dissipation Curve

IS32LT3120

CLASSIFICATION REFLOW PROFILES

Profile Feature	Pb-Free Assembly
Preheat & Soak Temperature min (T _{smin}) Temperature max (T _{smax}) Time (T _{smin} to T _{smax}) (t _s)	150°C 200°C 60-120 seconds
Average ramp-up rate (T _{smax} to T _p)	3°C/second max.
Liquidous temperature (T _L) Time at liquidous (t _L)	217°C 60-150 seconds
Peak package body temperature (T _p)*	Max 260°C
Time (t _p)** within 5°C of the specified classification temperature (T _c)	Max 30 seconds
Average ramp-down rate (T _p to T _{smax})	6°C/second max.
Time 25°C to peak temperature	8 minutes max.

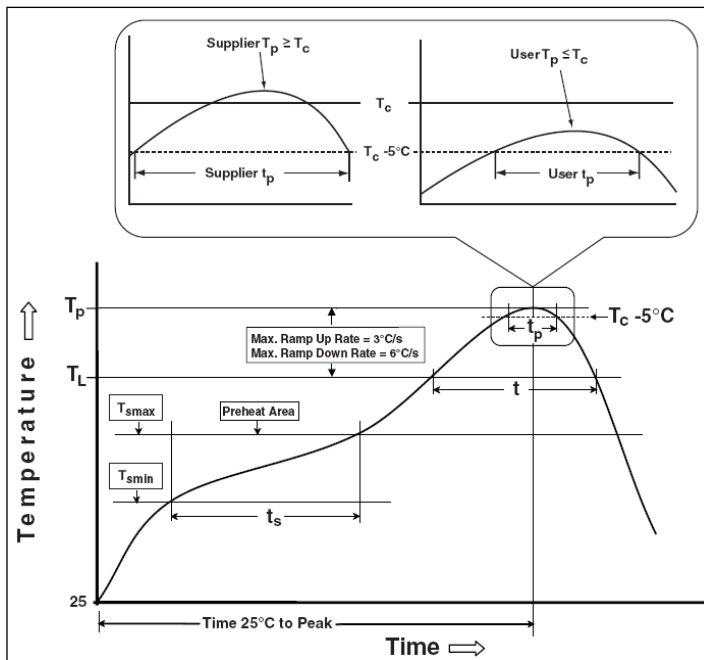

Figure 22 Classification Profile

IS32LT3120

PACKAGE INFORMATION

SOP-8-EP

