

Features

- Schottky barrier diodes
- Low forward voltage drop
- Low leakage current
- Moisture sensitivity: level 1, per J-STD-020
- Solder dip 260 °C, 10 s
- Low profile - typical height of 1.1 mm
- Heatsink design
- High temperature soldering guaranteed: 260°C/10 seconds
- Halogen-free according to IEC 61249-2-21 definition

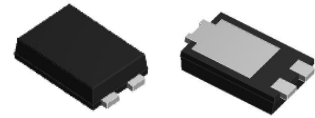

eSGC (TO-277)

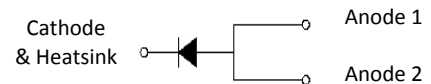

Typical Applications

For low voltage high frequency inverters, DC/DC converters and polarity protection application.

| Maximum Ratings (TA = 25 °C unless otherwise noted) | | | |
|--|---------------------|-------------|------|
| Parameter | Symbol | SGC1045S | Unit |
| Maximum repetitive peak reverse | VRRM | 45 | V |
| Maximum RMS voltage | VRMS | 31.5 | V |
| Maximum DC blocking voltage | VDC | 45 | V |
| Maximum average forward rectified current | IF(AV) ¹ | 10.0 | A |
| | IF(AV) ² | 5.0 | |
| Peak forward surge current 8.3 ms single half sine-wave superimposed on rated load | IFSM | 280 | A |
| Operating junction and storage temperature range | TJ, TSTG | -55 to +150 | °C |

| Electrical Characteristics (TA = 25 °C unless otherwise noted) | | | | | | | |
|--|---------------------|----------|--------|-------|--------|-------|------|
| Parameter | Test Conditions | | Symbol | TYP. | MAX. | Unit | |
| Instantaneous forward voltage | IF=1A | TA=25°C | VF | 0.30 | 0.35 | Volts | |
| | | | | IF=2A | 0.33 | | 0.38 |
| | | | | | IF=10A | | 0.41 |
| | IF=1A | TA=85°C | | 0.22 | 0.27 | | |
| | | | | IF=2A | 0.25 | | 0.3 |
| | | | | | IF=10A | | 0.36 |
| | IF=1A | TA=125°C | | 0.16 | 0.20 | | |
| | | | | IF=2A | 0.20 | | 0.24 |
| | | | | | IF=10A | | 0.32 |
| Instantaneous reverse current | Rated VR | TA=25°C | IR | 0.23 | 0.3 | mA | |
| | | TA=85°C | | 14.5 | 18 | | |
| | | TA=100°C | | 35 | 39 | | |
| Typical junction capacitance | 4.0 V, 1 MHz | | CJ | 0.95 | | nF | |
| Typical thermal resistance ¹⁾ | junction to ambient | | RθJA | 80 | | °C/W | |
| | junction to case | | RθJC | 35 | | | |
| | junction to mount | | RθJM | 20 | | | |

Note:1),The thermal resistance from junction to ambient,case or mount,mounted on P.C.B with 30x30mm copper pads,2 OZ,FR4 PCB

2):Mounted on recommended copper pad area,free air.

Ratings and Characteristics Curves

(TA = 25°C unless otherwise noted)

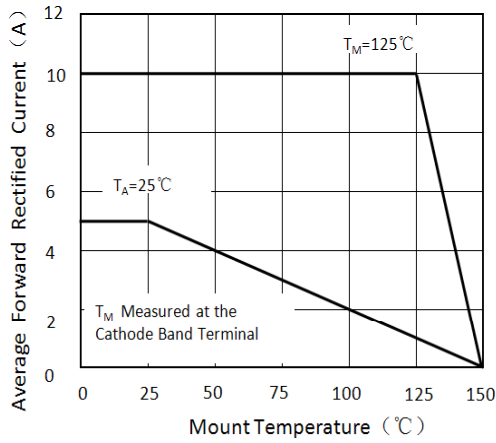

Figure 1. Forward Current Derating Curve

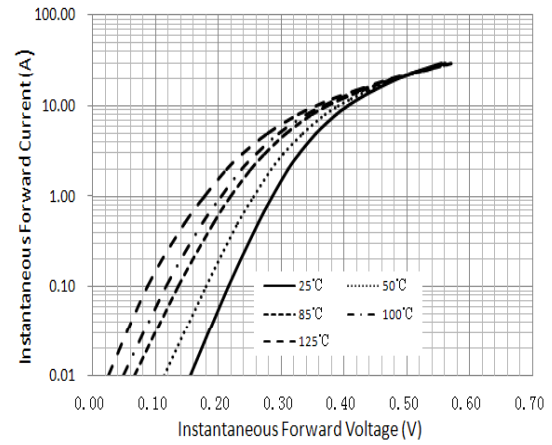

Figure 2. Typical Instantaneous Forward Characteristics

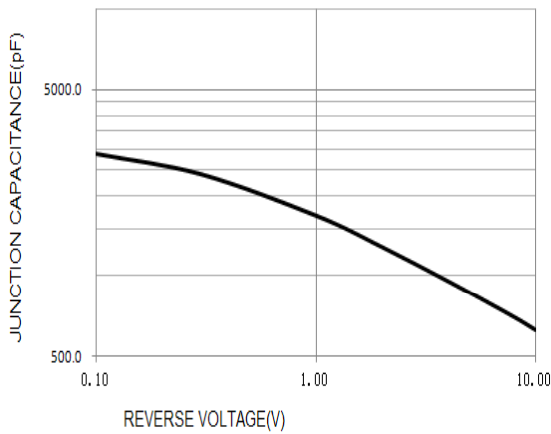

Figure 3. Typical Junction Capacitance

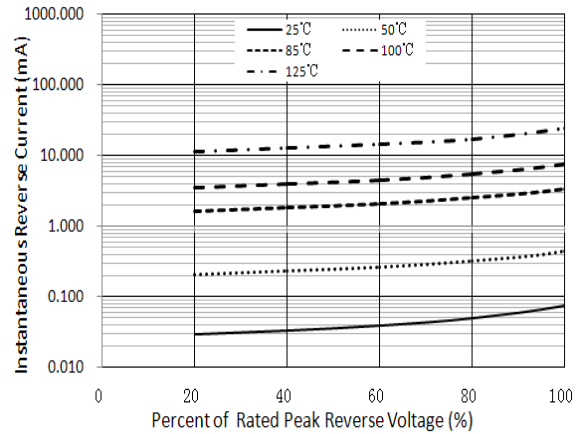

Figure 4. Typical Reverse Characteristics

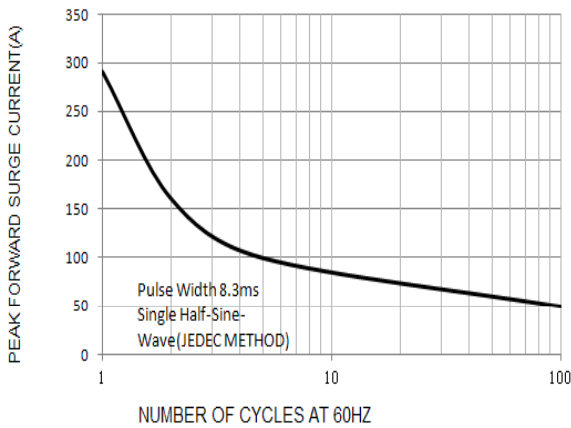
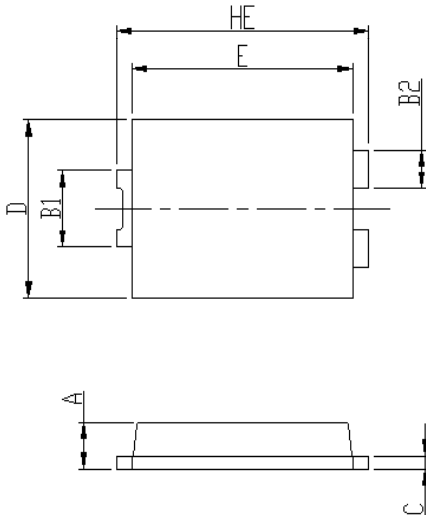

Figure 5. Maximum Non-Repetitive Peak Forward Surge Current

Package Outline Dimensions

in inches (millimeters)



| DIM | Unit: mm | | Unit: inch | |
|-----|-----------|-----|------------|-------|
| | MIN | MAX | MIN | MAX |
| HE | 6.4 | 6.6 | 0.252 | 0.260 |
| E | 5.6 | 5.8 | 0.220 | 0.228 |
| D | 4.1 | 4.3 | 0.161 | 0.169 |
| B1 | 1.7 | 1.9 | 0.067 | 0.075 |
| B2 | 0.8 | 1 | 0.031 | 0.039 |
| A | 1.05 | 1.2 | 0.041 | 0.047 |
| C | 0.3 | 0.4 | 0.012 | 0.016 |
| L | 0.85 | 1.1 | 0.033 | 0.043 |
| L1 | 4.2 | 4.4 | 0.165 | 0.173 |
| L2 | 3.52 Typ. | | 0.139 Typ. | |
| L3 | 1.1 | 1.4 | 0.043 | 0.055 |
| D1 | 3 | 3.3 | 0.118 | 0.130 |
| E1 | 1.86 Typ. | | 0.073 Typ. | |

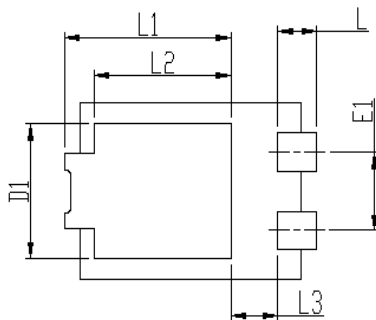

Soldering footprint

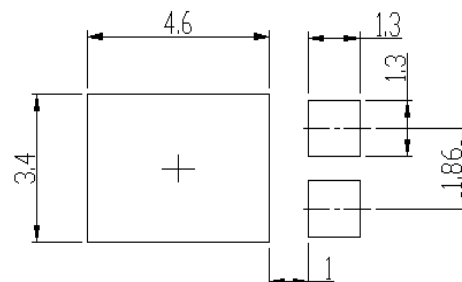

Packing Information

Packing quantities:

5000 pcs/Reel, 12mm Tape, 13" Reel

Tape & Reel Specification

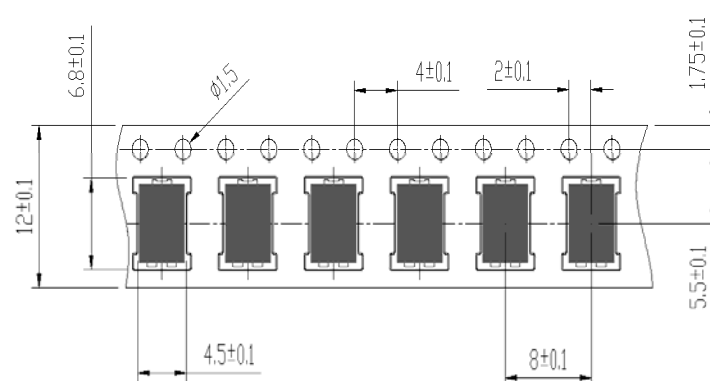



Disclaimers

These materials are intended as a reference to assist our customers in the selection of the Suzhou Good-Ark product best suited to the customer's application; they do not convey any license under any intellectual property rights, or any other rights, belonging to Suzhou Good-Ark Electronics Co., Ltd. or a third party.

Suzhou Good-Ark Electronics Co., Ltd. assumes no responsibility for any damage, or infringement of any third-party's rights, originating in the use of any product data, diagrams, charts, programs, algorithms, or circuit application examples contained in these materials.

All information contained in these materials, including product data, diagrams, charts, programs and algorithms represents information on products at the time of publication of these materials, and are subject to change by Suzhou Good-Ark Electronics Co., Ltd. without notice due to product improvements or other reasons. It is therefore recommended that customers contact Suzhou Good-Ark Electronics Co., Ltd. or an authorized Suzhou Good-Ark Electronics Co., Ltd. for the latest product information before purchasing a product listed herein. The information described here may contain technical inaccuracies or typographical errors. Suzhou Good-Ark Electronics Co., Ltd. assumes no responsibility for any damage, liability, or other loss rising from these inaccuracies or errors. Please also pay attention to information published by Suzhou Good-Ark Electronics Co., Ltd. by various means, including our website home page.
(<http://www.goodark.com>)

When using any or all of the information contained in these materials, including product data, diagrams, charts, programs, and algorithms, Please be sure to evaluate all information as a total system before making a final decision on the applicability of the information and products. Suzhou Good-Ark Electronics Co., Ltd. assumes no responsibility for any damage, liability or other loss resulting from the information contained herein.

The prior written approval of Suzhou Good-Ark Electronics Co., Ltd. is necessary to reprint or reproduce in whole or in part these materials.

Please contact Suzhou Good-Ark Electronics Co., Ltd. or an authorized distributor for further details on these materials or the products contained herein.