



ON Semiconductor®

www.onsemi.com

# NDBA100N10B

## Power MOSFET 100V, 6.9mΩ, 100A, N-Channel

### Features

- Low On-Resistance
- Low Gate Charge
- High Speed Switching
- 100% Avalanche Tested
- Pb-Free, Halogen Free and RoHS Compliance

### Specifications

Absolute Maximum Ratings at Ta = 25°C

Parameter	Symbol	Value	Unit
Drain to Source Voltage	V <sub>DSS</sub>	100	V
Gate to Source Voltage	V <sub>GSS</sub>	±20	V
Drain Current (DC)	I <sub>D</sub>	100	A
Drain Current (Pulse) PW≤10μs, duty cycle≤1%	I <sub>DP</sub>	400	A
Power Dissipation Tc=25°C	P <sub>D</sub>	110	W
Junction Temperature	T <sub>J</sub>	175	°C
Storage Temperature	T <sub>stg</sub>	-55 to +175	°C
Source Current (Body Diode)	I <sub>S</sub>	100	A
Avalanche Energy (Single Pulse) *1	E <sub>AS</sub>	147	mJ
Lead Temperature for Soldering Purposes, 3mm from Case for 10 Seconds	T <sub>L</sub>	260	°C

### Thermal Resistance Ratings

Parameter	Symbol	Value	Unit
Junction to Case Steady State	R <sub>θJC</sub>	1.36	°C/W
Junction to Ambient *2	R <sub>θJA</sub>	62.5	

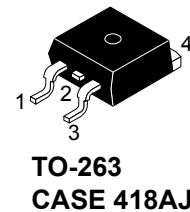
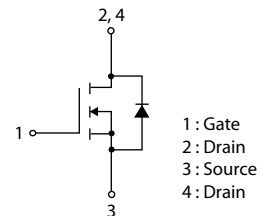
Note : \*1 V<sub>DD</sub>=48V, L=100μH, I<sub>AV</sub>=40A (Fig.1)

\*2 Surface mounted on FR4 board using recommended footprint

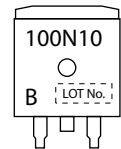
Stresses exceeding those listed in the Maximum Ratings table may damage the device. If any of these limits are exceeded, device functionality should not be assumed, damage may occur and reliability may be affected.

V <sub>DSS</sub>	R <sub>DS(on) Max</sub>	I <sub>D Max</sub>
100V	6.9 mΩ@15V	100A
	8.2 mΩ@10V	

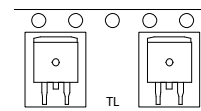
### Electrical Connection N-Channel



### Marking



### Packing Type : TL



### ORDERING INFORMATION

See detailed ordering and shipping information on page 5 of this data sheet.

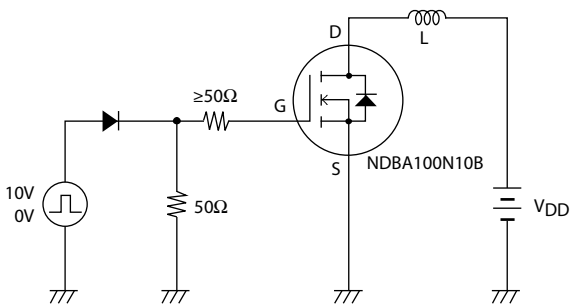
# NDBA100N10B

## Electrical Characteristics at Ta = 25°C

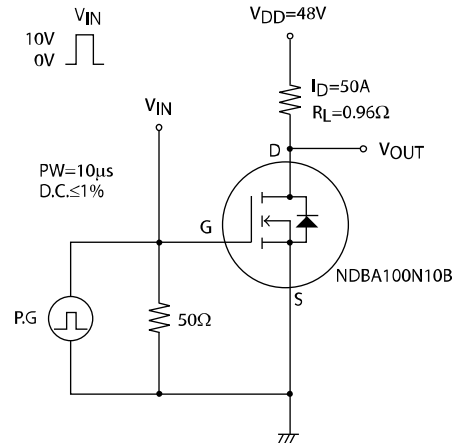
Parameter	Symbol	Conditions	Value			Unit
			min	typ	max	
Drain to Source Breakdown Voltage	$V_{(BR)DSS}$	$I_D=10mA, V_{GS}=0V$	100			V
Zero-Gate Voltage Drain Current	$I_{DSS}$	$V_{DS}=100V, V_{GS}=0V$			10	$\mu A$
Gate to Source Leakage Current	$I_{GSS}$	$V_{GS}=\pm 20V, V_{DS}=0V$			$\pm 100$	nA
Gate Threshold Voltage	$V_{GS(th)}$	$V_{DS}=10V, I_D=1mA$	2		4	V
Forward Transconductance	$g_{FS}$	$V_{DS}=10V, I_D=50A$		75		S
Static Drain to Source On-State Resistance	$R_{DS(on)1}$	$I_D=50A, V_{GS}=15V$		5.7	6.9	$m\Omega$
	$R_{DS(on)2}$	$I_D=50A, V_{GS}=10V$		6.3	8.2	$m\Omega$
Input Capacitance	$C_{iss}$	$V_{DS}=50V, f=1MHz$		2,950		pF
Output Capacitance	$C_{oss}$			1,250		pF
Reverse Transfer Capacitance	$C_{rss}$			20		pF
Turn-ON Delay Time	$t_{d(on)}$			40		ns
Rise Time	$t_r$	See Fig.2		385		ns
Turn-OFF Delay Time	$t_{d(off)}$			68		ns
Fall Time	$t_f$			52		ns
Total Gate Charge	$Q_g$	$V_{DS}=48V, V_{GS}=10V, I_D=100A$		35		nC
Gate to Source Charge	$Q_{gs}$			13		nC
Gate to Drain "Miller" Charge	$Q_{gd}$			10		nC
Forward Diode Voltage	$V_{SD}$	$I_S=100A, V_{GS}=0V$		1.1	1.5	V
Reverse Recovery Time	$t_{rr}$	See Fig.3		130		ns
Reverse Recovery Charge	$Q_{rr}$	$I_S=100A, V_{GS}=0V, V_{DD}=50V, di/dt=100A/\mu s$		400		nC

Product parametric performance is indicated in the Electrical Characteristics for the listed test conditions, unless otherwise noted. Product performance may not be indicated by the Electrical Characteristics if operated under different conditions.

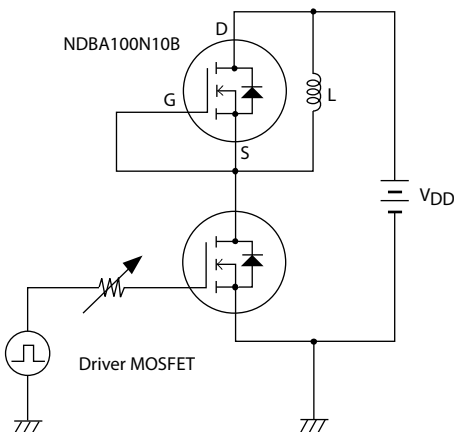
**Fig.1 Unclamped Inductive Switching Test Circuit**

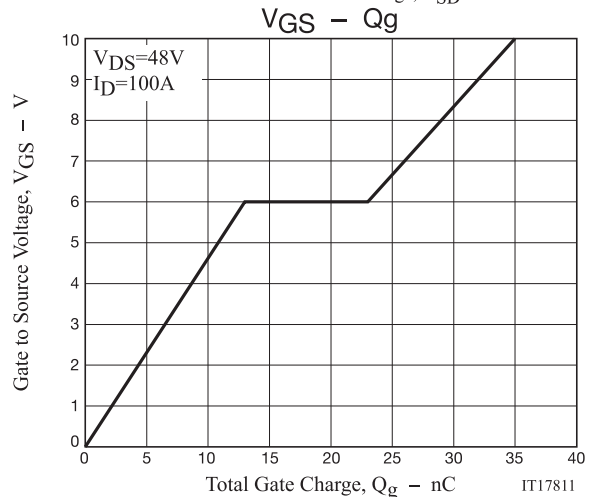
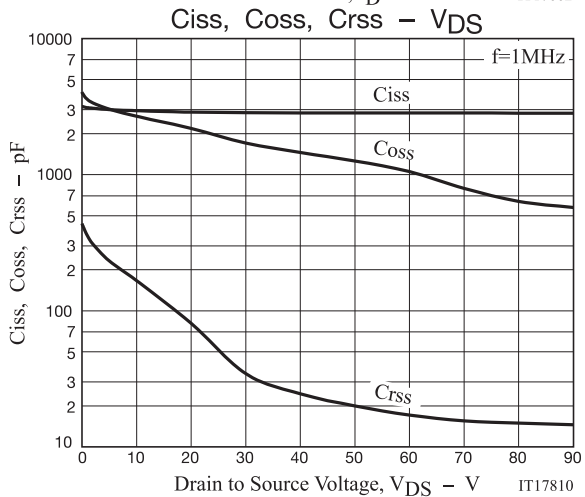
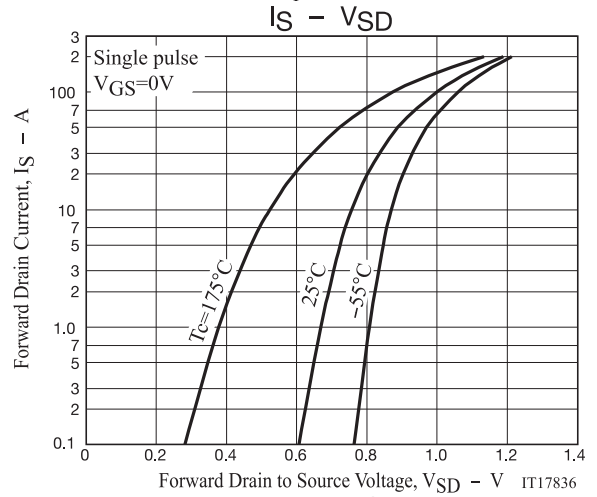
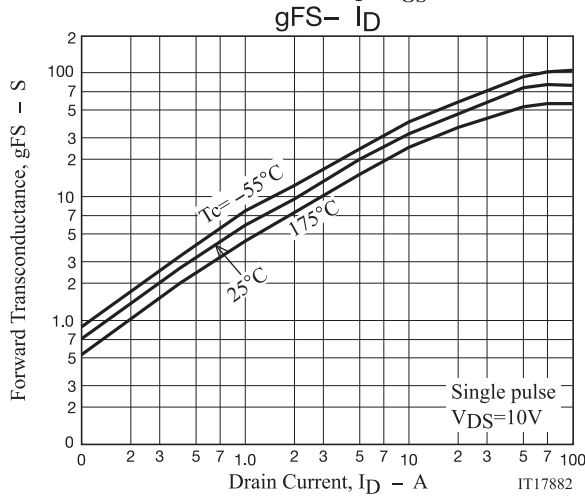
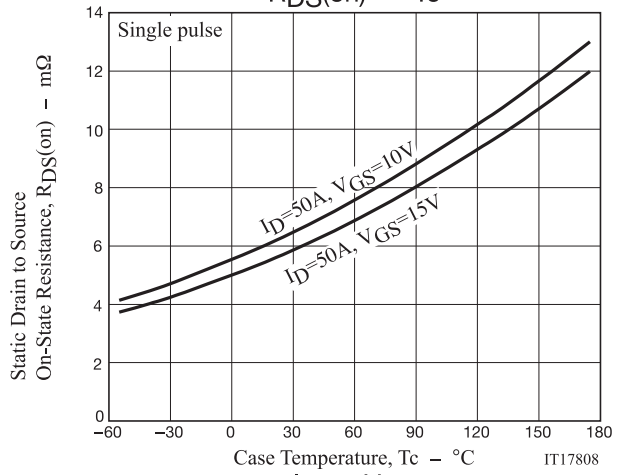
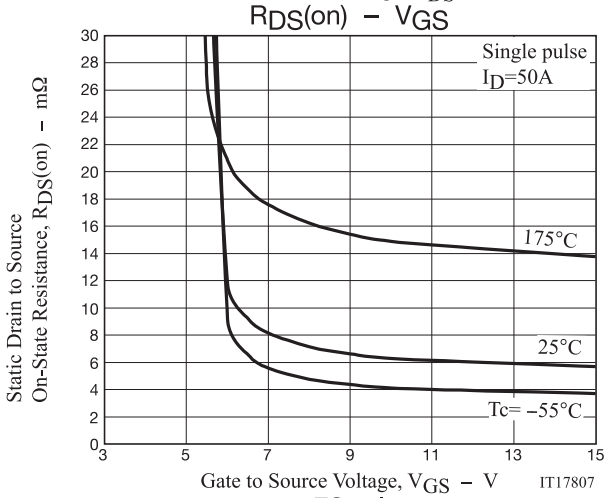
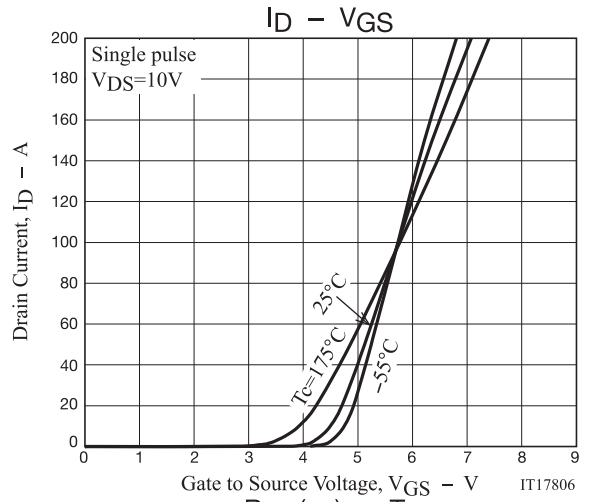
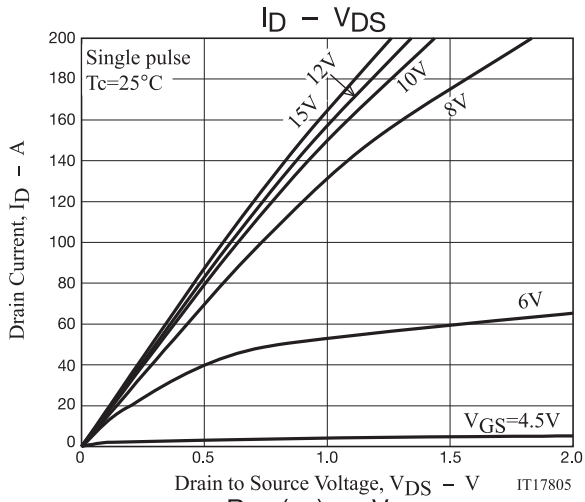


**Fig.2 Switching Time Test Circuit**

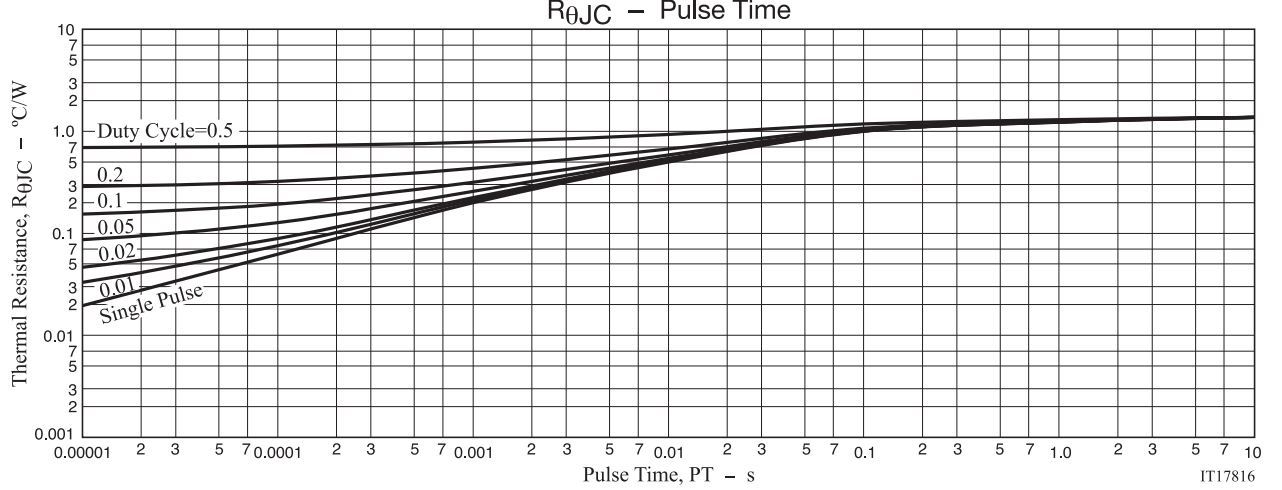
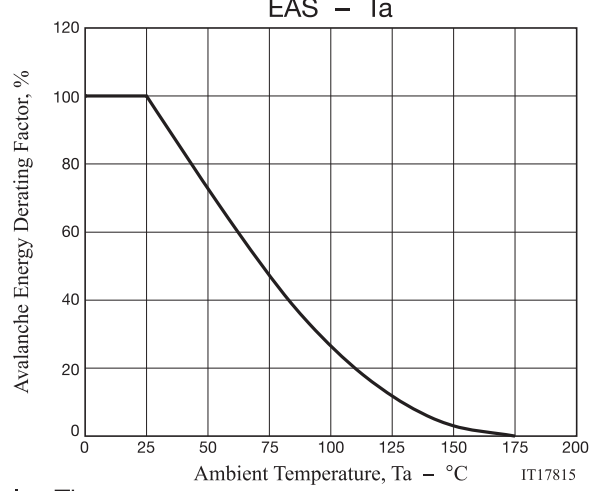
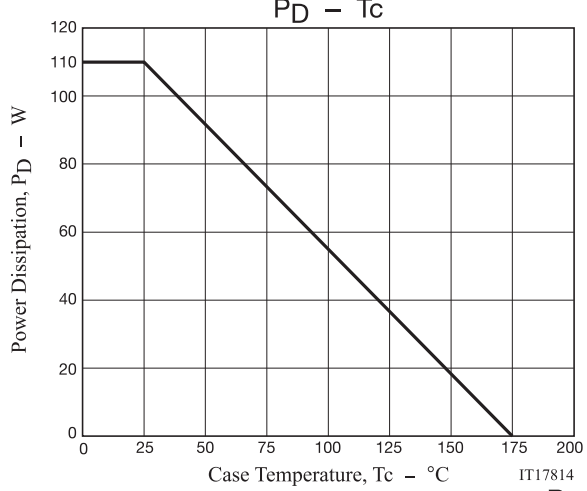
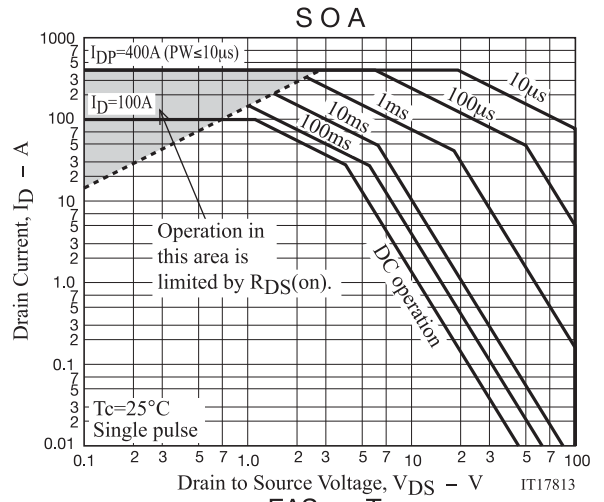
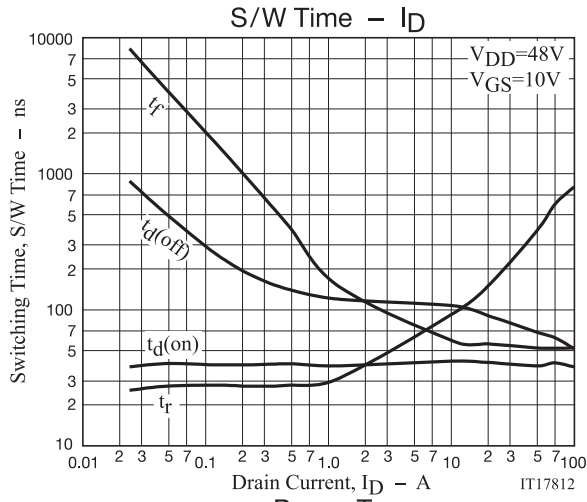


**Fig.3 Reverse Recovery Time Test Circuit**





# NDBA100N10B



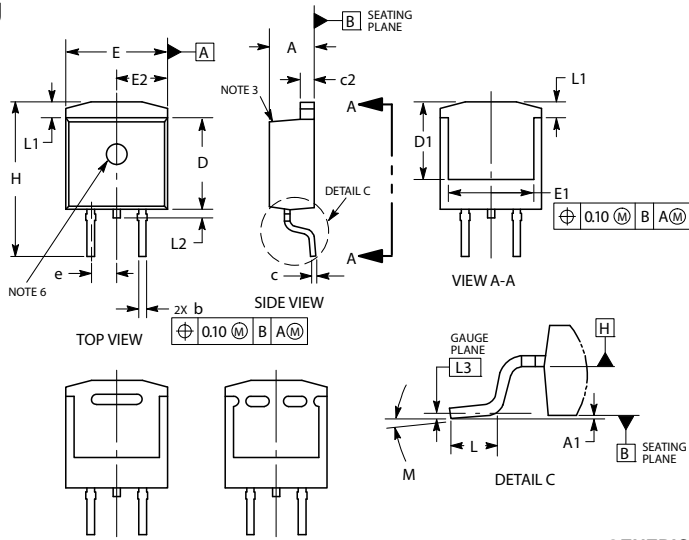
Package Dimensions

NDBA100N10BT4H

D<sup>2</sup>PAK-3 (TO-263, 3-LEAD)

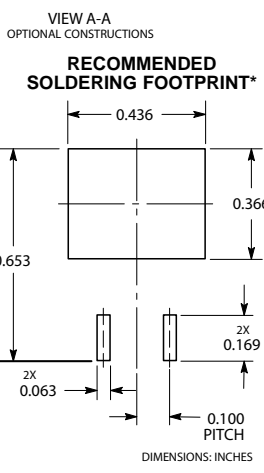
CASE 418AJ

ISSUE B

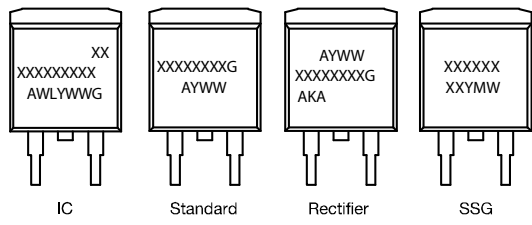


- NOTES:
1. DIMENSIONING AND TOLERANCING PER ASME Y14.5M, 1994.
  2. CONTROLLING DIMENSION: INCHES.
  3. CHAMFER OPTIONAL.
  4. DIMENSIONS D AND E DO NOT INCLUDE MOLD FLASH. MOLD FLASH SHALL NOT EXCEED 0.005 PER SIDE. THESE DIMENSIONS ARE MEASURED AT THE OUTERMOST EXTREMES OF THE PLASTIC BODY AT DATUM H.
  5. THERMAL PAD CONTOUR IS OPTIONAL WITHIN DIMENSIONS E, L1, D1 AND E1.
  6. OPTIONAL MOLD FEATURE

DIM	INCHES		MILLIMETERS	
	MIN	MAX	MIN	MAX
A	0.160	0.190	4.06	4.83
A1	0.000	0.010	0.00	0.25
b	0.020	0.039	0.51	0.99
c	0.012	0.029	0.30	0.74
c2	0.045	0.065	1.14	1.65
D	0.330	0.380	8.38	9.65
D1	0.260	---	6.60	---
E	0.380	0.420	9.65	10.67
E1	0.245	---	6.22	---
e	0.100 BSC		2.54 BSC	
H	0.575	0.625	14.60	15.88
L	0.070	0.110	1.78	2.79
L1	---	0.066	---	1.68
L2	---	0.070	---	1.78
L3	0.010 BSC		0.25 BSC	
M	0°	8°	0°	8°



GENERIC MARKING DIAGRAMS\*



- XXXXXX = Specific Device Code
- A = Assembly Location
- WL = Wafer Lot
- Y = Year
- WW = Work Week
- W = Week Code (SSG)
- M = Month Code (SSG)
- G = Pb-Free Package
- AKA = Polarity Indicator

\*For additional information on our Pb-Free strategy and soldering details, please download the ON Semiconductor Soldering and Mounting Techniques Reference Manual, SOLDERRM/D.

\*This information is generic. Please refer to device data sheet for actual part marking. Pb-Free indicator, "G" or microdot "▪", may or may not be present.

ORDERING INFORMATION

Device	Package	Shipping	note
NDBA100N10BT4H	D <sup>2</sup> PAK-3 (TO-263, 3-LEAD)	800 pcs. / Tape & Reel	Pb-Free and Halogen Free

† For information on tape and reel specifications, including part orientation and tape sizes, please refer to our Tape and Reel Packaging Specifications Brochure, BRD8011/D. [http://www.onsemi.com/pub\\_link/Collateral/BRD8011-D.PDF](http://www.onsemi.com/pub_link/Collateral/BRD8011-D.PDF)

Note on usage : Since the NDBA100N10B is a MOSFET product, please avoid using this device in the vicinity of highly charged objects.

ON Semiconductor and the ON logo are registered trademarks of Semiconductor Components Industries, LLC (SCILLC) or its subsidiaries in the United States and/or other countries. SCILLC owns the rights to a number of patents, trademarks, copyrights, trade secrets, and other intellectual property. A listing of SCILLC's product/patent coverage may be accessed at [www.onsemi.com/site/pdf/Patent-Marking.pdf](http://www.onsemi.com/site/pdf/Patent-Marking.pdf). SCILLC reserves the right to make changes without further notice to any products herein. SCILLC makes no warranty, representation or guarantee regarding the suitability of its products for any particular purpose, nor does SCILLC assume any liability arising out of the application or use of any product or circuit, and specifically disclaims any and all liability, including without limitation special, consequential or incidental damages. "Typical" parameters which may be provided in SCILLC data sheets and/or specifications can and do vary in different applications and actual performance may vary over time. All operating parameters, including "Typicals" must be validated for each customer application by customer's technical experts. SCILLC does not convey any license under its patent rights nor the rights of others. SCILLC products are not designed, intended, or authorized for use as components in systems intended for surgical implant into the body, or other applications intended to support or sustain life, or for any other application in which the failure of the SCILLC product could create a situation where personal injury or death may occur. Should Buyer purchase or use SCILLC products for any such unintended or unauthorized application, Buyer shall indemnify and hold SCILLC and its officers, employees, subsidiaries, affiliates, and distributors harmless against all claims, costs, damages, and expenses, and reasonable attorney fees arising out of, directly or indirectly, any claim of personal injury or death associated with such unintended or unauthorized use, even if such claim alleges that SCILLC was negligent regarding the design or manufacture of the part. SCILLC is an Equal Opportunity/Affirmative Action Employer. This literature is subject to all applicable copyright laws and is not for resale in any manner.