

## TO-92 Plastic-Encapsulate Transistors

### BC635 / BC637 / BC639 TRANSISTOR (NPN)

#### FEATURES

- High current transistors

#### MARKING

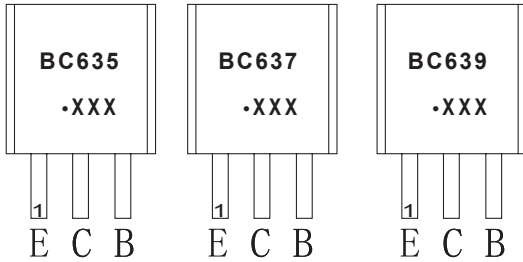

BC635,BC637,BC639=Device code

Solid dot=Green molding compound device,  
if none,the normal device

XXX=Code

#### ORDERING INFORMATION

Part Number	Package	Packing Method	Pack Quantity
BC635	TO-92	Bulk	1000pcs/Bag
BC635-TA	TO-92	Tape	2000pcs/Box
BC637	TO-92	Bulk	1000pcs/Bag
BC637-TA	TO-92	Tape	2000pcs/Box
BC639	TO-92	Bulk	1000pcs/Bag
BC639-TA	TO-92	Tape	2000pcs/Box

#### MAXIMUM RATINGS (T<sub>a</sub>=25°C unless otherwise noted)

Symbol	Parameter	Value	Unit
V <sub>CBO</sub>	Collector-Emitter Voltage	BC635	45
		BC637	60
		BC639	100
V <sub>CEO</sub>	Collector-Emitter Voltage	BC635	45
		BC637	60
		BC639	80
V <sub>EB0</sub>	Emitter-Base Voltage	5	V
I <sub>c</sub>	Collector Current -Continuous	1	A
P <sub>c</sub>	Collector Power Dissipation	0.83	W
T <sub>J</sub>	Junction Temperature	150	°C
T <sub>stg</sub>	Storage Temperature	-65-150	°C

#### TO-92

1. EMITTER
2. COLLECTOR
3. BASE

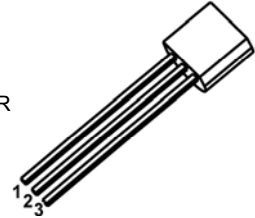

#### Equivalent Circuit

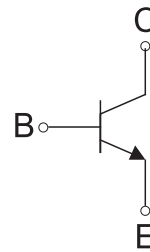

## ELECTRICAL CHARACTERISTICS

$T_a=25^\circ\text{C}$  unless otherwise specified

Parameter	Symbol	Test conditions	Min	Typ	Max	Unit
Collector-emitter breakdown voltage	$V_{(BR)CEO}$	$I_C=10\text{mA}$ , $I_B=0$ BC635	45			V
		BC637	60			V
		BC639	80			V
Collector cut-off current	$I_{CBO}$	$V_{CB}=30\text{V}$ , $I_E=0$			0.1	$\mu\text{A}$
Emitter cut-off current	$I_{EBO}$	$V_{EB}=5\text{V}$ , $I_B=0$			0.1	$\mu\text{A}$
DC current gain	$h_{FE(1)}$	$V_{CE}=2\text{V}$ , $I_C=5\text{mA}$	25			
	$h_{FE(2)}$	$V_{CE}=2\text{V}$ , $I_C=150\text{mA}$ BC635	40		250	
		BC637-10/BC639-10	63		160	
		BC637-16/BC639-16	100		250	
	$h_{FE(3)}$	$V_{CE}=2\text{V}$ , $I_C=500\text{mA}$	25			
Collector-emitter saturation voltage	$V_{CE(sat)}$	$I_C=500\text{mA}$ , $I_B=50\text{mA}$			0.5	V
Base-emitter voltage	$V_{BE}$	$V_{CE}=2\text{V}$ , $I_C=500\text{mA}$			1	V
Transition frequency	$f_T$	$V_{CE}=5\text{V}$ , $I_C=10\text{mA}$ , $f=50\text{MHz}$		100		MHz

# Typical Characteristics

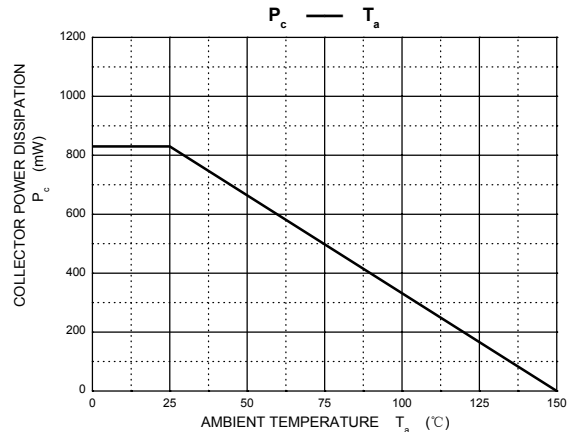
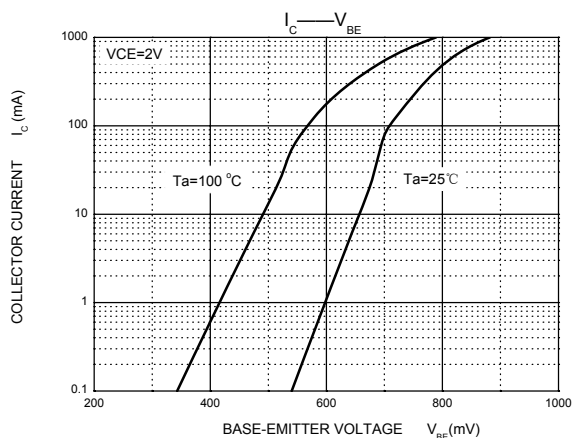
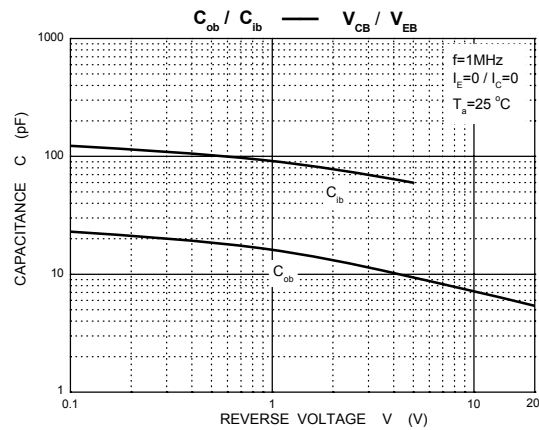
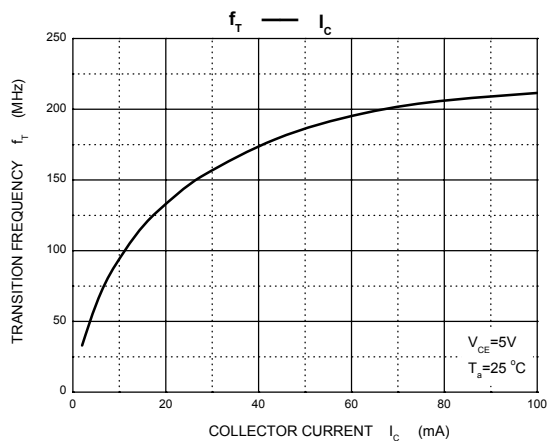
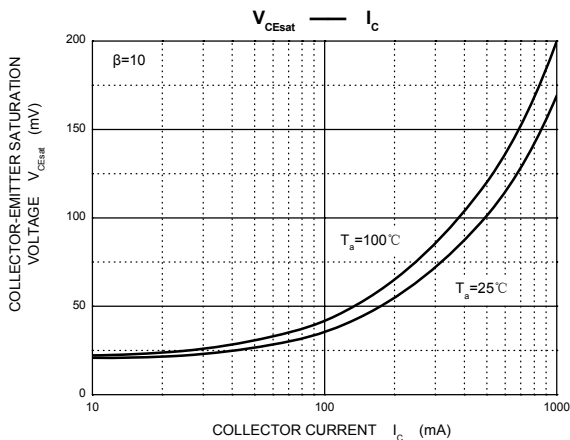
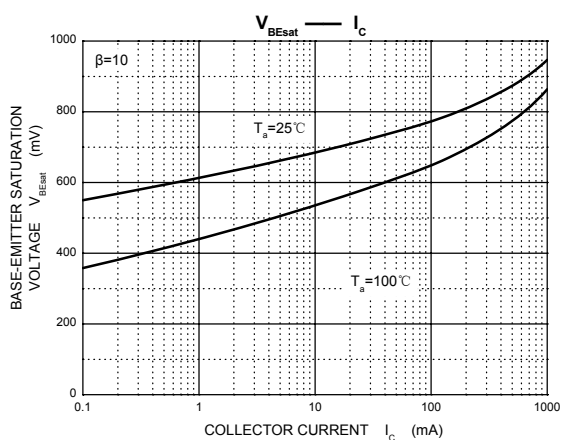
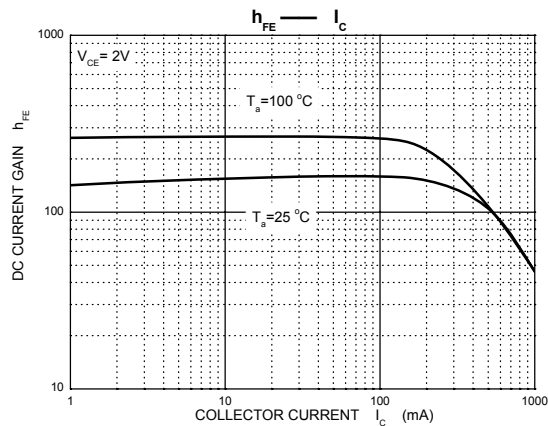
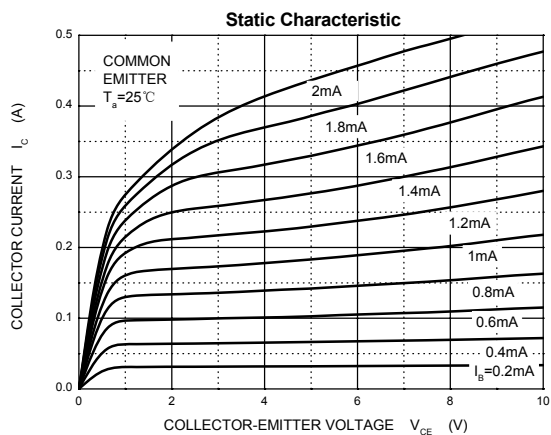

## TO-92 Package Outline Dimensions

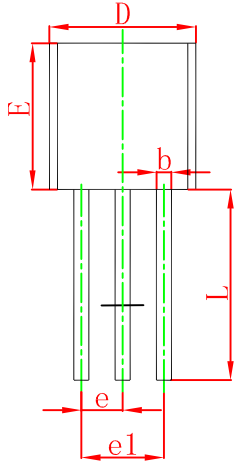
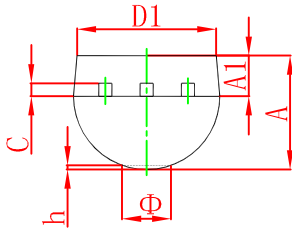

Symbol	Dimensions In Millimeters		Dimensions In Inches	
	Min	Max	Min	Max
A	3.300	3.700	0.130	0.146
A1	1.100	1.400	0.043	0.055
b	0.380	0.550	0.015	0.022
c	0.360	0.510	0.014	0.020
D	4.300	4.700	0.169	0.185
D1	3.430		0.135	
E	4.300	4.700	0.169	0.185
e	1.270 TYP		0.050 TYP	
e1	2.440	2.640	0.096	0.104
L	14.100	14.500	0.555	0.571
Φ		1.600		0.063
h	0.000	0.380	0.000	0.015

## TO-92 Suggested Pad Layout

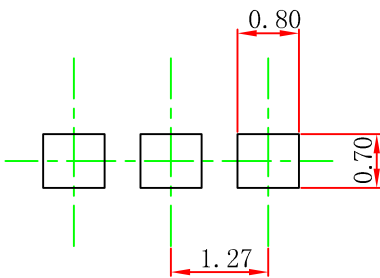

### Note:

1. Controlling dimension: in millimeters.
2. General tolerance:  $\pm 0.05\text{mm}$ .
3. The pad layout is for reference purposes only.

### NOTICE

JCET reserve the right to make modifications, enhancements, improvements, corrections or other changes without further notice to any product herein. JCET does not assume any liability arising out of the application or use of any product described herein.

TO-92 PACKAGE TAPEING DIMENSION

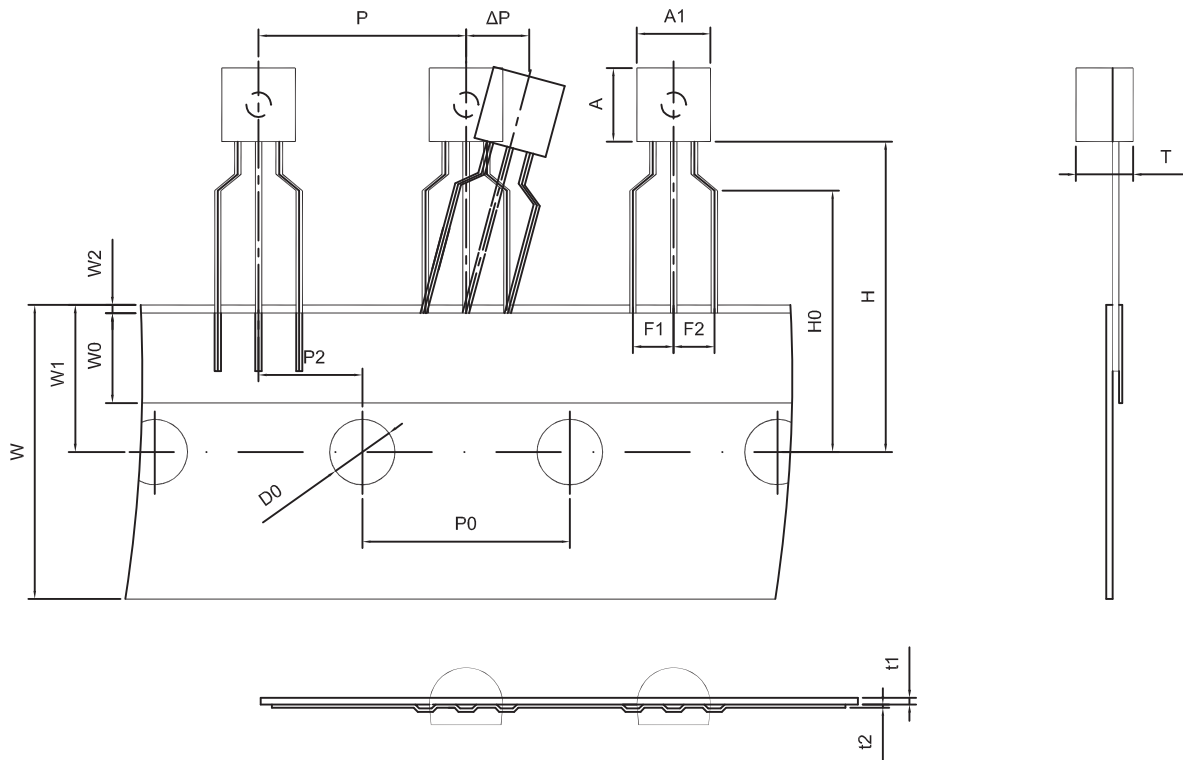

Dimiensions are in millimeter								
A1	A	T	P	P0	P2	F1	F2	W
4.5	4.5	3.5	12.7	12.7	6.35	2.5	2.5	18.0
W0	W1	W2	H	H0	D0	t1	t2	ΔP
6.0	9.0	1.0 MAX.	19.0	16.0	4.0	0.4	0.2	0

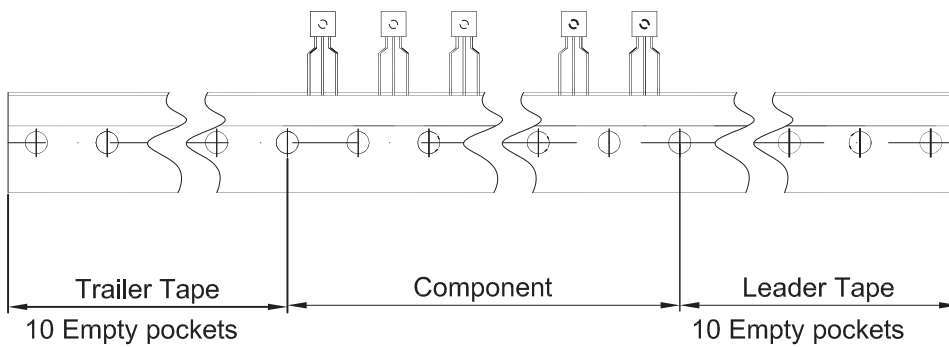

Package	Box	Box Size(mm)	Carton	Carton Size(mm)
TO-92	2000 pcs	333×162×43	20,000 pcs	350×340×250