

## 16-32 Gb, DDR3, 256-512M x 32 Dual Channel Memory Module

### FEATURES

- DDR3 Integrated Module [iMOD]:
  - $V_{DD}=V_{DDQ}=1.35V -0.0675V/+0.1V$
  - 1.35V center-terminated, push/pull I/O
  - Package: 16mm x 22mm x 1.2mm, 13 x 21 matrix w/ 271balls
  - Matrix ball pitch: 1.00mm
- Space saving footprint
- Thermally enhanced, Impedance matched, integrated packaging
- Differential, bi-directional data strobe
- 8n-bit prefetch architecture
- 8 internal banks (per word, 4 words integrated in package)
- Nominal and dynamic on-die termination (ODT) for data, strobe, and mask signals.
- Programmable CAS (READ) latency (CL): 9, 11, and 13
- CAS (WRITE) latency (CWL): 9, 11, and 13
- Fixed burst length (BL) of 8 and burst chop (BC) of 4
- Selectable BC4 or BL8 on-the-fly (OTF)
- Self/Auto Refresh modes
- Operating Temperature Range (ambient temp=TA)
  - Industrial: -40°C to 85°C supporting SELF & AUTO REFRESH
  - Extended: -40°C to 105°C; manual REFRESH only
  - Mil-Temp: -55°C to 125°C; manual REFRESH only
- CORE clocking frequencies: 667, 800, 933 MHz
- Data Transfer Rates: 1333, 1600, 1866 Mbps
- Write leveling
- Multipurpose register
- Output Driver Calibration

### Benefits

- Board area savings with surface mount friendly pitch (1.00mm)
- Reduced interconnect routing
- Reduced trace lengths due to the highly integrated, impedance matched packaging
- Thermally enhanced packaging technology allow silicon integration without performance degradation due to power dissipation (heat)
- High TCE organic laminate interposer for improved glass stability over a wide operating temperature
- Suitability of use in High Reliability applications requiring Mil-temp, non-hermetic device operation

\*Note: This integrated product and/or its specifications are subject to change without notice. Latest document should be retrieved from LDI prior to your design consideration.

### iMOD Part Information

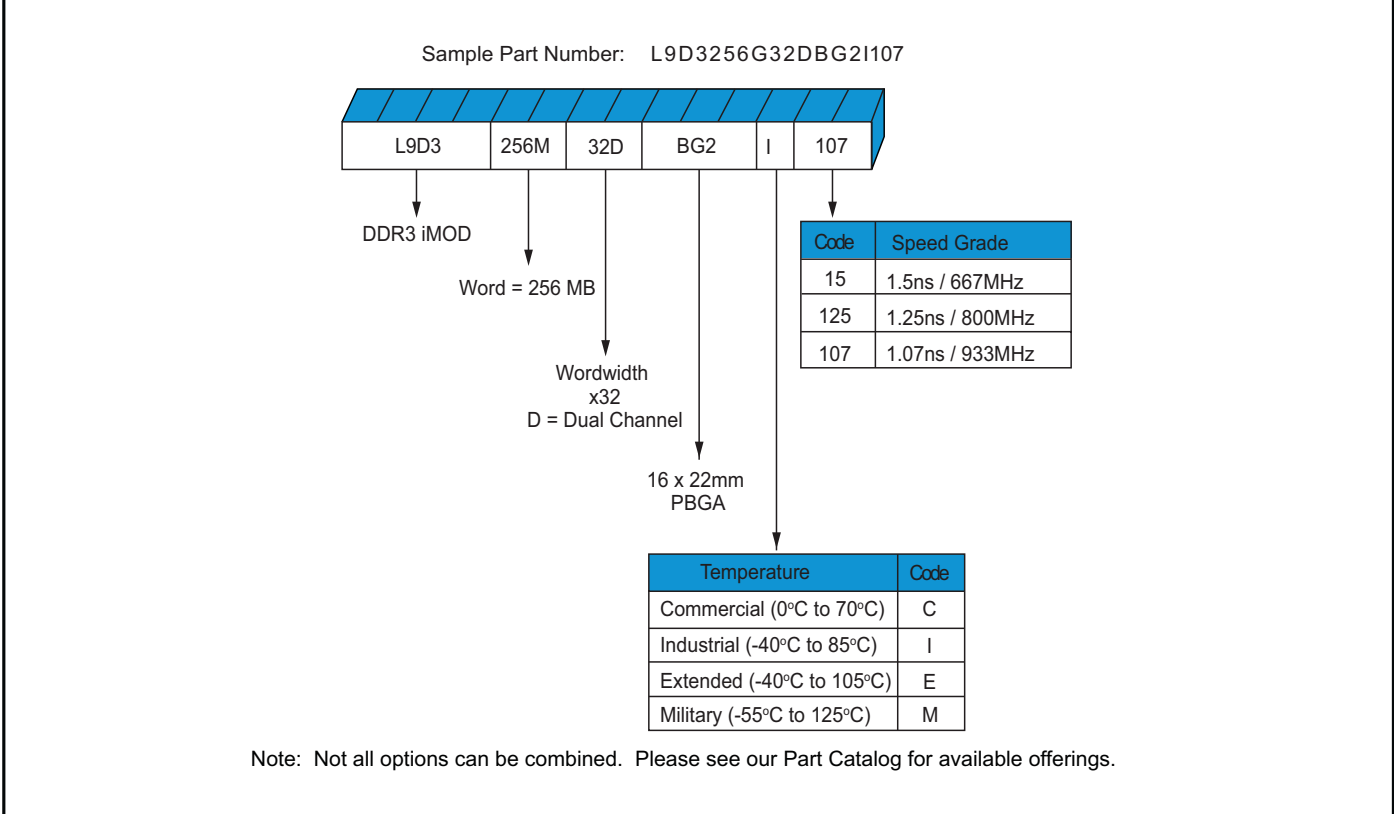
ORDER NUMBER	SPEED GRADE	PKG FOOTPRINT	I/O	PITCH	Pkg No.
L9D3256M32DBG2x107	DDR3-1866	16mm x 22mm	271	1.00mm	BG2
L9D3256M32DBG2x125	DDR3-1600				
L9D3256M32DBG2x15	DDR3-1333				
L9D3512M32DBG2x107	DDR3-1866				
L9D3512M32DBG2x125	DDR3-1600				
L9D3512M32DBG2x15	DDR3-1333				



## 16-32 Gb, DDR3, 256-512M x 32 Dual Channel Memory Module

### FEATURES

**FIGURE 1 - 1Gb DDR3 PART NUMBERS**



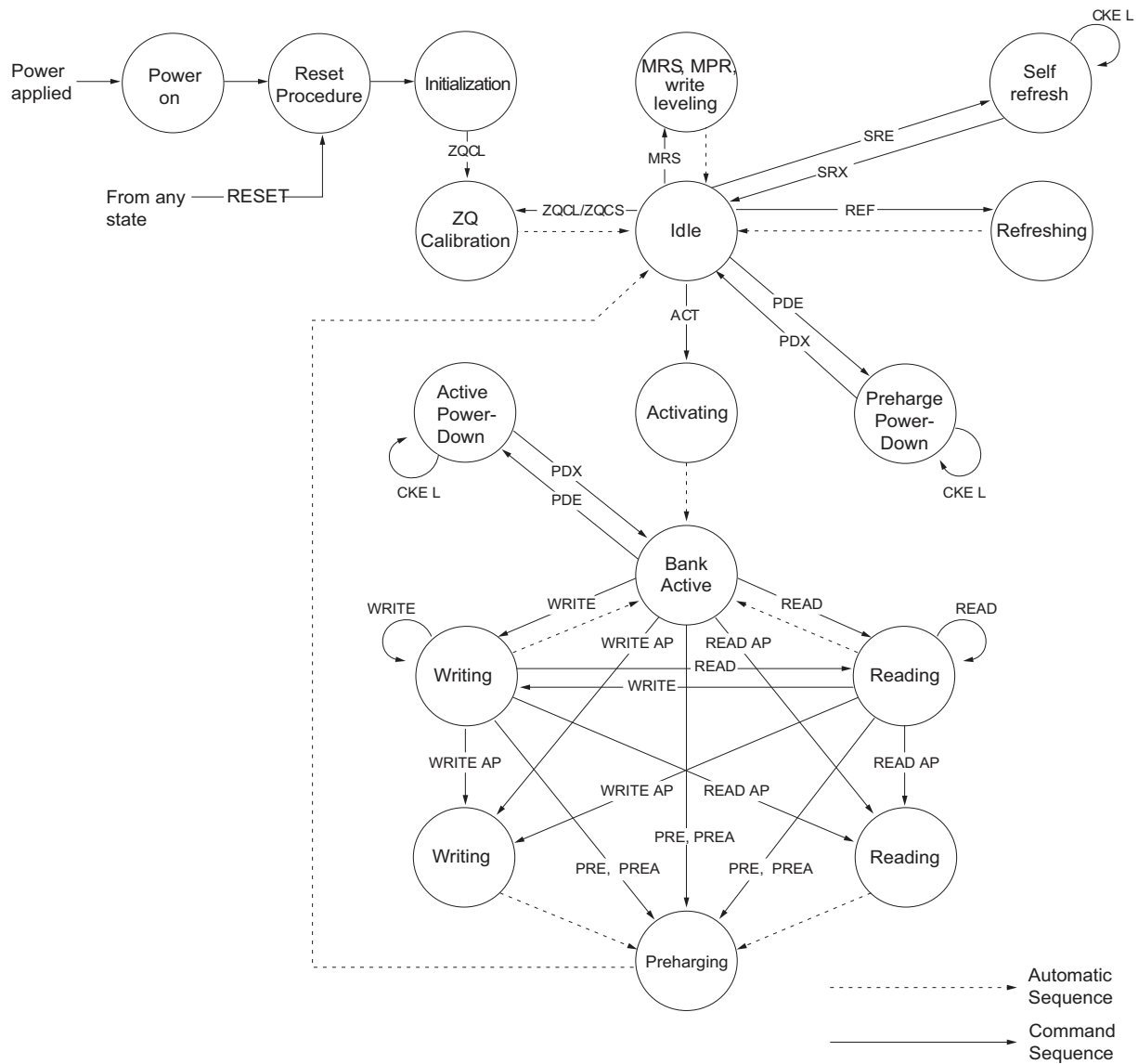
**TABLE 1: ADDRESSING**

Parameter	2 x 256-512 Meg x 32
Configuration	2 x 32 Meg x 8 banks x 32 bits
Refresh Count	8K
ROW Addressing	32K (A[14:0])
Bank Addressing	8 (BA[2:0])
Column Addressing	1K (A[9:0]) / 2K (A[10:0]) 256 M      512M

**16-32 Gb, DDR3, 256-512M x 32 Dual Channel Memory Module**

**STATE DIAGRAM**

**FIGURE 2 - SIMPLIFIED STATE DIAGRAM**



ACT = ACTIVATE  
MPR = Multipurpose register  
MRS = Mode register set  
PDE = Power-down entry  
PDX = Power-down exit  
PRE = PRECHARGE

PREA=PRECHARGE ALL  
READ = RD, RDS4, RDS8  
READ AP = RDAP, RDAPS4, RDAPS8  
REF = REFRESH  
RESET = START RESET PROCEDURE  
SRE = Self refresh entry

SRX = Self refresh exit  
WRITE = WR, WRS4, WRS8  
WRITE AP = WRAP, WRAPS4, WRAPS8  
ZQCL = ZQ LONG CALIBRATION  
ZQCS = ZQ SHORT CALIBRATION

## 16-32 Gb, DDR3, 256-512M x 32 Dual Channel Memory Module

### FUNCTIONAL DESCRIPTION

The DDR3 SDRAM uses double data rate architecture to achieve high speed operation. The double data rate (DDR) architecture is an 8n prefetch with an interface designed to transfer two data words per clock cycle at the I/O pins. A single READ or WRITE access for the DDR3 SDRAM consists of a single 8n-bit-wide, one-clock-cycle data transfer at the internal memory core and eight corresponding n-bit-wide, one-half-clock-cycle data transfer at the I/O pin.

The differential strobes (LDQSx, LDQSx\, UDQSx, UDQSx\) are transmitted externally, along with data, for use in data capture at the DDR3 SDRAM input receiver. DQS is center-aligned with data for WRITES. The READ data is transmitted by the DDR3 SDRAM and edge-aligned to the data strobes.

The DDR3 SDRAM operates from a differential clock (CKx, CKx\). The crossing of CK going HIGH and CK\ going LOW is referred to as the positive edge of Clock (CK). Control, Command, and Address signals are registered at every positive edge of CK. Input data is registered on the first rising edge of DQS after the WRITE preamble, and output data is referenced on the first rising edge of DQS after the READ preamble.

READ and WRITE accesses to the DDR3 SDRAM are burst-oriented. Accesses start at a selected location and continue for a programmed number of locations in a programmed sequence. Accesses begin with the registration of an ACTIVATE command, which is then followed by a READ or WRITE command. The address bits registered coincident with the ACTIVATE command are used to select the bank and the starting column location for the burst access.

DDR3 SDRAM devices use READ and WRITE BL8 and BC4. An AUTO PRECHARGE function may be enabled to provide a self-timed ROW PRECHARGE that is initiated at the end of the burst access.

As with standard DDR SDRAM devices, the pipelined, multi-bank architecture of the DDR3 SDRAM allows for concurrent operation, thereby providing high bandwidth by hiding ROW PRECHARGE and ACTIVATION time.

A SELF REFRESH mode is provided for all temperature grade offerings along with AUTO SELF REFRESH for Industrial product, as well as, power-saving, POWER-DOWN mode.

### INDUSTRIAL TEMPERATURE

The industrial temperature (I) device requires the ambient temperature not exceed  $-40^{\circ}\text{C}$  or  $+85^{\circ}\text{C}$ . JEDEC specifications require the REFRESH rate to double when  $T_A$  exceeds  $+85^{\circ}\text{C}$ ; this also requires use of the high-temperature SELF REFRESH option. Additionally, ODT resistance and the INPUT/OUTPUT impedance must be derated when the  $T_A$  is  $<0^{\circ}\text{C}$  or  $>+85^{\circ}\text{C}$ .

### EXTENDED TEMPERATURE

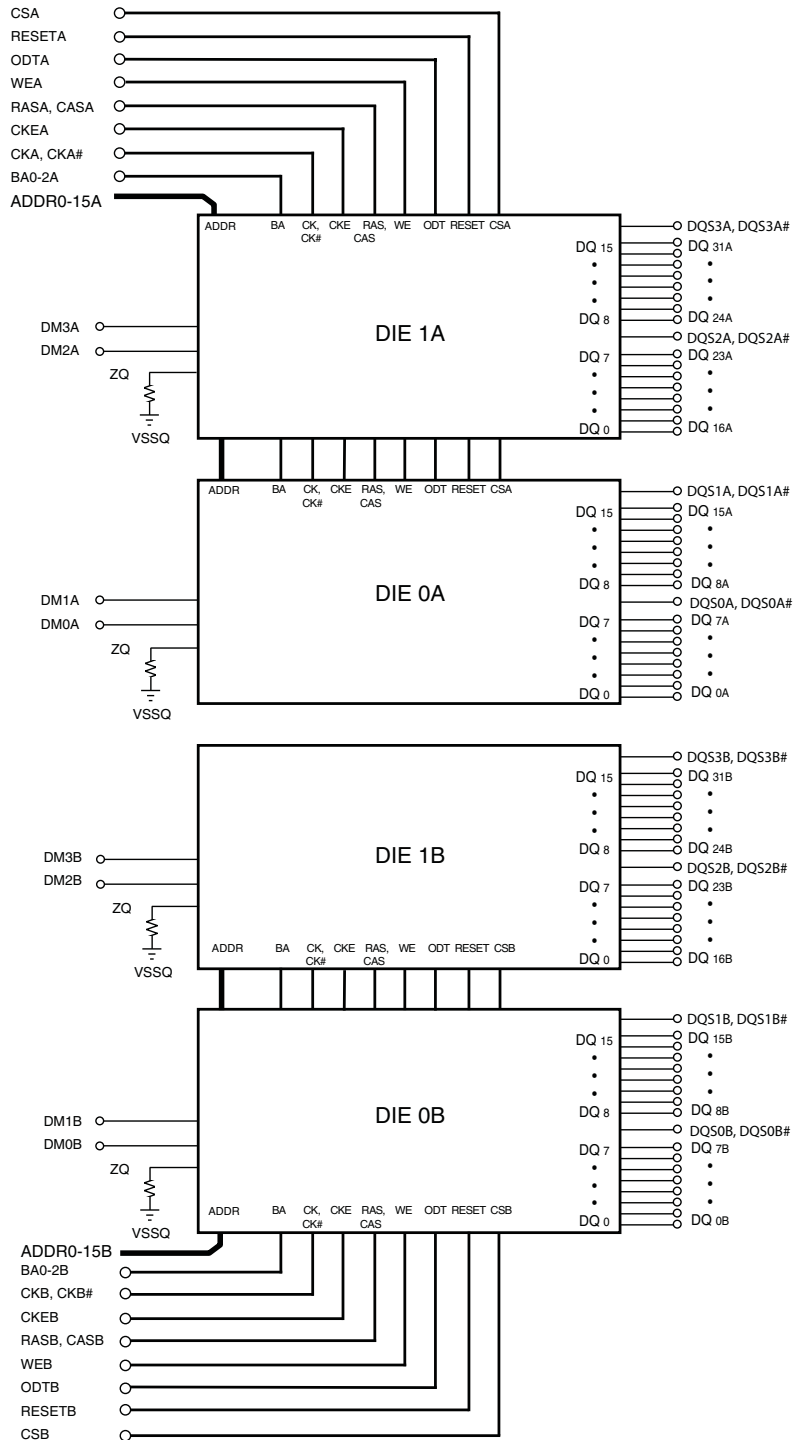
The Extended temperature (E) device requires the ambient temperature not exceed  $-40^{\circ}\text{C}$  or  $+105^{\circ}\text{C}$ . JEDEC specifications require the refresh rate to double when  $T_A$  exceeds  $+85^{\circ}\text{C}$ ; this also requires use of the high-temperature SELF REFRESH option. Additionally, ODT resistance and the INPUT/OUTPUT impedance must be derated when the  $T_A$  is  $<0^{\circ}\text{C}$  or  $>+85^{\circ}\text{C}$ .

### MILITARY, EXTREME OPERATING TEMPERATURE

The Mil-Temp (M) device requires the ambient temperature not exceed  $-55^{\circ}\text{C}$  or  $+125^{\circ}\text{C}$ . JEDEC requires the REFRESH rate double when  $T_A$  exceeds  $+85^{\circ}\text{C}$  and LDI recommends an additional derating as specified in this document as to properly maintain the DRAM core cell charge at temperatures above  $T_A > 105^{\circ}\text{C}$ .

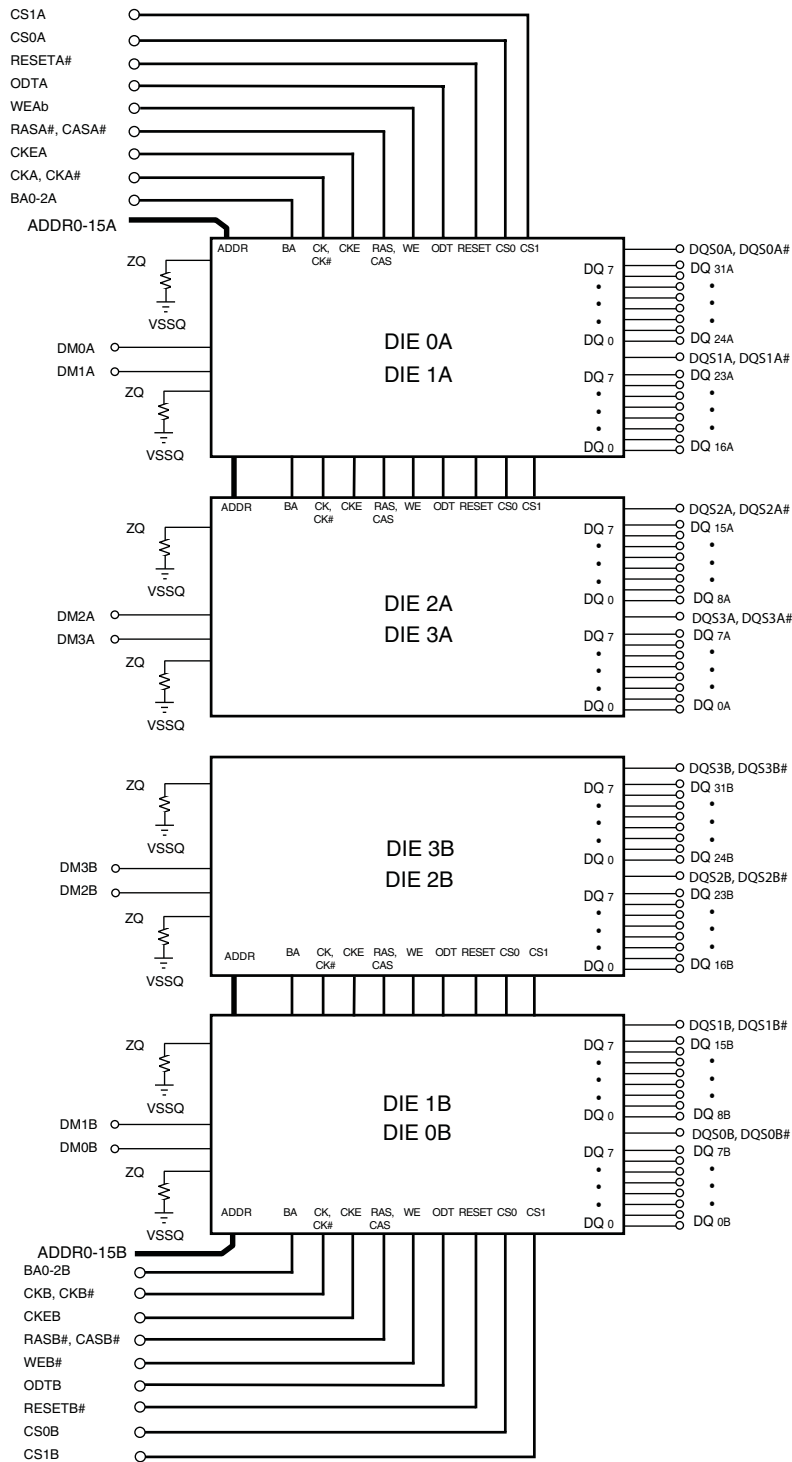
**16-32 Gb, DDR3, 256-512M x 32 Dual Channel Memory Module**

**FIGURE 3A - L9D3256M32DBG2 FUNCTIONAL BLOCK DIAGRAM**



**16-32 Gb, DDR3, 256-512M x 32 Dual Channel Memory Module**

**FIGURE 3B - L9D3512M32DBG2 FUNCTIONAL BLOCK DIAGRAM**














**16-32 Gb, DDR3, 256-512M x 32 Dual Channel Memory Module**

**BALL /SIGNAL LOCATION (PBGA)**

**FIGURE 4 - PINOUT TOP VIEW**

	1	2	3	4	5	6	7	8	9	10	11	12	13	
A	VssQ	VddQ	VssQ	VddQ	VssQ	VddQ	VssQ	Vss	A14A	A13A	A8A	Vdd	Vss	A
B	DQ9A	DQS1A	DQS1A#	DQ13A	DQ15A	DQ14A	DQ12A	Vdd	A9A	A11A	A7A	A6A	A2A	B
C	DQ11A	DQ10A	DQ8A	DQ0A	DQ2A	DQ3A	DQ1A	Vss	RFU	A4A	A5A	A1A	A3A	C
D	VddQ	VssQ	VddQ	VssQ	VddQ	VssQ	VddQ	Vdd	A12A	DM1A	A0A	BA1A	DM0A	D
E	DQ4A	DQ6A	DQ7A	DQ5A	DQS0A#	DQS0A	VssQ	Vdd	RESETA#	BA0A	BA2A	Vss	Vdd	E
F	DQ20A	DQ22A	DQ23A	DQ21A	DQS2A#	DQS2A	VddQ	Vss	CSA1#	VREFCAA	CSA0#	Vdd	Vss	F
G	VssQ	VddQ	VssQ	VddQ	VssQ	VddQ	VssQ	Vdd	RFU	A10A	WEA#	ODTA	CKEA	G
H	DQ26A	DQ24A	DQ16A	DQ18A	DQ19A	DQ17A	Vdd	Vss	VREFDQA	Vss	CASA#	CLKA	Vdd	H
J	DQ27A	DQ25A	DQS3A	DQS3A#	DQ29A	DQ31A	Vss	Vdd	VDDLLA	Vdd	RASA#	CLKA#	Vss	J
K	VddQ	VssQ	VddQ	VssQ	VddQ	VssQ	VddQ	Vss	VSSDLA	Vss	Vdd	DM2A	DM3A	K
L	DQ28A	DQ30A	DQ28B	DQ30B	Vss	Vdd	Vss	Vdd	Vss	Vdd	Vss	Vdd	Vss	L
M	VssQ	VddQ	VssQ	VddQ	VssQ	VddQ	VssQ	Vss	VSSDLLB	Vss	Vdd	DM2B	DM3B	M
N	DQ27B	DQ25B	DQS3B	DQS3B#	DQ29B	DQ31B	Vss	Vdd	VDDLLB	Vdd	RASB#	CLKB#	Vss	N
P	DQ26B	DQ24B	DQ16B	DQ18B	DQ19B	DQ17B	Vdd	Vss	VREFDQB	Vss	CASB#	CLKB	Vdd	P
R	VddQ	VssQ	VddQ	VssQ	VddQ	VssQ	VddQ	Vdd	RFU	A10B	WEB#	ODTB	CKEB	R
T	DQ20B	DQ22B	DQ23B	DQ21B	DQS2B#	DQS2B	VssQ	Vss	CSB1#	VREFCAB	CSB0#	Vdd	Vss	T
U	DQ4B	DQ6B	DQ7B	DQ5B	DQS0B#	DQS0B	VddQ	Vdd	RESETB#	BA0B	BA2B	Vss	Vdd	U
V	VssQ	VddQ	VssQ	VddQ	VssQ	VddQ	VssQ	Vdd	A12B	DM1B	A0B	BA1B	DM0B	V
W	DQ11B	DQ10B	DQ8B	DQ0B	DQ2B	DQ3B	DQ1B	Vss	RFU	A4B	A5B	A1B	A3B	W
Y	DQ9B	DQS1B	DQS1B#	DQ13B	DQ15B	DQ14B	DQ12B	Vdd	A9B	A11B	A7B	A6B	A2B	Y
AA	VddQ	VssQ	VddQ	VssQ	VddQ	VssQ	VddQ	Vss	A14B	A13B	A8B	Vdd	Vss	AA

	GND (Core)		V + (Core Power)		Data IO		Address
	GND (I/O)		V + (I/O Power)		Level REF		RFU
	VSSDLL		VDDLL		CNTRL		

271BGA-1.00MM PITCH - X64, SCB

## 16-32 Gb, DDR3, 256-512M x 32 Dual Channel Memory Module

TABLE 2 - BALL/SIGNAL LOCATION AND DESCRIPTION			
Ball Assignments	Symbol	Type	Description
A9, A10, A11, B9, B10, B11, B12, B13, C9, C10, C11, C12, C13, D9, D11, G10	A0A, A1A, A2A, A3A, A4A, A5A, A6A, A7A, A8A, A9A, A10A /AP, A11A, A12A /BC, A13A, A14A, A15A	Input	<b>Address Inputs:</b> Provide the ROW address for ACTIVATE commands, and the column address and auto precharge bit (A <sub>10</sub> ) for READY/WRITE commands, to select one location out of the memory array in the respective bank. A <sub>10</sub> sampled during a PRECHARGE command determines whether the PRECHARGE applies to one bank (A <sub>10</sub> LOW), bank selected by BA[2:0] or all banks (A <sub>10</sub> HIGH). The address inputs also provide the op-code during a LOAD MODE command. Address inputs are referenced to VrefCA. A <sub>12</sub> /BC#: when enabled in the mode register (MR), A <sub>12</sub> is sampled during READ and WRITE commands to determine whether burst chop, LOW = BC4 burst chop).
D12, E10, E11	BA0A, BA1A, BA2A	Input	<b>Bank Address Inputs:</b> BA[2:0] define the bank to which an ACTIVATE, READ, WRITE, or PRECHARGE command is being applied. BA[2:0] define which mode register (MR <sub>0</sub> , MR <sub>1</sub> , MR <sub>2</sub> , or MR <sub>3</sub> ) is loaded during the LOAD MODE command. BA[2:0] are referenced to VrefCA.
H12, J12	CLKAx, CLKAx#	Input	<b>Clock:</b> CLKx and CLKx# are differential clock inputs, one differential pair per WORD, four WORDS contained in the L9D3xxG64 product. All control and address input signals are sampled on the crossing of the positive edge of CLKx and the negative edge of CLKx#. Output data strobes (DQSx/DQSx#) is referenced to the crossing of CLKx and CLKx#.
G13	CKEA	Input	<b>Clock Enable:</b> CKE enables and disables internal circuitry and clocks on the SDRAM. The specific circuitry that is enabled/disabled is dependent upon the DDR3 SDRAM configuration and operating mode. Taking CKE LOW provides PRECHARGE power-down and SELF REFRESH operations (all banks idle), or active power-down (row active in any bank). CKE is synchronous for power-down entry and exit and for self refresh entry. CKE is asynchronous for self refresh exit. Input buffers (excluding CLKx, CLKx#, CKE, RESET#, and ODT) are disabled during SELF REFRESH. CKE is referenced to VrefCA.
F11	CSA#	Input	<b>Chip Select:</b> CS# enables (registered LOW) and disables the command decoder. All commands are masked when CS# is registered HIGH. CS# provides for external rank selection on systems with multiple ranks. CS# is considered part of the command code. CS# is referenced to VrefCA.
D10, D13, K12, K13,	DMxA	Input	<b>Input Data Mask:</b> DMx is the byte wide data mask for the respective 8-bit data fields. The data mask input, masks WRITE data. Byte data is masked when DMx is sampled HIGH. DMx pins are structured as inputs only, the pins electrical loading is designed to match that of the DQ, DQSx, DQSx# pins.
J11	RASA#	Input	<b>ROW Address Strobe/Select:</b> Defines the command being entered along CAS#, WE#, and CS#. This input pin is referenced to VrefCA.
H11	CASA#	Input	<b>COLUMN Address Strobe/Select:</b> Defines the command being entered along with RAS#, WE#, and CS#. This input pin is referenced to VrefCA.
G11	WEA#	Input	<b>WRITE Enable Input:</b> Defines the command being entered along with CAS#, RAS#, and CS#. This input pin is referenced to VrefCA.



## 16-32 Gb, DDR3, 256-512M x 32 Dual Channel Memory Module

**TABLE 2 - BALL/SIGNAL LOCATION AND DESCRIPTION CONTINUED**

Ball Assignments	Symbol	Type	Description
G12	ODTA	Input	<b>On-Die Termination:</b> ODT enables (when registered HIGH) and disables termination resistance internal to the DDR3 SDRAM. When enabled in normal operation, ODT is only applied to each of the following signals: DQ[63:0], DQSx#, and DMx. The ODT input is ignored if disabled via the LOAD MODE register command. ODT is referenced to VrefCA.
E9	RESETA#	Input	<b>RESET:</b> An input control pin, active LOW referenced to Vss. The RESET# input receiver is a CMOS input defined as a rail to rail signal with DC HIGH $\geq 0.8 \times V_{DD}$ and DC LOW $\leq 0.2 \times V_{DDQ}$ . RESET# assertion and de-assertion are asynchronous.
E5, E6, F5, F6 B2, B3, J3, J4	DQSxA, DQSxA#	Input	<b>Data Strobe Byte (per WORD):</b> Output, edge-aligned with READ data. Input, center-aligned with WRITE data.
C4, C5, C6, C7, E1, E2, E3, E4	DQ0A, DQ1A, DQ2A, DQ3A, DQ4A, DQ5A, DQ6A, DQ7A	I/O	<b>Data Input/Output:</b> LOW Byte, LOW WORD (WORD 1). Pin referenced to VrefDQ.
B1, B4, B5, B6, B7, C1, C2, C3	DQ8A, DQ9A, DQ10A, DQ11A, DQ12A, DQ13A, DQ14A, DQ15A	I/O	<b>Data Input/Output:</b> HIGH Byte, LOW WORD (WORD 1). Pin referenced to VrefDQ.
F1, F2, F3, F4, H3, H4, H5, H6	DQ16A, DQ17A, DQ18A, DQ19A, DQ20A, DQ21A, DQ22A, DQ23A	I/O	<b>Data Input/Output:</b> LOW Byte, WORD 2. Pin referenced to VrefDQ.
H1, H2, J1, J2, J5, J6, L1, L2	DQ24A, DQ25A, DQ26A, DQ27A, DQ28A, DQ29A, DQ30A, DQ31A	I/O	<b>Data Input/Output:</b> HIGH Byte, WORD 2. Pin referenced to VrefDQ.
K9	VSSDLLA		Ground for DLL
J9	VDDDLLA		Supply for DLL
F10	VrefCAA	Supply	Voltage Reference CORE: VrefCA must be maintained at all times
H9	VrefDAA	Supply	Voltage Reference I/O: VrefDQ must be maintained at all times.

## 16-32 Gb, DDR3, 256-512M x 32 Dual Channel Memory Module

TABLE 2 - BALL/SIGNAL LOCATION AND DESCRIPTION CONTINUED				
Ball Assignments	Symbol	Type	Description	L
R10, V9, V11, W9, W10, W11, W12, W13, Y9, Y10, Y11, Y12, Y13, AA9, AA10, AA11	A0B, A1B, A2B, A3B, A4B, A5B, A6B, A7B, A8B, A9B, A10B/AP, A11B, A12B/BC, A13B, A14B, A15B	Input	<b>Address Inputs:</b> Provide the ROW address for ACTIVATE commands, and the column address and auto precharge bit (A10) for READY/WRITE commands, to select one location out of the memory array in the respective bank. A10 sampled during a PRECHARGE command determines whether the PRECHARGE applies to one bank (A10 LOW), bank selected by BA[2:0] or all banks (A10 HIGH). The address inputs also provide the op-code during a LOAD MODE command. Address inputs are referenced to VrefCA. A12/BC#: when enabled in the mode register (MR), A12 is sampled during READ and WRITE commands to determine whether burst chop, LOW = BC4 burst chop.	
U10, U11, V12	BA0B, BA1B, BA2B	Input	<b>Bank Address Inputs:</b> BA[2:0] define the bank to which an ACTIVATE, READ, WRITE, or PRECHARGE command is being applied. BA[2:0] define which mode register (MR0, MR1, MR2, or MR3) is loaded during the LOAD MODE command. BA[2:0] are referenced to VrefCA.	
N12, P12	CLKBx, CLKBx#	Input	<b>Clock:</b> CLKx and CLKBx# are differential clock inputs, one differential pair per WORD, four WORDs contained in the L9D3xxG64 product. All control and address input signals are sampled on the crossing of the positive edge of CLKx and the negative edge of CLKBx#. Output data strobes (DQSx/DQSx#) is referenced to the crossing of CLKx and CLKBx#.	
R13	CKEB	Input	<b>Clock Enable:</b> CKE enables and disables internal circuitry and clocks on the SDRAM. The specific circuitry that is enabled/disabled is dependent upon the DDR3 SDRAM configuration and operating mode. Taking CKE LOW provides PRECHARGE power-down and SELF REFRESH operations (all banks idle), or active power-down (row active in any bank). CKE is synchronous for power-down entry and exit and for self refresh entry. CKE is asynchronous for self refresh exit. Input buffers (excluding CLKx, CLKBx#, CKE, RESET#, and ODT) are disabled during SELF REFRESH. CKE is referenced to VrefCA.	
T11	CSB#	Input	<b>Chip Select:</b> CS# enables (registered LOW) and disables the command decoder. All commands are masked when CS# is registered HIGH. CS# provides for external rank selection on systems with multiple ranks. CS# is considered part of the command code. CS# is referenced to VrefCA.	
M12, M13, V10, V13	DMxB,	Input	<b>Input Data Mask:</b> DMx is the byte wide data mask for the respective 8-bit data fields. The data mask input, masks WRITE data. Byte data is masked when DMx is sampled HIGH. DMx pins are structured as inputs only, the pins electrical loading is designed to match that of the DQ, DQSx, DQSx# pins.	
N11	RASB#	Input	<b>ROW Address Strobe/Select:</b> Defines the command being entered along CAS#, WE#, and CS#. This input pin is referenced to VrefCA.	
P11	CASB#	Input	<b>COLUMN Address Strobe/Select:</b> Defines the command being entered along with RAS#, WE#, and CS#. This input pin is referenced to VrefCA.	
R11	WEB#	Input	<b>WRITE Enable Input:</b> Defines the command being entered along with CAS#, RAS#, and CS#. This input pin is referenced to VrefCA.	

**16-32 Gb, DDR3, 256-512M x 32 Dual Channel Memory Module**

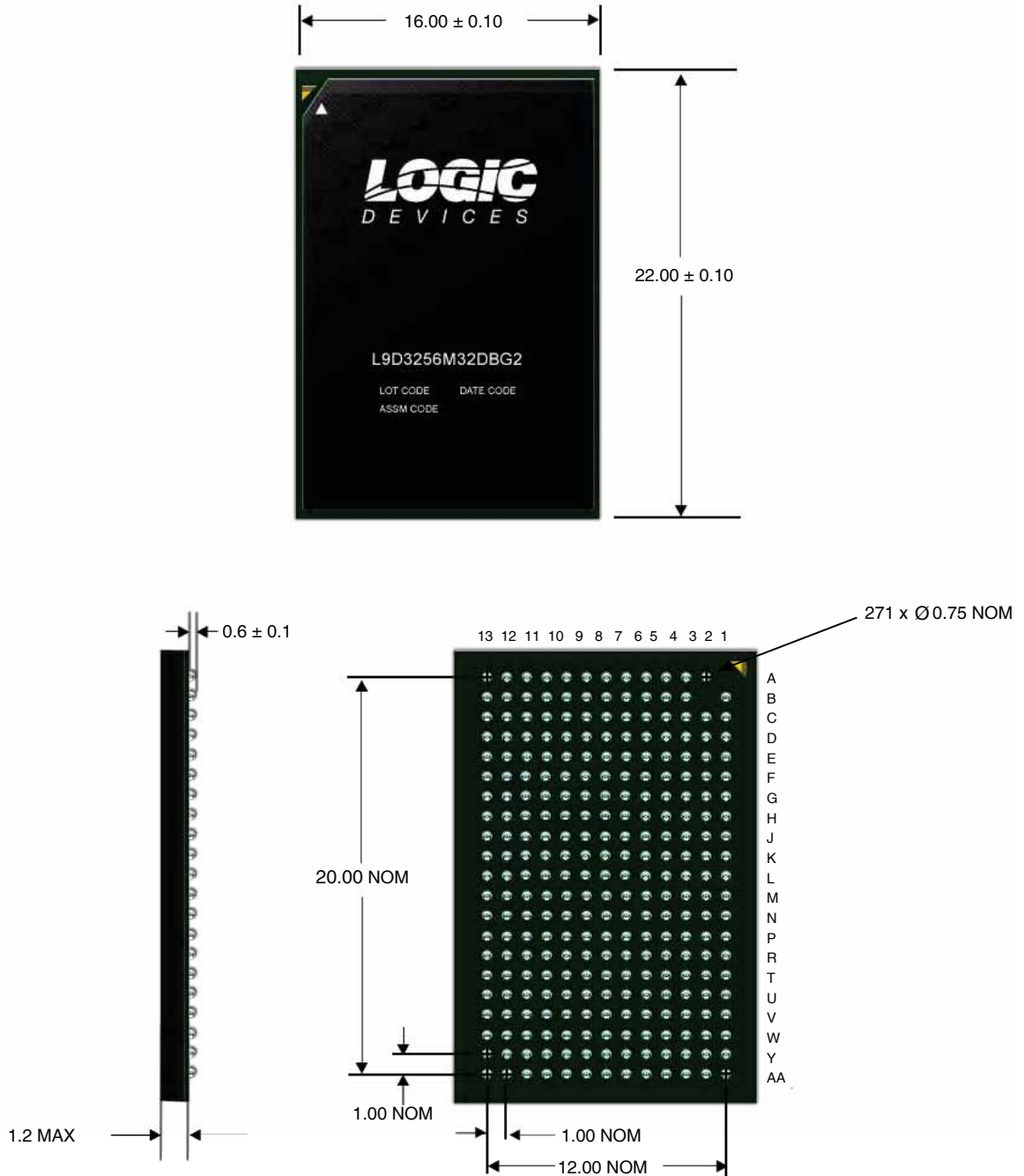
TABLE 2 - BALL/SIGNAL LOCATION AND DESCRIPTION CONTINUED			
Ball Assignments	Symbol	Type	Description
R12	ODTB	Input	<b>On-Die Termination:</b> ODT enables (when registered HIGH) and disables termination resistance internal to the DDR3 SDRAM. When enabled in normal operation, ODT is only applied to each of the following signals: DQ[63:0], DQSx#, and DMx. The ODT input is ignored if disabled via the LOAD MODE register command. ODT is referenced to VrefCA.
U9	RESETB#	Input	<b>RESET:</b> An input control pin, active LOW referenced to Vss. The RESET# input receiver is a CMOS input defined as a rail to rail signal with DC HIGH $\geq 0.8 \times V_{DD}$ and DC LOW $\leq 0.2 \times V_{DDQ}$ . RESET# assertion and de-assertion are asynchronous.
T5, T6, U5, U6 N3, N4, Y2, Y3	DQSxB, DQSxB#	Input	<b>Data Strobe, Byte (per WORD):</b> Output, edge-aligned with READ data. Input, center-aligned with WRITE data.
U1, U2, U3, U4, W4, W5, W6, W7	DQ0B, DQ1B, DQ2B, DQ3B, DQ4B, DQ5B, DQ6B, DQ7B	I/O	<b>Data Input/Output:</b> LOW Byte, LOW WORD (WORD 1). Pin referenced to VrefDQ.
W1, W2, W3, Y1, Y4, Y5, Y6, Y7	DQ8B, DQ9B, DQ10B, DQ11B, DQ12B, DQ13B, DQ14B, DQ15B	I/O	<b>Data Input/Output:</b> HIGH Byte, LOW WORD (WORD 1). Pin referenced to VrefDQ.
P3, P4, P5, P6, T1, T2, T3, T4	DQ16B, DQ17B, DQ18B, DQ19B, DQ20B, DQ21B, DQ22B, DQ23B	I/O	<b>Data Input/Output:</b> LOW Byte, WORD 2. Pin referenced to VrefDQ.
L3, L4, N1, N2, N5, N6, P1, P2	DQ24B, DQ25B, DQ26B, DQ27B, DQ28B, DQ29B, DQ30B, DQ31B	I/O	<b>Data Input/Output:</b> HIGH Byte, WORD 2. Pin referenced to VrefDQ.
M9	VSSDLLB		Ground for DLL
N9	VDDDLLB		Supply for DLL
T10	VrefCAB	Supply	Voltage Reference CORE: VrefCA must be maintained at all times
P9	VrefDAB	Supply	Voltage Reference I/O: VrefDQ must be maintained at all times.

16-32 Gb, DDR3, 256-512M x 32 Dual Channel Memory Module

TABLE 2 - BALL/SIGNAL LOCATION AND DESCRIPTION CONTINUED			
Ball Assignments	Symbol	Type	Description
A12, B8, D8, E8, E13, F12, G8, H7, H13, J8, J10, K11, L6, L8, L10, L12, M11, N8, N10, P7, P13, R8, T12, U8, U13, V8, Y8, AA12	V <sub>DD</sub>	Supply	Power Supply: 1.35V ± 0.0675V
A2, A4, A6, D1, D3, D5, D7, F7, G2, G4, G6, K1, K3, K5, K7, M2, M4, M6, R1, R3, R5, R7, U7, V2, V4, V6, AA1, AA3, AA5, AA7	V <sub>DDQ</sub>	Supply	Data I/O Supply: 1.35V ± 0.0675V
A8, A13, C8, E12, F8, F13, H8, H10, J7, J13, K8, K10, L5, L7, L9, L11, L13, M8, M10, N7, N13, P8, P10, T8, T13, U12, W8, AA8, AA13 A1, A3, A5, A7, D2, D4,	V <sub>SS</sub>	Supply	Ground
D6, E7, G1, G3, G5, G7, K2, K4, K6, M1, M3, M5, M7, R2, R4, R6, T7, V1, V3, V5, V7, AA2, AA4, AA6	V <sub>SSQ</sub>	Supply	Data I/O Ground: Isolated from Core for improved noise immunity
F9, G9, R9, T9	RFU		Reserved for Future Use

16-32 Gb, DDR3, 256-512M x 32 Dual Channel Memory Module

FIGURE 5 - MECHANICAL DRAWING



Note: All dimensions in mm

## 16-32 Gb, DDR3, 256-512M x 32 Dual Channel Memory Module

**TABLE 3: ABSOLUTE MAXIMUM RATINGS**

Symbol	Parameter	MIN	MAX	UNITS	NOTES
V <sub>DD</sub>	V <sub>DD</sub> Supply Voltage relative to V <sub>SS</sub>	-0.4	1.78	V	1
V <sub>DDQ</sub>	V <sub>DDQ</sub> Supply Voltage relative to V <sub>SSQ</sub>	-0.4	1.78	V	1
V <sub>IN</sub> , V <sub>OUT</sub>	Voltage on any pin relative to V <sub>SS</sub>	-0.4	1.78	V	1
T <sub>AI</sub> ndustrial	Operating Ambient Temperature	-40	85	°C	2,3
T <sub>A</sub> Extended	Operating Ambient Temperature	-40	105	°C	2,3
T <sub>A</sub> Miltemp	Operating Ambient Case Temperature	-55	125	°C	2,3
T <sub>STG</sub>	Storage Temperature	-55	150	°C	2,3

NOTES:

- V<sub>DD</sub> and V<sub>DDQ</sub> must be within 300mV of each other at all times and V<sub>REF</sub> must not be greater than 0.6 x V<sub>DDQ</sub>. When V<sub>DD</sub> and V<sub>DDQ</sub> are less than 500mV, V<sub>REF</sub> may be ≤300mV.
- Max operating ambient temperature. T<sub>A</sub> is measured in the center of the package.
- Device Functionality is not guaranteed if the DRAM device exceeds the Maximum T<sub>A</sub> during operation.

**TABLE 4: INPUT/OUTPUT CAPACITANCE**

Capacitance Parameter	Symbol	MIN	MAX (256M)	MAX (512M)	UNITS	NOTES
CK and CK\	C <sub>CK</sub>	1.6	3.2	6.4	pF	
Single-end I/O: DQ, DM	C <sub>I0</sub>	1.4	2.2	4.4	pF	2
Differential I/O: DQS, DQS\	C <sub>I0</sub>	1.4	2.2	4.4	pF	3
Inputs (RAS\, CAS\, WE\, CS\, CKE, RESET\, ADDR, /BA0-2)	C <sub>I_Shared</sub>	1.5	2.8	5.6	pF	5

NOTES:

- V<sub>DD</sub> = +1.35V -0.0675mV/+0.1V, V<sub>DDQ</sub> = V<sub>DD</sub>, V<sub>REF</sub> = V<sub>SS</sub>, f = 100MHz, T<sub>A</sub> = 25°C, V<sub>OUT</sub> (DC) = 0.5 x V<sub>DDQ</sub>, V<sub>OUT</sub> (peak to peak) = 0.1V
- DM input is grouped with I/O pins, reflecting the signal is grouped with DQ and therefore matched in loading.
- C<sub>CCQS</sub> is for DQS vs. DQS\
- C<sub>DI0</sub> = C<sub>I0</sub> (DQ) - 0.5 x (C<sub>I0</sub> [DQS] + C<sub>I0</sub> [DQS\])
- Excludes CK, CK\
- C<sub>DI\_CNTL</sub> = C<sub>I</sub>(CNTL) - 0.5 x (C<sub>CK</sub>[CK] + C<sub>CK</sub>[CK\]); CNTL = ODT, CS\ and CKE
- C<sub>DI\_CMD\_ADDR</sub> = C<sub>I</sub> (CMD\_ADDR) - 0.5 x (C<sub>CK</sub> [CK] + C<sub>CK</sub> [CK\]); CMD = RAS\, CAS\, and WE\ ADDR = [n:0]

## 16-32 Gb, DDR3, 256-512M x 32 Dual Channel Memory Module

TABLE 5: TIMING PARAMETERS FOR IDD MEASUREMENTS - CLOCK UNITS					
		DDR3-1333 -15	DDR3-1600 -12	DDR3-1866 -11	
IDD Parameter		10-10-10	11-11-11	13-13-13	
t <sub>CK</sub> (MIN) IDD		1.5	1.25	1.071	ns
CL IDD		10	11	13	CK
t <sub>RCD</sub> (MIN) IDD		10	11	13	CK
t <sub>RC</sub> (MIN) IDD		34	39	45	CK
t <sub>RAS</sub> (MIN) IDD		24	28	32	CK
t <sub>RP</sub> (MIN) IDD		10	11	13	CK
t <sub>FAW</sub>	x64	30	32	33	CK
t <sub>RRD</sub> IDD	x64	5	6	6	CK
t <sub>RFC</sub>		174	208	243	CK

**16-32 Gb, DDR3, 256-512M x 32 Dual Channel Memory Module**

**TABLE 6: I<sub>DD0</sub> MEASUREMENT LOOP**

Sub-Loop	Cycle Number	Command	CS <sub>i</sub>	RAS <sub>i</sub>	CAS <sub>i</sub>	WE <sub>i</sub>	ODT	BA [2:0]	A [15:11]	A [10]	A [9:7]	A [6:3]	A [2:0]	Data	
0	0	ACT	0	0	1	1	0	0	0	0	0	0	0	-	
	1	D	1	0	0	0	0	0	0	0	0	0	0	-	
	2	D	1	0	0	0	0	0	0	0	0	0	0	-	
	3	D <sub>i</sub>	1	1	1	1	0	0	0	0	0	0	0	-	
	4	D <sub>i</sub>	1	1	1	1	0	0	0	0	0	0	0	-	
	-														
	nRAS	PRE	0	0	0	1	0	0	0	0	0	0	0	0	-
	-														
	nRC	ACT	0	0	0	1	0	0	0	0	0	0	0	0	-
	nRC+1	D	1	0	0	0	0	0	0	0	0	0	F	0	-
	nRC+2	D	1	0	0	0	0	0	0	0	0	0	F	0	-
	nRC+3	D <sub>i</sub>	1	1	1	1	0	0	0	0	0	0	F	0	-
nRC+4	D <sub>i</sub>	1	1	1	1	0	0	0	0	0	0	F	0	-	
-															
nRC + nRAS	PRE	0	0	0	1	0	0	0	0	0	0	0	0	-	
-															
2 x nRC															
4 x nRC															
6 x nRC															
8 x nRC															
10 x nRC															
12 x nRC															
14 x nRC															
CKE	Static HIGH														
CK, CK <sub>i</sub>	Toggling														



16-32 Gb, DDR3, 256-512M x 32 Dual Channel Memory Module

**TABLE 7: I<sub>DD1</sub> MEASUREMENT LOOP**

Sub-Loop	Cycle Number	Command	CS <sub>i</sub>	RAS <sub>i</sub>	CAS <sub>i</sub>	WE <sub>i</sub>	ODT	BA [2:0]	A [15:11]	A [10]	A [9:7]	A [6:3]	A [2:0]	Data	
0	0	ACT	0	0	1	1	0	0	0	0	0	0	0	-	
	1	D	1	0	0	0	0	0	0	0	0	0	0	-	
	2	D	1	0	0	0	0	0	0	0	0	0	0	-	
	3	DI	1	1	1	1	0	0	0	0	0	0	0	-	
	4	DI	1	1	1	1	0	0	0	0	0	0	0	-	
	-	-	-	-	-	-	-	-	-	-	-	-	-	-	
	nRCD	RD	0	1	0	1	0	0	0	0	0	0	0	0	00000000
	-	-	-	-	-	-	-	-	-	-	-	-	-	-	-
	nRAS	PRE	0	0	1	0	0	0	0	0	0	0	0	0	-
	-	-	-	-	-	-	-	-	-	-	-	-	-	-	-
	nRC	ACT	0	0	1	1	0	0	0	0	0	0	F	0	-
	nRC +1	D	1	0	0	0	0	0	0	0	0	0	F	0	-
	nRC +2	D	1	0	0	0	0	0	0	0	0	0	F	0	-
	nRC +3	DI	1	1	1	1	0	0	0	0	0	0	F	0	-
	nRC +4	DI	1	1	1	1	0	0	0	0	0	0	F	0	-
	-	-	-	-	-	-	-	-	-	-	-	-	-	-	-
nRC + nRCD	RD	0	1	0	1	0	0	0	0	0	0	F	0	00110011	
-	-	-	-	-	-	-	-	-	-	-	-	-	-	-	
nRC + nRAS	PRE	0	0	1	0	0	0	0	0	0	0	F	0	-	
2xnRC	-	-	-	-	-	-	-	-	-	-	-	-	-	-	
2xnRC	-	-	-	-	-	-	-	-	-	-	-	-	-	-	
2xnRC	-	-	-	-	-	-	-	-	-	-	-	-	-	-	
2xnRC	-	-	-	-	-	-	-	-	-	-	-	-	-	-	
2xnRC	-	-	-	-	-	-	-	-	-	-	-	-	-	-	
2xnRC	-	-	-	-	-	-	-	-	-	-	-	-	-	-	
2xnRC	-	-	-	-	-	-	-	-	-	-	-	-	-	-	

Static HIGH

Toggling

## 16-32 Gb, DDR3, 256-512M x 32 Dual Channel Memory Module

**TABLE 8: I<sub>DD</sub> MEASUREMENT CONDITIONS FOR POWER-DOWN CURRENTS**

Name	I <sub>DD</sub> 2P0 Precharge Power- Down Current (Slow Exit)	I <sub>DD</sub> 2P1 Precharge Power- Down Current (Fast Exit)	I <sub>DD</sub> 2Q Precharge Quiet Standby Current	I <sub>DD</sub> 3P Active Power- Down Current
Timing Pattern	n/a	n/a	n/a	n/a
CKE	LOW	LOW	HIGH	LOW
External Clock	Toggling	Toggling	Toggling	Toggling
t <sub>CK</sub>	t <sub>CK</sub> (MIN) I <sub>DD</sub>	t <sub>CK</sub> (MIN) I <sub>DD</sub>	t <sub>CK</sub> (MIN) I <sub>DD</sub>	t <sub>CK</sub> (MIN) I <sub>DD</sub>
t <sub>RC</sub>	n/a	n/a	n/a	n/a
t <sub>RAS</sub>	n/a	n/a	n/a	n/a
t <sub>RCD</sub>	n/a	n/a	n/a	n/a
t <sub>RRD</sub>	n/a	n/a	n/a	n/a
t <sub>RC</sub>	n/a	n/a	n/a	n/a
CL	n/a	n/a	n/a	n/a
AL	n/a	n/a	n/a	n/a
CS\	HIGH	HIGH	HIGH	HIGH
Command Inputs	LOW	LOW	LOW	LOW
ROW/COLUMN Addr	LOW	LOW	LOW	LOW
Bank Address	LOW	LOW	LOW	LOW
DM	LOW	LOW	LOW	LOW
Data I/O	Mid-level	Mid-level	Mid-level	Mid-level
Output Buffer DQ, DQS	Enabled	Enabled	Enabled	Enabled
ODT	Enabled, OFF	Enabled, OFF	Enabled, OFF	Enabled, OFF
Burst Length	8	8	8	8
ACTIVE Bank(s)	None	None	None	None
IDLE Bank(s)	All	All	All	All
Special Notes	n/a	n/a	n/a	n/a

16-32 Gb, DDR3, 256-512M x 32 Dual Channel Memory Module

**TABLE 9: I<sub>DD2N</sub> / I<sub>DD3N</sub> MEASUREMENT LOOP**

Sub-Loop	Cycle Number	Command	CS <sub>i</sub>	RAS <sub>i</sub>	CAS <sub>i</sub>	WE <sub>i</sub>	ODT	BA [2:0]	A [15:11]	A [10]	A [9:7]	A [6:3]	A [2:0]	Data
0	0	D	1	0	0	0	0	0	0	0	0	0	0	-
	1	D	1	0	0	0	0	0	0	0	0	0	0	-
	2	DI	1	1	1	0	0	0	0	0	0	F	0	-
1	3	DI	1	1	1	1	0	0	0	0	0	F	0	-
	4-7						Repeat sub-loop 0, use BA [2:0] = 1							
	8-11						Repeat sub-loop 0, use BA [2:0] = 2							
	12-15						Repeat sub-loop 0, use BA [2:0] = 3							
	16-19						Repeat sub-loop 0, use BA [2:0] = 4							
	20-23						Repeat sub-loop 0, use BA [2:0] = 5							
	24-27						Repeat sub-loop 0, use BA [2:0] = 6							
28-31						Repeat sub-loop 0, use BA [2:0] = 7								
CKE	Static HIGH													
CK, CK <sub>i</sub>	Toggling													

## 16-32 Gb, DDR3, 256-512M x 32 Dual Channel Memory Module

**TABLE 10: I<sub>DD2NT</sub> MEASUREMENT LOOP**

Sub-Loop	Cycle Number	Command	CS <sub>i</sub>	RAS <sub>i</sub>	CAS <sub>i</sub>	WE <sub>i</sub>	ODT	BA [2:0]	A [15:11]	A [10]	A [9:7]	A [6:3]	A [2:0]	Data
0	0	D	1	0	0	0	0	0	0	0	0	0	0	-
	1	D	1	0	0	0	0	0	0	0	0	0	0	-
	2	DI	1	1	1	1	0	0	0	0	0	F	0	-
1	3	DI	1	1	1	1	0	0	0	0	0	F	0	-
	4-7						Repeat sub-loop 0, use BA [2:0] = 1; ODT = 0							
	8-11						Repeat sub-loop 0, use BA [2:0] = 2; ODT = 1							
	12-15						Repeat sub-loop 0, use BA [2:0] = 3; ODT = 1							
	16-19						Repeat sub-loop 0, use BA [2:0] = 4; ODT = 0							
	20-23						Repeat sub-loop 0, use BA [2:0] = 5; ODT = 0							
	24-27						Repeat sub-loop 0, use BA [2:0] = 6; ODT = 1							
28-31						Repeat sub-loop 0, use BA [2:0] = 7; ODT = 1								
CKE	Static HIGH													
CK, CKI	Toggling													

16-32 Gb, DDR3, 256-512M x 32 Dual Channel Memory Module

**TABLE 11: I<sub>DD4R</sub> MEASUREMENT LOOP**

Sub-Loop	Cycle Number	Command	CS\	RAS\	CAS\	WE\	ODT	BA [2:0]	A [15:11]	A [10]	A [9:7]	A [6:3]	A [2:0]	Data	
0	0	RD	0	1	0	1	0	0	0	0	0	0	0	00000000	
	1	D	1	0	0	0	0	0	0	0	0	0	0	-	
	2	DA	1	1	1	1	0	0	0	0	0	0	0	-	
	3	DA	1	1	1	1	0	0	0	0	0	0	0	-	
	4	RD	0	1	0	1	0	0	0	0	0	F	0	00110011	
	5	D	1	0	0	0	0	0	0	0	0	F	0	-	
	6	DA	1	1	1	1	0	0	0	0	0	F	0	-	
7	DA	1	1	1	1	0	0	0	0	0	F	0	-		
1	8-15	Repeat sub-loop 0, use BA [2:0] = 1													
2	16-23	Repeat sub-loop 0, use BA [2:0] = 2													
3	24-31	Repeat sub-loop 0, use BA [2:0] = 3													
4	32-39	Repeat sub-loop 0, use BA [2:0] = 4													
5	40-47	Repeat sub-loop 0, use BA [2:0] = 5													
6	48-55	Repeat sub-loop 0, use BA [2:0] = 6													
7	56-63	Repeat sub-loop 0, use BA [2:0] = 7													
CKE	Static HIGH														
CK, CKI	Toggling														

16-32 Gb, DDR3, 256-512M x 32 Dual Channel Memory Module

**TABLE 12: I<sub>DD4W</sub> MEASUREMENT LOOP**

Sub-Loop	Cycle Number	Command	CS\	RAS\	CAS\	WE\	ODT	BA [2:0]	A [15:11]	A [10]	A [9:7]	A [6:3]	A [2:0]	Data	
0	0	WR	0	1	0	0	1	0	0	0	0	0	0	00000000	
	1	D	1	0	0	0	1	0	0	0	0	0	0	-	
	2	D\	1	1	1	1	1	0	0	0	0	0	0	-	
	3	D\	1	1	1	1	1	0	0	0	0	0	0	-	
	4	WR	0	1	0	0	1	0	0	0	0	0	0	00110011	
	5	D	1	0	0	0	1	0	0	0	0	0	0	-	
	6	D\	1	1	1	1	1	0	0	0	0	0	0	-	
7	D\	1	1	1	1	1	0	0	0	0	0	0	-		
1	8-15	Repeat sub-loop 0, use BA [2:0] = 1													
2	16-23	Repeat sub-loop 0, use BA [2:0] = 2													
3	24-31	Repeat sub-loop 0, use BA [2:0] = 3													
4	32-39	Repeat sub-loop 0, use BA [2:0] = 4													
5	40-47	Repeat sub-loop 0, use BA [2:0] = 5													
6	48-55	Repeat sub-loop 0, use BA [2:0] = 6													
7	56-63	Repeat sub-loop 0, use BA [2:0] = 7													
CKE	Static HIGH														
CK, CK\	Toggling														

## 16-32 Gb, DDR3, 256-512M x 32 Dual Channel Memory Module

**TABLE 13: I<sub>DD5B</sub> MEASUREMENT LOOP**

Sub-Loop	Cycle Number	Command	CS <sub>i</sub>	RAS <sub>i</sub>	CAS <sub>i</sub>	WE <sub>i</sub>	ODT	BA [2:0]	A [15:11]	A [10]	A [9:7]	A [6:3]	A [2:0]	Data
0	0	REF												
1a	1	D												
	2	D												
	3	D <sub>i</sub>												
	4	D <sub>i</sub>												
1b	5-8													
1c	9-12							Repeat sub-loop 1a, use BA [2:0] = 1						
1d	13-16							Repeat sub-loop 1a, use BA [2:0] = 2						
1e	17-20							Repeat sub-loop 1a, use BA [2:0] = 3						
1f	21-24							Repeat sub-loop 1a, use BA [2:0] = 4						
1g	25-28							Repeat sub-loop 1a, use BA [2:0] = 5						
1h	29-32							Repeat sub-loop 1a, use BA [2:0] = 6						
2	33-nRFC-1							Repeat sub-loop 1a through 1h until RFC - 1, truncate if needed						
CKE		Static HIGH												
CK, CK <sub>i</sub>		Toggling												

## 16-32 Gb, DDR3, 256-512M x 32 Dual Channel Memory Module

**TABLE 14: I<sub>DD</sub> MEASUREMENT LOOP**

I <sub>DD</sub> Test	Industrial Range T <sub>A</sub> = -40°C to 85°C	Extended or Mil Temperature Range, T <sub>A</sub> = -40°C to 85°C or -55°C to 125°C	
	<b>I<sub>DD6</sub>: Self Refresh Current</b>	<b>I<sub>DD6E/M</sub>: Self Refresh Current</b>	<b>I<sub>DD8</sub>: Reset</b>
CKE	LOW	LOW	Mid-level
External Clock	Off, CK and CK\ = LOW	Off, CK and CK\ = LOW	Mid-level
t <sub>CK</sub>	n/a	n/a	n/a
t <sub>RC</sub>	n/a	n/a	n/a
t <sub>RAS</sub>	n/a	n/a	n/a
t <sub>RCD</sub>	n/a	n/a	n/a
t <sub>RRD</sub>	n/a	n/a	n/a
t <sub>RC</sub>	n/a	n/a	n/a
CL	n/a	n/a	n/a
AL	n/a	n/a	n/a
CS\	Mid-level	Mid-level	Mid-level
Command Inputs	Mid-level	Mid-level	Mid-level
ROW/COLMUN addresses	Mid-level	Mid-level	Mid-level
BANK addresses	Mid-level	Mid-level	Mid-level
Data I/O	Mid-level	Mid-level	Mid-level
Output buffer DQ, DQS	Enabled	Enabled	Mid-level
ODT	Enabled, Mid-level	Enabled, Mid-level	Mid-level
Burst Length	n/a	n/a	n/a
Active BANKS	n/a	n/a	None
IDLE BANKS	n/a	n/a	All
SRT	Disabled (normal)	Enabled (extended)	n/a
ASR	Disabled	Disabled	n/a



16-32 Gb, DDR3, 256-512M x 32 Dual Channel Memory Module

**TABLE 15: I<sub>dd7</sub> MEASUREMENT LOOP**

Sub-Loop	Cycle Number	Command	CS <sub>i</sub>	RAS <sub>i</sub>	CAS <sub>i</sub>	WE <sub>i</sub>	ODT	BA [2:0]	A [15:11]	A [10]	A [9:7]	A [6:3]	A [2:0]	Data	
0	0	ACT	0	0	1	1	0	0	0	0	0	0	0	-	
	1	RDA	0	1	0	1	0	0	0	1	0	0	0	00000000	
	2	D	1	0	0	0	0	0	0	0	0	0	0	-	
1	3	Repeat cycle 2 until $n \cdot \text{RRD} - 1$													
	$n \cdot \text{RRD}$	ACT	0	0	1	1	0	1	0	0	0	0	F	0	
	$n \cdot \text{RRD} + 1$	RDA	0	1	0	1	0	1	0	1	0	0	F	0	
2	$n \cdot \text{RRD} + 2$	D	1	0	0	0	0	1	0	0	0	F	0	-	
	$n \cdot \text{RRD} + 3$	Repeat cycle $n \cdot \text{RRD} + 2$ until $2 \times n \cdot \text{RRD} - 1$													
	$2 \times n \cdot \text{RRD}$	Repeat sub-loop 0, use BA[2:0] = 2													
3	$3 \times n \cdot \text{RRD}$	Repeat sub-loop 0, use BA[2:0] = 3													
	$4 \times n \cdot \text{RRD}$	D	1	0	0	0	0	3	0	0	0	F	0	-	
	$4 \times n \cdot \text{RRD} + 1$	Repeat cycle $4 \times n \cdot \text{RRD}$ until $n \cdot \text{FAW} - 1$ , if needed													
4	$n \cdot \text{FAW}$	Repeat sub-loop 0, use BA[2:0] = 4													
	$n \cdot \text{FAW} + n \cdot \text{RRD}$	Repeat sub-loop 1, use BA[2:0] = 5													
	$n \cdot \text{FAW} + 2 \times n \cdot \text{RRD}$	Repeat sub-loop 0, use BA[2:0] = 6													
5	$n \cdot \text{FAW} + 3 \times n \cdot \text{RRD}$	Repeat sub-loop 1, use BA[2:0] = 7													
	$n \cdot \text{FAW} + 4 \times n \cdot \text{RRD}$	D	1	0	0	0	0	7	0	0	0	F	0	-	
	$n \cdot \text{FAW} + 4 \times n \cdot \text{RRD} + 1$	Repeat cycle $n \cdot \text{FAW} + 4 \times n \cdot \text{RRD}$ until $2 \times n \cdot \text{FAW} - 1$ , if needed													
6	$2 \times n \cdot \text{FAW}$	ACT	0	0	1	1	0	0	0	0	0	F	0	-	
	$2 \times n \cdot \text{FAW} + 1$	RDA	0	1	0	1	0	0	0	1	0	F	0	00110011	
	$2 \times n \cdot \text{FAW} + 2$	D	1	0	0	0	0	0	0	0	0	F	0	-	
7	$2 \times n \cdot \text{FAW} + 3$	Repeat cycle $2 \times n \cdot \text{FAW} + 2$ until $2 \times n \cdot \text{FAW} + n \cdot \text{RRD} - 1$													
	$2 \times n \cdot \text{FAW} + n \cdot \text{RRD}$	ACT	0	0	1	1	0	1	0	0	0	0	0	-	
	$2 \times n \cdot \text{FAW} + n \cdot \text{RRD} + 1$	RDA	0	1	0	1	0	1	0	1	0	0	0	00000000	
8	$2 \times n \cdot \text{FAW} + n \cdot \text{RRD} + 2$	D	1	0	0	0	0	1	0	0	0	0	0	-	
	$2 \times n \cdot \text{FAW} + n \cdot \text{RRD} + 3$	Repeat cycle $2 \times n \cdot \text{FAW} + n \cdot \text{RRD} + 2$ until $2 \times n \cdot \text{FAW} + 2 \times n \cdot \text{RRD} - 1$													
	$2 \times n \cdot \text{FAW} + 2 \times n \cdot \text{RRD}$	Repeat sub-loop 10, use BA[2:0] = 2													
9	$2 \times n \cdot \text{FAW} + 3 \times n \cdot \text{RRD}$	Repeat sub-loop 11, use BA[2:0] = 3													
	$2 \times n \cdot \text{FAW} + 4 \times n \cdot \text{RRD}$	D	1	0	0	0	0	3	0	0	0	0	0	-	
	$2 \times n \cdot \text{FAW} + 4 \times n \cdot \text{RRD} + 1$	Repeat cycle $2 \times n \cdot \text{FAW} + 4 \times n \cdot \text{RRD}$ until $3 \times n \cdot \text{FAW} - 1$ , if needed													
10	$3 \times n \cdot \text{FAW}$	Repeat sub-loop 10, use BA[2:0] = 4													
	$3 \times n \cdot \text{FAW} + 2 \times n \cdot \text{RRD}$	Repeat sub-loop 11, use BA[2:0] = 5													
	$3 \times n \cdot \text{FAW} + 2 \times n \cdot \text{RRD} + 1$	Repeat sub-loop 10, use BA[2:0] = 6													
11	$3 \times n \cdot \text{FAW} + 3 \times n \cdot \text{RRD}$	Repeat sub-loop 11, use BA[2:0] = 7													
	$3 \times n \cdot \text{FAW} + 4 \times n \cdot \text{RRD}$	D	1	0	0	0	0	7	0	0	0	0	0	-	
	$3 \times n \cdot \text{FAW} + 4 \times n \cdot \text{RRD} + 1$	Repeat cycle $3 \times n \cdot \text{FAW} + 4 \times n \cdot \text{RRD}$ until $4 \times n \cdot \text{FAW} - 1$ , if needed													

**16-32 Gb, DDR3, 256-512M x 32 Dual Channel Memory Module**

<b>TABLE 16A: IDD MAXIMUM LIMITS (256M)</b>					
<b>Speed Bin</b>					
<b>IDD</b>		<b>DDR3-1333</b>	<b>DDR3-1600</b>	<b>DDR3-1866</b>	<b>UNITS</b>
I <sub>DD0</sub>		320	360	400	mA
I <sub>DD1</sub>		440	460	480	mA
I <sub>DD2P0</sub>		80	80	80	mA
I <sub>DD2P1</sub>		128	148	168	mA
I <sub>DD2Q</sub>		176	188	208	mA
I <sub>DD2N</sub>		200	220	240	mA
I <sub>DD3P</sub>		232	252	272	mA
I <sub>DD3N</sub>		292	308	328	mA
I <sub>DD4R</sub>		960	1120	1200	mA
I <sub>DD4W</sub>		800	900	1000	mA
I <sub>DD5B</sub>		840	880	920	mA
I <sub>DD6</sub>		88	88	88	mA
I <sub>DD7</sub>		1040	1140	1280	mA
I <sub>DD8</sub>	IND	I <sub>DD2P</sub> + 2mA	I <sub>DD2P</sub> + 2mA	I <sub>DD2P</sub> + 2mA	mA
	EXT	I <sub>DD2P</sub> + 2mA	I <sub>DD2P</sub> + 2mA	I <sub>DD2P</sub> + 2mA	mA
	MIL-TEMP	I <sub>DD2P</sub> + 2mA	I <sub>DD2P</sub> + 2mA	I <sub>DD2P</sub> + 2mA	mA

NOTES: TA = 0°C to ≤ 85°C; SRT and ASR are disabled, enabling ASR could increase IDD<sub>x</sub> by up to an additional 2mA.

<b>TABLE 16B: IDD MAXIMUM LIMITS (512M)</b>					
<b>Speed Bin</b>					
<b>IDD</b>		<b>DDR3-1333</b>	<b>DDR3-1600</b>	<b>DDR3-1866</b>	<b>UNITS</b>
I <sub>DD0</sub>		640	720	800	mA
I <sub>DD1</sub>		880	920	960	mA
I <sub>DD2P0</sub>		160	160	160	mA
I <sub>DD2P1</sub>		256	296	336	mA
I <sub>DD2Q</sub>		352	376	416	mA
I <sub>DD2N</sub>		400	440	480	mA
I <sub>DD3P</sub>		464	504	544	mA
I <sub>DD3N</sub>		584	616	656	mA
I <sub>DD4R</sub>		1920	2240	2400	mA
I <sub>DD4W</sub>		1600	1800	2000	mA
I <sub>DD5B</sub>		1680	1760	1840	mA
I <sub>DD6</sub>		176	176	176	mA
I <sub>DD7</sub>		2080	2280	2560	mA
I <sub>DD8</sub>	IND	I <sub>DD2P</sub> + 2mA	I <sub>DD2P</sub> + 2mA	I <sub>DD2P</sub> + 2mA	mA
	EXT	I <sub>DD2P</sub> + 2mA	I <sub>DD2P</sub> + 2mA	I <sub>DD2P</sub> + 2mA	mA
	MIL-TEMP	I <sub>DD2P</sub> + 2mA	I <sub>DD2P</sub> + 2mA	I <sub>DD2P</sub> + 2mA	mA

NOTES: TA = 0°C to ≤ 85°C; SRT and ASR are disabled, enabling ASR could increase IDD<sub>x</sub> by up to an additional 2mA.

## 16-32 Gb, DDR3, 256-512M x 32 Dual Channel Memory Module

**TABLE 17: DC ELECTRICAL CHARACTERISTICS AND OPERATING CONDITIONS**

All Voltages are referenced to V <sub>SS</sub>						
Parameter/Condition	Symbol	MIN	TYP	MAX	UNITS	NOTES
Supply Voltage	V <sub>DD</sub>	1.2825	1.35	1.4175	V	1,2
I/O Supply Voltage	V <sub>DDQ</sub>	1.2825	1.35	1.4175	V	1,2
Input Leakage Current: Any input 0V ≤ V <sub>IN</sub> ≤ V <sub>DD</sub> , V <sub>REF</sub> pin 0V ≤ V <sub>IN</sub> ≤ 1.1V All other pins not under test = 0V	I <sub>I</sub>	-4	-	4	μA	
V <sub>REF</sub> Supply Leakage Current: V <sub>REFDQ</sub> = V <sub>DD</sub> /2 or V <sub>REFCA</sub> = V <sub>DD</sub> /2 All other pins not under test = 0V	I <sub>VREF</sub>	-4	-	4	μA	3,4

NOTES:

- V<sub>DD</sub> and V<sub>DDQ</sub> must track one another, V<sub>DDQ</sub> must be less than or equal to V<sub>DD</sub>, V<sub>SS</sub> = V<sub>SSQ</sub>.
- V<sub>DD</sub> and V<sub>DDQ</sub> may include AC noise of ± 50mV (250 kHz to 20MHz) in addition to the DC (0Hz to 250kHz) specifications, V<sub>DD</sub> and V<sub>DDQ</sub> must be at the same level for valid AC timing parameters.
- V<sub>REF</sub> (see Table 19).
- The minimum limit requirement is for testing purposes. The leakage current on the V<sub>REF</sub> pin should be minimal.

**TABLE 18: DC ELECTRICAL CHARACTERISTICS AND INPUT CONDITIONS**

All Voltages are referenced to V <sub>SS</sub>						
Parameter/Condition	Symbol	MIN	TYP	MAX	UNITS	NOTES
V <sub>IN</sub> low; DC/commands/address busses	V <sub>IL</sub>	V <sub>SS</sub>	n/a	See Table 17	V	
V <sub>IN</sub> high; DC/commands/address busses	V <sub>IH</sub>	See Table 17	n/a	V <sub>DD</sub>	V	
Input reference voltage command/address bus	V <sub>REFCA</sub> (DC)	0.49 x V <sub>DD</sub>	0.5 x V <sub>DD</sub>	0.51 x V <sub>DD</sub>	V	1,2
I/O reference voltage DQ bus	V <sub>REFDQ</sub> (DC)	0.49 x V <sub>DD</sub>	0.5 x V <sub>DD</sub>	0.51 x V <sub>DD</sub>	V	2,3
I/O reference voltage DQ bus in SELF REFRESH	V <sub>REFDQ</sub> (SR)	V <sub>SS</sub>	0.5 x V <sub>DD</sub>	V <sub>DD</sub>	V	4
Command/address termination voltage (system level, not direct DRAM input)	V <sub>TT</sub>	-	0.5 x V <sub>DDQ</sub>	-	V	5

NOTES:

- V<sub>REFCA</sub>(DC) is expected to be approximately 0.5 x V<sub>DD</sub> and to track variations in the DC level. Externally generated peak noise (noncommon mode) on V<sub>REFCA</sub> may not exceed ± 1% x V<sub>DD</sub> around the V<sub>REFCA</sub>(DC) value. Peak-to-peak AC noise on V<sub>REFCA</sub> should not exceed ± 2% of V<sub>REFCA</sub>(DC).
- DC values are determined to be less than 20MHz in frequency. DRAM must meet specifications if the DRAM induces additional AC noise greater than 20MHz in frequency.
- V<sub>REFDQ</sub>(DC) is expected to be approximately 0.5 x V<sub>DD</sub> and to track variations in the DC level. Externally generated peak noise (noncommon mode) on V<sub>REFDQ</sub> may not exceed ± 1% x V<sub>DD</sub> around the V<sub>REFDQ</sub>(DC) value. Peak-to-peak AC noise on V<sub>REFDQ</sub> should not exceed ± 2% of V<sub>REFDQ</sub>(DC).
- V<sub>REFDQ</sub>(DC) may transition to V<sub>REFDQ</sub>(SR) and back to V<sub>REFDQ</sub>(DC) when in SELF zREFRESH, within restrictions outlined in the SELF REFRESH section.
- V<sub>TT</sub> is not applied directly to the device. V<sub>TT</sub> is a system supply for signal termination resistors. MIN and MAX values are system-dependent.

## 16-32 Gb, DDR3, 256-512M x 32 Dual Channel Memory Module

**TABLE 19: INPUT SWITCHING CONDITIONS**

Parameter/Condition	Symbol	DDR3-1333 DDR3-1600	DDR3-1866	UNITS
<b>Command and Address</b>				
Input high AC voltage: Logic 1	$V_{IH} (AC175) \text{ MIN}$	+175	-	mV
Input high AC voltage: Logic 1	$V_{IH} (AC150) \text{ MIN}$	+150	-	mV
Input high DC voltage: Logic 1	$V_{IH} (DC100) \text{ MIN}$	+100	+100	mV
Input high DC voltage: Logic 0	$V_{IL} (DC100) \text{ MAX}$	-100	-100	mV
Input high AC voltage: Logic 0	$V_{IL} (AC150) \text{ MAX}$	-150	-	mV
Input high AC voltage: Logic 0	$V_{IL} (AC175) \text{ MAX}$	-175	-	mV
<b>DQ and DM</b>				
Input high AC voltage: Logic 1	$V_{IH} (AC175) \text{ MIN}$	-	-	mV
Input high AC voltage: Logic 1	$V_{IH} (AC150) \text{ MIN}$	+150	-	mV
Input high DC voltage: Logic 1	$V_{IH} (DC100) \text{ MIN}$	+100	+100	mV
Input high DC voltage: Logic 0	$V_{IL} (DC100) \text{ MAX}$	-100	-100	mV
Input high AC voltage: Logic 0	$V_{IL} (AC150) \text{ MAX}$	-150	-	mV
Input high AC voltage: Logic 0	$V_{IL} (AC175) \text{ MAX}$	-	-	mV

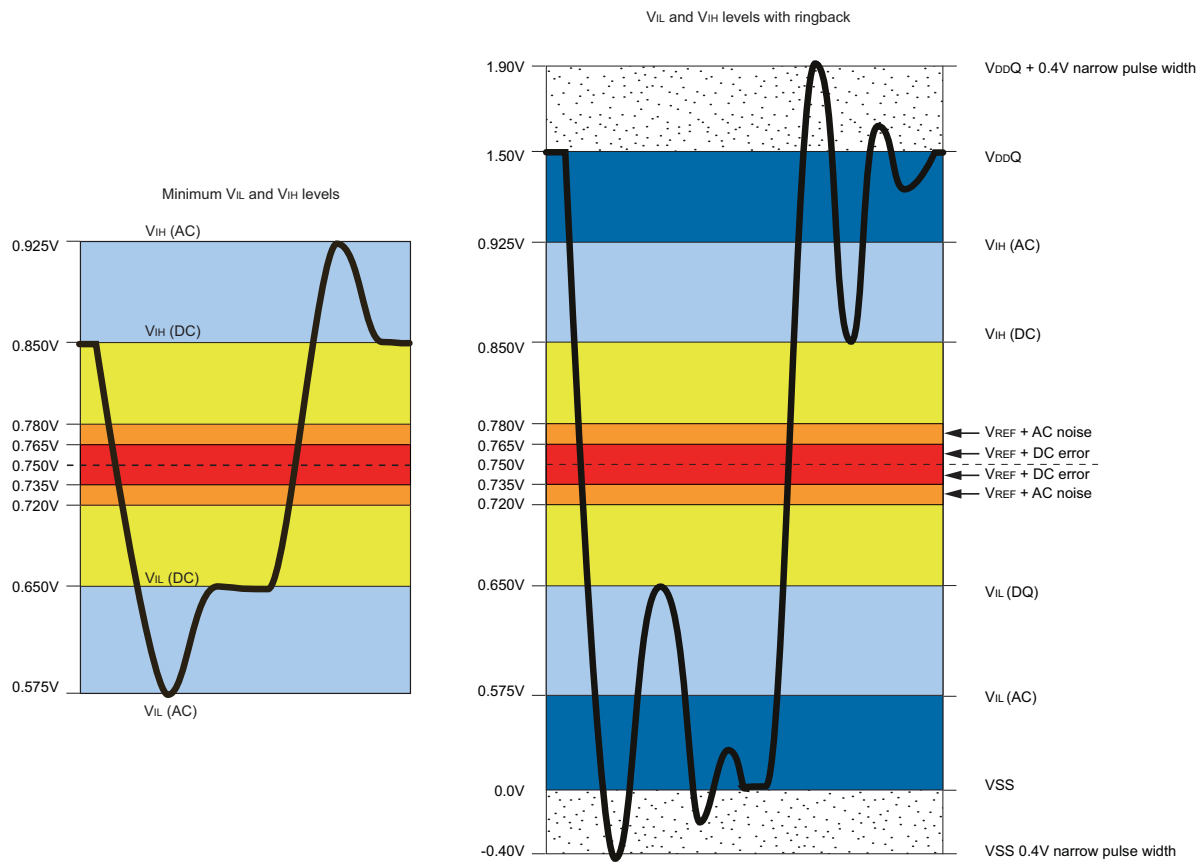
NOTES:

- All voltages are referenced to  $V_{REF}$ ,  $V_{REF}$  is  $V_{REFCA}$  for control, command, and address. All slew rates and setup/hold times are specified at the DRAM ball.  $V_{REF}$  is  $V_{REFDQ}$  for DQ and DM inputs.
- Input setup timing parameters ( $t_{IS}$  and  $t_{DS}$ ) are referenced at  $V_{IL}(AC)/V_{IH}(AC)$ , not  $V_{REF}(DC)$ .
- Input hold timing parameters ( $t_{IH}$  and  $t_{DH}$ ) are referenced at  $V_{IL}(DC)/V_{IH}(DC)$ , not  $V_{REF}(AC)$ .
- Single-ended input slew rate = 1V/ns; maximum input voltage swing under test is 900mV (peak-to-peak).

16-32 Gb, DDR3, 256-512M x 32 Dual Channel Memory Module

**OPERATING CONDITIONS**

**FIGURE 6 - INPUT SIGNAL**



Notes: 1. Numbers in diagrams reflect nominal values.

16-32 Gb, DDR3, 256-512M x 32 Dual Channel Memory Module

**AC OVERSHOOT/UNDERSHOOT SPECIFICATION**

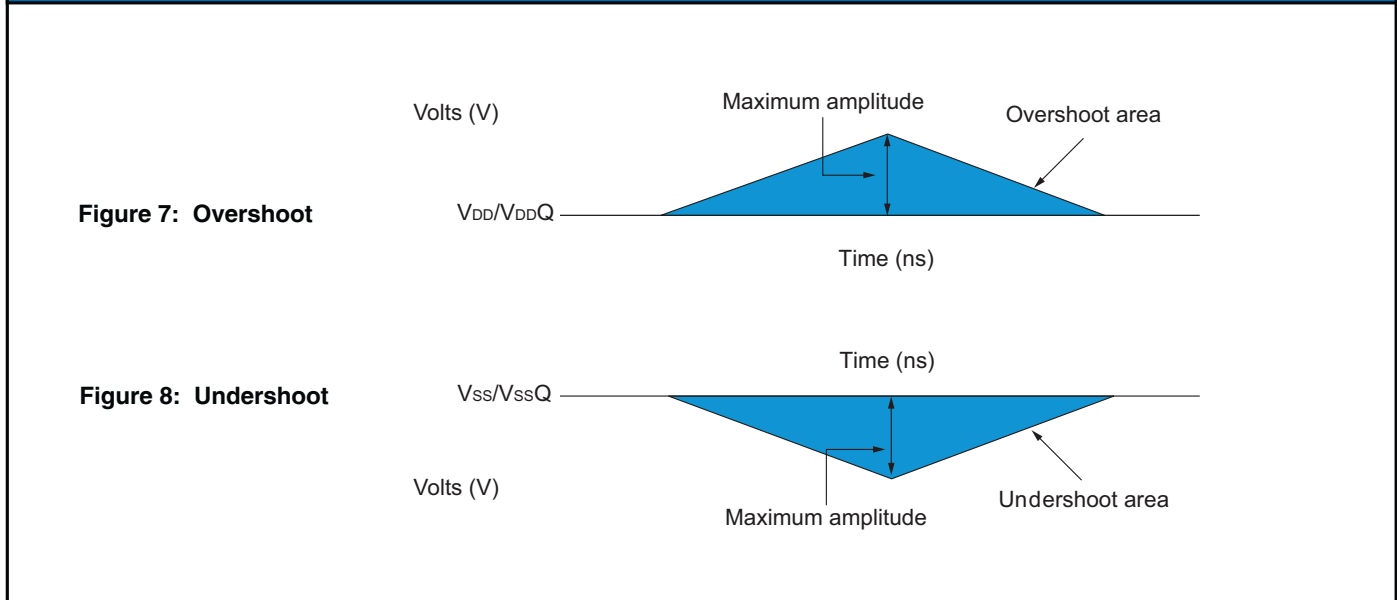
**TABLE 20: CONTROL AND ADDRESS PINS**

Parameter	DDR3-1333	DDR3-1600	DDR3-1866
Maximum peak amplitude allowed for overshoot area (see Figure 7)	0.4V	0.4V	0.4V
Maximum peak amplitude allowed for undershoot area (see Figure 8)	0.4V	0.4V	0.4V
Maximum overshoot area above $V_{cc}$ (see Figure 7)	0.4Vns	0.33Vns	0.28Vns
Maximum undershoot area below $V_{ss}$ (see Figure 8)	0.4Vns	0.33Vns	0.28Vns

**TABLE 21: CLOCK, DATA, STROBE, AND MASK PINS**

Parameter	DDR3-1333	DDR3-1600	DDR3-1866
Maximum peak amplitude allowed for overshoot area (see Figure 7)	0.4V	0.4V	0.4V
Maximum peak amplitude allowed for undershoot area (see Figure 8)	0.4V	0.4V	0.4V
Maximum overshoot area above $V_{cc}/V_{ccQ}$ (see Figure 7)	0.15Vns	0.13Vns	0.11Vns
Maximum undershoot area below $V_{ss}/V_{ssQ}$ (see Figure 8)	0.15Vns	0.13Vns	0.11Vns

**FIGURE 7 & 8: OVERSHOOT/UNDERSHOOT SPECIFICATIONS**



## 16-32 Gb, DDR3, 256-512M x 32 Dual Channel Memory Module

**TABLE 22: DIFFERENTIAL INPUT OPERATING CONDITIONS (CK<sub>X</sub>, CK<sub>X</sub>\, DQS<sub>X</sub>, AND DQS<sub>X</sub>\)**

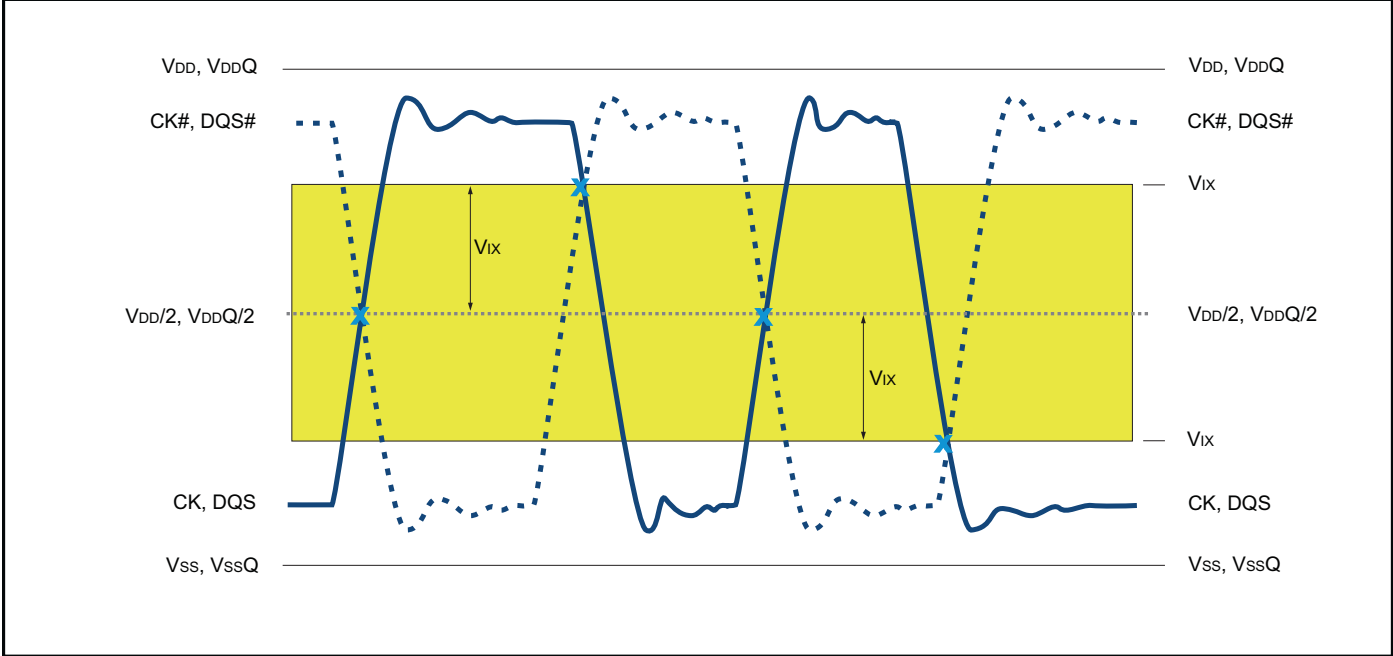
Parameter/Condition	Symbol	MIN	MAX	UNITS	NOTES
Differential input voltage, logic high - slew	V <sub>IH</sub> DIFF(AC)slew	+200	n/a	mV	4
Differential input voltage, logic low - slew	V <sub>IL</sub> DIFF(AC)slew	n/a	-200	mV	4
Differential input voltage, logic high	V <sub>IH</sub> DIFF(AC)	2x(V <sub>IH</sub> (AC)-V <sub>REF</sub> )	V <sub>DD</sub> /V <sub>DDQ</sub>	mV	5
Differential input voltage, logic low	V <sub>IL</sub> DIFF(AC)	V <sub>SS</sub> /V <sub>SSQ</sub>	2x(V <sub>REF</sub> -V <sub>IL</sub> (AC))	mV	6
Differential input crossing voltage relative to V <sub>DD</sub> /2 for DQS, DQS\, CK, CK\	V <sub>Ix</sub>	V <sub>REF</sub> (DC) - 150	V <sub>REF</sub> (DC) + 150	mV	7
Differential input crossing voltage relative to V <sub>DD</sub> /2 for CK, CK\	V <sub>Ix</sub> (175)	V <sub>REF</sub> (DC) - 175	V <sub>REF</sub> (DC) + 175	mV	7,8
Single-ended high level for strobes	V <sub>SHE</sub>	V <sub>DDQ</sub> /2 + V <sub>IH</sub> (AC)	V <sub>DDQ</sub>	mV	5
Single-ended high level for CK, CK\		V <sub>DD</sub> /2 + V <sub>IH</sub> (AC)	V <sub>DD</sub>		
Single-ended low level for strobes	V <sub>SEL</sub>	V <sub>SSQ</sub>	V <sub>DDQ</sub> /2-V <sub>IL</sub> (AC)	mV	6
Single-ended low level for CK, CK\		V <sub>SS</sub>	V <sub>DD</sub> /2-V <sub>IL</sub> (AC)		

NOTES:

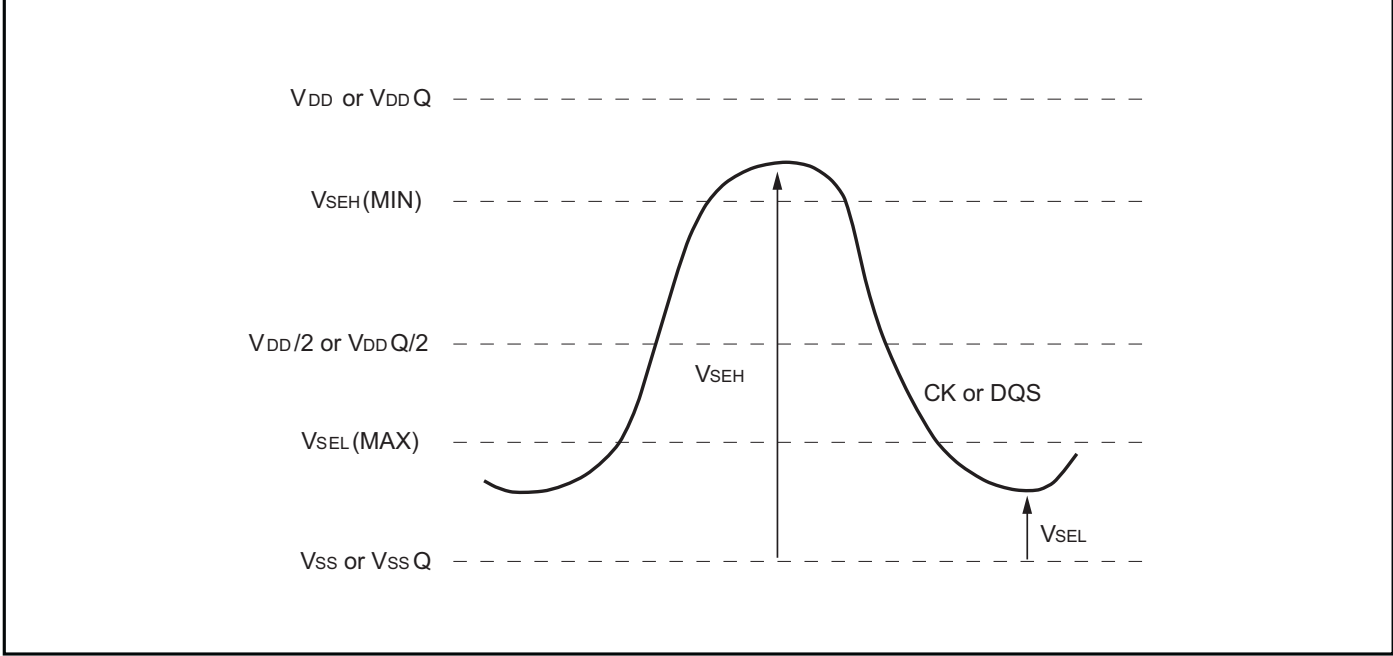
1. Clock is referenced to V<sub>DD</sub>D and V<sub>SS</sub>. Data strobe is referenced to V<sub>DD</sub>Q and V<sub>SS</sub>Q.
2. Reference is V<sub>REF</sub>CA(DC) for clock and for V<sub>REF</sub>DQ(DC) for strobe.
3. Differential input slew rate = 2V/ms.
4. Defines slew rate reference points relative to input crossing voltages.
5. MAX limit is relative to single-ended signals, the overshoot specifications are applicable.
6. MIN limit is relative to single-ended signals, the undershoot specifications are applicable.
7. The typical value of V<sub>Ix</sub>(AC) is expected to be about 0.5 x V<sub>DD</sub> of the transmitting device and V<sub>Ix</sub>(AC) is expected to track variations in V<sub>DD</sub>. V<sub>Ix</sub>(AC) indicates the voltage at which differential input signals must cross.
8. The V<sub>Ix</sub> extended range (±175mV) is allowed only for the clock and this V<sub>Ix</sub> extended range is only allowed when the following conditions are met: The single-ended input signals are monotonic, have the single-ended swing V<sub>SEL</sub>, V<sub>SEH</sub> of at least V<sub>DD</sub>/2 ±250mV, and the differential slew rate of CK, CK\ is greater than 3V/ns.

**OVERSHOOT/UNDERSHOOT SPECIFICATIONS**

**FIGURE 9 - V<sub>ix</sub> FOR DIFFERENTIAL SIGNALS**



**FIGURE 10 - SINGLE-ENDED REQUIREMENTS FOR DIFFERENTIAL SIGNALS**

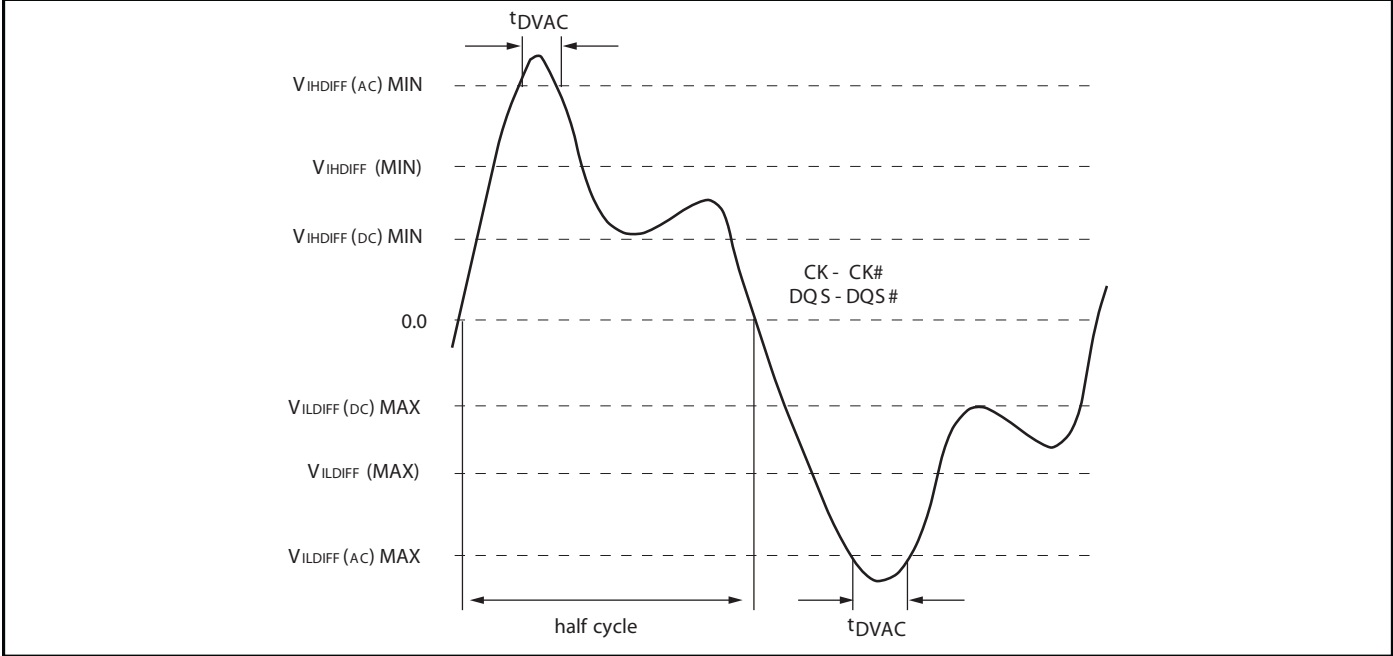




16-32 Gb, DDR3, 256-512M x 32 Dual Channel Memory Module

**OVERSHOOT/UNDERSHOOT SPECIFICATIONS**

**FIGURE 11 - DEFINITION OF DIFFERENTIAL AC-SWING AND tDVAC**



**TABLE 23: DIFFERENTIAL INPUT OPERATING CONDITIONS (tDVAC) FOR CK<sub>X</sub>, CK<sub>X</sub>#, DQS<sub>X</sub>, AND DQS<sub>X</sub>#**

Below  $V_{IL}$  (AC)

Slew Rate (V/ns)	tDVAC (ps) at [V <sub>IHDIFF(AC)</sub> to V <sub>ILDIFF(AC)</sub> ]	
	350mV	300mV
-4.0	75	175
4.0	57	170
3.0	50	167
2.0	38	163
1.9	34	162
1.6	29	161
1.4	22	159
1.2	13	155
1.0	0	150
<1.0	0	150

## 16-32 Gb, DDR3, 256-512M x 32 Dual Channel Memory Module

### SLEW RATE DEFINITIONS FOR SINGLE-ENDED INPUT SIGNALS

Setup (<sup>1</sup>IS and <sup>1</sup>DS) nominal slew rate for a rising signal is defined as the slew-rate between the last crossing of VREF and the first crossing of VIH(AC) MIN. Setup (<sup>1</sup>IS and <sup>1</sup>DS) nominal slew rate for a falling signal is defined as the slew rate between the last crossing of VREF and the first crossing of VIL(AC) MAX.

Hold (<sup>1</sup>IH and <sup>1</sup>DH) nominal slew rate for a rising signal is defined as the slew rate between the last crossing of VIL(DC) MAX and the first crossing of VREF. Hold (<sup>1</sup>IH and <sup>1</sup>DH) nominal slew rate for a falling signal is defined as the slew rate between the last crossing of VIH(DC) MIN and the first crossing of VREF.

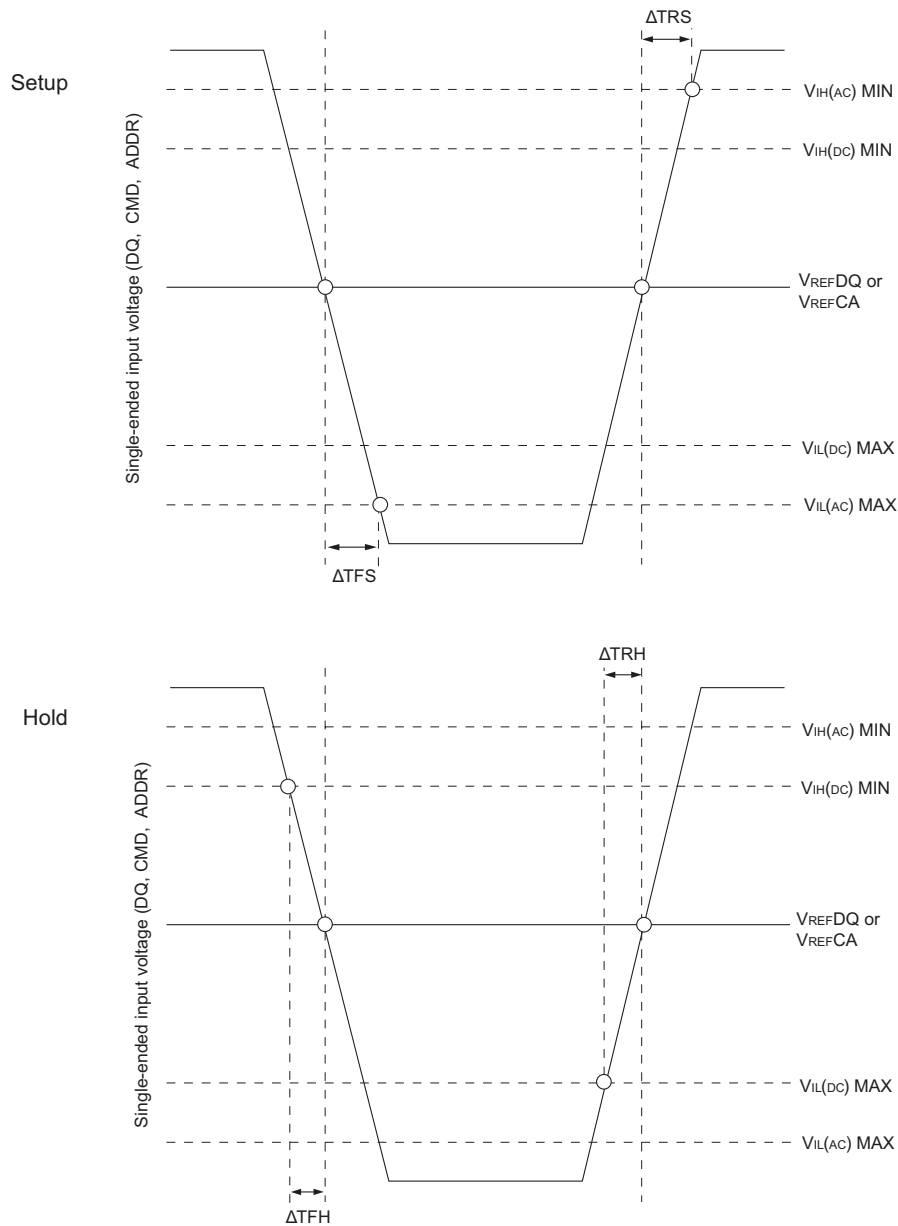
**TABLE 24: SINGLE-ENDED INPUT SLEW RATE**

Input Slew Rate (Linear Signals)		Measured		Calculation
Input	Edge	From	To	
Setup	Rising	VREF	VIH(AC)MIN	$V_{IH(AC) MIN} - V_{REF}$
	Falling	VREF	VIL(AC)MAX	$\frac{V_{REF} - V_{IL(AC) MAX}}{\Delta T_{FS}}$
Hold	Rising	VIL(DC)Max	VREF	$\frac{V_{REF} - V_{IL(DC) MAX}}{\Delta T_{FH}}$
	Falling	VIH(DC)MIN	VREF	$\frac{V_{IH(DC) MIN} - V_{REF}}{\Delta T_{RSH}}$

16-32 Gb, DDR3, 256-512M x 32 Dual Channel Memory Module

**SLEW RATE DEFINITIONS FOR SINGLE-ENDED INPUT SIGNALS**

**FIGURE 12 - NOMINAL SLEW RATE DEFINITION FOR SINGLE-ENDED INPUT SIGNALS**



**16-32 Gb, DDR3, 256-512M x 32 Dual Channel Memory Module**

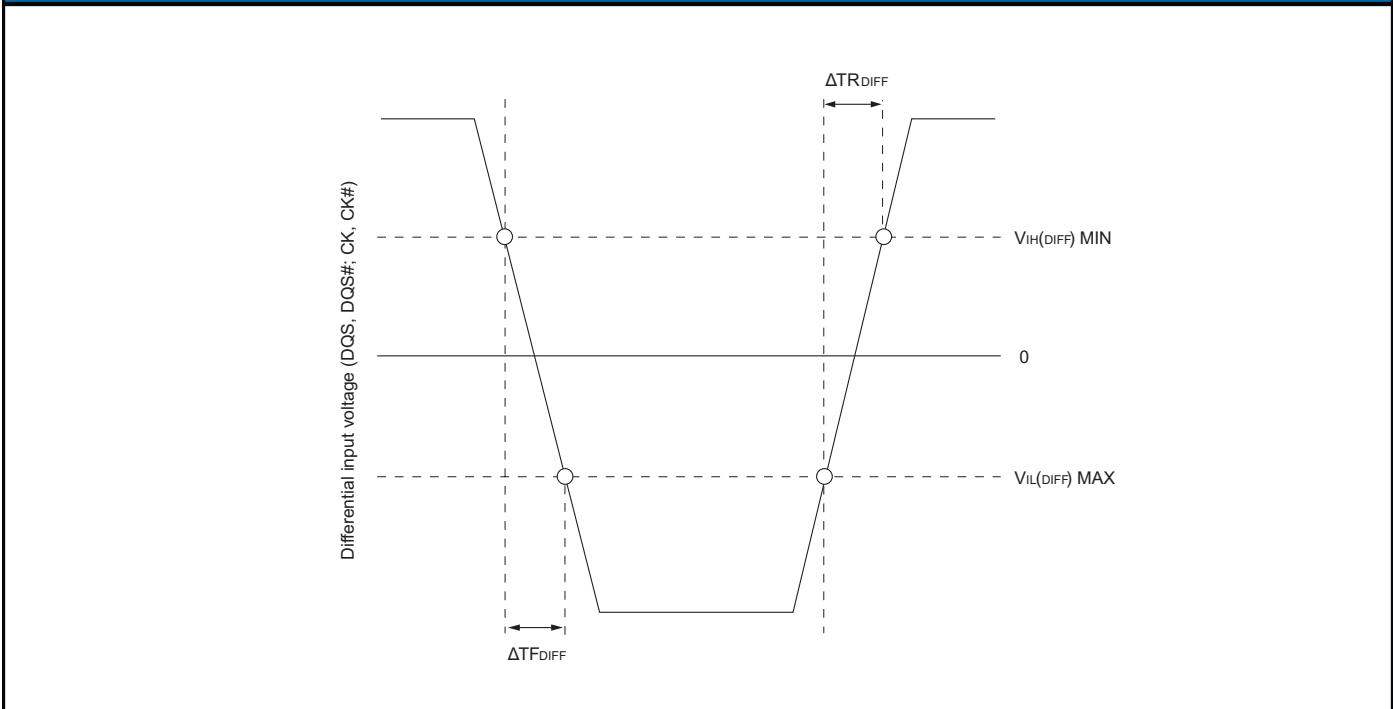
**SLEW RATE DEFINITIONS FOR DIFFERENTIAL INPUT SIGNALS**

Input slew rate for differential signals (CKx, CKx<sup>l</sup>, UDQSx, UDQSx<sup>l</sup>, LDQSx and LDQSx<sup>l</sup>) are defined and measured as shown in Table 25. The nominal slew rate for a rising signal is defined as the slew rate between V<sub>IL(DIFF) MAX</sub> and V<sub>IH(DIFF) MIN</sub>. The nominal slew rate for a falling signal is defined as the slew rate between V<sub>IH(DIFF) MIN</sub> and V<sub>IL(DIFF) MAX</sub>.

**TABLE 25: DIFFERENTIAL INPUT SLEW RATE DEFINITION**

Input Slew Rate (Linear Signals)		Measured		Calculation
Input	Edge	From	To	
CK and DQS Reference	Rising	V <sub>REF</sub>	V <sub>IH(AC)MIN</sub>	$\frac{V_{IH(DIFF) MIN} - V_{IL(DIFF) MAX}}{\Delta TR(DIFF)}$
	Falling	V <sub>REF</sub>	V <sub>IL(AC)MAX</sub>	$\frac{V_{IH(DIFF) MIN} - V_{IL(DIFF) MAX}}{\Delta TF(DIFF)}$

**FIGURE 13 - NOMINAL DIFFERENTIAL INPUT SLEW RATE DEFINITION FOR DQS, DQS# AND CK, CK#**

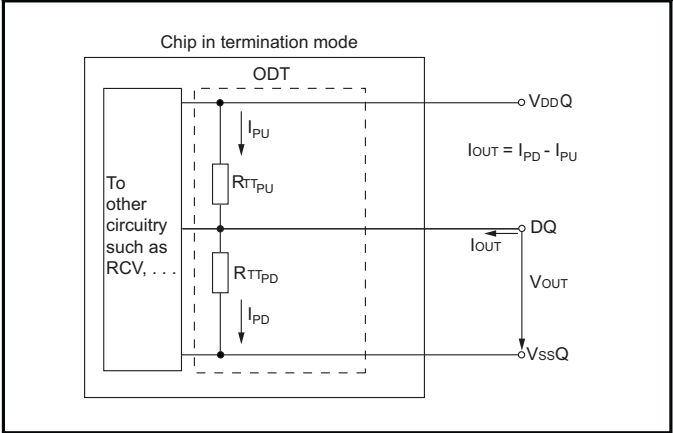


**16-32 Gb, DDR3, 256-512M x 32 Dual Channel Memory Module**

**ODT CHARACTERISTICS**

ODT's effective resistance  $R_{TT}$  is defined by MR1[9,6 and 2]. ODT is applied to the DQx, UDMx, LDMx, UDQSx, UDQSx\, LDQSx and LDQSx\ balls. The ODT target values are listed in Table 29.

**FIGURE 14 - ODT LEVELS AND I-V CHARACTERISTICS**



**TABLE 26: ON-DIE TERMINATION DC ELECTRICAL CHARACTERISTICS**

Parameter/Condition	Symbol	MIN	TYP	MAX	UNITS	NOTES
$R_{TT}$ effective impedance	$R_{TT\_EFF}$	See Table 27				1, 2, 4
Deviation of VM with respect to $V_{DDQ}/2$	$\Delta VM$	-5		5	%	1, 2, 3, 4

NOTES:

1. Tolerance limits are applicable after a proper ZQ calibration has been performed at a stable temperature and voltage ( $V_{DDQ}=V_{DD}$ ,  $V_{SSQ}=V_{SS}$ ). Refer to "ODT Sensitivity" on page 38 if either the temperature or voltage changes after calibration.
2. Measurement definition for  $R_{TT}$ : Apply  $V_{IH(AC)}$  to a pin under test and measure the current  $I[V_{IH(AC)}]$ , then apply  $V_{IL(AC)}$  to pin under test and measure current  $I[V_{IL(AC)}]$ :

$$R_{TT} = \frac{V_{IL(AC)} - V_{IH(AC)}}{I[V_{IH(AC)}] - I[V_{IL(AC)}]}$$

3. Measure voltage (VM) at the tested pin with no load:

$$\Delta VM = \left[ \frac{2 \times VM}{V_{DDQ}} - 1 \right] \times 100$$

4. For extended MIL-temp devices, the minimum values are derated by 6% when the device is between  $-40^{\circ}C$  and  $0^{\circ}C$  (TA).

**16-32 Gb, DDR3, 256-512M x 32 Dual Channel Memory Module**

TABLE 27: RTT EFFECTIVE IMPEDANCES							
MR1 [9,6,2]	RTT	Resistor	VOUT	MIN	TYP	MAX	UNITS
0, 1, 0	120Ω	RTT120PD240	0.2 x V <sub>DDQ</sub>	0.6	1.0	1.1	RZQ/1
			0.5 x V <sub>DDQ</sub>	0.9	1.0	1.1	RZQ/1
			0.8 x V <sub>DDQ</sub>	0.9	1.0	1.4	RZQ/1
		RTT120PU240	0.2 x V <sub>DDQ</sub>	0.9	1.0	1.4	RZQ/1
			0.5 x V <sub>DDQ</sub>	0.9	1.0	1.1	RZQ/1
			0.8 x V <sub>DDQ</sub>	0.9	1.0	1.1	RZQ/1
120Ω		V <sub>IL</sub> (AC) to V <sub>IH</sub> (AC)	0.9	1.0	1.6	RZQ/2	
0, 0, 1	60Ω	RTT60PD120	0.2 x V <sub>DDQ</sub>	0.6	1.0	1.1	RZQ/2
			0.5 x V <sub>DDQ</sub>	0.9	1.0	1.1	RZQ/2
			0.8 x V <sub>DDQ</sub>	0.9	1.0	1.4	RZQ/2
		RTT60PU240	0.2 x V <sub>DDQ</sub>	0.9	1.0	1.4	RZQ/2
			0.5 x V <sub>DDQ</sub>	0.9	1.0	1.1	RZQ/2
			0.8 x V <sub>DDQ</sub>	0.9	1.0	1.1	RZQ/2
60Ω		V <sub>IL</sub> (AC) to V <sub>IH</sub> (AC)	0.9	1.0	1.6	RZQ/4	
0, 1, 1	40Ω	RTT40PD80	0.2 x V <sub>DDQ</sub>	0.6	1.0	1.1	RZQ/3
			0.5 x V <sub>DDQ</sub>	0.9	1.0	1.1	RZQ/3
			0.8 x V <sub>DDQ</sub>	0.9	1.0	1.4	RZQ/3
		RTT40PU80	0.2 x V <sub>DDQ</sub>	0.9	1.0	1.4	RZQ/3
			0.5 x V <sub>DDQ</sub>	0.9	1.0	1.1	RZQ/3
			0.8 x V <sub>DDQ</sub>	0.9	1.0	1.1	RZQ/3
40Ω		V <sub>IL</sub> (AC) to V <sub>IH</sub> (AC)	0.9	1.0	1.6	RZQ/6	
1, 0, 1	30Ω	RTT30PD60	0.2 x V <sub>DDQ</sub>	0.6	1.0	1.1	RZQ/4
			0.5 x V <sub>DDQ</sub>	0.9	1.0	1.1	RZQ/4
			0.8 x V <sub>DDQ</sub>	0.9	1.0	1.4	RZQ/4
		RTT30PU60	0.2 x V <sub>DDQ</sub>	0.9	1.0	1.4	RZQ/4
			0.5 x V <sub>DDQ</sub>	0.9	1.0	1.1	RZQ/4
			0.8 x V <sub>DDQ</sub>	0.9	1.0	1.1	RZQ/4
30Ω		V <sub>IL</sub> (AC) to V <sub>IH</sub> (AC)	0.9	1.0	1.6	RZQ/8	
1, 0, 0	20Ω	RTT20PD40	0.2 x V <sub>DDQ</sub>	0.6	1.0	1.1	RZQ/6
			0.5 x V <sub>DDQ</sub>	0.9	1.0	1.1	RZQ/6
			0.8 x V <sub>DDQ</sub>	0.9	1.0	1.4	RZQ/6
		RTT20PU40	0.2 x V <sub>DDQ</sub>	0.9	1.0	1.4	RZQ/6
			0.5 x V <sub>DDQ</sub>	0.9	1.0	1.1	RZQ/6
			0.8 x V <sub>DDQ</sub>	0.9	1.0	1.1	RZQ/6
20Ω		V <sub>IL</sub> (AC) to V <sub>IH</sub> (AC)	0.9	1.0	1.6	RZQ/12	

**16-32 Gb, DDR3, 256-512M x 32 Dual Channel Memory Module**

**ODT SENSITIVITY**

If either the temperature or voltage changes after I/O calibration, the tolerance limits listed in Table 26 can be expected to widen according to Tables 28 and 29.

**TABLE 28: ODT SENSITIVITY DEFINITION**

Symbol	MIN	MAX	UNITS
R <sub>TT</sub>	$0.9 - dR_{TTdT} \times dR_{TTdV} \times [DV]$	$1.6 + dR_{TTdT} \times [DT] + dR_{TTdV} \times [DV]$	RZQ/(2, 4, 6, 8, 12)

**TABLE 29 - ODT TEMPERATURE & VOLTAGE SENSITIVITY**

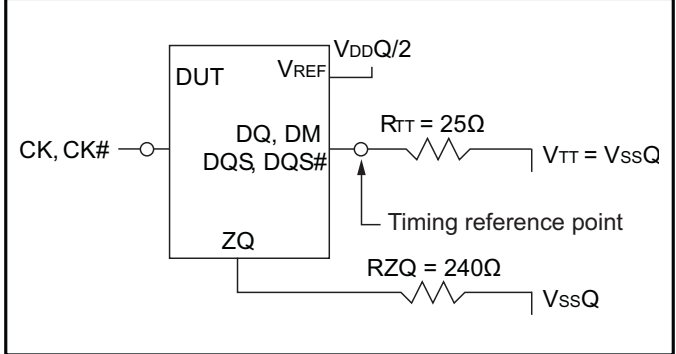
Change	MIN	MAX	UNITS
dR <sub>TTdT</sub>	0	1.5	0
dR <sub>TTdV</sub>	0	0.15	0

**ODT TIMING DEFINITIONS**

ODT loading differs from that used in AC timing measurements. Two parameters define when ODT turns on or off synchronously, two define when ODT turns on or off Asynchronously and, another defines when ODT turns on or off dynamically. Table 30 outlines and provides definition and measurement reference settings for each parameter.

ODT turn-on time begins when the output leaves HIGH-Z and ODT resistance begins to turn on. ODT turn-off time begins when the output leaves LOW-Z and ODT resistance begins to turn-off.

**FIGURE 15 - ODT TIMING REFERENCE LOAD**



## 16-32 Gb, DDR3, 256-512M x 32 Dual Channel Memory Module

### ODT TIMING DEFINITIONS

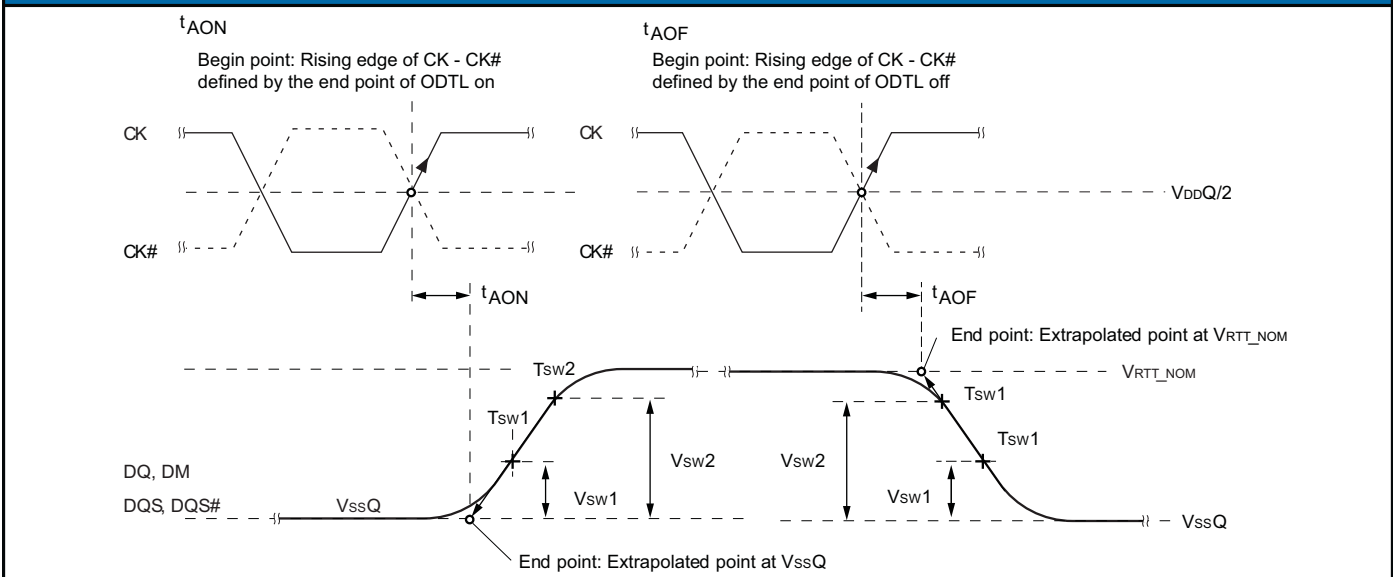
**TABLE 30: ODT TIMING DEFINITIONS**

Symbol	Begin Point Definition	End Point Definition	Figure
<b>t<sub>AON</sub></b>	Rising edge of CK-CK\ defined by the end point of ODTL on	Extrapolated point at V <sub>ssQ</sub>	Figure 25 on page 61
<b>t<sub>AOFF</sub></b>	Rising edge of CK-CK\ defined by the end point of ODTL off	Extrapolated point at VR <sub>TT_NORM</sub>	Figure 25 on page 61
<b>t<sub>AONPD</sub></b>	Rising edge of CK-CK\ with ODT first being registered HIGH	Extrapolated point at V <sub>ssQ</sub>	Figure 26 on page 62
<b>t<sub>AOFPD</sub></b>	Rising edge of CK-CK\ with ODT first being registered LOW	Extrapolated point at VR <sub>TT_NOM</sub>	Figure 26 on page 62
<b>t<sub>ADC</sub></b>	Rising edge of CK-CK\ defined by the end point of ODTLCNW, ODTLCWN4, or ODTLCWN8	Extrapolated points at VR <sub>TT_WR</sub> and VR <sub>TT_NOM</sub>	Figure 27 on page 63

**TABLE 31: REFERENCE SETTINGS FOR ODT TIMING MEASUREMENTS**

Measured Parameter	R <sub>TT_NORM</sub> Setting	R <sub>TT_WR</sub> Setting	V <sub>SW1</sub>	V <sub>SW2</sub>
<b>t<sub>AON</sub></b>	RZQ/4 (60Ω)	n/a	50mV	100mV
	RZQ/12 (20Ω)	n/a	100mV	200mV
<b>t<sub>AOFF</sub></b>	RZQ/4 (60Ω)	n/a	50mV	100mV
	RZQ/12 (20Ω)	n/a	100mV	200mV
<b>t<sub>AONPD</sub></b>	RZQ/4 (60Ω)	n/a	50mV	100mV
	RZQ/12 (20Ω)	n/a	100mV	200mV
<b>t<sub>AOFPD</sub></b>	RZQ/4 (60Ω)	n/a	50mV	100mV
	RZQ/12 (20Ω)	n/a	100mV	200mV
<b>t<sub>ADC</sub></b>	RZQ/12 (20Ω)	RZQ/2 (120Ω)	200mV	300mV

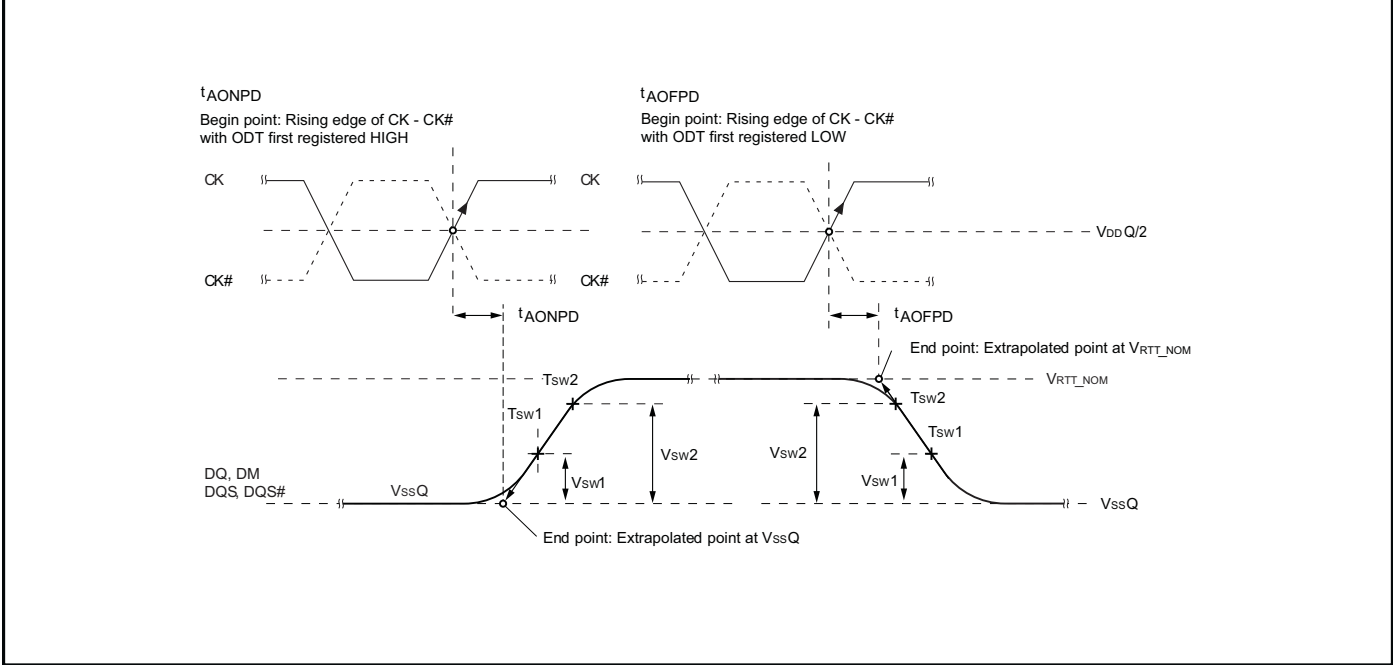
**FIGURE 16 - t<sub>AON</sub> AND t<sub>AOFF</sub> DEFINITIONS**



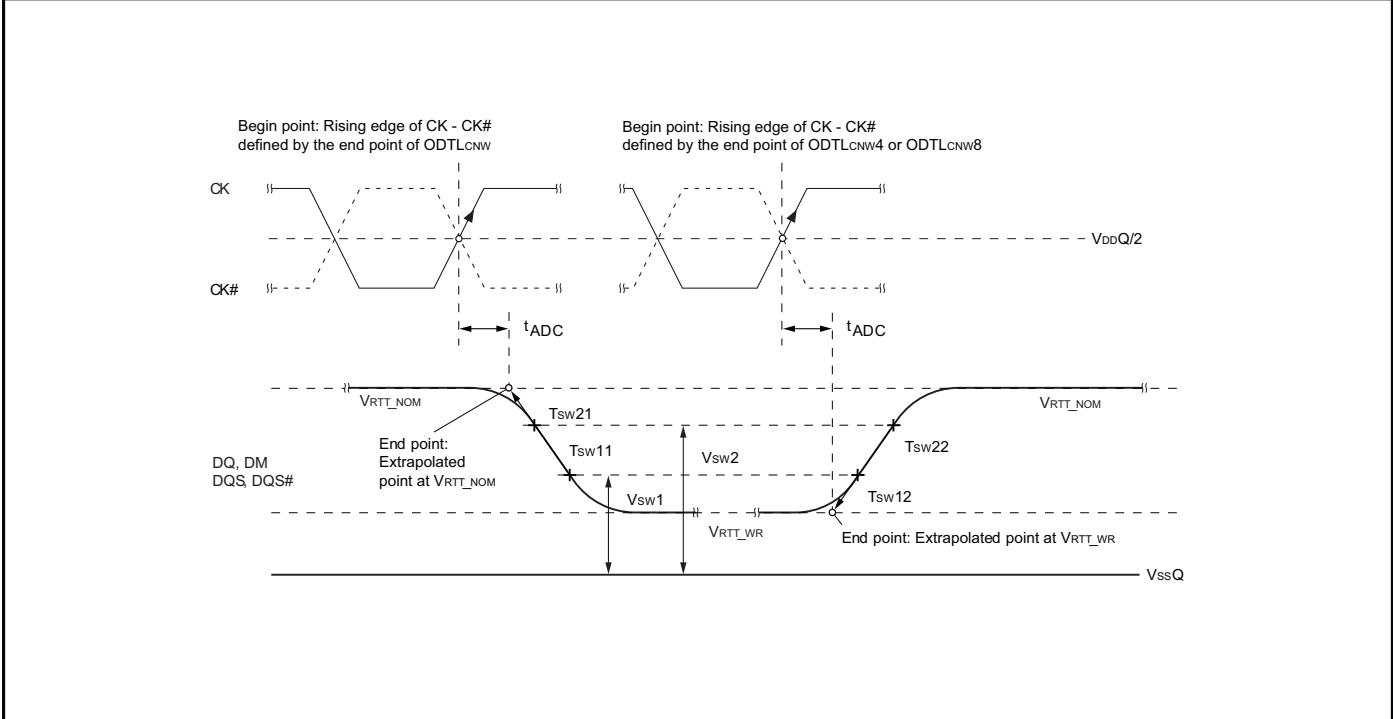


**ODT CHARACTERISTICS**

**FIGURE 17 -  $t_{AONPD}$  AND  $t_{AOFPD}$  DEFINITION**

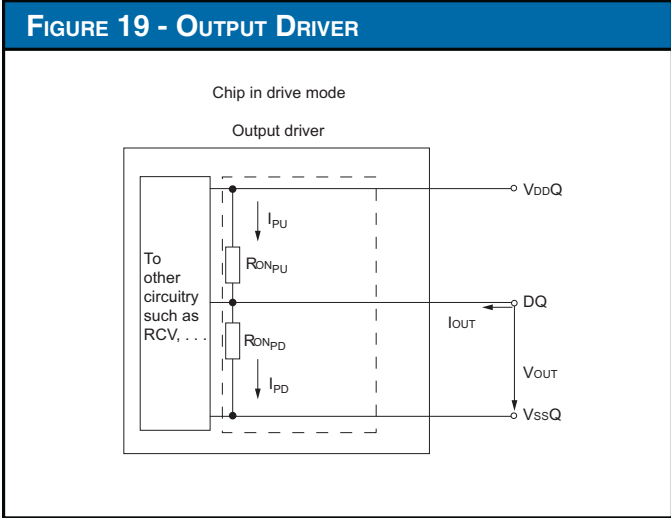


**FIGURE 18 -  $t_{ADC}$  DEFINITION**



**16-32 Gb, DDR3, 256-512M x 32 Dual Channel Memory Module**

**OUTPUT DRIVER IMPEDANCE**



**34 OHM OUTPUT DRIVER IMPEDANCE**

The 34Ω driver (MR1[5,1]=01) is the default driver. Unless otherwise stated, all timings and specifications listed herein apply to the 34Ω driver only. Its impedance RON is defined by the value of the external reference resistor RZQ as follows: RON34=RZQ/7 (with nominal RZQ=240Ω±1%) and is actually 34.3Ω±1%. The 34Ω output driver impedance characteristics are listed in Table 32.

**TABLE 32: 34Ω DRIVER IMPEDANCE CHARACTERISTICS**

MR1[5,1]	RON	RESISTOR	VOUT	MIN	TYP	MAX	UNITS	NOTES
0, 1	34.3Ω	RON34PD	0.2/VDDQ	0.6	1.0	1.1	RZQ/7	1
			0.5/VDDQ	0.9	1.0	1.1	RZQ/7	1
			0.8/VDDQ	0.9	1.0	1.4	RZQ/7	1
		RON34PU	0.2/VDDQ	0.9	1.0	1.4	RZQ/7	1
			0.5/VDDQ	0.9	1.0	1.1	RZQ/7	1
			0.8/VDDQ	0.6	1.0	1.1	RZQ/7	1
<b>Pull-Up/Pull-Down mismatch (MMPUD)</b>			0.5/VDDQ	-10	n/a	10	%	1, 2

NOTES:

1. Tolerance limits assume RZQ of 240Ω (±1%) and are applicable after proper ZQ calibration has been performed at a stable temperature and voltage (VDDQ = VDD, VSSQ = VSS). Refer to "34 Ohm drive sensitivity" if either the temperature or the voltage changes after calibration
2. Measurement definition for mismatch between pull-up and pull-down (MMPUD). Measure both RONPU and RONPD at 0.5 x VDDQ:

$$MMPUD = \frac{RONPU - RONPD}{RONNOM}$$

## 16-32 Gb, DDR3, 256-512M x 32 Dual Channel Memory Module

### 34 Ω<sub>HM</sub> OUTPUT DRIVER IMPEDANCE

#### 34 Ω<sub>HM</sub> DRIVER

The 34Ω driver's current range has been calculated and summarized in Table 34 for V<sub>DD</sub>=1.35V, Table 35 for V<sub>DD</sub>=1.4175V and Table 36 for V<sub>DD</sub>=1.2825V. The individual pull-up and pull-down resistors (RON34PD and RON34PU) are defined as follows with the Impedance Calculations listed in Table 36.

- RON34PD=(VOUT)/[IOUT]: RON34PU is turned off
- RON34PU=(V<sub>DDQ</sub>-VOUT)/[IOUT]: RON34PD is turned off

TABLE 33: 34Ω DRIVER PULL-UP AND PULL-DOWN IMPEDANCE CALCULATIONS							
RON				MIN	TYP	MAX	UNITS
RZQ = 240Ω±1%				237.6	240	242.4	Ω
RZQ = (240Ω±1%)/7				33.9	34.3	34.6	Ω
MR1[5,1]	RON	RESISTOR	VOUT	MIN	TYP	MAX	UNITS
0, 1	34.3Ω	RON34PD	0.2/V <sub>DDQ</sub>	2.04	34.3	38.1	Ω
			0.5/V <sub>DDQ</sub>	30.5	34.3	38.1	Ω
			0.8/V <sub>DDQ</sub>	30.5	34.3	48.5	Ω
		RON34PU	0.2/V <sub>DDQ</sub>	30.5	34.3	48.5	Ω
			0.5/V <sub>DDQ</sub>	30.5	34.3	38.1	Ω
			0.8/V <sub>DDQ</sub>	20.4	34.3	38.1	Ω

TABLE 34: 34Ω DRIVER IOH/IOL CHARACTERISTICS: V <sub>DD</sub> = V <sub>DDQ</sub> = 1.35V							
MR1[5,1]	RON	RESISTOR	VOUT	MIN	TYP	MAX	UNITS
0, 1	34.3Ω	RON34PD	IOL @ 0.2 x V <sub>DDQ</sub>	14.7	8.8	7.9	mA
			IOL @ 0.5 x V <sub>DDQ</sub>	24.6	21.9	19.7	mA
			IOL @ 0.8 x V <sub>DDQ</sub>	39.3	35	24.8	mA
		RON34PU	IOL @ 0.2 x V <sub>DDQ</sub>	39.3	35	24.8	mA
			IOL @ 0.5 x V <sub>DDQ</sub>	24.6	21.9	19.7	mA
			IOL @ 0.8 x V <sub>DDQ</sub>	14.7	8.8	7.9	mA

TABLE 35: 34Ω DRIVER IOH/IOL CHARACTERISTICS: V <sub>DD</sub> =V <sub>DDQ</sub> =1.4175V							
MR1[5,1]	RON	RESISTOR	VOUT	MIN	TYP	MAX	UNITS
0, 1	34.3Ω	RON34PD	IOL @ 0.2 x V <sub>DDQ</sub>	15.5	9.2	8.3	mA
			IOL @ 0.5 x V <sub>DDQ</sub>	25.8	23	20.7	mA
			IOL @ 0.8 x V <sub>DDQ</sub>	41.2	36.8	26	mA
		RON34PU	IOL @ 0.2 x V <sub>DDQ</sub>	41.2	36.8	26	mA
			IOL @ 0.5 x V <sub>DDQ</sub>	25.8	23	20.7	mA
			IOL @ 0.8 x V <sub>DDQ</sub>	15.5	9.2	8.3	mA

## 16-32 Gb, DDR3, 256-512M x 32 Dual Channel Memory Module

### 34 $\Omega$ $O_{HM}$ OUTPUT DRIVER IMPEDANCE

**TABLE 36: 34 $\Omega$  DRIVER IOH/IOL CHARACTERISTICS:  $V_{DD}=V_{DDQ}=1.2825V$**

MR1[5,1]	RON	RESISTOR	VOUT	MIN	TYP	MAX	UNITS
0, 1	34.3 $\Omega$	Ron34PD	IOL @ 0.2 x V <sub>DDQ</sub>	14	8.3	7.5	mA
			IOL @ 0.5 x V <sub>DDQ</sub>	23.3	20.8	18.7	mA
			IOL @ 0.8 x V <sub>DDQ</sub>	37.3	33.3	23.5	mA
		Ron34PU	IOL @ 0.2 x V <sub>DDQ</sub>	37.3	33.3	23.5	mA
			IOL @ 0.5 x V <sub>DDQ</sub>	23.3	20.8	18.7	mA
			IOL @ 0.8 x V <sub>DDQ</sub>	14	8.3	7.5	mA

### 34 $\Omega$ OUTPUT DRIVER SENSITIVITY

If either the temperature or voltage changes after ZQ calibration, the tolerance limits listed in Table 32 can be expected to widen according to Table 37 and 38.

**TABLE 37: 34 $\Omega$  OUTPUT DRIVER SENSITIVITY DEFINITION**

Symbol	MIN	MAX	UNITS
RON @ 0.8 x V <sub>DDQ</sub>	0.9 - dRondTH x [ $\Delta$ T] + dRondVH x [ $\Delta$ V]	1.1 - dRondTH x [ $\Delta$ T] + dRondVH x [ $\Delta$ V]	RZQ/7
RON @ 0.5 x V <sub>DDQ</sub>	0.9 - dRondTM x [ $\Delta$ T] + dRondVM x [ $\Delta$ V]	1.1 - dRondTM x [ $\Delta$ T] + dRondVM x [ $\Delta$ V]	RZQ/7
RON @ 0.2 x V <sub>DDQ</sub>	0.9 - dRondTL x [ $\Delta$ T] + dRondVL x [ $\Delta$ V]	1.1 - dRondTL x [ $\Delta$ T] + dRondVL x [ $\Delta$ V]	RZQ/7

**TABLE 38: 34 $\Omega$  OUTPUT DRIVER VOLTAGE AND TEMPERATURE SENSITIVITY**

Change	MIN	MAX	UNITS
dRondTM	0	1.5	%/°C
dRondVM	0	0.13	%/mV
dRondTL	0	1.5	%/°C
dRondVL	0	0.13	%/mV
dRondTH	0	1.5	%/°C
dRondVH	0	0.13	%/mV

## 16-32 Gb, DDR3, 256-512M x 32 Dual Channel Memory Module

### ALTERNATIVE 40 OHM DRIVER

TABLE 39 - 40Ω DRIVER IMPEDANCE CHARACTERISTICS								
MR1[5,1]	RON	RESISTOR	VOUT	MIN	TYP	MAX	UNITS	NOTES
0, 1	40.0Ω	RON40PD	0.2/VDDQ	0.6	1.0	1.1	RZQ/6	1
			0.5/VDDQ	0.9	1.0	1.1	RZQ/6	1
			0.8/VDDQ	0.9	1.0	1.4	RZQ/6	1
		RON40PU	0.2/VDDQ	0.9	1.0	1.4	RZQ/6	1
			0.5/VDDQ	0.9	1.0	1.1	RZQ/6	1
			0.8/VDDQ	0.6	1.0	1.1	RZQ/6	1
<b>Pull-Up/Pull-Down mismatch (MMPUPD)</b>			0.5/VDDQ	-10	n/a	10	%	1, 2

NOTES:

1. Tolerance limits assume RZQ of 240Ω (±1%) and are applicable after proper ZQ calibration has been performed at a stable temperature and voltage (VDDQ = VDD, VSSQ = VSS). Refer to "40 Ohm drive sensitivity" if either the temperature or the voltage changes after calibration
2. Measurement definition for mismatch between pull-up and pull-down (MMPUPD). Measure both RONPU and RONPD at 0.5 x VDDQ:

$$MMPUPD = \frac{RONPU - RONPD}{RONNOM} \times 100$$

### 40Ω OUTPUT DRIVER SENSITIVITY

If either the temperature or voltage changes after I/O calibration, the tolerance limits listed in Table 39 can be expected to widen according to Table 40 and 41.

TABLE 40: 40Ω OUTPUT DRIVER SENSITIVITY DEFINITION			
Symbol	MIN	MAX	UNITS
<b>RON @ 0.8 x VDDQ</b>	0.9 - dRondTH x [ΔT] + dRondVH x [ΔV]	1.1 - dRondTH x [ΔT] + dRondVH x [ΔV]	RZQ/6
<b>RON @ 0.5 x VDDQ</b>	0.9 - dRondTM x [ΔT] + dRondVM x [ΔV]	1.1 - dRondTM x [ΔT] + dRondVM x [ΔV]	RZQ/6
<b>RON @ 0.2 x VDDQ</b>	0.9 - dRondTL x [ΔT] + dRondVL x [ΔV]	1.1 - dRondTL x [ΔT] + dRondVL x [ΔV]	RZQ/6

## 16-32 Gb, DDR3, 256-512M x 32 Dual Channel Memory Module

### ALTERNATIVE 40 OHM DRIVER

**TABLE 41: 40Ω OUTPUT DRIVER VOLTAGE AND TEMPERATURE SENSITIVITY**

Change	MIN	MAX	UNITS
dRondTM	0	1.5	%/°C
dRondVM	0	0.15	%/mV
dRondTL	0	1.5	%/°C
dRondVL	0	0.15	%/mV
dRondTH	0	1.5	%/°C
dRondVH	0	0.15	%/mV

### OUTPUT CHARACTERISTICS AND OPERATING CONDITIONS

The SDRAM uses both single-ended and differential output drivers. The single-ended output driver is summarized in Table 42 while the differential output driver is summarized in Table 43.

**TABLE 42: SINGLE-ENDED OUTPUT DRIVER CHARACTERISTICS**

Parameter/Condition	Symbol	MIN	MAX	UNITS	NOTES
<b>Output leakage current:</b> DQ are disabled; $0V \leq V_{OUT} \leq V_{DDQ}$ ; ODT is disabled; ODT is HIGH	Ioz	-5	5	uA	1
<b>Output slew rate:</b> Single-ended; for rising and falling edges, measure between $V_{OL(AC)} = V_{REF} - 0.1 \times V_{DDQ}$ and $V_{OH(AC)} = V_{REF} + 0.1 \times V_{DDQ}$	SRQSE	2.5	6	V/ns	1, 2, 3, 4
<b>Single-ended DC high-level output voltage</b>	VOH(DC)	$0.8 \times V_{DDQ}$		V	1, 2, 5
<b>Single-ended DC mid-point level output voltage</b>	VOM(DC)	$0.5 \times V_{DDQ}$		V	1, 2, 5
<b>Single-ended DC low-point level output voltage</b>	VOL(DC)	$0.2 \times V_{DDQ}$		V	1, 2, 5
<b>Single-ended DC high-point level output voltage</b>	VOH(AC)	$V_{TT} + 0.1 \times V_{DDQ}$		V	1, 2, 3, 6
<b>Single-ended DC low-point level output voltage</b>	VOL(AC)	$V_{TT} - 0.1 \times V_{DDQ}$		V	1, 2, 3, 6
<b>Delta RON between pull-up and pull-down for DQ/DQS</b>	MMPUPD	-10	10	%	1, 7
<b>Test load for AC timing and output slew rates</b>	Output to $V_{TT}$ ( $V_{DDQ}/2$ ) via 25Ω resistor				3

NOTES:

1. RZQ of 240Ω (±1%) with RZQ/7 enabled (default 34Ω driver) and is applicable after proper ZQ calibration has been performed at a stable temperature and voltage ( $V_{DDQ} = V_{DD}$ ,  $V_{SSQ} = V_{SS}$ ).
2.  $V_{TT} = V_{DDQ}/2$
3. See Figure 31 on page 69 for the test load configuration.
4. The 6V/ns maximum is applicable for a single DQ signal when it is switching from either HIGH to LOW or LOW to HIGH while the remaining DQ signals in the same byte lane are combinations, the maximum limit of 6V/ns maximum is reduced to 5V/ns.
5. See Table 32 on page 41 IV curve linearity. Do not use AC Test load.
6. See Table 44 on page 48 for output slew rate.
7. See Table 32 on page 41 for additional information.
8. See Figure 29 on page 67 for an example of a single-ended output signal.

## 16-32 Gb, DDR3, 256-512M x 32 Dual Channel Memory Module

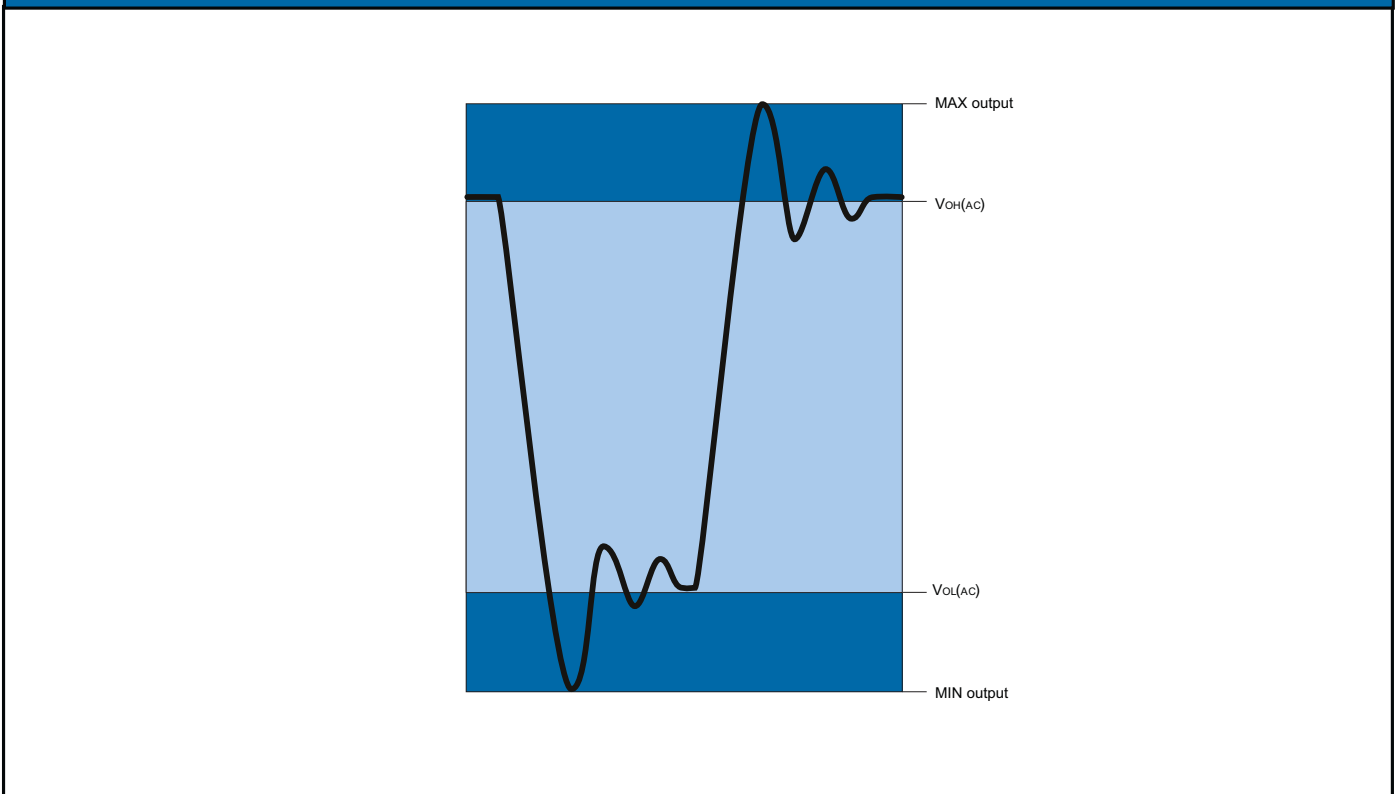
**TABLE 43: DIFFERENTIAL OUTPUT DRIVER CHARACTERISTICS**

Parameter/Condition	Symbol	MIN	MAX	UNITS	NOTES
<b>Output leakage current:</b> DQ are disabled; $0V \leq V_{OUT} \leq V_{DDQ}$ ; ODT is HIGH	IOZ	-5	5	uA	1
<b>Output slew rate:</b> Differential; for rising and falling edges, measure between $V_{OLDIFF}(AC) = -0.2 \times V_{DDQ}$ and $V_{OH}(AC) = +0.2 \times V_{DDQ}$	SRQDIFF	5	12	V/ns	1
<b>Output differential cross-point voltage</b>	$V_{OX}(AC)$	$V_{REF}-150$	$V_{REF}+150$	mV	1, 2, 3
<b>Differential high-level output voltage</b>	$V_{OHDIFF}(AC)$	$+0.2 \times V_{DDQ}$		V	1, 4
<b>Differential low-level output voltage</b>	$V_{OLDIFF}(AC)$	$-0.2 \times V_{DDQ}$		V	1, 4
<b>Delta RON between pull-up and pull-down for DQ/DQS</b>	MMPUPD	-10	10	%	1, 5
<b>Test load for AC timing and output slew rates</b>	Output to $V_{TT}$ ( $V_{DDQ}/2$ ) via $25\Omega$ resistor				3

NOTES:

1. RZQ of  $240\Omega$  ( $\pm 1\%$ ) with RZQ/7 enabled (default  $34\Omega$  driver) and is applicable after proper ZQ calibration has been performed at a stable temperature and voltage ( $V_{DDQ} = V_{DD}$ ,  $V_{SSQ} = V_{SS}$ ).
2.  $V_{REF} = V_{DDQ}/2$
3. See Figure 31 on page 69 for the test load configuration.
4. See Table 47 on page 49 for the output slew rate.
5. See Table 32 on page 59 for additional information.
6. See Figure 30 on page 68 for an example of a differential output signal.

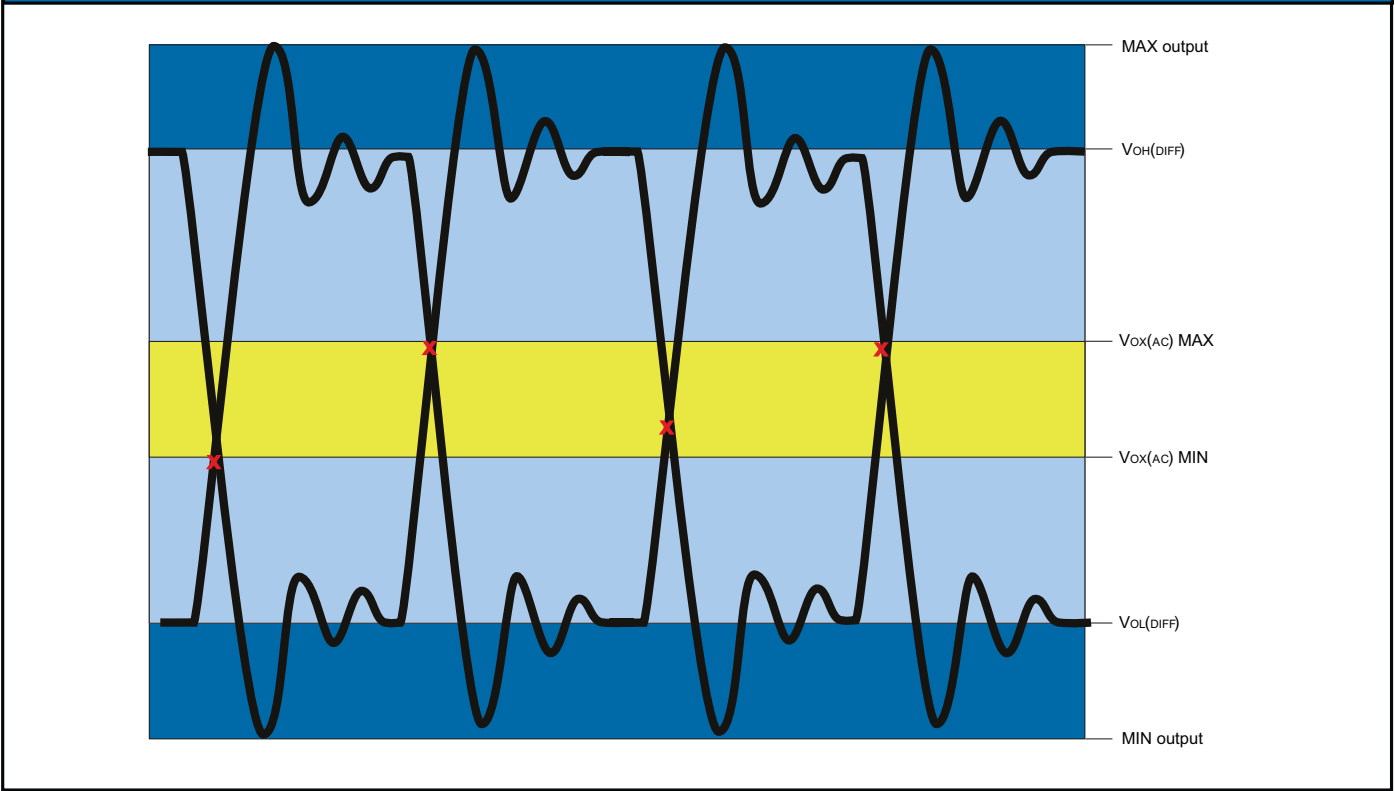
**FIGURE 20 - DQ OUTPUT SIGNAL**



16-32 Gb, DDR3, 256-512M x 32 Dual Channel Memory Module

**OUTPUT CHARACTERISTICS AND OPERATING CONDITIONS**

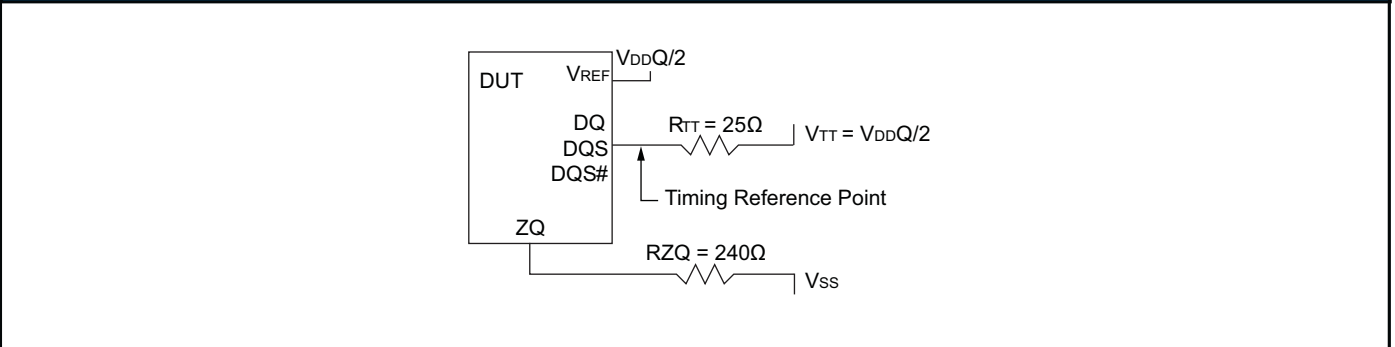
**FIGURE 21 - DIFFERENTIAL OUTPUT SIGNAL**



**REFERENCE OUTPUT LOAD**

Figure 22 represents the effective reference load of  $25\Omega$  used in defining the relevant device AC timing parameters (except ODT reference timing) as well as the output slew rate measurements. It is not intended to be a precise representation of a particular system environment or a depiction of the actual load presented by any specific industry test system/apparatus. System designers should use IBIS or other simulation tools to correlate the timing reference load presented or exhibited on the system or system environment.

**FIGURE 22 - REFERENCE OUTPUT LOAD FOR AC TIMING AND OUTPUT SLEW RATE**





**16-32 Gb, DDR3, 256-512M x 32 Dual Channel Memory Module**

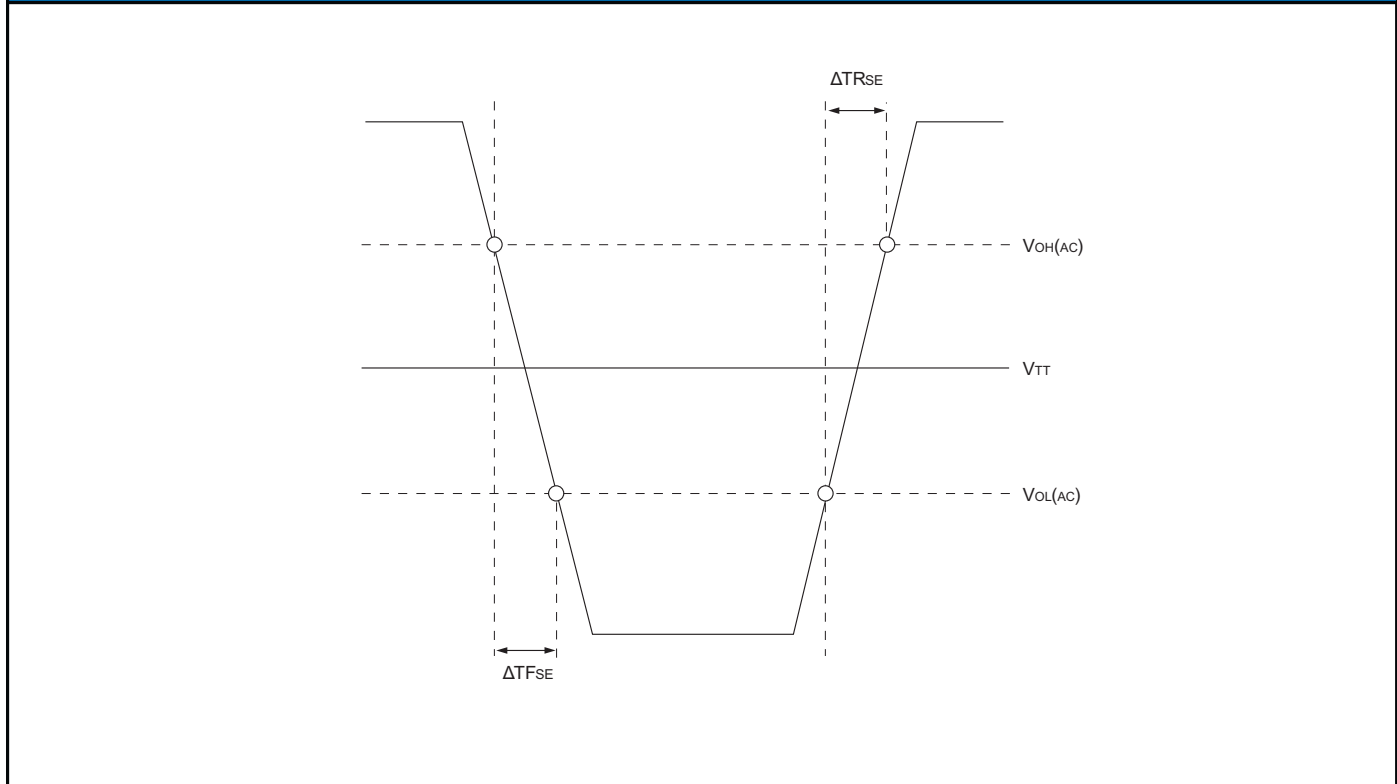
**SLEW RATE DEFINITIONS FOR SINGLE-ENDED OUTPUT SIGNALS**

The single-ended output driver is summarized in Table 42. With the reference load for timing measurements, the output slew-rate for falling and rising edges is defined and measured between  $V_{OL(AC)}$  and  $V_{OH(AC)}$  for single-ended signals as indicated in Table 44 and Figure 23.

**TABLE 44: SINGLE-ENDED OUTPUT SLEW RATE**

Output Slew Rate (Linear Signals)		Measured		Calculation
Output	Edge	From	To	
DQ	Rising	$V_{OL(AC)}$	$V_{OH(AC)}$	$\frac{V_{OH(AC)} - V_{OL(AC)}}{\Delta TRSE}$
	Falling	$V_{OH(AC)}$	$V_{OL(AC)}$	$\frac{V_{OH(AC)} - V_{OL(AC)}}{\Delta TFSE}$

**FIGURE 23 - NOMINAL SLEW RATE DEFINITION FOR SINGLE-ENDED OUTPUT SIGNALS**



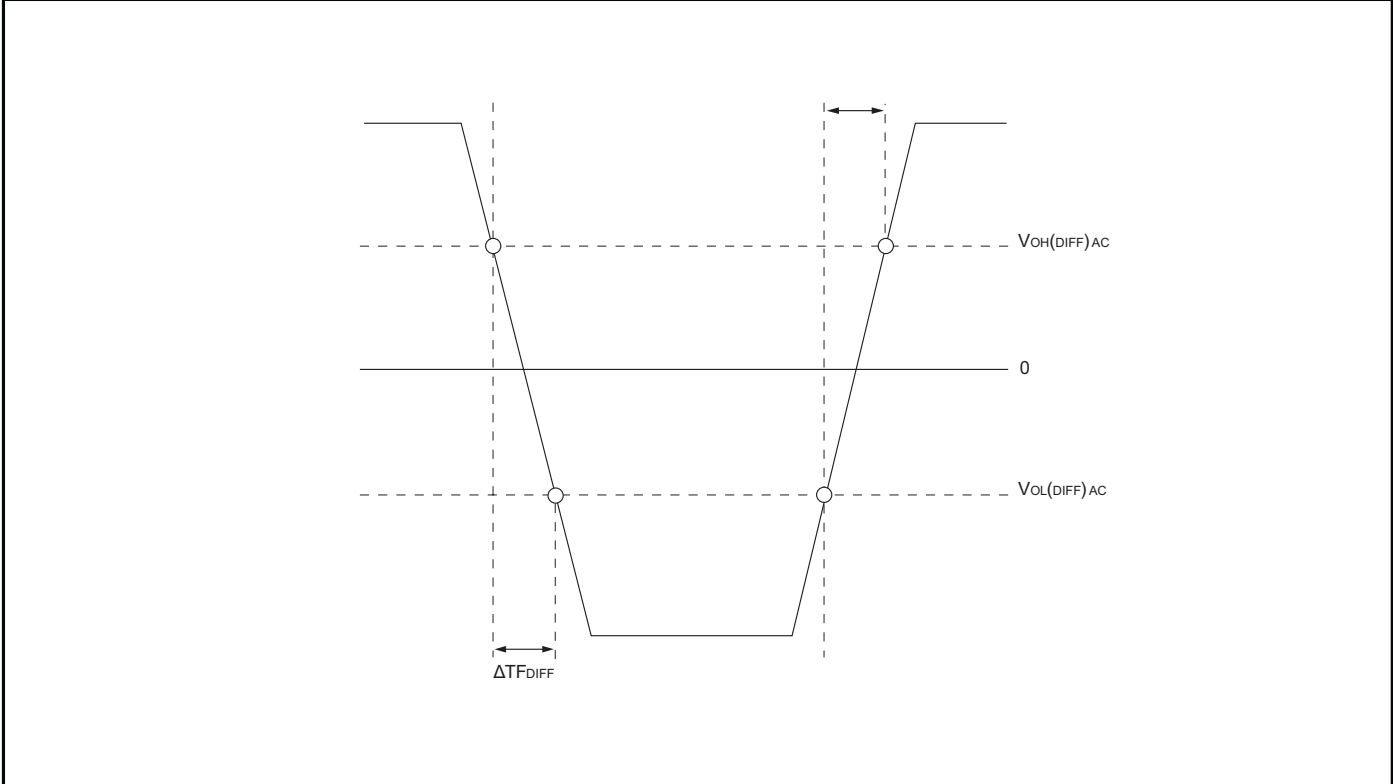
**16-32 Gb, DDR3, 256-512M x 32 Dual Channel Memory Module**

**SLEW RATE DEFINITIONS FOR DIFFERENTIAL OUTPUT SIGNALS**

The differential output driver is summarized in Table 43. With the reference load for timing measurements, the output slew rate for falling and rising edges is defined and measured between VOL(AC) and VOH(AC) for differential signals, as shown in Table 45 and Figure 33.

TABLE 45: DIFFERENTIAL OUTPUT SLEW RATE DEFINITION				
Output Slew Rate (Linear Signals)		Measured		Calculation
Output	Edge	From	To	
DQS, DQS\	Rising	VoLDIFF(AC)	VoHDIFF(AC)	$\frac{VoHDIFF(AC) - VoLDIFF(AC)}{\Delta TRDIFF}$
	Falling	VoHDIFF(AC)	VoLDIFF(AC)	$\frac{VoHDIFF(AC) - VoLDIFF(AC)}{\Delta TFDIFF}$

**FIGURE 24 - NOMINAL DIFFERENTIAL OUTPUT SLEW RATE DEFINITION FOR DQS, DQS#**



## 16-32 Gb, DDR3, 256-512M x 32 Dual Channel Memory Module

**TABLE 46: SPEED BINS**

		-15 (DDR3-1333) [CWL=1.5; 10-10-10]		-12 (DDR3-1600) [CWL=1.25; 11-11-11]		-11 (DDR3-1866) [CWL=1.07; 13-13-13]				
Parameter	Symbol	MIN	MAX	MIN	MAX	MIN	MAX	UNITS	NOTES	
ACTIVATE to internal READ or WRITE delay time	$t_{RCD}$	15	-	13.75	-	13.91	-	ns		
PRECHARGE command period	$t_{RP}$	15	-	13.75	-	13.91	-	ns		
ACTIVATE-to-ACTIVATE or REFRESH command period	$t_{RC}$	51	-	48.75	-	48.91	-	ns		
ACTIVATE-to-PRECHARGE command period	$t_{RAS}$	36	$9 \times t_{REFI}$	35	$9 \times t_{REFI}$	34	$9 \times t_{REFI}$	ns	1	
CL=5	CWL=5	$t_{CK}$ (AVG)	3	3.3	3	3.3	3	3	ns	2
	CWL=6	$t_{CK}$ (AVG)							ns	3
	CWL=7	$t_{CK}$ (AVG)							ns	3
CL=6	CWL=5	$t_{CK}$ (AVG)	2.5	3.3	2.5	3.3	2.5	3.3	ns	2
	CWL=6	$t_{CK}$ (AVG)							ns	3
	CWL=7	$t_{CK}$ (AVG)							ns	3
CL=8	CWL=5	$t_{CK}$ (AVG)							ns	3
	CWL=6	$t_{CK}$ (AVG)	1.875	<2.5	1.875	<2.5	1.875	<2.5	ns	2,3
	CWL=7	$t_{CK}$ (AVG)							ns	3
CL=10	CWL=5	$t_{CK}$ (AVG)							ns	3
	CWL=6	$t_{CK}$ (AVG)							ns	3
	CWL=7	$t_{CK}$ (AVG)	1.5	<1.875	1.5	<1.875	1.5	1.875	ns	2,3
Supported CL Settings			5, 6, 8, 10		5, 6, 8, 10		5, 6, 8, 10, 11, 13		CK	
Supported CWL Settings			5, 6, 7		5, 6, 7		5, 6, 7, 8, 9		CK	

NOTES:

- $t_{REFI}$  depends on  $t_{OPER}$
- The CL and CWL setting result in  $t_{CK}$  requirements. When making a selection of  $t_{CK}$ , both CL and CWL requirement settings need to be fulfilled.
- Reserved (filled blocks) settings are not allowed.

16-32 Gb, DDR3, 256-512M x 32 Dual Channel Memory Module

**TABLE 47 (SHEET 1 OF 6) - ELECTRICAL CHARACTERISTICS AND AC OPERATING CONDITIONS**

Parameter	Symbol	-15 (DDR3-1333) [CWL=1.5; 10-10-10]		-12 (DDR3-1600) [CWL=1.25; 11-11-11] [CWL=1.07; 13-13-13]		Units	Notes	
		MIN	MAX	MIN	MAX			
Clock period average: DLL disable mode TC = 0°C to <85°C TC = 85°C to 105°C TC = >105°C to ≤125°C	'CKDLL_DIS	8	7800	8	7800	ns	9,42	
		8	3900	8	3900			
		8	2900	-	-			
See SPEED BIN TABLE (#49) for tCK range allowed								
Clock period average: DLL enable mode	'tCK (AVG)	ns						10,11
HIGH pulse width average	'tCH (AVG)	0.47	0.53	0.47	0.53	CK	12	
LOW pulse width average	'tCL (AVG)	0.47	0.53	0.47	0.53	CK	12	
Clock period JITTER	'tJTPER	-80	80	-70	70	ps	13	
	'tJTPER, LCK	-70	70	-60	60	ps	13	
Clock absolute period	'tCLK (ABS)	MIN=tCK (AVG) MIN+tJTPER MIN; MAX=tCK (AVG) MAX+tJTPER MAX						ps
Clock absolute HIGH pulse width	'tCH (ABS)	0.43	-	0.43	-	tCK (AVG)	14	
Clock absolute LOW pulse width	'tCL (ABS)	0.43	-	0.43	-	tCK (AVG)	15	
Cycle-to-Cycle JITTER	'tJITCC	160	160	140	120	ps	16	
	'tJITCC, LCK	140	140	120	100	ps	16	
Cumulative error across	'tERR2PERR	-118	118	-103	103	ps	17	
	'tERR3PERR	-140	140	-122	122	ps	17	
	'tERR4PERR	-155	155	-136	136	ps	17	
	'tERR5PERR	-168	168	-147	147	ps	17	
	'tERR6PERR	-177	177	-155	155	ps	17	
	'tERR7PERR	-186	186	-163	163	ps	17	
	'tERR8PERR	-193	193	-169	169	ps	17	
	'tERR9PERR	-200	200	-175	175	ps	17	
	'tERR10PERR	-205	205	-180	180	ps	17	
	'tERR11PERR	-210	210	-184	184	ps	17	
	'tERR12PERR	-215	215	-188	188	ps	17	
	n = 13, 14 ... 49, 50 Cycles		'tERRnPER MIN = (1+0.68ln(n)) x tJTPER MIN				ps	
		'tERRnPER MAX = (1+0.68ln(n)) x tJTPER MAX						

16-32 Gb, DDR3, 256-512M x 32 Dual Channel Memory Module

**TABLE 47 (SHEET 2 OF 6) - ELECTRICAL CHARACTERISTICS AND AC OPERATING CONDITIONS**

Parameter	Symbol	-1.5 (DDR3-1333)		-1.2 (DDR3-1600)		-1.1 (DDR3-1866)		Units	Notes
		MIN	MAX	MIN	MAX	MIN	MAX		
<b>DQ Input Timing</b>									
Data SETUP time to DQS, DQS\	<sup>t</sup> DS AC175	-	-	-	-	-	-	ps	18,19
	Base (specification) VREF @ 1V/ns	-	-	-	-	-	-	ps	19,20
Data SETUP time to DQS, DQS\	<sup>t</sup> DS AC150	30	-	10	-	-	-	ps	18,19
	Base (specification) VREF @ 1V/ns	180	-	160	-	135	-	ps	19,20
Data HOLD time from DQS, DQS\	<sup>t</sup> DH AC100	65	-	45	-	20	-	ps	18,19
	Base (specification) VREF @ 1V/ns	165	-	145	-	120	-	ps	19,20
Minimum Data Pulse Width	<sup>t</sup> DIPW	400	-	360	-	320	-	ps	41
<b>DQ Output Timing</b>									
DQS, DQS\ to DQ SKEW, per access	<sup>t</sup> DQSQ	-	125	-	100	-	85	ps	
DQ Output HOLD time from DQS, DQS\	<sup>t</sup> QH	0.38	-	0.38	-	0.38	-	tCK (AVG)	21
DQ LOW-Z time from CK, CK\	<sup>t</sup> LZ (DQ)	-500	250	-450	225	-390	195	ps	22,23
DQ HIGH-A time from CK, CK\	<sup>t</sup> HZ (DQ)	-	250	-	225	-	195	ps	22,23
<b>DQ Strobe Input Timing</b>									
DQS, DQS\ RISING to CK, CK\ RISING	<sup>t</sup> DQSS	-0.25	0.25	-0.27	0.27	-0.27	0.27	CK	25
DQS, DQS\ DIFFERENTIAL Input Low pulse width	<sup>t</sup> DQSL	0.45	0.55	0.45	0.55	0.45	0.55	CK	
DQS, DQS\ DIFFERENTIAL Input HIGH pulse width	<sup>t</sup> DQSH	0.45	0.55	0.45	0.55	0.45	0.55	CK	
DQS, DQS\ FALLING Setup to CK, CK\ RISING	<sup>t</sup> DSS	0.2	-	0.18	-	0.18	-	CK	25
DQS, DQS\ FALLING Hold from CK, CK\ RISING	<sup>t</sup> DSH	0.2	-	0.18	-	0.18	-	CK	25
DQS, DQS\ DIFFERENTIAL WRITE preamble	<sup>t</sup> WPPE	0.9	-	0.9	-	0.9	-	CK	
DQS, DQS\ DIFFERENTIAL WRITE postamble	<sup>t</sup> WPST	0.3	-	0.3	-	0.3	-	CK	
<b>DQ Strobe Output Timing</b>									
DQS, DQS\ RISING to/from RISING CK, CK\	<sup>t</sup> DQSK	-255	255	-225	225	-195	195	ps	23
DQS, DQS\ RISING to/from RISING CK, CK\ when DLL is disabled	<sup>t</sup> DQSK DLL_DIS	1	10	1	10	1	10	ns	26
DQS, DQS\ DIFFERENTIAL Output HIGH time	<sup>t</sup> QSH	0.4	-	0.4	-	0.4	-	CK	21
DQS, DQS\ DIFFERENTIAL Output LOW time	<sup>t</sup> QSL	0.4	-	0.4	-	0.4	-	CK	21
DQS, DQS\ LOW-Z time (RL-1)	<sup>t</sup> LZ (DQS)	-500	250	-450	225	-390	195	ps	22,23
DQS, DQS\ HIGH-Z time (RL+BL/2)	<sup>t</sup> HZ (DQS)	-	250	-	225	-	195	ps	22,23
DQS, DQS\ DIFFERENTIAL READ preamble	<sup>t</sup> RPPE	0.9	Note 24	0.9	Note 24	0.9	Note 24	CK	23,24
DQS, DQS\ DIFFERENTIAL READ postamble	<sup>t</sup> RPST	0.3	Note 27	0.3	Note 27	0.3	Note 27	CK	23,27

## 16-32 Gb, DDR3, 256-512M x 32 Dual Channel Memory Module

**TABLE 47 (SHEET 3 OF 6) - ELECTRICAL CHARACTERISTICS AND AC OPERATING CONDITIONS**

Parameter	Symbol	-15 (DDR3-1333) [CWL=1.5; 10-10-10]				-12 (DDR3-1600) [CWL=1.25; 11-11-11]				-11 (DDR3-1866) [CWL=1.07; 13-13-13]				Units	Notes	
		MIN	MAX	MIN	MAX	MIN	MAX	MIN	MAX							
<b>Command and Address Timing</b>																
DLL Locking time	<sup>t</sup> DLK	512	-	512	-	512	-	512	-	512	-	512	-	CK	28	
CTRL, CMD, ADDR setup to CK, CK\	<sup>t</sup> S AC175	Base (specification)	-	45	-	45	-	65	-	65	-	200	-	ps	29,30	
		VREF @ 1V/ns	240	-	220	-	200	-	200	-	200	-	200	-	ps	20,30
CTRL, CMD, ADDR setup to CK, CK\	<sup>t</sup> S AC150	Base (specification)	190	-	170	-	170	-	150	-	150	-	175	-	ps	29,30
		VREF @ 1V/ns	340	-	320	-	275	-	275	-	275	-	275	-	ps	20,30
CTRL, CMD, ADDR hold to CK, CK\	<sup>t</sup> H DC100	Base (specification)	140	-	120	-	100	-	100	-	100	-	200	-	ps	29,30
		VREF @ 1V/ns	240	-	220	-	200	-	200	-	200	-	200	-	ps	20,30
Minimum CTRL, CMD, ADDR pulse width	<sup>t</sup> IPW	620	-	560	-	535	-	-	-	-	-	-	-	ps	41	
ACTIVATE to Internal READ or WRITE delay	<sup>t</sup> RCD	See "Speed Bin Table (#49) for tRCD														
PRECHARGE command period	<sup>t</sup> RP	See "Speed Bin Table (#49) for tRP														
ACTIVATE-to-PRECHARGE command period	<sup>t</sup> RAS	See "Speed Bin Table (#49) for tRAS														
ACTIVATE-to-ACTIVATE command period	<sup>t</sup> RCD	See "Speed Bin Table (#49) for tRC														
ACTIVATE-to-ACTIVATE minimum command period	<sup>t</sup> RRD	1KB page size	MIN=greater of 4CK or 6ns		MIN=greater of 4CK or 6ns		MIN=greater of 4CK or 5ns		MIN=greater of 4CK or 5ns		MIN=greater of 4CK or 6ns		MIN=greater of 4CK or 6ns		CK	31
		2KB page size	MIN=greater of 4CK or 7.5ns		MIN=greater of 4CK or 7.5ns		MIN=greater of 4CK or 6ns		MIN=greater of 4CK or 6ns		MIN=greater of 4CK or 6ns		MIN=greater of 4CK or 6ns		CK	31
Four ACTIVATE windows for 1KB page size	<sup>t</sup> FAW	30	-	30	-	25	-	25	-	25	-	25	-	ns	31	
Four ACTIVATE windows for 2KB page size	<sup>t</sup> FAW	45	-	40	-	35	-	35	-	35	-	35	-	ns	31	
WRITE recovery time	<sup>t</sup> WR	MIN = 15ns; MAX = n/a														
Delay from start of internal WRITE transaction to internal READ command	<sup>t</sup> WTR	MIN = greater of 4CK or 7.5ns; MAX = n/a														
READ-to-PRECHARGE time	<sup>t</sup> RTP	MIN = greater of 4CK or 7.5ns; MAX = n/a														
CAS\ to-CAS\ command delay	<sup>t</sup> CCD	MIN = 4CK; MAX = n/a														
Auto precharge WRITE recovery + PRECHARGE time	<sup>t</sup> DAL	MIN = WR + <sup>t</sup> RP / CK (AVG); MAX = n/a														
MODE REGISTER SET command cycle time	<sup>t</sup> MRD	MIN = 4CK; MAX = n/a														
MODE REGISTER SET command update delay	<sup>t</sup> MOD	MIN = greater of 12CK or 15ns; MAX = n/a														
MULTIPURPOSE REGISTER READ burst end to mode register set for multipurpose register exit	<sup>t</sup> MPRR	MIN = 1CK; MAX = n/a														

16-32 Gb, DDR3, 256-512M x 32 Dual Channel Memory Module

**TABLE 47 (SHEET 4 OF 6) - ELECTRICAL CHARACTERISTICS AND AC OPERATING CONDITIONS**

Parameter	Symbol	-15 (DDR3-1333)			-12 (DDR3-1600)			-11 (DDR3-1866)			Units	Notes	
		MIN	MAX		MIN	MAX		MIN	MAX				
<b>Calibration Timing</b>													
ZQCL command: Long Calibration time	<sup>t</sup> ZQINIT	512	-	512	-	512	-	512	-	CK			
ZQCS command: Short Calibration Time	<sup>t</sup> ZQOPER	256	-	256	-	256	-	256	-	CK			
	<sup>t</sup> ZQCS	64	-	64	-	64	-	64	-	CK			
<b>Initialization and RESET Timing</b>													
Exit RESET from CKE HIGH to a valid command	<sup>t</sup> XPR	MIN = greater of 5CK or tRFC + 10ns; MAX = n/a										CK	
Begin power supply ramp to power supplies stable	<sup>t</sup> VDDPR	MIN = n/a; MAX = 200										ms	
RESET <sup>t</sup> LOW to power supplies stable	<sup>t</sup> RPS	MIN = 0; MAX = 200										ms	
RESET <sup>t</sup> LOW to I/O and RTT HIGH-Z	<sup>t</sup> IOZ	MIN = n/a; MAX = 20										ns	35
<b>REFRESH Timing</b>													
REFRESH-to-ACTIVATE or REFRESH command period	<sup>t</sup> RFC - 1Gb	MIN = 110; MAX = 70,200										ns	
	<sup>t</sup> RFC - 2Gb	MIN = 160; MAX = 70,200										ns	
	<sup>t</sup> RFC - 4Gb	MIN = 260; MAX = 70,200										ns	
Maximum REFRESH period	-	64 (1X)										ms	36
		32 (2X)										ms	36
		24										ms	36
Maximum REFRESH period/interval	<sup>t</sup> REFI	7.8										µs	36
		3.9										µs	36
		2.9										µs	36
<b>SELF REFRESH Timing</b>													
Exit SELF REFRESH TO commands not requiring a locked DLL	<sup>t</sup> XS	MIN = greater of 5CK or <sup>t</sup> RFC + 10ns; MAX = n/a										CK	
Exit SELF REFRESH TO commands requiring a locked DLL	<sup>t</sup> XSDLL	MIN = <sup>t</sup> DLLK (MIN); MAX = n/a										CK	28
MINIMUM CKE LOW pulse width for SELF REFRESH entry to SELF REFRESH exit timing	<sup>t</sup> CKESR	MIN = <sup>t</sup> CKE (MIN) + CK; MAX = n/a										CK	
Valid clocks after SELF REFRESH entry or POWER-DOWN entry	<sup>t</sup> CKSRE	MIN = greater of 5CK or 10ns; MAX = n/a										CK	
Valid clocks before SELF REFRESH exit, or RESET exit	<sup>t</sup> CKSRX	MIN = greater of 5CK or 10ns; MAX = n/a										CK	

16-32 Gb, DDR3, 256-512M x 32 Dual Channel Memory Module

TABLE 47 (SHEET 5 OF 6) - ELECTRICAL CHARACTERISTICS AND AC OPERATING CONDITIONS

Parameter	Symbol	-15 (DDR3-1333) [CWL=1.5; 10-10-10]		-12 (DDR3-1600) [CWL=1.25; 11-11-11]		-11 (DDR3-1866) [CWL=1.07; 13-13-13]		Units	Notes
		MIN	MAX	MIN	MAX	MIN	MAX		
<b>POWER-DOWN Timing</b>									
CKE MIN pulse width	t <sub>CKE</sub> (MIN)	Greater of 3CK or 5.625ns		Greater of 3CK or 5ns		Greater of 3CK or 5ns		CK	
Command pass disable delay	t <sub>CPDED</sub>	MIN = 1; MAX = n/a		MIN = 1; MAX = n/a		MIN = 1; MAX = n/a		CK	
POWER-DOWN entry to POWER-DOWN exit timing	t <sub>PD</sub>	MIN = t <sub>CKE</sub> (MIN); MAX = 60ms		MIN = t <sub>CKE</sub> (MIN); MAX = 60ms		MIN = t <sub>CKE</sub> (MIN); MAX = 60ms		CK	
Begin POWER-DOWN period prior to CKE registered HIGH	t <sub>ANPD</sub>	WL - 1CK		WL - 1CK		WL - 1CK		CK	
POWER-DOWN entry period: ODT either synchronous or asynchronous	PDE	Greater of t <sub>ANPD</sub> or t <sub>RFC</sub> - REFRESH command to CKE LOW time		Greater of t <sub>ANPD</sub> or t <sub>RFC</sub> - REFRESH command to CKE LOW time		Greater of t <sub>ANPD</sub> or t <sub>RFC</sub> - REFRESH command to CKE LOW time		CK	
POWER-DOWN exit period: ODT either synchronous or asynchronous	PDX	t <sub>ANPD</sub> + t <sub>XPDLL</sub>		t <sub>ANPD</sub> + t <sub>XPDLL</sub>		t <sub>ANPD</sub> + t <sub>XPDLL</sub>		CK	
<b>POWER-DOWN Entry MINIMUM Timing</b>									
ACTIVATE command to POWER-DOWN entry	t <sub>ACTPDEN</sub>	MIN = 1		MIN = 1		MIN = 2		CK	
PRECHARGE/PRECHARGE ALL command to POWER-DOWN entry	t <sub>PRPDEN</sub>	MIN = 1		MIN = 1		MIN = 2		CK	
REFRESH command to POWER-DOWN entry	t <sub>REPDEN</sub>	MIN = 1		MIN = 1		MIN = 2		CK	37
MRS command to POWER-DOWN entry	t <sub>MRS PDEN</sub>	MIN = t <sub>MOD</sub> (MIN)		MIN = t <sub>MOD</sub> (MIN)		MIN = t <sub>MOD</sub> (MIN)		CK	
READ/READ with AUTO PRECHARGE command to POWER-DOWN entry	t <sub>RDPDEN</sub>	MIN = RL + 4 + 1		MIN = RL + 4 + 1		MIN = RL + 4 + 1		CK	
WRITE Command to POWER-DOWN entry	BL8 (OTF, MRS) BC4OTF BC4MRS	MIN = WL + 4 + t <sub>WR</sub> /CK (AVG)		MIN = WL + 4 + t <sub>WR</sub> /CK (AVG)		MIN = WL + 4 + t <sub>WR</sub> /CK (AVG)		CK	
		MIN = WL + 2 + t <sub>WR</sub> /CK (AVG)		MIN = WL + 2 + t <sub>WR</sub> /CK (AVG)		MIN = WL + 2 + t <sub>WR</sub> /CK (AVG)		CK	
WRITE with AUTO PRECHARGE command to POWER-DOWN entry	BL8 (OTF, MRS) BC4OTF BC4MRS	MIN = WL + 4 + WR + 1		MIN = WL + 4 + WR + 1		MIN = WL + 4 + WR + 1		CK	
		MIN = WL + 2 + WR + 1		MIN = WL + 2 + WR + 1		MIN = WL + 2 + WR + 1		CK	
<b>POWER-DOWN Exit Timing</b>									
DLL on, any valid command, or DLL off to commands not requiring DLL locked	t <sub>XP</sub>	MIN = Greater of 3CK or 6.0ns; MAX = n/a		MIN = Greater of 3CK or 6.0ns; MAX = n/a		MIN = Greater of 3CK or 6.0ns; MAX = n/a		CK	
PRECHARGE POWER-DOWN with DLL off to command requiring DLL locked	t <sub>XPDLL</sub>	MIN = Greater of 10CK or 24ns; MAX = n/a		MIN = Greater of 10CK or 24ns; MAX = n/a		MIN = Greater of 10CK or 24ns; MAX = n/a		CK	28



16-32 Gb, DDR3, 256-512M x 32 Dual Channel Memory Module

TABLE 47 (SHEET 6 OF 6) - ELECTRICAL CHARACTERISTICS AND AC OPERATING CONDITIONS

Parameter	Symbol	-15 (DDR3-1333) [CWL=1.5; 10-10-10]		-12 (DDR3-1600) [CWL=1.25; 11-11-11]		-11 (DDR3-1866) [CWL=1.07; 13-13-13]		Units	Notes
		MIN	MAX	MIN	MAX	MIN	MAX		
<b>ODT Timing</b>									
RTT synchronous TURN-ON delay	ODTL on							CK	38
RTT synchronous TURN-OFF delay	ODTL off							CK	40
RTT TURN-ON from ODTL ON reference	<sup>t</sup> AON	-250	250	-225	225	-195	195	ps	23,38
RTT TURN-OFF from ODTL OFF reference	<sup>t</sup> AOF	0.3	0.7	0.3	0.7	0.3	0.7	CK	39,40
Asynchronous RTT TURN-ON delay (POWER-DOWN with DLL OFF)	<sup>t</sup> AONPD			MIN = 2; MAX = 8.5				ns	38
Asynchronous RTT TURN-OFF delay (POWER-DOWN with DLL OFF)	<sup>t</sup> AOFFPD			MIN = 2; MAX = 8.5				ns	40
ODT HIGH time without WRITE command or with WRITE command and BC8	ODT <sub>H8</sub>			MIN = 6; MAX = n/a				CK	
ODT HIGH time without WRITE command or with WRITE command and BC4	ODT <sub>H4</sub>			MIN = 4; MAX = n/a				CK	
<b>Dynamic ODT Timing</b>									
RTT_NOM-to-RTT_WR change skew	ODTL <sub>CNW</sub>			WL - 2CK				CK	
RTT_WR-to-RTT_NOM change skew - BC4	ODTL <sub>CNW4</sub>			4CK + ODTL OFF				CK	
RTT_WR-to-RTT_NOM change skew - BC8	ODTL <sub>CNW8</sub>			6CK + ODTL OFF				CK	
RTT dynamic change skew	<sup>t</sup> ADC	0.3	0.7	0.3	0.7	0.3	0.7	CK	39
<b>WRITE Leveling Timing</b>									
First DQS, DQS\ RISING edge	<sup>t</sup> WLMRD	40	-	40	-	40	-	CK	
DQS; DQS\ delay	<sup>t</sup> WLDQSEN	25	-	25	-	25	-	CK	
WRITE Leveling SETUP from rising CK, CK\ crossing to rising DQS, DQS\ crossing	<sup>t</sup> WLS	195	-	163	-	140	-	ps	
WRITE Leveling HOLD from rising DQS, DQS\ crossing	<sup>t</sup> WLH	195	-	163	-	140	-	ps	
WRITE Leveling output delay	<sup>t</sup> WLO	0	9	0	7.5	0	7.5	ns	
WRITE Leveling output error	<sup>t</sup> WLOE	0	2	0	2	0	2	ns	

## 16-32 Gb, DDR3, 256-512M x 32 Dual Channel Memory Module

### NOTES

1. Parameters are applicable with  $0^{\circ}\text{C} \leq T_A \leq +95^{\circ}\text{C}$  and  $V_{DD}/V_{DDQ} = +1.35\text{V} \pm 0.0675\text{V}$ .
2. All voltages are referenced to  $V_{SS}$ .
3. Output timings are only valid for RON34 output buffer selection.
4. Unit  $t_{CK}$  (AVG) represents the actual  $t_{CK}$  (AVG) of the input clock under operation. Unit CK represents one clock cycle of the input clock, counting the actual clock edges.
5. AC timing and I<sub>DD</sub> tests may use a  $V_{IL}$ -to- $V_{IH}$  swing of up to 900mV in the test environment, but input timing is still referenced to  $V_{REF}$  (except  $t_{IS}$ ,  $t_{IH}$ ,  $t_{DS}$ , and  $t_{DH}$  use the AC/DC trip points and CK, CK and DQS, DQS\ use their crossing points). The minimum slew rate for the input signals used to test the device is 1V/ns for single-ended inputs and 2V/ns for differential inputs in the range between  $V_{IL}$  (AC) and  $V_{IH}$  (AC).
6. All timings that use time-based values (ns,  $\mu\text{s}$ , ms) should use  $t_{CK}$  (AVG) to determine the correct number of clocks (Table 47 uses CK or CK (AVG) interchangeably). In the ambient of non-interger results, all minimum limits are to be rounded up to the nearest whole integer.
7. The use of STROBE or DQSDIFF refers to the DQS and DQS\ differential crossing point when DQS is the rising edge. The use of CLOCK or CK refers to the CK and CK\ differential crossing point when CK is the rising edge.
8. This output load is used for all AC timing (except ODT reference timing) and slew rates. The actual test load may be different. The output signal voltage reference point is  $V_{DDQ}/2$  for single-ended signals and the crossing point for differential signals.
9. When operating in DLL disable mode, LOGIC Devices, Inc. (LDI) does not warrant compliance with normal mode timings or functionality.
10. The clock's  $t_{CK}$  (AVG) is the average clock over any 200 consecutive clocks and  $t_{CK}$  (AVG) MIN is the smallest clock rate allowed, with the exception of a deviation due to clock jitter. Input clock jitter is allowed provided it does not exceed values specified and must be of a random Gaussian distribution in nature.
11. Spread spectrum is not included in the jitter specification values. However, the input clock can accommodate spread-spectrum at a sweep rate in the range of 20-60kHz with and additional 1% of  $t_{CK}$  (AVG) as a long-term jitter component; however, the spread-spectrum may not use a clock rate below  $t_{CK}$  (AVG) MIN.
12. The clock's  $t_{CH}$  (AVG) and  $t_{CL}$  (AVG) are the average half clock period over any 200 consecutive clocks and is the smallest clock half period allowed, with the exception of values specified and must of a random Gaussian distribution in nature.
13. The period jitter ( $t_{JITPER}$ ) is the maximum deviation in the clock period from the average or nominal clock. It is allowed in either the positive or negative direction.
14.  $t_{CH}$  (ABS) is the absolute instantaneous clock high pulse width as measured from one rising edge to the following falling edge.
15.  $t_{CL}$  (ABS) is the absolute instantaneous clock low pulse width as measured from one falling edge to the following rising edge.
16. The cycle-to-cycle jitter ( $t_{JITCC}$ ) is the amount the clock period can deviate from one cycle to the next. It is important to keep cycle-to-cycle jitter at a minimum during the DLL locking time.
17. The cumulative jitter error ( $t_{ERRnPER}$ ), where n is the number of clocks between 2 and 50, is the amount of clock time allowed to accumulate consecutively away from the average clock over n number of clock cycles.
18.  $t_{DS}$  (base) and  $t_{DH}$  (base) values are for a single-ended 1V/ns DQ slew rate and 2V/ns for differential DQS, DQS\ slew rate.
19. These parameters are measured from a data signal (DM, DQ0, DQ1 ... DQn and so forth) transition edge to its respective data strobe signal (DQS, DQS\ crossing).
20. The setup and hold times are listed converting the base specification values (to which derating tables apply) to  $V_{REF}$  when the slew rate is 1V/ns. These values, with a slew rate of 1V/ns are for reference only.
21. When the device is operated with input clock jitter, this parameter needs to be derated by the actual  $t_{JITPER}$  (larger of  $t_{JITPER}$  (MIN) or  $t_{JITPER}$  (MAX) of the input clock (output deratings are relative to the SDRAM input clock).
22. Single-ended signal parameter.
23. The SDRAM output timing is aligned to the nominal or average clock. Most output parameters must be derated by the actual jitter error when input clock jitter is present, even when within specification. This results in each parameter becoming larger. The following parameters are required to be derated by subtracting  $t_{ERR10PER}$  (MAX);  $t_{DQSCK}$  (MIN),  $t_{LZ}$  (DQS) MAX,  $t_{LZ}$  (DQ) MAX, and  $t_{AON}$  (MAX). The parameter  $t_{RPRE}$  (MIN) is derated by subtracting  $t_{JITPER}$  (MAX), while  $t_{RPRE}$  (MAX) is derated by  $t_{JITPER}$  (MIN).
24. The maximum preamble is bound by  $t_{LZDQS}$  (MAX).
25. These parameters are measured from a data strobe signal (DQS, DQS\ crossing to its respective clock signal (CK, CK\ crossing). The specification values are not affected by the amount of clock jitter applied, as these are relative to the clock signal crossing. These parameters should be met whether clock jitter is present or not.
26. The  $t_{DQSCK}$  DLL\_DIS parameter begins CL + AL - 1 cycles after the READ command.
27. The maximum postamble is bound by  $t_{HZDQS}$  (MAX).
28. Commands requiring a locked DLL are: READ (and RDAP) and synchronous ODT commands. In addition, after any change of latency  $t_{XPDLL}$ , timing must be met.
29.  $t_{IS}$  (base) and  $t_{IH}$  (base) values are for a single-ended 1 V/ns control/ command/ address slew rate and 2 V/ns CK, CK# differential slew rate.
30. These parameters are measured from a command/address signal transition edge to its respective clock (CK, CK\ signal crossing). The specification values are not affected by the amount of clock jitter applied as the setup and hold times are relative to the clock signal crossing that latches the command/address. These parameters should be met whether clock jitter is present or not.
31. For these parameters, the DDR3 SDRAM device supports  $t_{nPARAM}$  ( $nCK$ ) = RU ( $t_{PARAM}$  [ns]/  $t_{CK}$ [AVG][ns]), assuming all input clock jitter specifications are satisfied. For example, the device will support

## 16-32 Gb, DDR3, 256-512M x 32 Dual Channel Memory Module

### NOTES CONTINUED

- $t_{nRP} (nCK) = RU (t_{RP})/t_{CK}[AVG]$  if all input clock jitter specifications are met. This means for DDR2-800; 6-6-6, of which  $t_{RP} = 15ns$ , the device will support  $t_{nRP} = RU (t_{RP}/t_{CK} [AVG]) = 6$  as long as the input clock jitter specifications are met. That is, the PRECHARGE command at T0 and the ACTIVATE command at T0+6 are valid even if six clocks are less than 15ns due to input clock jitter.
32. During READs and WRITEs with AUTO PRECHARGE, the DDR3 SDRAM will hold off the internal PRECHARGE command until  $t_{RAS} (MIN)$  has been satisfied.
  33. When operating in DLL disable mode, the greater of 4CK or 15ns is satisfied for  $t_{WR}$ .
  34. The start of the write recovery time is defined as follows:
    - For BL8 (fixed by MRS and OTF): Rising clock edge four clock cycles after WL.
    - For BC4 (OTF): Rising clock edge four clock cycles after WL.
    - For BC4 (fixed by MRS): Rising clock edge two clock cycles after WL.
  35.  $RESET\$  should be LOW as soon as power starts to ramp to ensure the outputs are in HIGH-Z. Until  $RESET\$  is LOW, the outputs are at risk of driving the bus and could result in excessive current, depending on the bus activity.
  36. The refresh period is 64ms when  $T_A$  is less than or equal to 85°C. This equates to an average refresh rate of 7.8124 $\mu s$ . However, nine REFRESH commands should be asserted at least once every 70.3 $\mu s$ . When  $T_A$  is greater than 85°C, the refresh period is 32ms and when  $T_A$  is greater than 105°C, the refresh period is 24ms.
  37. Although CKE is allowed to be registered LOW after a REFRESH command when  $t_{REFPDEN} (MIN)$  is satisfied, there are cases where additional time such as  $t_{XPDLL} (MIN)$  is required.
  38. ODT turn-on time MIN is when the device leaves HIGH-Z and ODT resistance begins to turn on. ODT turn-on time maximum is when the ODT resistance is fully on. The ODT reference load is shown in Figure 23.
  39. Half-clock output parameters must be derated by the actual  $t_{ERR10PER}$  and  $t_{JITDTY}$  when input clock jitter is present. This results in each parameter becoming larger. The parameters  $t_{ADC} (MIN)$  and  $t_{AOF} (MIN)$  are each required to be derated by subtracting both  $t_{ERR10PER} (MAX)$  and  $t_{JITDTY} (MAX)$ . The parameters  $t_{ADC} (MAX)$  and  $t_{AOF} (MAX)$  are required to be derated by subtracting both  $t_{ERR10PER} (MAX)$  and  $t_{JITDTY} (MAX)$ .
  40. ODT turn-off time minimum is when the device starts to turn off ODT resistance. ODT turn-off time maximum is when the SDRAM buffer is in HIGH-Z. The ODT reference load is shown in Figure 24. This output load is used for ODT timings (see Figure 31).
  41. Pulse width of an input signal is defined as the width between the first crossing of  $V_{REF} (DC)$  and the consecutive crossing of  $V_{REF} (DC)$ .
  42. Should the clock rate be larger than  $t_{RFC} (MIN)$ , an AUTO REFRESH command should have at least one NOP command between it and another AUTO REFRESH command. Additionally, if the clock rate is slower than 40ns (25MHz) all REFRESH commands should be followed by a PRECHARGE ALL command.

## 16-32 Gb, DDR3, 256-512M x 32 Dual Channel Memory Module

### COMMAND AND ADDRESS SETUP, HOLD, AND DERATING

The total  $t_{IS}$  (setup time) and  $t_{IH}$  (hold time) required is calculated by adding the data sheet  $t_{IS}(\text{base})$  and  $t_{IH}(\text{base})$  values (Tables 48) to the  $\Delta t_{IS}$  and  $\Delta t_{IH}$  derating values (Table 49), respectively. Set-up and hold times are based on measurements at the device. Note that address and control pins present the capacitance of multiple die to the system. This capacitance is less than the equivalent number of discrete devices due to the higher level of die integration; however, it must be accounted for when driving these pins. Slew rates on these pins will be slower than pins with only one die load unless measures are made to increase the strength of the signal driver and lower the trace impedance proportionally on signals connecting to multiple internal die.

Although the total setup time for slow slew rates might be negative, a valid input signal is still required to complete the transition and to reach  $V_{IH(AC)}/V_{IL(AC)}$  (see Figure 14 for input signal requirements). For slew rates which fall between the values listed in Table 49 and Table 50, the derating values may be obtained by linear interpolation.

Setup ( $t_{IS}$ ) nominal slew rate for a rising signal is defined as the slew rate between the last crossing of  $V_{REF(DC)}$  and the first crossing of  $V_{IH(AC)} \text{ MIN}$ . Setup ( $t_{IS}$ ) nominal slew rate for a falling signal is defined as the slew rate between the last crossing of  $V_{REF(DC)}$  and the first crossing of  $V_{IL(AC)} \text{ MAX}$ . If the actual signal is always earlier than the nominal slew rate line between the shaded "VREF(DC)-to-AC region", use the nominal slew rate for derating value (see Figure 25). If the actual signal is later than the nominal slew rate line anywhere between the shaded "VREF(DC)-to-AC region", the slew rate of a tangent line to the actual signal from the AC level to the DC level is used for the derating value (see Figure 27).

Hold ( $t_{IH}$ ) nominal slew rate for a rising signal is defined as the slew rate between the last crossing of  $V_{IL(DC)} \text{ MAX}$  and the first crossing of  $V_{REF(DC)}$ . Hold ( $t_{IH}$ ) nominal slew rate for a falling signal is defined as the slew rate between the last crossing of  $V_{IH(DC)} \text{ MIN}$  and the first crossing of  $V_{REF(DC)}$ . If the actual signal is always later than the nominal slew rate line between the shaded "DC-to-VREF(DC) region", use the nominal slew rate for derating value (see Figure 26). If the actual signal is earlier than the nominal slew rate line anywhere between the shaded "DC-to-VREF(DC) region", the slew rate of a tangent line to the actual signal from the DC level to the  $V_{REF(DC)}$  level is used for the derating value (see Figure 28).

TABLE 48: COMMAND AND ADDRESS SETUP AND HOLD VALUES REFERENCED AT 1V/NS – AC/DC BASED					
Symbol	DDR3-1333	DDR3-1600	DDR3-1866	UNITS	REFERENCE
$t_{IS}(\text{base})_{AC}$	600	600	-	ps	$V_{IH(AC)}/V_{IL(AC)}$
$t_{IS}(\text{base})_{AC}$	600	600	-	ps	$V_{IH(AC)}/V_{IL(AC)}$
$t_{IH}(\text{base})_{DC100}$	600	600	600	ps	$V_{IH(AC)}/V_{IL(AC)}$

TABLE 49: DERATING VALUES FOR $t_{IS}/t_{IH}$ – AC175/DC100-BASED																
Shaded cells indicate slew-rate combinations not supported																
$\Delta t_{IS}, \Delta t_{IH}$ Derating (ps) - AC/DC-Based, AC175 Threshold; $V_{IH(AC)} = V_{REF(DC)} + 175\text{mV}$ , $V_{IL(AC)} = V_{REF(DC)} - 175\text{mV}$																
CMD/ADDR Slew Rate V/ns	CK, CKI Differential Slew Rate															
	4.0V/ns		3.0V/ns		2.0V/ns		1.8V/ns		1.6V/ns		1.4V/ns		1.2V/ns		1.0V/ns	
	$\Delta t_{IS}$	$\Delta t_{IH}$	$\Delta t_{IS}$	$\Delta t_{IH}$	$\Delta t_{IS}$	$\Delta t_{IH}$	$\Delta t_{IS}$	$\Delta t_{IH}$	$\Delta t_{IS}$	$\Delta t_{IH}$	$\Delta t_{IS}$	$\Delta t_{IH}$	$\Delta t_{IS}$	$\Delta t_{IH}$	$\Delta t_{IS}$	$\Delta t_{IH}$
2.0	88	50	88	50	88	50	96	58	96	66	112	74	120	84	128	100
1.5	59	34	50	34	59	34	67	42	67	50	83	58	91	68	99	84
1.0	0	0	0	0	0	0	8	8	8	16	24	24	32	34	40	50
0.9	-2	-4	-2	-4	-2	-4	6	4	6	12	22	20	30	30	38	46
0.8	-6	-10	-6	-10	-6	-10	2	-2	2	6	18	14	26	24	34	40
0.7	-11	-16	-11	-16	-11	-16	-3	-8	-3	0	13	8	21	18	29	34
0.6	-17	-26	-17	-26	-17	-26	-9	-18	-9	-10	7	-2	15	8	23	24
0.5	-35	-40	-35	-40	-35	-40	-27	-32	-27	-24	-11	-16	-2	-6	5	10
0.4	-62	-60	-62	-60	-62	-60	-54	-52	-54	-44	-38	-36	-30	-26	-22	-10

16-32 Gb, DDR3, 256-512M x 32 Dual Channel Memory Module

**TABLE 50: DERATING VALUES FOR  $t_{IS}/t_{IH}$  – AC150/DC100-BASED**

*Shaded cells indicate slew-rate combinations not supported*

$\Delta t_{IS}$ ,  $\Delta t_{IH}$  Derating (ps) - AC/DC-Based, AC150 Threshold;  $V_{IH}(AC) = V_{REF}(DC) + 150mV$ ,  $V_{IL}(AC) = V_{REF}(DC) - 150mV$

CMD/ADDR Slew Rate V/ns	CK, CK\ Differential Slew Rate															
	4.0V/ns		3.0V/ns		2.0V/ns		1.8V/ns		1.6V/ns		1.4V/ns		1.2V/ns		1.0V/ns	
	$\Delta t_{IS}$	$\Delta t_{IH}$	$\Delta t_{IS}$	$\Delta t_{IH}$	$\Delta t_{IS}$	$\Delta t_{IH}$	$\Delta t_{IS}$	$\Delta t_{IH}$	$\Delta t_{IS}$	$\Delta t_{IH}$	$\Delta t_{IS}$	$\Delta t_{IH}$	$\Delta t_{IS}$	$\Delta t_{IH}$	$\Delta t_{IS}$	$\Delta t_{IH}$
2.0	75	50	75	50	75	50	83	58	91	66	99	74	107	84	115	100
1.5	50	34	50	34	50	34	58	42	66	50	74	58	82	68	90	84
1.0	0	0	0	0	0	0	8	8	16	16	24	24	32	34	40	50
0.9	0	-4	0	-4	0	-4	8	4	16	12	24	20	32	30	40	46
0.8	0	-10	0	-10	0	-10	8	-2	16	6	24	14	32	24	40	40
0.7	0	-16	0	-16	0	-16	8	-8	16	0	24	8	32	18	40	34
0.6	-1	-26	-1	-26	-1	-26	7	-18	15	-10	23	-2	31	8	39	24
0.5	-10	-40	-10	-40	-10	-40	-2	-32	6	-24	14	-16	22	-6	30	10
0.4	-25	-60	-25	-60	-25	-60	-17	-52	-9	-44	-1	-36	7	-26	15	-10

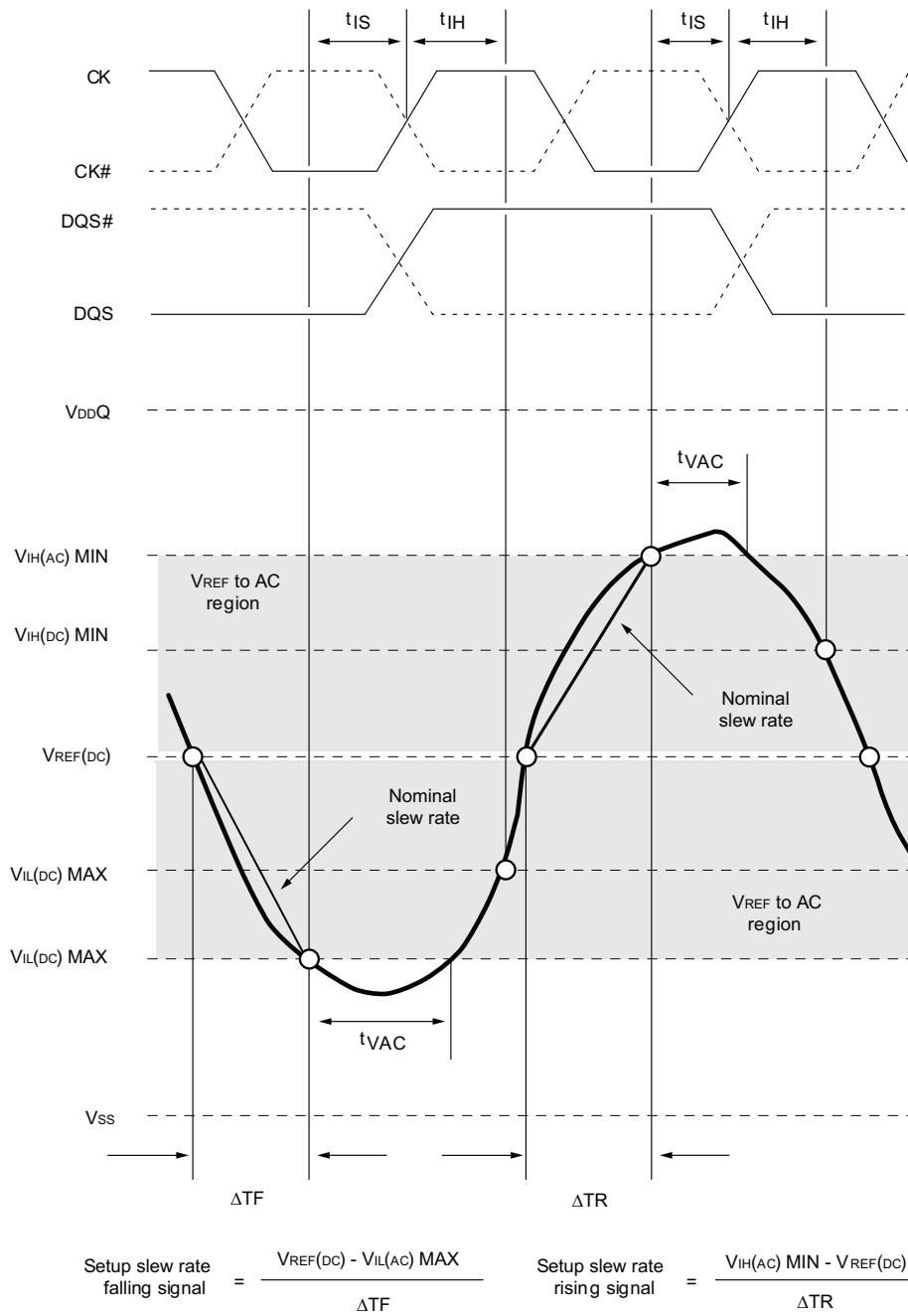
**TABLE 51: MINIMUM REQUIRED TIME  $t_{VAC}$  ABOVE  $V_{IH}(AC)$  FOR A VALID TRANSITION**

*Below  $V_{IL}(AC)$*

Slew Rate (V/ns)	$t_{VAC}$ at 175mV(ps)	$t_{VAC}$ at 150mV(ps)	$t_{VAC}$ at 135mV(ps)	$t_{VAC}$ at 125mV(ps)
>2.0	75	175	175	200
2.0	57	170	160	190
1.5	50	167	150	180
1.0	38	163	140	170
0.9	34	162	130	160
0.8	29	161	120	150
0.7	22	159	110	n/a
0.6	13	155	105	n/a
0.5	0	150	n/a	n/a
<0.5	0	150	n/a	n/a

**16-32 Gb, DDR3, 256-512M x 32 Dual Channel Memory Module**

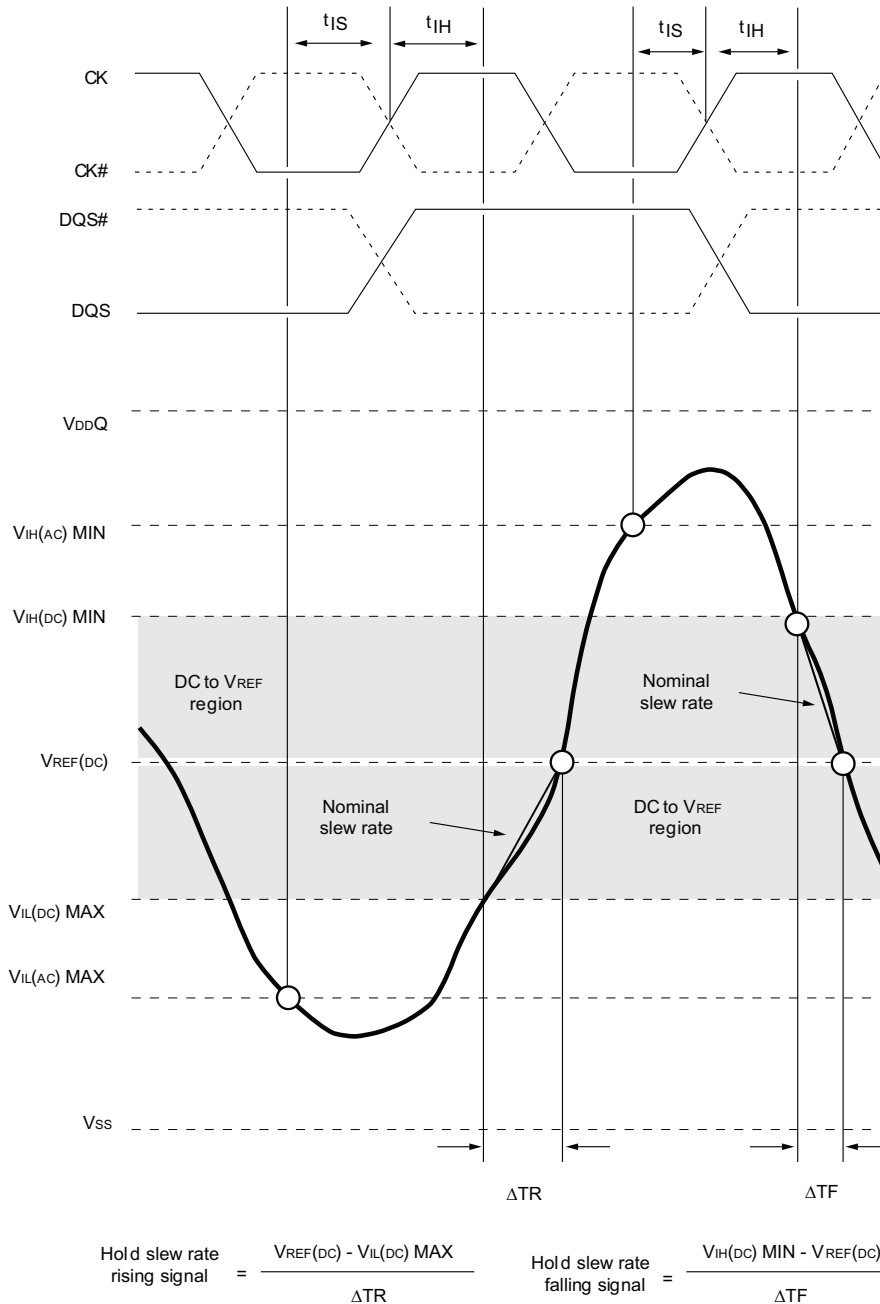
**FIGURE 25 - NOMINAL SLEW RATE AND tVAC FOR tIS (COMMAND AND ADDRESS – CLOCK)**



Notes: 1. Both the clock and the strobe are drawn on different time scales.

**16-32 Gb, DDR3, 256-512M x 32 Dual Channel Memory Module**

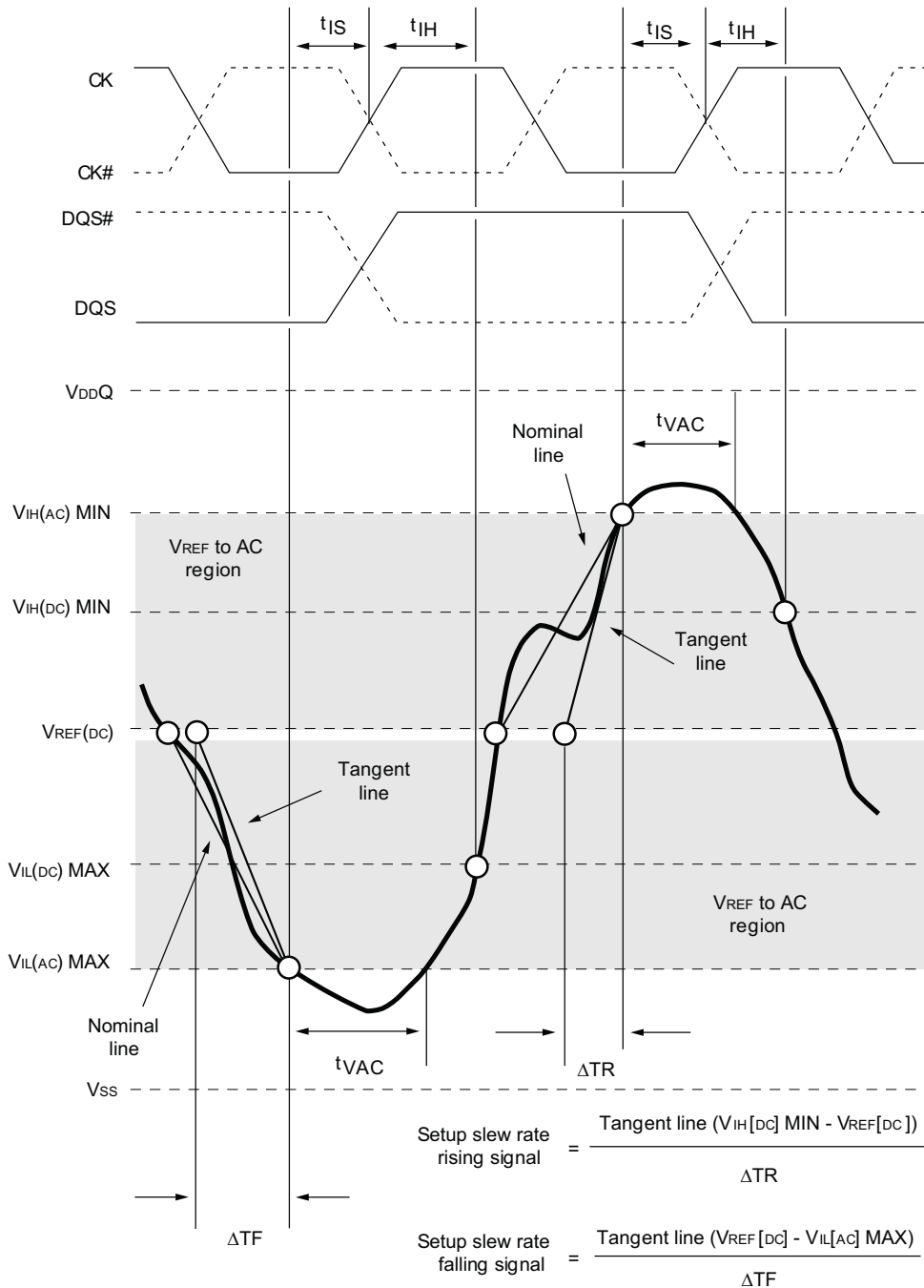
**FIGURE 26 - NOMINAL SLEW RATE FOR  $t_{IH}$  (COMMAND AND ADDRESS – CLOCK)**



Notes: 1. Both the clock and the strobe are drawn on different time scales.

16-32 Gb, DDR3, 256-512M x 32 Dual Channel Memory Module

**FIGURE 27 - TANGENT LINE FOR  $t_{IS}$  (COMMAND AND ADDRESS – CLOCK)**

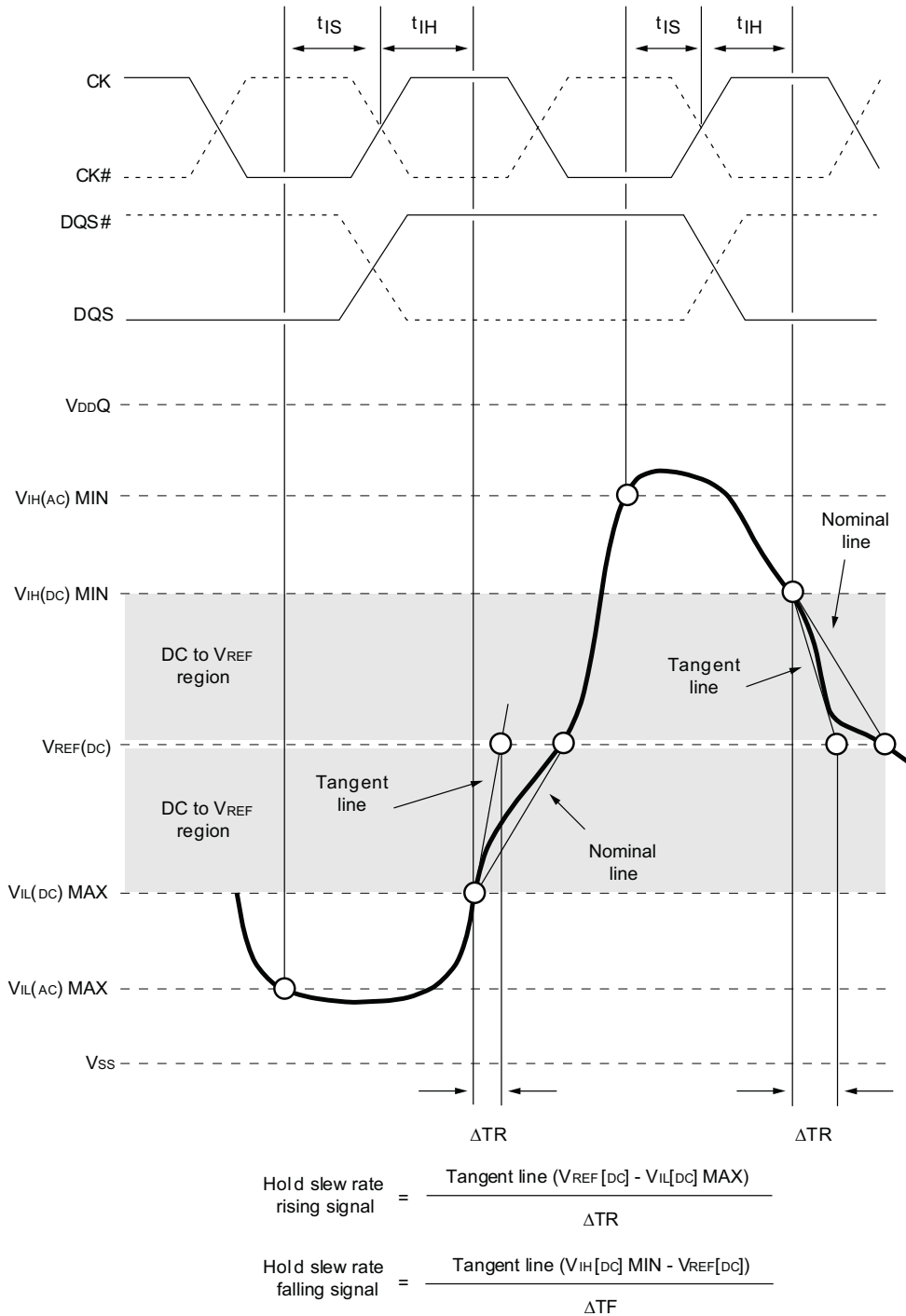


Notes: 1. Both the clock and the strobe are drawn on different time scales.



16-32 Gb, DDR3, 256-512M x 32 Dual Channel Memory Module

**FIGURE 28 - TANGENT LINE FOR  $t_{IH}$  (COMMAND AND ADDRESS – CLOCK)**



Notes: 1. Both the clock and the strobe are drawn on different time scales.

## 16-32 Gb, DDR3, 256-512M x 32 Dual Channel Memory Module

### DATA SETUP, HOLD AND DERATING

The total  $t_{DS}$  (setup time) and  $t_{DH}$  (hold time) required is calculated by adding the data sheet  $t_{DS}$  (base) and  $t_{DH}$  (base) values (see Table 52) to the  $\Delta t_{DS}$  and  $\Delta t_{DH}$  derating values (see Table 53), respectively.

Although the total setup time for slow slew rates might be negative, a valid input signal is still required to complete the transition and to reach  $V_{IH}/V_{IL}(AC)$ . For slew rates which fall between the values listed in Table 54, the derating values may be obtained by linear interpolation.

Setup ( $t_{DS}$ ) nominal slew rate for a rising signal is defined as the slew rate between the last crossing of  $V_{REF}(DC)$  and the first crossing of  $V_{IH}(AC)$  MIN. Setup ( $t_{DS}$ ) nominal slew rate for a falling signal is defined as the slew rate between the last crossing of  $V_{REF}(DC)$  and the first crossing of  $V_{IL}(AC)$  MAX. If the actual signal is always earlier than the nominal slew rate line between the shaded "VREF(DC)-to-AC region", use the nominal slew rate derating value (see Figure 29). If the actual signal is later than the nominal slew rate line anywhere between the shaded "VREF(DC)-to-AC region", the slew rate of a tangent line to the actual signal from the AC level to the DC level is used for the derating value (see Figure 31).

Hold ( $t_{DH}$ ) nominal slew rate for a rising signal is defined as the slew rate between the last crossing of  $V_{IL}(DC)$  MAX and the first crossing of  $V_{REF}(DC)$ . Hold ( $t_{DH}$ ) nominal slew rate for a falling signal is defined as the slew rate between the last crossing of  $V_{IH}(DC)$  MIN and the first crossing of  $V_{REF}(DC)$ . If the actual signal is always later than the nominal slew rate line between the shaded "DC-to-VREF(DC) region", use the nominal slew rate for derating value (see Figure 30). If the actual signal is earlier than the nominal slew rate line anywhere between the shaded "DC-to-VREF(DC) region", the slew rate of a tangent line to the actual signal from the "DC-to-VREF(DC) region", is used for the derating value (see Figure 32).

TABLE 52: DATA SETUP AND HOLD VALUES AT 1V/NS (DQSx, DQSx\ AT 2V/NS) - AC/DC BASED					
Symbol	DDR3-1333	DDR3-1600	DDR3-1866	UNITS	REFERENCE
$t_{DS}(base)AC175$	-	-	-	ps	$V_{IH}(AC)/V_{IL}(AC)$
$t_{DS}(base)AC175$	-	-	-	ps	$V_{IH}(AC)/V_{IL}(AC)$
$t_{DS}(base)DC150$	30	10	10	ps	$V_{IH}(AC)/V_{IL}(AC)$
$t_{DS}(base)DC150$	65	45	45	ps	$V_{IH}(AC)/V_{IL}(AC)$

TABLE 53: DERATING VALUE FOR $t_{DS}/t_{DH}$ – AC175/DC100 - BASED																
Shaded cells indicate slew-rate combinations not supported																
$\Delta t_{DS}, \Delta t_{DH}$ Derating (ps) – AC175/D100-Based																
DQ Slew Rate V/ns	DQS, DQS# Differential Slew Rate															
	4.0V/ns		3.0V/ns		2.0V/ns		1.8V/ns		1.6V/ns		1.4V/ns		1.2V/ns		1.0V/ns	
	$\Delta t_{DS}$	$\Delta t_{DH}$	$\Delta t_{DS}$	$\Delta t_{DH}$	$\Delta t_{DS}$	$\Delta t_{DH}$	$\Delta t_{DS}$	$\Delta t_{DH}$	$\Delta t_{DS}$	$\Delta t_{DH}$	$\Delta t_{DS}$	$\Delta t_{DH}$	$\Delta t_{DS}$	$\Delta t_{DH}$	$\Delta t_{DS}$	$\Delta t_{DH}$
2.0	88	50	88	50	88	50										
1.5	59	34	59	34	59	34	67	42								
1.0	0	0	0	0	0	0	8	8	16	16						
0.9			-2	-4	-2	-4	6	4	14	12	22	20				
0.8					-6	-10	2	-2	10	6	18	14	26	24		
0.7							-3	-8	5	0	13	8	21	18	29	34
0.6									-1	-10	7	-2	15	8	23	24
0.5											-11	-16	-2	-6	5	10
0.4													-30	-26	-22	-10

16-32 Gb, DDR3, 256-512M x 32 Dual Channel Memory Module

**TABLE 54: DERATING VALUE FOR  $t_{DS}/t_{DH}$  – AC150/DC100 - BASED**

*Shaded cells indicate slew-rate combinations not supported*

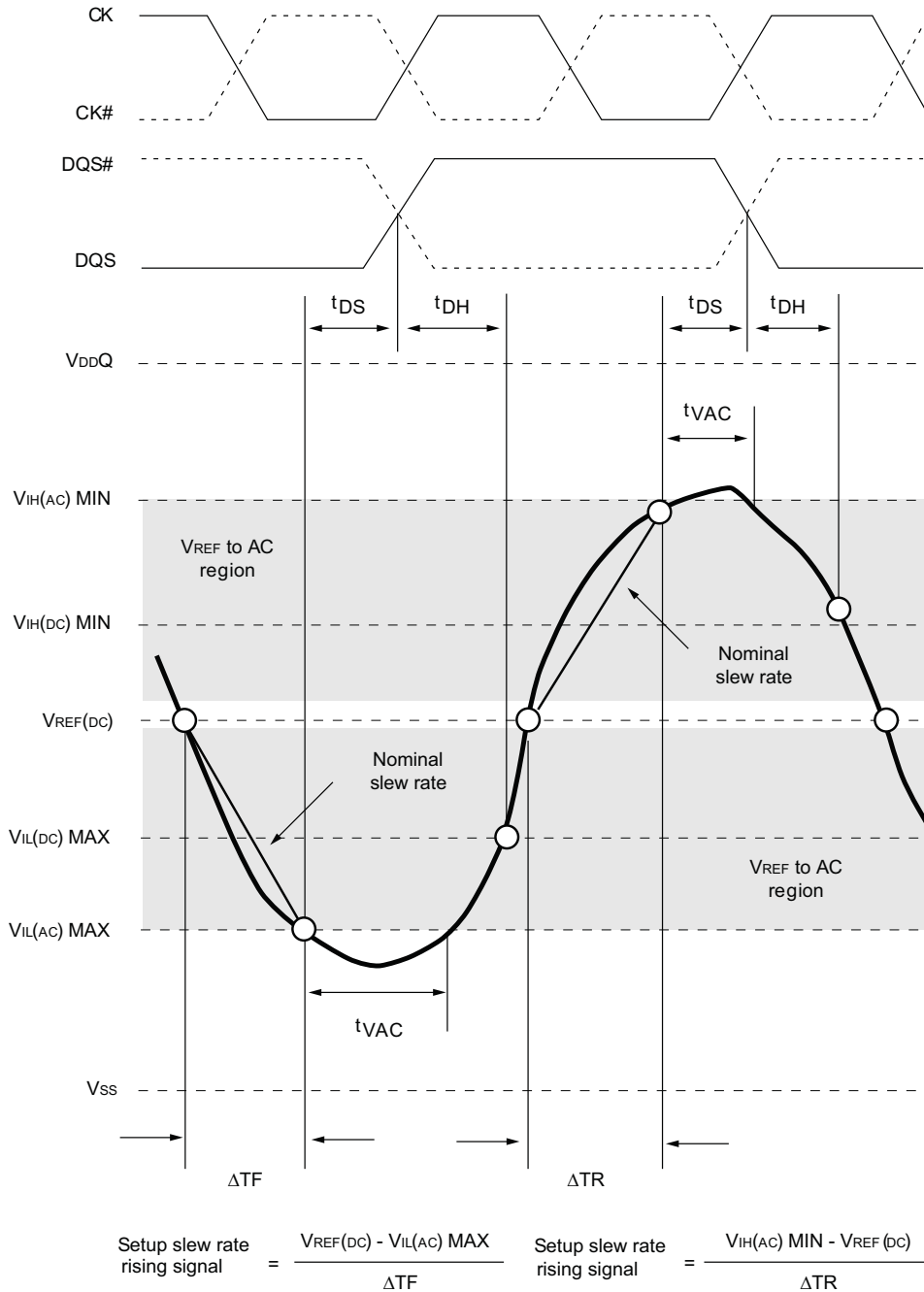
**$\Delta t_{DS}$ ,  $\Delta t_{DH}$  Derating (ps) – AC150/DC100-Based**

DQ Slew Rate V/ns	DQS, DQS# Differential Slew Rate															
	4.0V/ns		3.0V/ns		2.0V/ns		1.8V/ns		1.6V/ns		1.4V/ns		1.2V/ns		1.0V/ns	
	$\Delta t_{DS}$	$\Delta t_{DH}$	$\Delta t_{DS}$	$\Delta t_{DH}$	$\Delta t_{DS}$	$\Delta t_{DH}$	$\Delta t_{DS}$	$\Delta t_{DH}$	$\Delta t_{DS}$	$\Delta t_{DH}$	$\Delta t_{DS}$	$\Delta t_{DH}$	$\Delta t_{DS}$	$\Delta t_{DH}$	$\Delta t_{DS}$	$\Delta t_{DH}$
2.0	75	50	75	50	75	50										
1.5	50	34	50	34	50	34	58	42								
1.0	0	0	0	0	0	0	8	8	16	16						
0.9			0	-4	0	-4	8	4	16	12	24	20				
0.8					0	-10	8	-2	16	6	24	14	32	24		
0.7							8	-8	16	0	24	8	32	18	40	34
0.6									15	-10	23	-2	31	8	39	24
0.5											14	-16	22	-6	30	10
0.4													7	-26	15	-10

**TABLE 55: REQUIRED TIME  $t_{VAC}$  ABOVE  $V_{IH}(AC)$  (BELOW  $V_{IL}(AC)$ ) FOR A VALID TRANSITION**

Slew Rate (V/ns)	$t_{VAC}$ at 175mV(ps) [MIN]	$t_{VAC}$ at 150mV(ps) [MIN]
>2.0	75	175
2.0	57	170
1.5	50	167
1.0	38	163
0.9	34	162
0.8	29	161
0.7	22	159
0.6	13	155
0.5	0	150
<0.5	0	150

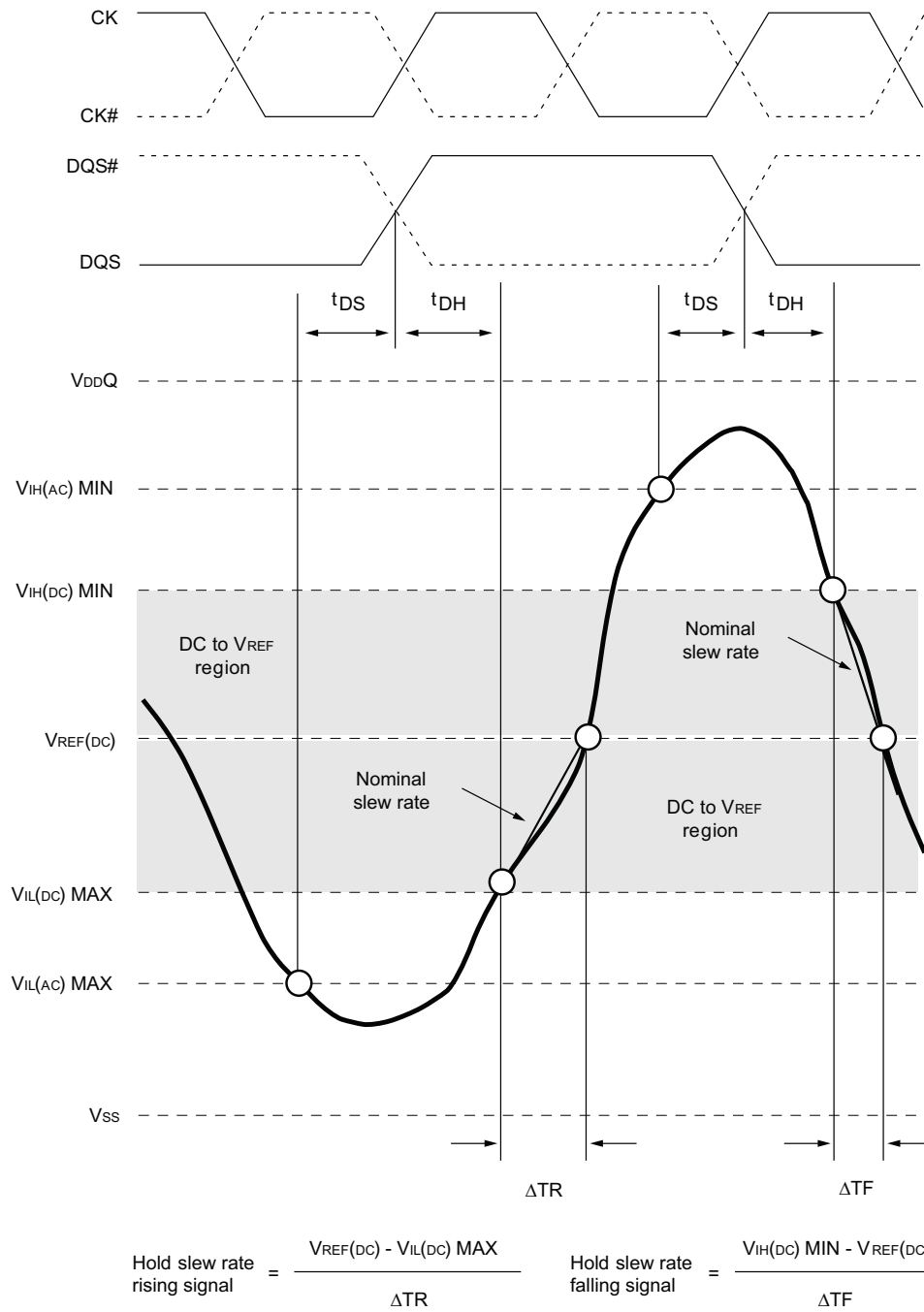
**FIGURE 29 - NOMINAL SLEW RATE AND tVAC FOR tDS (DQ – STROBE)**



Notes: 1. Both the clock and the strobe are drawn on different time scales.

16-32 Gb, DDR3, 256-512M x 32 Dual Channel Memory Module

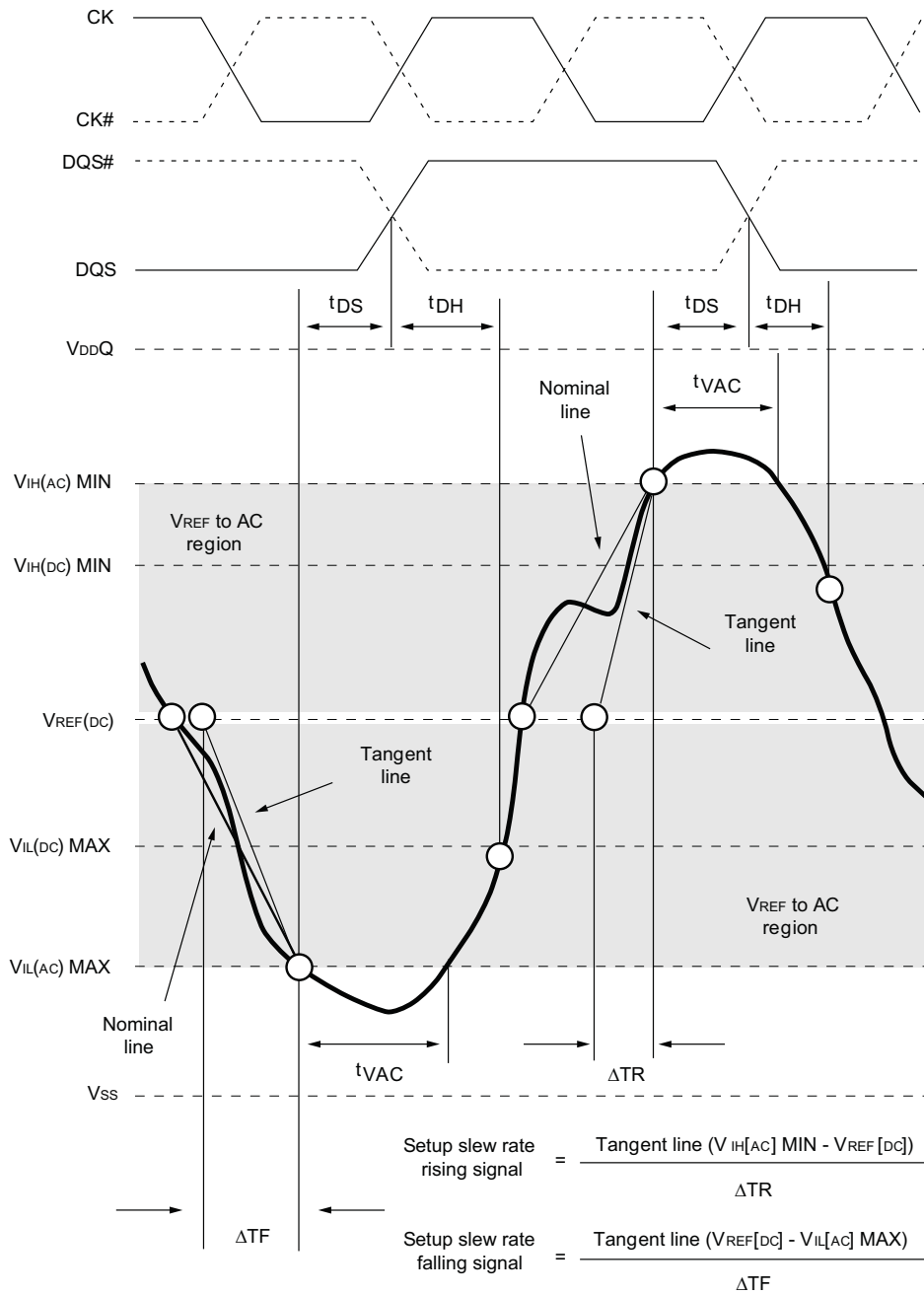
**FIGURE 30 - NOMINAL SLEW RATE FOR  $t_{DH}$  (DQ – STROBE)**



Notes: 1. Both the clock and the strobe are drawn on different time scales.

**16-32 Gb, DDR3, 256-512M x 32 Dual Channel Memory Module**

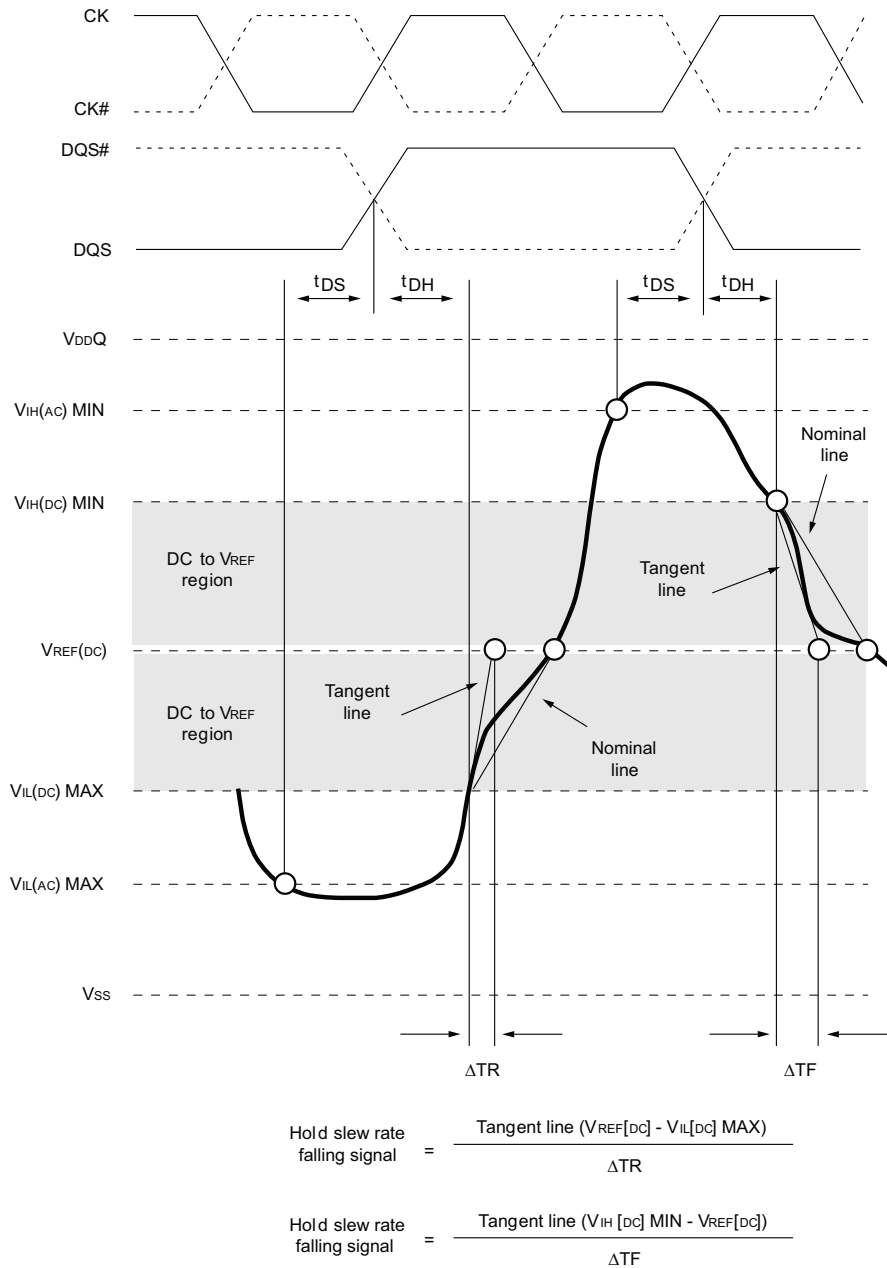
**FIGURE 31 - NOMINAL SLEW RATE AND tVAC FOR tDS (DQ – STROBE)**



Notes: 1. Both the clock and the strobe are drawn on different time scales.

**16-32 Gb, DDR3, 256-512M x 32 Dual Channel Memory Module**

**FIGURE 32 - NOMINAL SLEW RATE FOR  $t_{DH}$  (DQ – STROBE)**



Notes: 1. Both the clock and the strobe are drawn on different time scales.

## 16-32 Gb, DDR3, 256-512M x 32 Dual Channel Memory Module

### COMMANDS TRUTH TABLE

**TABLE 56: TRUTH TABLE - COMMAND**

Function		CKE		CS\	RAS\	CAS\	WE\	BA <sub>[2:0]</sub>	A <sub>n</sub>	A <sub>12</sub>	A <sub>10</sub>	A <sub>[11,0:0]</sub>	Notes	
		Prev Cycle	Next Cycle											
Mode Register Set		MRS	H	H	L	L	L	L	BA					
REFRESH		REF	H	H	L	L	L	H	V	V	V	V	V	
SELF REFRESH entry		SRE	H	L	L	L	H	V	V	V	V	V	V	6
SELF REFRESH exit		SRX	L	H	H	V	V	V	V	V	V	V	V	6,7
Single-Bank PRECHARGE		PRE	H	H	L	L	L	L	VBA	V	V	L	V	
PRECHARGE all banks		PREA	H	H	L	L	L	L	V	V	V	H	V	
Bank ACTIVATE		ACT	H	H	L	L	L	H	BA				RA	
WRITE	BL8MRS BC4MRS	WR	H	H	L	H	H	L	BA	RFU	V	L	CA	8
	BC4OTF	WRS4	H	H	L	H	H	L	BA	RFU	L	L	CA	8
	BL8OTF	WRS8	H	H	L	H	H	L	BA	RFU	H	L	CA	8
WRITE with AUTO PRECHARGE	BL8MRS BC4MRS	WRAP	H	H	L	H	H	L	BA	RFU	V	H	CA	8
	BC4OTF	WRAPS4	H	H	L	H	H	L	BA	RFU	L	H	CA	8
	BL8OTF	WRAPS8	H	H	L	H	H	L	BA	RFU	H	H	CA	8
READ	BL8MRS BC4MRS	RD	H	H	L	H	H	H	BA	RFU	V	L	CA	8
	BC4OTF	RDS4	H	H	L	H	H	H	BA	RFU	L	L	CA	8
	BL8OTF	RDS8	H	H	L	H	H	H	BA	RFU	H	L	CA	8
READ with AUTO PRECHARGE	BL8MRS BC4MRS	RDAP	H	H	L	H	H	H	BA	RFU	V	H	CA	8
	BC4OTF	RDAPS4	H	H	L	H	H	H	BA	RFU	L	H	CA	8
	BL8OTF	RDAPS8	H	H	L	H	H	H	BA	RFU	H	H	CA	8
NO OPERATION		NOP	H	H	L	H	H	H	V	V	V	V	V	9
Device DESELECTED		DES	H	H	H	X	X	X	X	X	X	X	X	10
POWER-DOWN entry		PDE	H	L	L	H	V	V	V	V	V	V	V	6
POWER-DOWN exit		PDX	L	H	L	H	V	V	V	V	V	V	V	6,11
ZQ CALIBRATION LONG		ZQCL	H	H	L	H	H	L	X	X	X	H	X	12
ZQ CALIBRATION SHORT		ZQCS	H	H	L	H	H	L	X	X	X	L	X	

**NOTES:**

- Commands are defined by states of CS\, RAS\, CAS\, WE\, and CKE at the rising edge of the clock. The MSB of BA, RA, and CA are device-density and configuration-dependent.
- RESET\ is LOW enabled and used only for asynchronous RESET. Thus, RESET\ must be held HIGH during any normal operation.
- The state of ODT does not affect the states described in this table.
- Operations apply to the bank defined by the bank address. For MRS, BA selects one of four mode registers.
- "V" means "H" or "L" (a defined logic level), and "X" means "Don't Care".
- See Table 57 for additional information on CKE transition.
- SELF REFRESH exit is asynchronous.
- Burst READs or WRITEs cannot be terminated or interrupted, MRS (fixed) and OTF BL/BC are defined in MR0.
- The purpose of the NOP command is to prevent the SDRAM from registering any unwanted commands. A NOP will not terminate an operation that is in execution.
- The DES and NOP commands perform similarly.
- The POWER-DOWN mode does not perform any REFRESH operations.
- ZQ CALIBRATION LONG is used for either ZQINT (first ZQCL command during initialization) or ZQOPER (ZQCL command after initialization).



## 16-32 Gb, DDR3, 256-512M x 32 Dual Channel Memory Module

**TABLE 57: TRUTH TABLE - CKE**

Current State <sup>3</sup>	CKE		(RAS, CAS, WE, CS) Command <sup>5</sup>	Action <sup>5</sup>	Notes
	(n-1) Previous Cycle <sup>4</sup>	(n) Present Cycle <sup>4</sup>			
POWER-DOWN	L	L	"Don't Care"	Maintain POWER-DOWN	1,2
	L	H	DES or NOP	POWER-DOWN exit	1,2
SELF REFRESH	L	L	"Don't Care"	Maintain SELF REFRESH	1,2
Bank(s) ACTIVE	H	H	DES or NOP	SELF REFRESH exit	1,2
READING	H	L	DES or NOP	Active POWER-DOWN entry	1,2
WRITING	H	L	DES or NOP	POWER-DOWN entry	1,2
PRECHARGING	H	L	DES or NOP	POWER-DOWN entry	1,2
REFRESHING	H	L	DES or NOP	PRECHARGE POWER-DOWN entry	1,2
All Banks IDLE	H	L	DES or NOP	PRECHARGE POWER-DOWN entry	1,2,6
	H	L	REFRESH	SELF REFRESH	

**NOTES:**

- All states and sequences not shown are illegal or reserved unless explicitly described elsewhere in this document.
- <sup>1</sup>tCKE(MIN) means CKE must be registered at multiple consecutive positive clock edges. CKE must remain at the valid input level the entire time it takes to achieve the required number of registration clocks. Thus, after any CKE transition, CKE may not transition from its valid level during the time period of <sup>1</sup>tS + <sup>1</sup>tCKE(MIN) + <sup>1</sup>tIH.
- Current state = The state of the SDRAM immediately prior to clock edge n.
- CKE (n) is the logic state of CKE at clock edge n, CKE (n-1) was the state of CKE at the previous clock edge.
- COMMAND is the command registered at the clock edge (must be a legal command as defined in Table 56). Action is a result of COMMAND. ODT does not affect the states described in this table and is not listed.
- Idle state = all banks are closed, no data bursts are in progress, CKE is HIGH and all timings from previous operations are satisfied. All SELF REFRESH exit and POWER-DOWN exit parameters are also satisfied.

### DESELECT (DES)

The DES command (CS\ HIGH) prevents new commands from being executed by the SDRAM. Operations already in progress are not affected.

### NO OPERATION (NOP)

The NOP command (CS\ LOW) prevents unwanted commands from being registered during idle or wait states. Operations already in progress are not affected.

## ZQ CALIBRATION

### ZQ Calibration LONG (ZQCL)

The ZQCL command is used to perform the initial calibration during a power-up initialization and reset sequence. This command may be issued at any time by the controller depending on the system environment. The ZQCL command triggers the calibration engine inside the SDRAM. After calibration is achieved, the calibrated values are transferred from the calibration engine to the SDRAM I/O, which are reflected as updated RON and ODT values.

The SDRAM is allowed a timing window defined by either <sup>1</sup>tZQINIT or <sup>1</sup>tZQOPER to perform the full calibration and transfer of values. When ZQCL is issued during the initialization sequence, the timing parameter <sup>1</sup>tZQINIT must be satisfied. When initialization is complete, subsequent ZQCL commands require the timing parameter <sup>1</sup>tZQOPER to be satisfied.

### ZQ Calibration SHORT (ZQCS)

The ZQCS command is used to perform periodic calibrations to account for small voltage and temperature variations. The shorter timing window is provided to perform the reduced calibration and transfer of values as defined by timing parameter <sup>1</sup>tZQCS. A ZQCS command can effectively correct a minimum of 0.5% RON and RTT impedance errors within 64 clock cycles, assuming the maximum sensitivities specified in Table 37 and Table 38.

## 16-32 Gb, DDR3, 256-512M x 32 Dual Channel Memory Module

### ACTIVATE

The ACTIVATE command is used to open (or ACTIVATE) a row in a particular bank for a subsequent access. The value on the BA [2:0] inputs selects the bank, and the address provided on inputs A[n:0] selects the row. This row remains open (or ACTIVE) for accesses until a PRECHARGE command is issued to that bank.

A PRECHARGE command must be issued before opening a different row in the same bank.

### READ

The READ command is used to initiate a burst READ access to an ACTIVE row. The address provided on inputs A[2:0] selects the starting column address depending on the burst length and burst type selected (see table 60). The value on input A10 determines whether or not auto precharge is used. If auto precharge is selected, the row being accessed will be PRECHARGED at the end of the READ burst. If AUTO PRECHARGE is not selected, the row will remain open for subsequent accesses. The value on input A12 (if enabled in the MODE REGISTER) when the READ command is issued, determines whether BC4 (chop) or BL8 is used. After a READ command is issued, the READ burst may not be interrupted. A summary of READ commands is shown in Table 58.

**TABLE 58: READ COMMAND SUMMARY**

Function		Symbol	CKE		CS\	RAS\	CAS\	WE\	BA[2:0]	A <sub>n</sub>	A <sub>12</sub>	A <sub>10</sub>	A <sub>[11,0:0]</sub>	Notes
			Prev Cycle	Next Cycle										
READ	BL8MRS BC4MRS	RD	H		L	H	L	H	BA	RFU	V	L	CA	
	BC4OTF	RDS4	H		L	H	L	H	BA	RFU	L	L	CA	
	BL8OTF	RDS8	H		L	H	L	H	BA	RFU	H	L	CA	
READ with AUTO PRECHARGE	BL8MRS BC4MRS	RDAP	H		L	H	L	H	BA	RFU	V	H	CA	
	BC4OTF	RDAPS4	H		L	H	L	H	BA	RFU	L	H	CA	
	BL8OTF	RDAPS8	H		L	H	L	H	BA	RFU	H	H	CA	

### WRITE

The WRITE command is used to initiate a burst WRITE access to an ACTIVE row. The value on the BA[2:0] inputs selects the bank. The value on input A10 determines whether or not AUTO PRECHARGE is used. The value on input A12 (if enabled in the MODE REGISTER [MR]) when the WRITE command is issued, determines whether BC4 (chop) or BL8 is used. The WRITE command summary is shown in Table 62.

**TABLE 59: WRITE COMMAND SUMMARY**

Function		Symbol	CKE		CS\	RAS\	CAS\	WE\	BA[2:0]	A <sub>n</sub>	A <sub>12</sub>	A <sub>10</sub>	A <sub>[11,0:0]</sub>	Notes
			Prev Cycle	Next Cycle										
WRITE	BL8MRS BC4MRS	WR	H		L	H	L	L	BA	RFU	V	L	CA	
	BC4OTF	WRS4	H		L	H	L	L	BA	RFU	L	L	CA	
	BL8OTF	WRS8	H		L	H	L	L	BA	RFU	H	L	CA	
WRITE with AUTO PRECHARGE	BL8MRS BC4MRS	WRAP	H		L	H	L	L	BA	RFU	V	H	CA	
	BC4OTF	WRAPS4	H		L	H	L	L	BA	RFU	L	H	CA	
	BL8OTF	WRAPS8	H		L	H	L	L	BA	RFU	H	H	CA	

**16-32 Gb, DDR3, 256-512M x 32 Dual Channel Memory Module**

**PRECHARGE**

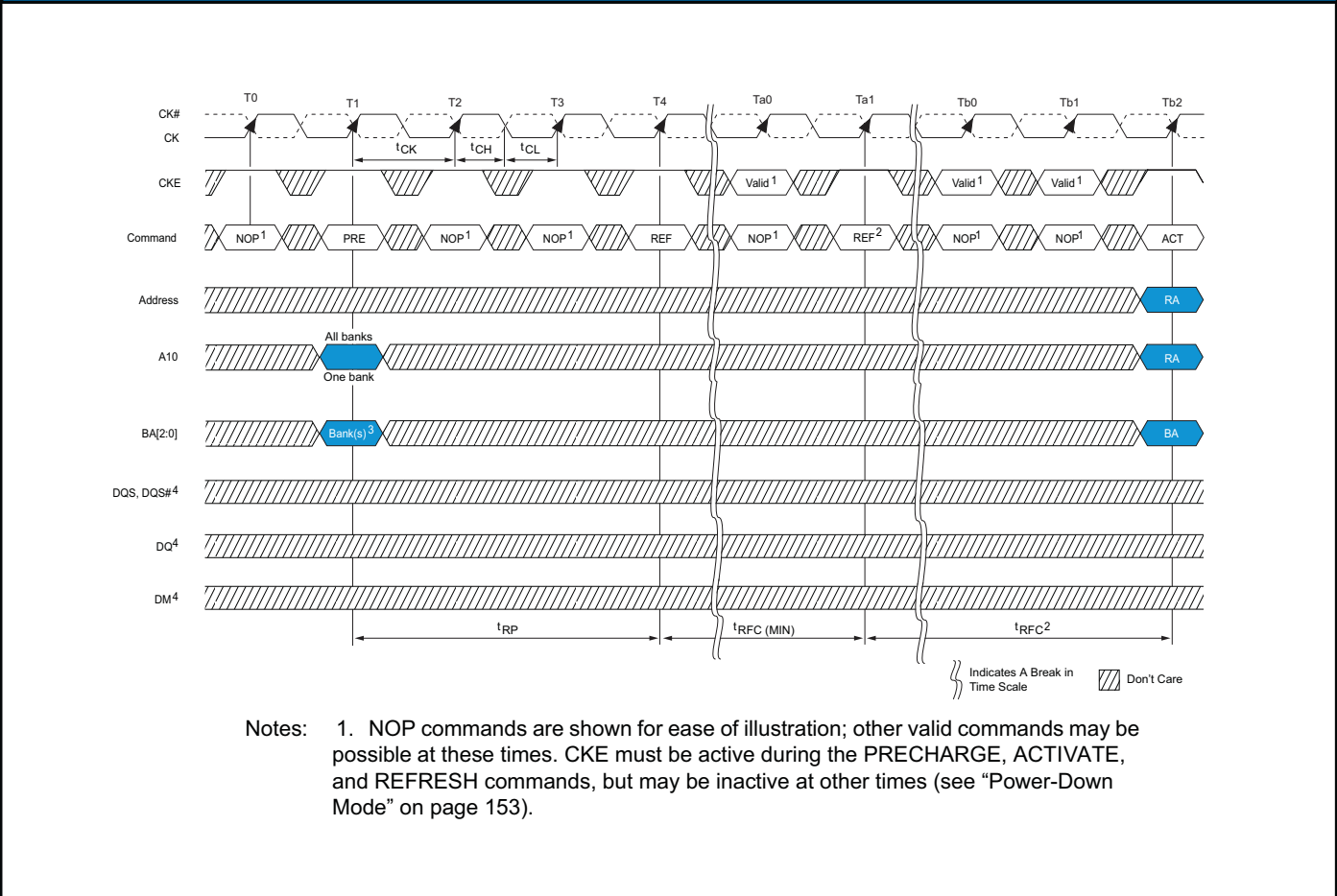
The PRECHARGE command is used to DEACTIVATE the open row in a particular bank or in all banks. The bank(s) are available for a subsequent row access at a specified time ( $t_{RP}$ ) after the PRECHARGE command is issued, except in the case of concurrent AUTO PRECHARGE. A READ or WRITE command to a different bank is allowed during concurrent AUTO PRECHARGE as long as it does not interrupt the data transfer in the current bank and does not violate any other timing parameters. Input A10 determines whether one or all banks are precharged. In the case where only one bank is recharged. Inputs BA[2:0] select the bank; otherwise, BA[2:0] are treated as "Don't Care". After a bank is PRECHARGED, it is in the idle state and must be activated prior to any READ or WRITE commands being issued to that bank. A PRECHARGE command is treated as a NOP if there is no open row in that bank (idle state) or if the previously open row is already in the process of precharging. However, the PRECHARGE period is determined by the last PRECHARGE command issued to the bank.

**REFRESH**

REFRESH is used during normal operation of the SDRAM and is analogous to CAS\before RAS\ (CBR) refresh or AUTO REFRESH. This command is non-persistent, so it must be issued each time a REFRESH is required. The addressing is generated by the internal REFRESH command. The SDRAM requires REFRESH cycles at an average interval of 7.8 $\mu$ s (maximum when  $T_A \leq 85^\circ\text{C}$  or 3.9 $\mu$ s MAX when  $T_A \leq 95^\circ\text{C}$ ). The REFRESH period begins when the REFRESH command is registered and ends  $t_{RFC}$  (MIN) later.

To allow for improved efficiency in scheduling and switching between tasks, some flexibility in the absolute REFRESH interval is provided. A maximum of eight REFRESH commands can be posted to any given SDRAM, meaning that the maximum absolute interval between any REFRESH command and the next REFRESH command is nine times the maximum average interval refresh rate. SELF REFRESH may be entered with up to eight REFRESH commands being posted. After exiting SELF REFRESH (when entered with posted REFRESH commands) additional posting of REFRESH commands is allowed to the extent the maximum number of cumulative posted REFRESH commands (both pre and post SELF REFRESH) does not exceed eight REFRESH commands.

**FIGURE 33 - REFRESH MODE**



Notes: 1. NOP commands are shown for ease of illustration; other valid commands may be possible at these times. CKE must be active during the PRECHARGE, ACTIVATE, and REFRESH commands, but may be inactive at other times (see "Power-Down Mode" on page 153).

## 16-32 Gb, DDR3, 256-512M x 32 Dual Channel Memory Module

### SELF REFRESH

The SELF REFRESH command is used to retain data in the SDRAM, even if the rest of the system is powered down. When in the SELF REFRESH mode, the SDRAM retains data without external clocking. The SELF REFRESH mode is also a convenient method used to enable/disable the DLL as well as to change the clock frequency within the allowed synchronous operating range. All power supply inputs (including VREFCA and VREFDQ) must be maintained at valid levels upon entry/exit and during SELF REFRESH mode operation. All power supply inputs (including VREFCA and VREFDQ) must be maintained at valid levels upon entry/exit and during SELF REFRESH mode under certain conditions:

- $V_{SS} < V_{REFDQ} < V_{DD}$  is maintained
- VREFDQ is valid and stable prior to CKE going back HIGH
- The first WRITE operation may not occur earlier than 512 clocks after VREFDQ is valid
- All other SELF REFRESH mode exit time requirements are met.

### DLL DISABLE MODE

If the DLL is disabled by the MODE REGISTER (MR1[0] can be switched during initialization or later), the SDRAM is targeted, but not guaranteed to operate similarly to the NORMAL mode with a few notable exceptions:

- The SDRAM supports only one value of CAS latency (CL=6) and one value of CAS WRITE latency (CWL=6).
- DLL DISABLE mode affects the READ data clock-to-data strobe relationship ( $t_{DQSCK}$ ), but not the READ data-to-data strobe relationship ( $t_{DQSQ}$ ,  $t_{QH}$ ). Special attention is needed to line the READ data up with the controller time domain when the DLL is disabled.
- In NORMAL operation (DLL on),  $t_{DQSCK}$  starts from the rising clock edge AL + CL cycles after the READ command. In DLL DISABLE mode,  $t_{DQSCK}$  starts AL = CL - 1 cycles after the READ command. Additionally, with the DLL disabled, the value of  $t_{DQSCK}$  could be larger than  $t_{CK}$ .

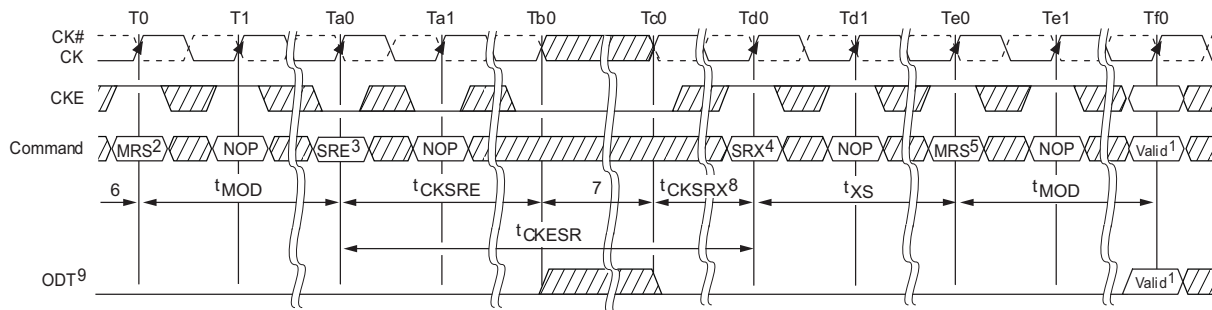
The ODT feature is not supported during DLL DISABLE mode (including dynamic ODT). The ODT resistors must be disabled by continuously registering the ODT ball LOW by programming RTT\_NORM MR1[9,6,2] and RTT\_WR MR2[10,9] to "0" while in DLL DISABLE mode.

Specific steps must be followed to switch between the DLL enable and DLL DISABLE modes due to a gap in the allowed clock rates between the two modes ( $t_{CK[AVG]MAX}$  and  $t_{CK[DLL\ DISABLE]MIN}$ , respectively). The only time the clock is allowed to cross this clock rate gap is during SELF REFRESH mode. Thus, the required procedure for switching from the DLL ENABLE to DLL DISABLE mode is to change frequency during self refresh (see Figure 34):

1. Starting from the IDLE state (all banks are PRECHARGED, all timings are fulfilled, ODT is turned off, and RTT\_NOM and RTT\_WR are HIGH-Z), set MR1[0] to "1" to DISABLE the DLL.
2. Enter SELF REFRESH mode after  $t_{MOD}$  has been satisfied.
3. After  $t_{CKSRE}$  is satisfied, change the frequency to the desired clock rate.
4. SELF REFRESH may be exited when the clock is stabilized with the new frequency for  $t_{CKSRX}$ .
5. The SDRAM will be ready for its next command in the DLL DISABLE mode after the greater of  $t_{MRD}$  or  $t_{MOD}$  has been satisfied. A ZQCL command should be issued with appropriate timing met as well.

**16-32 Gb, DDR3, 256-512M x 32 Dual Channel Memory Module**

**FIGURE 34 - DLL ENABLE MODE TO DLL DISABLE MODE**



**NOTES:**

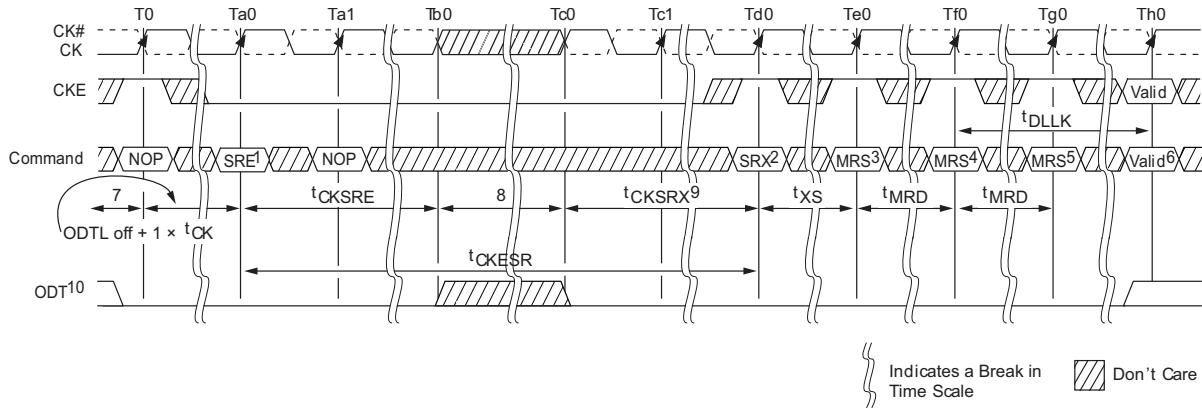
1. Any valid command.
2. Disable DLL by setting MR1[0] to "1."
3. Wait  $t_{XS}$ , then set MR1[0] to "0" to enable DLL.
4. Wait  $t_{MRD}$ , then set MR0[8] to "1" to begin DLL RESET.
5. Wait  $t_{MRD}$ , update registers (CL, CWL, and write recovery may be necessary).
6. Wait  $t_{MOD}$ , any valid command.
7. Starting with the idle state.
8. Change frequency.
9. Clock must be stable at least  $t_{CKSRX}$ .
10. Static LOW in case RTT\_NOM or RTT\_WR is enabled; otherwise, static LOW or HIGH.

A similar procedure is required for switching from the DLL disable mode back to the DLL enable mode. This also requires changing the frequency during self refresh mode (see Figure 44 on page 101).

1. Starting from the idle state (all banks are precharged, all timings are fulfilled, ODT is turned off, and RTT\_NOM and RTT\_WR are High-Z), enter self refresh mode.
2. After  $t_{CKSRE}$  is satisfied, change the frequency to the new clock rate.
3. Self refresh may be exited when the clock is stable with the new frequency for  $t_{CKSRX}$ . After  $t_{XS}$  is satisfied, update the mode registers with the appropriate values. At a minimum, set MR1[0] to "0" to enable the DLL. Wait  $t_{MRD}$ , then set MR0[8] to "1" to enable DLL RESET.
4. After another  $t_{MRD}$  delay is satisfied, then update the remaining mode registers with the appropriate values.
5. The DRAM will be ready for its next command in the DLL enable mode after the greater of  $t_{MRD}$  or  $t_{MOD}$  has been satisfied. However, before applying any command or function requiring a locked DLL, a delay of  $t_{DLLK}$  after DLL RESET must be satisfied. A ZQCL command should be issued with the appropriate timings met as well.

**16-32 Gb, DDR3, 256-512M x 32 Dual Channel Memory Module**

**FIGURE 35- DLL DISABLE MODE TO DLL ENABLE MODE**



**NOTES:**

1. Enter SELF REFRESH.
2. Exit SELF REFRESH.
3. Wait  $t_{XS}$ , then set MR1[0] to "0" to enable DLL.
4. Wait  $t_{MRD}$ , then set MR0[8] to "1" to begin DLL RESET.
5. Wait  $t_{MRD}$ , update registers (CL, CWL, and write recovery may be necessary).
6. Wait  $t_{MOD}$ , any valid command.
7. Starting with the idle state.
8. Change frequency.
9. Clock must be stable at least  $t_{CKSRX}$ .
10. Static LOW in case RTT\_NOM or RTT\_WR is enabled; otherwise, static LOW or HIGH.

The clock frequency range for the DLL disable mode is specified by the parameter  $t_{CKDLL\_DIS}$ . Due to latency counter and timing restrictions, only CL = 6 and CWL = 6 are supported.

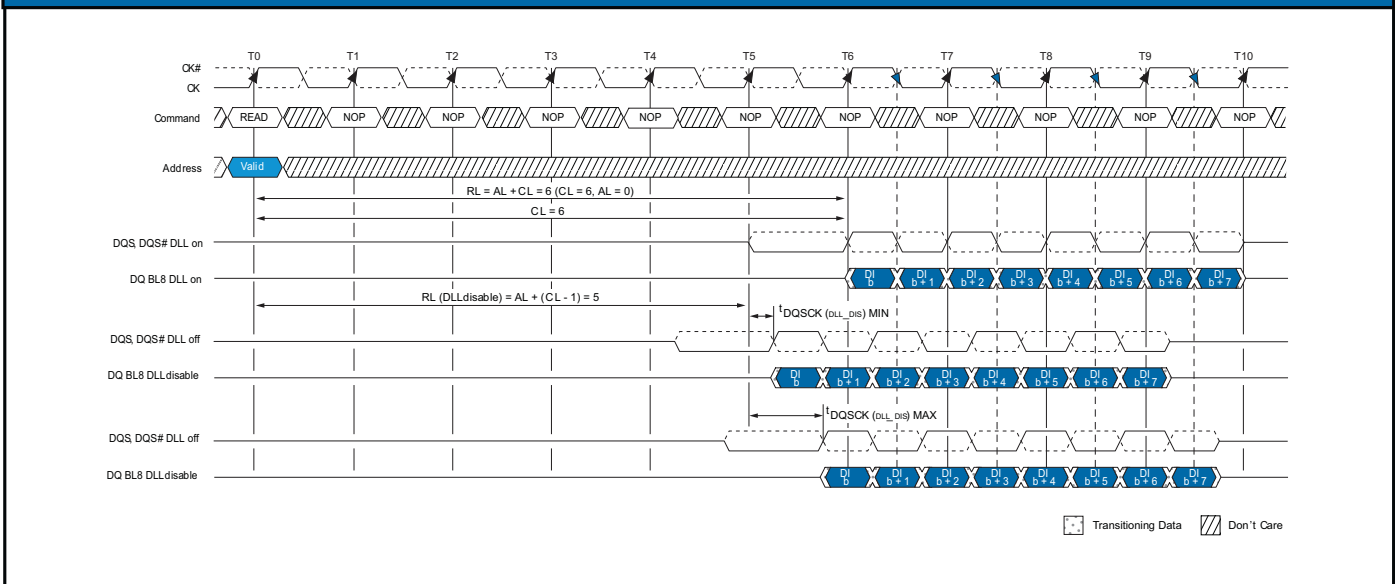
DLL disable mode will affect the read data clock to data strobe relationship ( $t_{DQSCK}$ ) but not the data strobe to data relationship ( $t_{DQSQ}$ ,  $t_{QH}$ ). Special attention is needed to the controller time domain.

Compared to the DLL on mode where  $t_{DQSCK}$  starts from the rising clock edge AL + CL cycles after the READ command, the DLL disable mode  $t_{DQSCK}$  starts AL + CL - 1 cycles after the READ command (see Figure 45 on page 102).

WRITE operations function similarly between the DLL enable and DLL disable modes; however, ODT functionality is not allowed with DLL disable mode.

**16-32 Gb, DDR3, 256-512M x 32 Dual Channel Memory Module**

**FIGURE 36 - DLL DISABLE <sup>t</sup>DQ<sub>SCK</sub> TIMING**



**INPUT CLOCK FREQUENCY CHANGE**

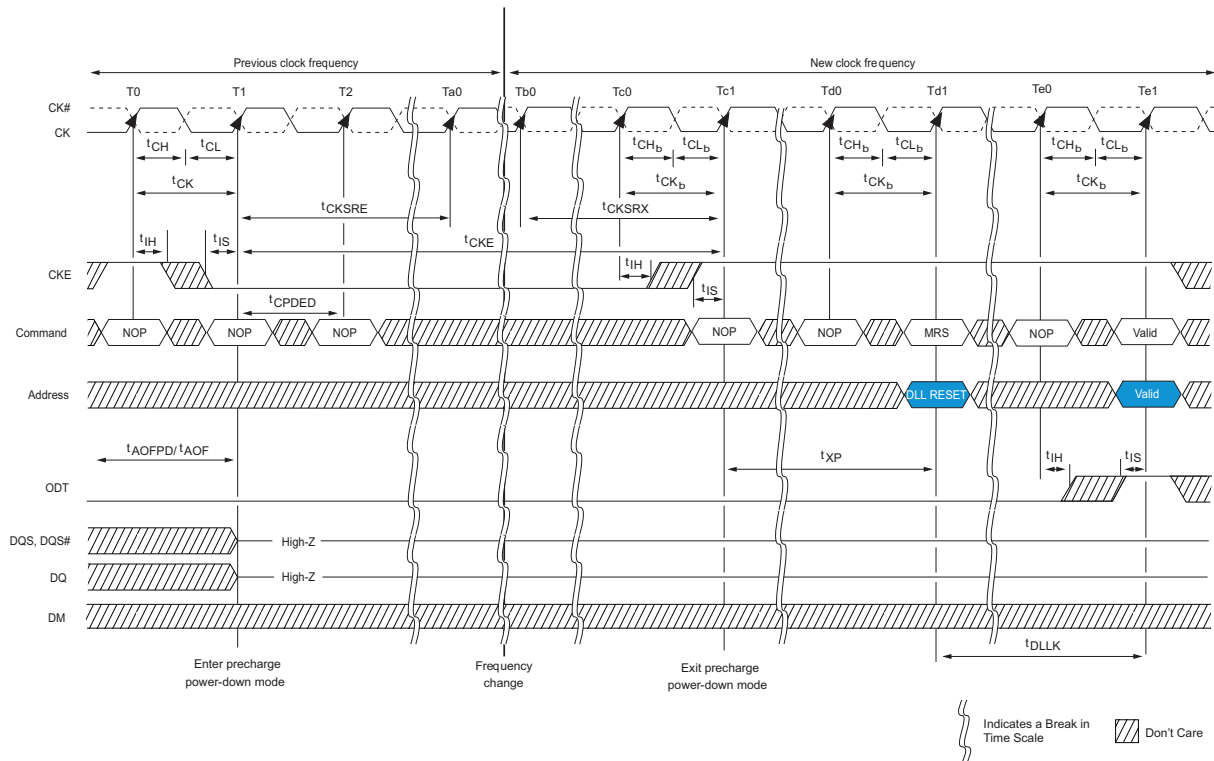
When the DDR3 SDRAM is initialized, it requires the clock to be stable during most NORMAL states of operation. This means that after the clock frequency has been set to the stable state, the clock period is not allowed to deviate except what is allowed for by the clock jitter and spread spectrum clocking (SSC) specifications.

The input clock frequency can be changed from one stable clock rate to another under two conditions: SELF REFRESH mode and PRECHARGE power-down mode. Outside of these two modes, it is illegal to change the clock frequency. For the SELF REFRESH mode condition, when the DDR3 SDRAM has been successfully placed into SELF REFRESH mode and <sup>t</sup>CKSRE has been satisfied, the state of the clock becomes a "Don't Care". When the clock becomes a "Don't Care", changing the clock frequency is permissible, provided the new clock frequency is stable prior to <sup>t</sup>CKSRX. When entering and exiting self refresh mode for the sole purpose of changing the clock frequency, the SELF REFRESH entry and exit specifications must still be met.

The PRECHARGE power-down mode condition is when the DDR3 SDRAM is in PRECHARGE power-down mode (either fast exit mode or slow exit mode). Either ODT must be at a logic LOW or RTT\_NOM and RTT\_WR must be disabled via MR1 and MR2. This ensures RTT\_NOM and RTT\_WR are in an off state prior to entering PRECHARGE power-down mode while maintaining CKE at a logic LOW. A minimum of <sup>t</sup>CKSRE must occur after CKE goes LOW before the clock frequency can change. The DDR3 SDRAM input clock frequency is allowed to change only within the minimum and maximum operating frequency specified for the particular speed/temperature grade (<sup>t</sup>CK [AVG] MIN to <sup>t</sup>CK [AVG] MAX) device. During the input clock frequency change, CKE must be held at a stable LOW level. When the input clock frequency is changed, a stable clock must be provided to the SDRAM, <sup>t</sup>CKSRX before PRECHARGE power-down may be exited. After PRECHARGE power-down is exited and <sup>t</sup>XP has been satisfied, the DLL must be reset via the MRS. Depending on the new clock frequency, additional MRS commands may need to be issued. During the DLL lock time, RTT\_NOM and RTT\_WR must remain in an off state. After the DLL lock time, the SDRAM is ready to operate with a new clock frequency (period). This process is depicted in Figure 37.

**16-32 Gb, DDR3, 256-512M x 32 Dual Channel Memory Module**

**FIGURE 37- CHANGE FREQUENCY DURING PRECHARGE POWER-DOWN**



**NOTES:**

1. Applicable for both slow-exit and fast-exit precharge power-down modes.
2.  $t_{AOFPD}$  and  $t_{AOF}$  must be satisfied and outputs High-Z prior to T1 (see “On-Die Termination (ODT)” on page 162 for exact requirements).
3. If the  $RTT\_NOM$  feature was enabled in the mode register prior to entering precharge power-down mode, the ODT signal must be continuously registered LOW ensuring RTT is in an off state. If the  $RTT\_NOM$  feature was disabled in the mode register prior to entering precharge power-down mode, RTT will remain in the off state. The ODT signal can be registered either LOW or HIGH in this case.



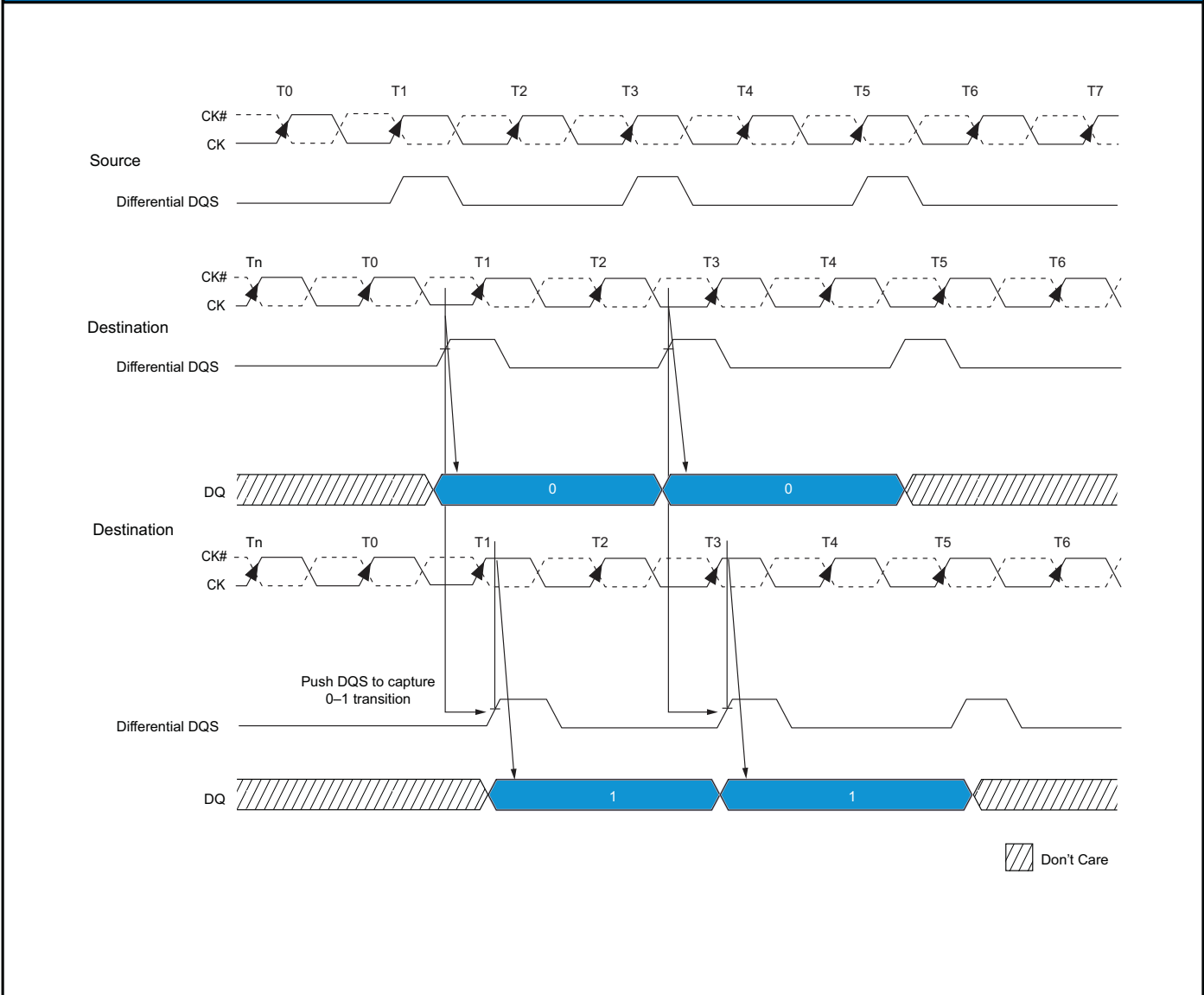
**16-32 Gb, DDR3, 256-512M x 32 Dual Channel Memory Module**

**WRITE LEVELING**

For better signal integrity, DDR3 SDRAM memory sub-system designs have adopted use of fly-by topology for the commands, addresses, control signals and clocks. WRITE leveling is a scheme for the memory controller to de-skew the DQSx strobe (DQSx, DQSx) to CK relationship at the SDRAM with a simple feedback feature provided it by the DDR3 SDRAM itself. WRITE leveling is generally used as part of the initialization process, if required. For NORMAL SDRAM operation, this feature must be disabled. This is the only SDRAM operation where the DQS functions as an input (to capture the incoming clock) and the DQs function as outputs (to report the stat of the clock). Note that nonstandard ODT schemes are required.

The memory controller using the WRITE leveling procedure must have adjustable delay setting on its DQS strobe to align the rising edge of DQS to the clock at the SDRAM pins. This is accomplished when the SDRAM asynchronously feeds back the CK status via the DQ bus and samples with the rising edge of DQS. The controller repeatedly delays the DQS strobe until a CK transition from "0" to "1" is detected. The DQS delay established through this procedure helps ensure 'DQSS, 'DSS, and 'DSH specifications in systems that use fly by topology by de-skewing the trace length mismatch. A conceptual timing of this procedure is shown in Figure 38.

**FIGURE 38- WRITE LEVELING CONCEPT**



## 16-32 Gb, DDR3, 256-512M x 32 Dual Channel Memory Module

### WRITE LEVELING

When WRITE leveling is enabled, the rising edge of DQS samples CK and the rime DQ outputs the sampled CK's status. The prime DQ for each of the (4) words contained in the iMOD is DQ0 for the low byte, DQ8 for the high byte. It outputs the status of CK sampled by LDQSx and UDQSx. All other DQs (DQ[7:1], DQ[15:9] for the low word, DQ[23:17], DQ[31:25] for the next word, DQ[39:33], DQ[47:41] for the next and DQ[55:49], DQ[63:57] for the HIGH word) continue to drive LOW. Two prime DQ on each of the (4) words contained in the LDI iMOD allow each byte lane to be leveled independently.

### WRITE LEVELING PROCEDURE

A memory controller initiates the SDRAM WRITE Leveling mode by setting the MR1[7] to a "1", assuming the other programmable features (MR0, MR1, MR2, and MR3) are first set and the DLL is fully reset and locked. The DQ balls enter the WRITE Leveling mode going from a "HIGH-Z" state to an undefined driving state so the DQ bus should not be driven. During WRITE Leveling mode, only the NOP and DES commands are allowed. The memory controller should attempt to level only one rank at a time; thus, the outputs of other ranks should be disabled by setting MR1[12] to a "1". The memory controller may assert ODT after a <sup>t</sup>MOD delay as the SDRAM will be ready to process the ODTL on delay (WL-2<sup>t</sup>CK), provided it does not violate the aforementioned <sup>t</sup>MOD delay requirement.

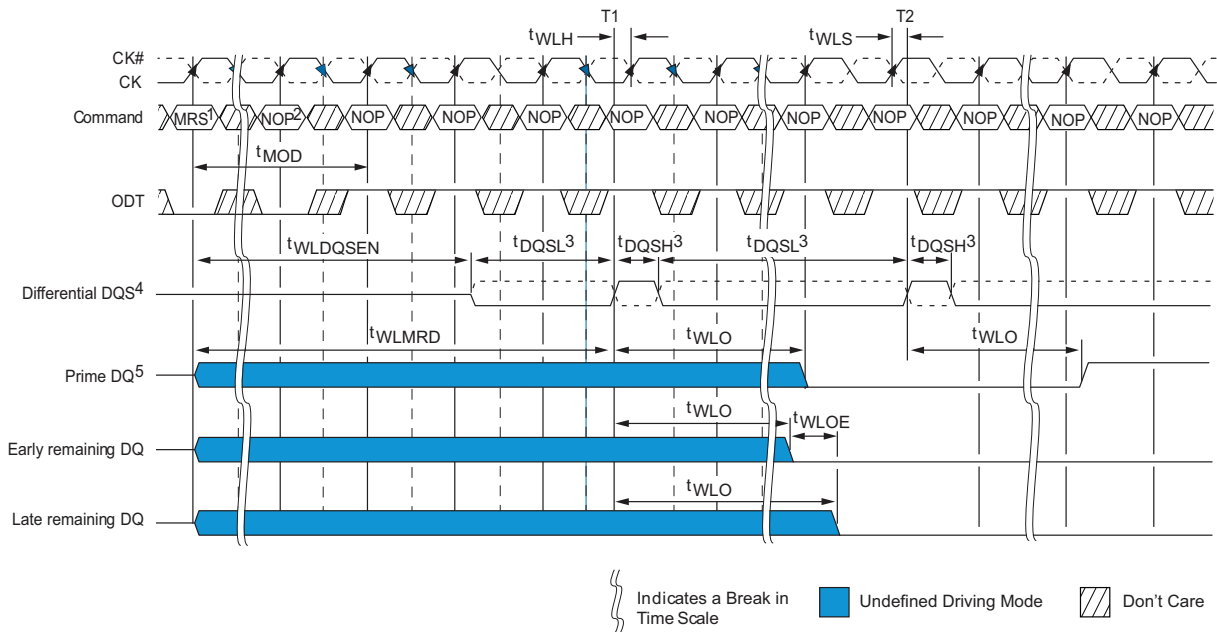
The memory controller may drive LDQSx, UDQSx LOW and LDQSx\, UDQSx\ HIGH after <sup>t</sup>WLDQSEN has been satisfied. The controller may begin to toggle LDQSx, UDQSx after <sup>t</sup>WLMRD (one L[U]DQSs toggle is DQSs transitioning from a LOW state to a HIGH state with L[U]DQSx\ transitioning from a HIGH state to a LOW state, then both transition back to their original states). At a minimum, ODTL on and <sup>t</sup>AON must be satisfied at least one clock prior to DQS toggling.

After <sup>t</sup>WLMRD and DQS LOW preamble (<sup>t</sup>WPRE) have been satisfied, the memory controller may provide either a single DQSx toggle or multiple DQSx toggles to sample CK for a given DQSx to CK skew. Each DQS toggle must not violate <sup>t</sup>DQSL (MIN) and <sup>t</sup>DQSH (MIN) specifications. <sup>t</sup>DQSL (MAX) and <sup>t</sup>DQSH (MAX) specifications are not applicable during WRITE leveling mode. The DQSx must be able to distinguish the CK's rising edge within <sup>t</sup>WLS and <sup>t</sup>WLH. The prime DQ will output the CK's status asynchronously from the associated DQSx rising edge CK capture within <sup>t</sup>WLO. The remaining DQs that always drive LOW when DQS is toggling must be LOW within <sup>t</sup>WLOE after the first <sup>t</sup>WLO is satisfied (the prime DQs going LOW). As previously noted, DQSx is an input and not an output during this process. Figure 39 depicts the basic timing parameters for the overall write leveling procedure.

The memory controller will likely sample each applicable prime DQ state and determine whether to increment or decrement its DQS delay setting. After the memory controller performs enough DQSx toggles to detect the CK's "0-1" transition, the memory controller should lock the DQS delay setting for the SDRAM iMOD device. After locking the DQS setting, leveling for the rank will have been achieved, and the WRITE leveling mode for the rank should be disabled or reprogrammed (if WRITE leveling of another rank follows).

**16-32 Gb, DDR3, 256-512M x 32 Dual Channel Memory Module**

**FIGURE 39- WRITE LEVELING SEQUENCE**



**NOTES:**

1. MRS: Load MR1 to enter write leveling mode.
2. NOP: NOP or DES.
3. DQS, DQS# needs to fulfill minimum pulse width requirements  $t_{DQSH}$  (MIN) and  $t_{DQSL}$  (MIN) as defined for regular writes. The maximum pulse width is system-dependent.
4. Differential DQS is the differential data strobe (DQS, DQS#). Timing reference points are the zero crossings. The solid line represents DQS; the dotted line represents DQS#.
5. DRAM drives leveling feedback on a prime DQ (DQ0 for x4 and x8). The remaining DQ are driven LOW and remain in this state throughout the leveling procedure.

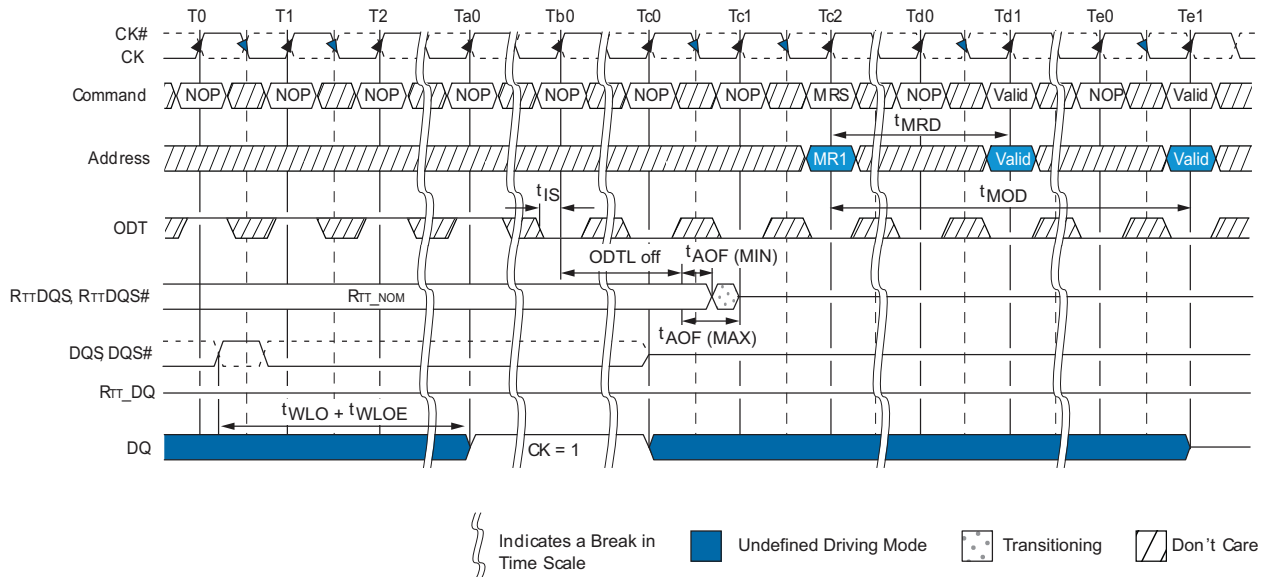
**WRITE LEVELING EXIT MODE**

After the DDR3 SDRAM iMOD has been WRITE leveled, the controller must exit from WRITE Leveling mode before the NORMAL mode can be used. Figure 40 depicts a general procedure in exiting WRITE Leveling. After the last rising DQS (capturing a “1” at T0), the memory controller should stop driving the DQS signals after  $t_{WLO}$  (MAX) delay plus enough delay to enable the memory controller to capture the applicable prime DQ state (at  $-Tb0$ ). The DQ balls become undefined when DQS no longer remains LOW and they remain undefined until  $t_{MOD}$  after the MRS command (at Te1).

The ODT input should be deasserted LOW such that ODTL off (MIN) expires after the DQSx is no longer driving LOW. When ODT LOW satisfies  $t_{IS}$ , ODT must be kept LOW (at  $-Tb0$ ) until the SDRAM is ready for either another rank to be leveled or until the NORMAL mode can be used. After DQS termination is switched off, WRITE level mode should be disabled via the MRS command (at TA2). After  $t_{MOD}$  is satisfied (at Te1), any valid command may be registered by the SDRAM. Some MRS commands may be issued after  $t_{MRD}$  (at Td1).

**16-32 Gb, DDR3, 256-512M x 32 Dual Channel Memory Module**

**FIGURE 40- EXIT WRITE LEVELING**



Notes: 1. The DQ result, “= 1,” between Ta0 and Tc0, is a result of the DQS, DQS# signals capturing CK HIGH just after the T0 state.

## 16-32 Gb, DDR3, 256-512M x 32 Dual Channel Memory Module

### OPERATIONS

#### Initialization

The following sequence is required for power up and initialization, as shown in Figure 41.

1. Apply power. RESET $\bar$  is recommended to be below  $0.2 \times V_{DDQ}$  during power ramp to ensure the outputs remain disabled (HIGH-Z) and ODT off (RTT is also HIGH-Z). All other inputs, including ODT may be undefined.

During power up, either of the following conditions may exist and must be met:

• **Condition A:**

- $V_{DD}$  and  $V_{DDQ}$  are driven from a single power source and are ramped with a maximum delta voltage between them of  $\Delta V \leq 300\text{mV}$ . Slope reversal of any power supply signal is allowed. The voltage levels on all balls other than  $V_{DD}$ ,  $V_{DDQ}$ ,  $V_{SS}$  and  $V_{SSQ}$  must be less than or equal to  $V_{DDQ}$  and  $V_{DD}$  on one side and must be greater than or equal to  $V_{SSQ}$  and  $V_{SS}$  on the other side.
- Both  $V_{DD}$  and  $V_{DDQ}$  power supplies ramp to  $V_{DD}$  (MIN) and  $V_{DDQ}$  (MIN) within  $t_{VDDPR}=200\text{ms}$ .
- Both  $V_{DD}$  and  $V_{DDQ}$  power supplies ramp to  $V_{DD}$  (MIN) and  $V_{DDQ}$  (MIN) within  $t_{VDDPR}=200\text{ms}$ .
- VREFDQ tracks  $V_{DD} \times 0.5$ , VREFCA tracks  $V_{DD} \times 0.5$ .
- $V_{TT}$  is limited to 0.95V when the power ramp is complete and is not applied directly to the device; however,  $t_{VTD}$  should be greater than or equal to zero to avoid device latchup.

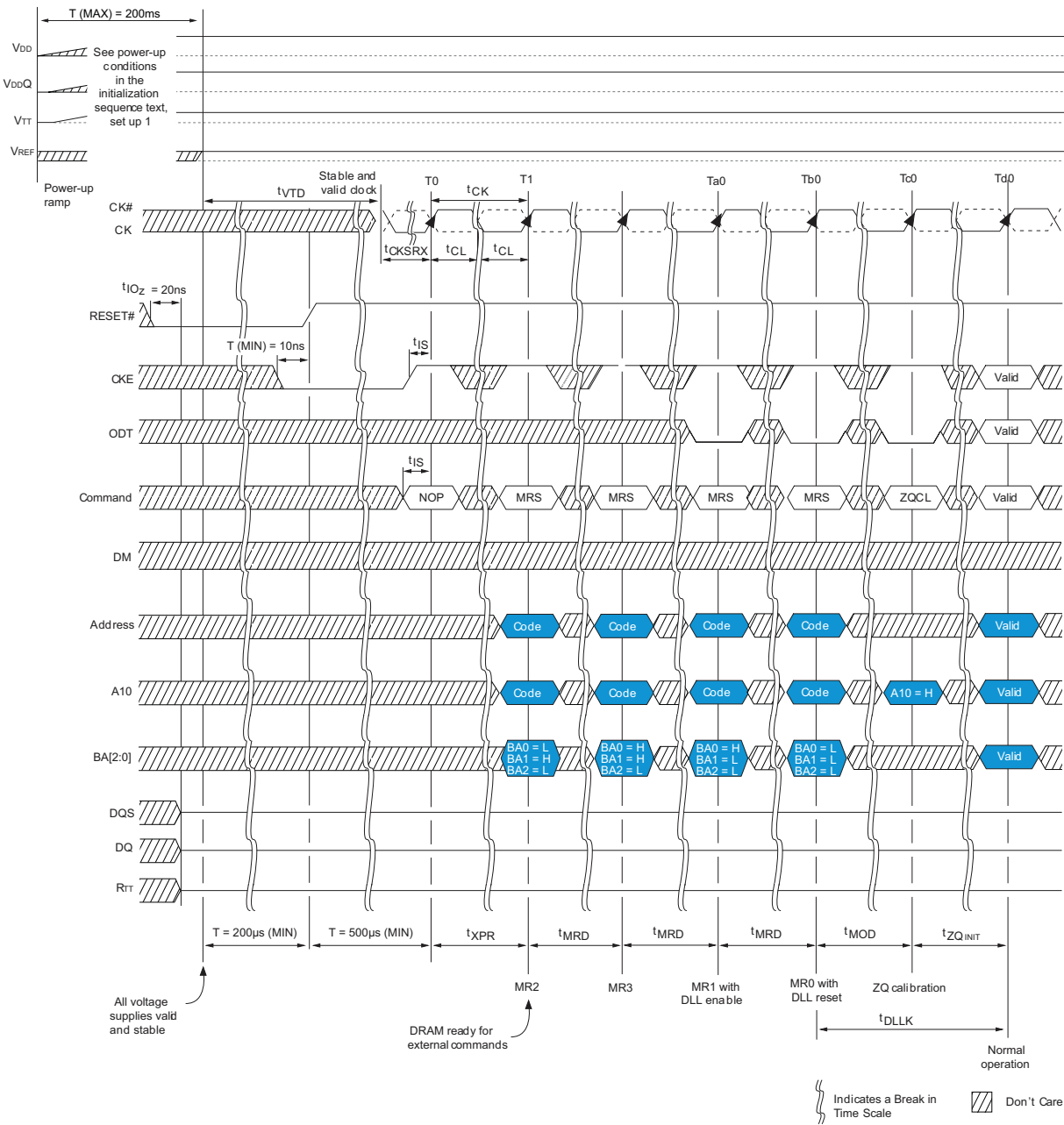
• **Condition B:**

- $V_{DD}$  may be applied before or at the same time as  $V_{DDQ}$ .
- $V_{DDQ}$  may be applied before or at the same time as  $V_{TT}$ , VREFDQ and VREFCA.
- No slope reversals are allowed in the power supply ramp for this condition.

2. Until stable power, maintain RESET $\bar$  LOW to ensure the outputs remain disabled (HIGH-Z). After the power is stable, RESET $\bar$  must be LOW for at least 200 $\mu\text{s}$  to begin the initialization process. ODT will remain in the HIGH-Z state while RESET $\bar$  is LOW and until CKE is registered HIGH.
3. CKE must be LOW 10ns prior to RESET $\bar$  transitioning HIGH.
4. After RESET $\bar$  transitions HIGH, wait 500 $\mu\text{s}$  (minus one clock) with CKE LOW.
5. After this CKE LOW time, CKE may be brought HIGH (synchronously) and only NOP or DES commands may be issued. The clock must be present and valid for at least 10ns (and a minimum of five clocks) and ODT must be driven LOW at least  $t_{IS}$  prior to CKE being registered HIGH. When CKE is registered HIGH, it must be continuously registered HIGH until the full initialization process is complete.
6. After CKE is registered HIGH and after  $t_{XPR}$  has been satisfied, MRS commands may be issued. Issue an MRS (LOAD MODE) command to MR2 with the applicable settings (provide LOW to BA2 and BA0 and HIGH to BA1).
7. Issue an MRS command to MR3 with the applicable settings.
8. Issue an MRS command to MR1 with the applicable settings, including enabling the DLL and configuring ODT.
9. Issue and MRS command to MR0 with the applicable settings, including a DLL RESET command.  $t_{DLLK}$  (512) cycles of clock input are required to lock the DLL.
10. Issue a ZQCL command to calibrate RTT and RON values for the process voltage temperature (PVT). Prior to NORMAL operation.  $t_{ZQINIT}$  must be satisfied.
11. When  $t_{DLLK}$  and  $t_{ZQINIT}$  have been satisfied, the DDR3 SDRAM will be ready for normal operation.

**16-32 Gb, DDR3, 256-512M x 32 Dual Channel Memory Module**

**FIGURE 41- INITIALIZATION SEQUENCE**



**16-32 Gb, DDR3, 256-512M x 32 Dual Channel Memory Module**

**MODE REGISTERS**

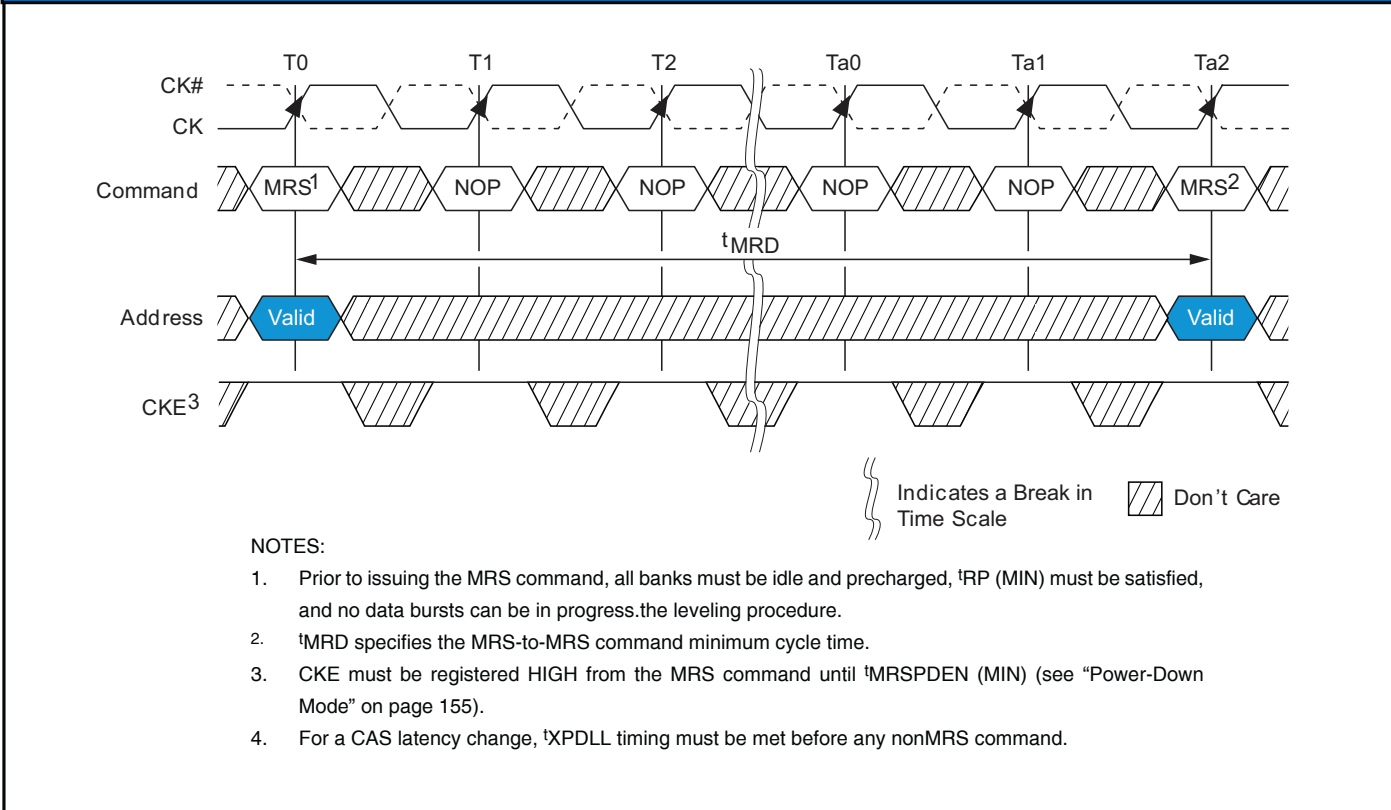
Mode registers (MR0-MR3) are used to define various modes of programmable operation of the DDR3 SDRAM iMOD. A mode register is programmed via the MODE REGISTER SET (MRS) command during initialization and it retains the stored information (except for MR0[8] which is self-clearing) until it is either reprogrammed, RESET\ goes LOW, or until the device loses power.

Contents of a mode register can be altered by re-executing the MRS command. If the user chooses to modify only a subset of the mode register's variables, all variables must be programmed when the MRS command is issued. Reprogramming the mode register will not alter the contents of the memory array, provided it is performed correctly.

The MRS command can only be issued (or re-issued) when all banks are idle and in the PRECHARGED state (TRP is satisfied and no data bursts are in progress). After an MRS command has been issued, two parameters must be satisfied: tMRD and tMOD.

The controller must wait tMRD before initiating any subsequent MRS commands (see Figure 42).

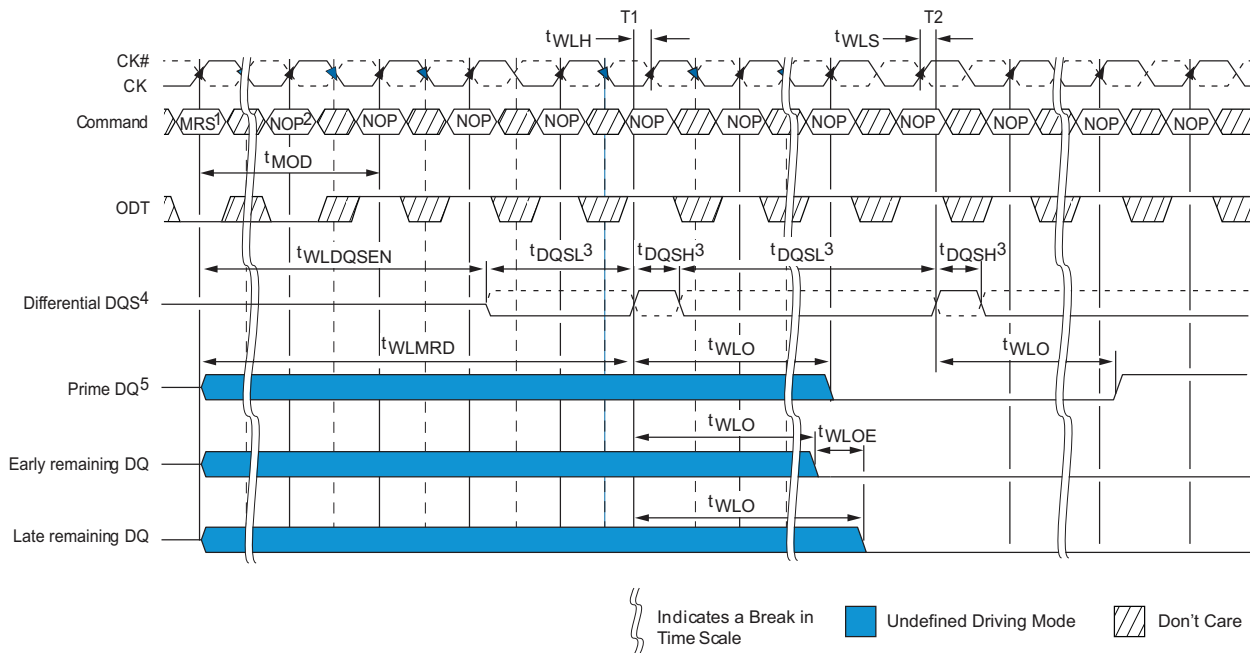
**FIGURE 42- MRS-TO-MRS COMMAND TIMING (tMRD)**



The controller must also wait tMOD before initiating any nonMRS commands (excluding NOP and DES), as shown in Figure 52 on page 112. The DRAM requires tMOD in order to update the requested features, with the exception of DLL RESET, which requires additional time. Until tMOD has been satisfied, the updated features are to be assumed unavailable.

**16-32 Gb, DDR3, 256-512M x 32 Dual Channel Memory Module**

**FIGURE 43- MRS-TO-NONMRS COMMAND TIMING ( $t_{MOD}$ )**



**NOTES:**

1. Prior to issuing the MRS command, all banks must be idle (they must be precharged,  $t_{RP}$  must be satisfied, and no data bursts can be in progress).
2. Prior to  $Ta2$  when  $t_{MOD}$  (MIN) is being satisfied, no commands (except NOP/DES) may be issued.
3. If RTT was previously enabled, ODT must be registered LOW at  $T0$  so that  $ODTL$  is satisfied prior to  $Ta1$ . ODT must also be registered LOW at each rising CK edge from  $T0$  until  $t_{MOD}$  (MIN) is satisfied at  $Ta2$ .
4. CKE must be registered HIGH from the MRS command until  $t_{MRSPDEN}$  (MIN), at which time power-down may occur (see "Power-Down Mode" on page 134).

**MODE REGISTER 0 (MR0)**

The base register, MR0 is used to define various DDR3 iMOD modes of operation. These definitions include the selection of a burst length, burst type, CAS latency, operating mode, DLL RESET, WRITE recovery and PRECHARGE power-down mode, as shown in Figure 44.



**16-32 Gb, DDR3, 256-512M x 32 Dual Channel Memory Module**

**MODE REGISTER 0 (MR0)**

**BURST TYPE**

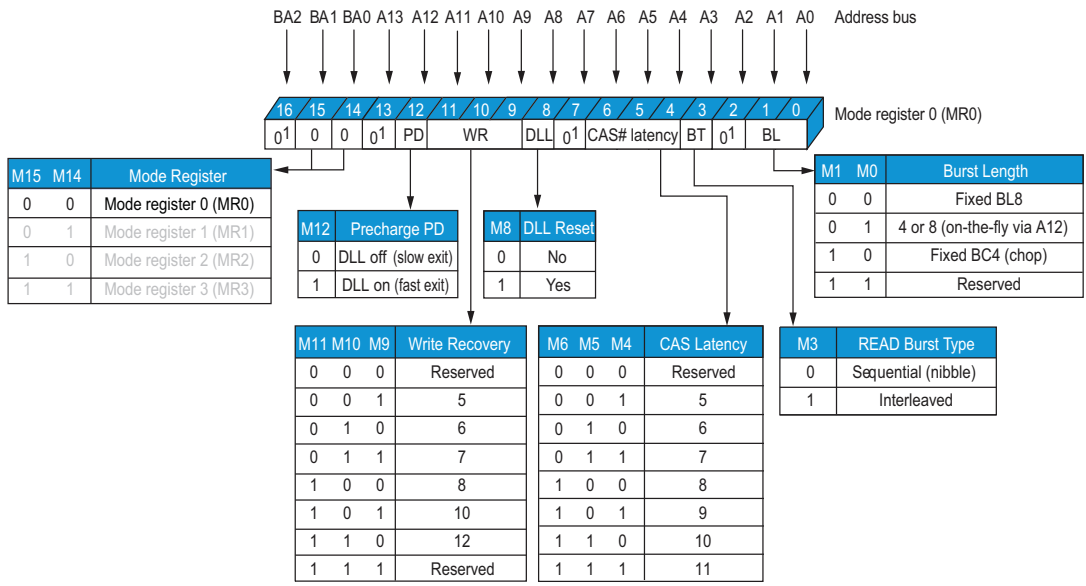
Accesses within a given burst may be programmed to either a sequential or an interleaved order. The burst type is selected via MR0[3], as shown in Figure 44. The ordering of accesses within a burst is determined by the burst length, the burst type and the starting column address, as shown in Table 60. DDR3 only supports 4-bit burst chop and 8-bit burst access modes. Full interleaved address ordering is supported for READs, while WRITEs are restricted to nibble (BC4) or word (BL8) boundaries.

**BURST LENGTH**

Burst length is defined by MR0[1:0] (see Figure 44). READ and WRITE accesses to the DDR3 SDRAM iMOD are burst-oriented, with the burst length being programmable to “4” (chop mode), “8” (fixed burst), or selectable using A12 during a READ/WRITE command (on the fly). The burst length determines the maximum number of column locations that can be accessed for a given READ or WRITE command. When MR0[1:0] is set to “01” during a READ/WRITE command, if A12=0, then BC4 (chop) mode is selected. If A12=1, then BL8 mode is selected. Specific timing diagrams, and turnaround between READ/WRITE are shown in the READ/WRITE sections of this document.

When a READ or WRITE command is issued, a block of columns equal to the burst length is effectively selected. All accesses for that burst take place within this block, meaning that the burst will wrap within the block if a boundary is reached. The block is uniquely selected by A[i:2] when the burst length is set to “4” and by A[i:3] when the burst length is set to “8” (where Ai is the most significant column address bit for a given starting location within the block. The programmed burst length applies to both READ and WRITE bursts.

**FIGURE 44- MODE REGISTER 0 (MR0) DEFINITIONS**



Notes: 1. MR0[16, 13, 7, 2] are reserved for future use and must be programmed to “0.”

## 16-32 Gb, DDR3, 256-512M x 32 Dual Channel Memory Module

**TABLE 60: BURST ORDER**

Burst Length	Read/Write	Starting Column Address (A[2,1,0])	Burst Type (Decimal)		Notes
			Type = Sequential	Type = Interleaved	
4 CHOP	READ	0 0 0	0,1,2,3,Z,Z,Z,Z	0,1,2,3,Z,Z,Z,Z	1,2
		0 0 1	1,2,3,0,Z,Z,Z,Z	1,0,3,2,Z,Z,Z,Z	1,2
		0 1 0	2,3,0,1,Z,Z,Z,Z	2,3,0,1,Z,Z,Z,Z	1,2
		0 1 1	3,0,1,2,Z,Z,Z,Z	3,2,1,0,Z,Z,Z,Z	1,2
		1 0 0	4,5,6,7,Z,Z,Z,Z	4,5,6,7,Z,Z,Z,Z	1,2
		1 0 1	5,6,7,4,Z,Z,Z,Z	5,4,7,6,Z,Z,Z,Z	1,2
		1 1 0	6,7,4,5,Z,Z,Z,Z	6,7,4,5,Z,Z,Z,Z	1,2
		1 1 1	7,4,5,6,Z,Z,Z,Z	7,6,5,4,Z,Z,Z,Z	1,2
	WRITE	0 V V	0,1,2,3,X,X,X,X	0,1,2,3,X,X,X,X	1,3,4
		1 V V	4,5,6,7,X,X,X,X	4,5,6,7,X,X,X,X	1,3,4
8	READ	0 0 0	0,1,2,3,4,5,6,7	0,1,2,3,4,5,6,7	1
		0 0 1	1,2,3,0,5,6,7,4	1,0,3,2,5,4,7,6	1
		0 1 0	2,3,0,1,6,7,4,5	2,3,0,1,6,7,4,5	1
		0 1 1	3,0,1,2,7,4,5,6	3,2,1,0,7,6,5,4	1
		1 0 0	4,5,6,7,0,1,2,3	4,5,6,7,0,1,2,3	1
		1 0 1	5,6,7,4,1,2,3,0	5,4,7,6,1,0,3,2	1
		1 1 0	6,7,4,5,2,3,0,1	6,7,4,5,2,3,0,1	1
		1 1 1	7,4,5,6,3,0,1,2	7,6,5,4,3,2,1,0	1
	WRITE	V V V	0,1,2,3,4,5,6,7	0,1,2,3,4,5,6,7	1,3

**NOTES:**

- Internal READ and WRITE operations start at the same point in time for BC4 as they do for BL8.
- Z = Data and Strobe output drivers in tri-state.
- X="Don't Care"

### DLL RESET

DLL RESET is defined by MR0[8] (see Figure 44). Programming MR0[8] to "1" activates the DLL RESET function. MR0[8] is self-clearing, meaning it returns to a value of "0" after the DLL RESET function has been initiated.

Anytime the DLL RESET function has been initiated, CKE must be HIGH and the clock held stable for 512 (<sup>t</sup>DLLK) clock cycles before a READ command can be issued. This is to allow time for the internal clock to be synchronized with the external clock. Failing to wait for synchronization to occur may result in invalid output timing specifications such as <sup>t</sup>DQSCK timings.

### WRITE RECOVERY

WRITE RECOVERY time is defined by MR0[11:9] (see Figure 44). WRITE RECOVERY values of 5,6,7,8,10 or 12 may be used by programming MR0[11:9]. The user is required to program the correct value of WRITE RECOVERY and is calculated by dividing <sup>t</sup>WR (ns) by <sup>t</sup>CK (ns) and rounding up a non-integer value to the next integer: WR (cycles)=roundup (<sup>t</sup>WR[ns]/<sup>t</sup>CK [ns]).

**16-32 Gb, DDR3, 256-512M x 32 Dual Channel Memory Module**

**PRECHARGE POWER-DOWN (PRECHARGE PD)**

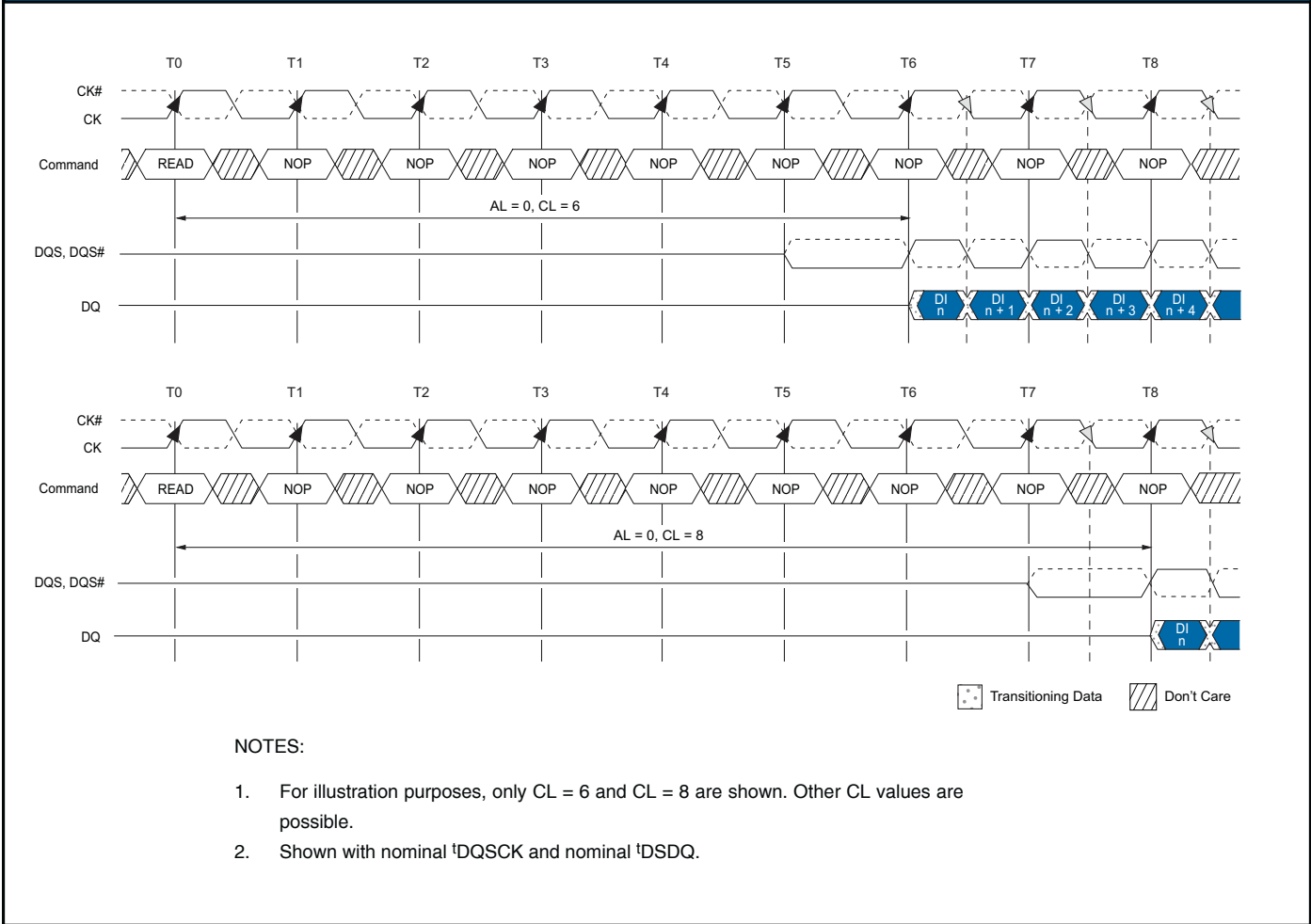
The PRECHARGE PD bit applies only when PRECHARGE power-down mode is being used. When MR0[12] is set to "0", the DLL is off during PRECHARGE power-down providing a lower standby current mode; however, <sup>1</sup>XPDLL must be satisfied when exiting. When MR0[12] is set to "1", the DLL continues to run during PRECHARGE power-down mode to enable a faster exit of PRECHARGE power-down mode; however, <sup>1</sup>XP must be satisfied when exiting (see Power-Down mode on Page 134).

**CAS Latency (CL)**

The CL is defined by MR0[6:4], as shown in Figure 44. CAS latency is the delay, as measured in clock cycles, between the internal READ command and the availability of the first bit of valid output data. The CL can be set to 5, 6, 8, or 10. DDR3 SDRAM iMODS do not support half-clock latencies.

Examples of CL=6 and CL=8 are shown in Figure 45 (below). If an internal READ command is registered at clock edge n, and the CAS latency is m clocks, the data will be available nominally coincident with clock edge n+m. Table 46 indicates the CLs supported at available operating frequencies.

**FIGURE 45- READ LATENCY**



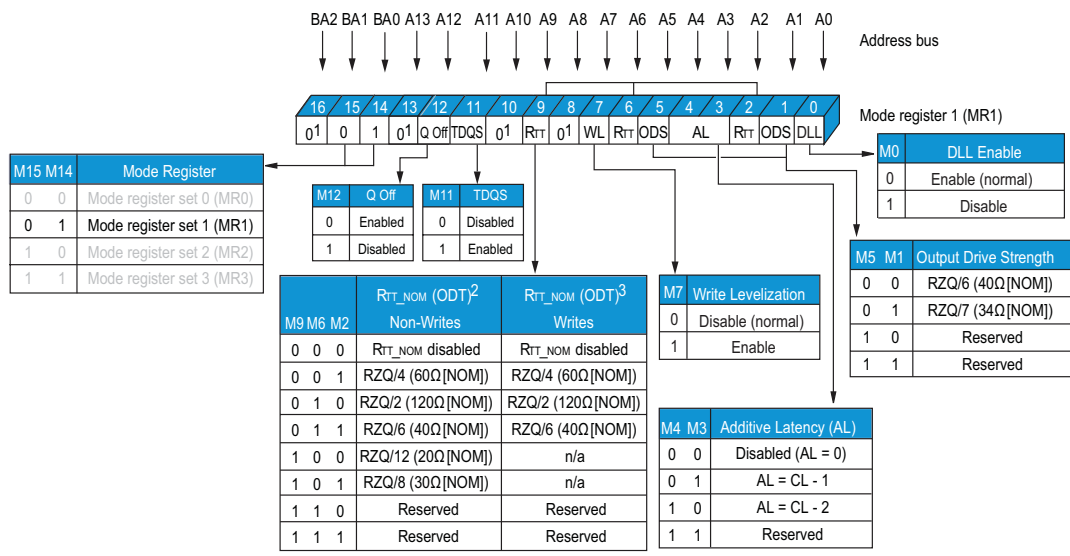
**16-32 Gb, DDR3, 256-512M x 32 Dual Channel Memory Module**

**MODE REGISTER 1 (MR1)**

The MODE REGISTER 1 (MR1) controls additional functions and features not available in the other mode registers; Q OFF (OUTPUT DISABLE), DLL ENABLE/DLL DISABLE, RTT\_NOM value (ODT), WRITE LEVELING, POSTED CAS ADDITIVE latency, and OUTPUT DRIVE STRENGTH. These functions are controlled via the bits shown in Figure 46 below. The MR1 register is programmed via the MR5 command and retains the stored information until it is reprogrammed, until RESET goes LOW (true), or until the device loses power. Reprogramming the MR1 register will not alter the contents of the memory array, provided the operation is performed correctly.

The MR1 register must be loaded when all banks are idle and no bursts are in progress. The controller must satisfy the specified timing parameters <sup>1</sup>MRD and <sup>1</sup>MOD before initiating a subsequent operation.

**FIGURE 46- MODE REGISTER 1 (MR1) DEFINITION**



**NOTES:**

- MR1[16, 13, 10, 8] are reserved for future use and must be programmed to "0."
- During write leveling, if MR1[7] and MR1[12] are "1" then all RTT\_NOM values are available for use.
- During write leveling, if MR1[7] is a "1," but MR1[12] is a "0," then only RTT\_NOM write values are available for use.

## 16-32 Gb, DDR3, 256-512M x 32 Dual Channel Memory Module

### DLL ENABLE/DLL DISABLE

The DLL may be enabled or disabled by programming MR1[0] during the LOAD MODE command, as shown in Figure 46 (previous page). The DLL must be enabled for NORMAL operation. DLL ENABLE is required during power-up initialization and upon returning to NORMAL operation after having DISABLED the DLL for the purpose of debugging or evaluation. ENABLING the DLL should always be followed by resetting the DLL using the appropriate LOAD MODE command.

If the DLL is enabled prior to entering SELF REFRESH mode, the DLL is automatically DISABLED when entering SELF REFRESH operation and is automatically RE-ENABLED and RESET upon exit of SELF REFRESH. If the DLL is DISABLED prior to entering SELF REFRESH, the DLL remains DISABLED even upon exit of the SELF REFRESH operation until it has been RE-ENABLED and RESET.

The SDRAM is not tested, nor does LDI warrant compliance with NORMAL mode timings or functionality when the DLL is disabled. An attempt has been made for the SDRAM to operate in the NORMAL mode whenever possible when the DLL is disabled; however, by industry standards, the following exceptions have been observed, defined and listed:

1. ODT is NOT ALLOWED to be used
2. The OUTPUT DATA is no longer edge-aligned to the clock
3. CL and CWL can only be six clocks

When the DLL is DISABLED, timing and functionality can vary from the NORMAL operational specifications when the DLL is enabled. DISABLING the DLL also implies the need to change the clock frequency.

### OUTPUT DRIVE STRENGTH

The DDR3 SDRAM iMOD uses a programmable impedance output buffer. The drive strength mode register setting is defined by MR1[5:1], RZQ/7 (34Ω [NOM]) is the primary output driver impedance setting for the device. To calibrate the output driver impedance, and external precision resistor (RZQ) is connected between the ZQ ball and VssQ. The value of the resistor is 240Ω±1%.

The output impedance is set during initialization. Additional impedance calibration updates do not affect device operation and all data sheet timings and current specifications are met during an update.

To meet the 34Ω specification, the output drive strength must be set to 34Ω during initialization. To obtain a calibrated output driver impedance after power-up, the DDR3 iMOD SDRAM needs a calibration command that is part of the initialization and reset procedure.

### OUTPUT ENABLE/DISABLE

The OUTPUT ENABLE function is defined by MR1[12], as shown in Figure 46. When enabled (MR1[12]=0), all outputs (DQx, DQSx, DQSx) are tri-stated. The output DISABLE feature is intended to be used during I<sub>DDQ</sub> characterization of the READ current and during t<sub>1DQSS</sub> margining (WRITE LEVELING) only.

### ON-DIE TERMINATION (ODT)

ODT resistance R<sub>TT\_NOM</sub> is defined by MR1[9,6,2] (see Figure 46). The R<sub>TT</sub> termination value applies to the DQx, LDMx, UDMx, L[U]DQSx and L[U]DQSx. The DDR3 device architecture supports multiple R<sub>TT</sub> termination values based on RZQ/n where n can be 3,4,6,8 or 12 and RZQ is 240Ω.

Unlike DDR2, DDR3 ODT must be turned off prior to READING data out and must remain off during READ burst. R<sub>TT\_NOM</sub> termination is allowed any time after the DRAM is initialized, calibrated, and not performing READ accesses, or in SELF REFRESH mode. Additionally, WRITE accesses with dynamic ODT enabled (R<sub>TT\_WR</sub>) temporarily replaces R<sub>TT\_NOM</sub> with R<sub>TT\_WR</sub>.

The actual effective termination, R<sub>TT\_EFF</sub>, may be different from the R<sub>TT</sub> targeted value due to non-linearity of the termination. For R<sub>TT\_EFF</sub> values and calculations, see the ON-DIE TERMINATION (ODT) description later in this DS.

The ODT feature is designed to improve signal integrity of the memory device by enabling the DDR3 SDRAM controller to independently turn ON/OFF ODT for any or all devices in the end designs array. The ODT input control pin is used to determine when R<sub>TT</sub> is turned on (ODTLon) and off (ODTLoff), assuming ODT has been ENABLED via MR1[9,6,2].

Timings for ODT are detailed in the “ON-DIE Termination (ODT)” description later in this DS.

### WRITE LEVELING

The WRITE LEVELING function is enabled by MR1[7], as shown in Figure 46, WRITE LEVELING is used (during initialization) to de-skew the DQSx strobe to clock offset as a result of fly-by topology designs. For better signal integrity, some end use designs of DDR3 devices adopted fly-by topology for the commands, addresses, control signals and clocks.

The fly-by topology benefits from a reduced number of stubs and their lengths, however, fly-by topology induces flight time skew between the clock and DQSx strobe (and DQx) at each SDRAM in the array. Controllers will have a difficult time maintaining t<sub>1DQSS</sub>, t<sub>1DSS</sub> and t<sub>1DSH</sub> specifications without supporting WRITE LEVELING in systems which use fly-by topology based designs. WRITE LEVELING timing and detailed operation information is provided in “WRITE LEVELING”.

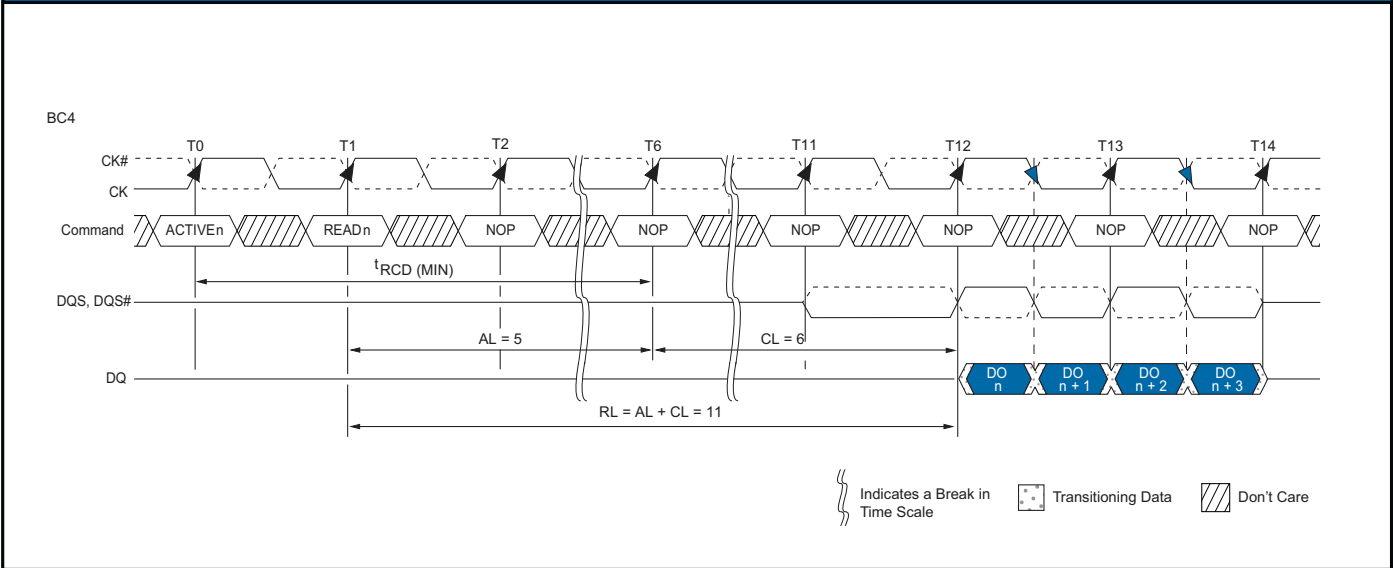
**16-32 Gb, DDR3, 256-512M x 32 Dual Channel Memory Module**

**POSTED CAS ADDITIVE LATENCY (AL)**

AL is supported to make the command and data bus efficient for sustainable bandwidths in DDR3 SRAMs. MR1[4,3] define the value of AL (see Figure 46). MR1[4,3] enables the user to program the DDR3 SDRAM with an AL=0, CL-1, or CL-2.

With this feature, the DDR3 SDRAM enables a READ or WRITE command to be issued after the ACTIVATE command for that bank prior to  $t_{RCD(MIN)}$ . The only restriction is ACTIVATE to READ or WRITE + AL  $\geq t_{RCD(MIN)}$  must be satisfied. Assuming  $t_{RCD(MIN)} = CL$ , a typical application using this feature, sets  $AL=CL - 1t_{CK} = t_{RCD(MIN)} - 1t_{CK}$ . The READ or WRITE command is held for the time of the AL before it is released internally to the DDR3 SDRAM iMOD device. READ latency (RL) is controlled by the sum of the AL and CAS latency (CL),  $RL=AL+CL$ , WRITE latency (WL) is the sum of CAS WRITE latency and AL,  $WL=AL + CWL$  (see "MODE REGISTER 2 (MR2)"). Examples of READ and WRITE latencies are shown in Figure 47 and Figure 49.

**FIGURE 47- READ LATENCY (AL = 5, CL = 6)**

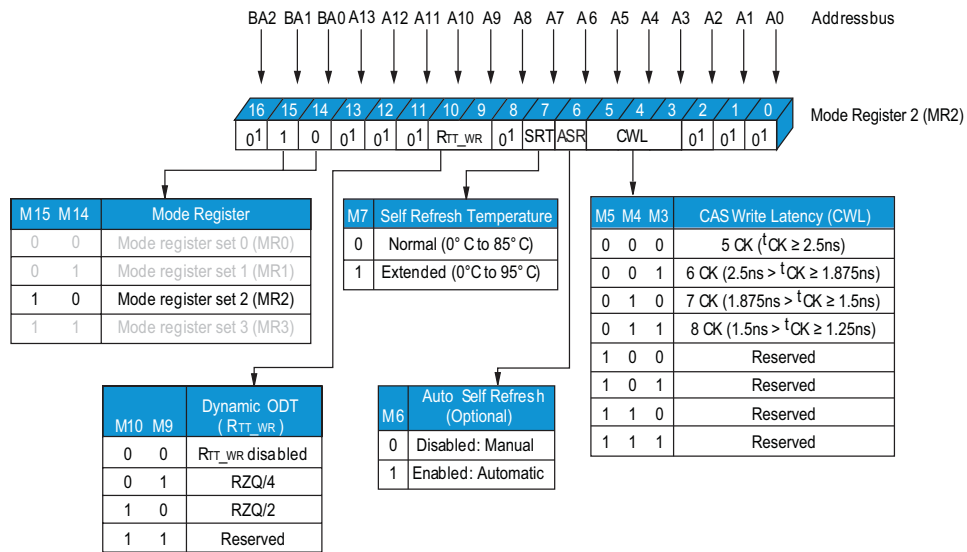


**16-32 Gb, DDR3, 256-512M x 32 Dual Channel Memory Module**

**MODE REGISTER 2 (MR2)**

The MODE REGISTER 2 (MR2) controls additional functions and features not available in the other mode registers. These additional functions are CAS WRITE latency (CWL), AUTO SELF REFRESH (ASR), SELF REFRESH TEMPERATURE (SRT) and DYNAMIC ODT (RTT\_WR). These functions are controlled via the bits shown in Figure 48. The MR2 is programmed via the MRS command and will retain the stored information until it is programmed again or until the device loses power. Reprogramming the MR2 register will not alter the contents of the memory array, provided that the operation has been performed correctly. The MR2 register must be loaded when all banks are idle and no data bursts are in progress and the memory controller must wait for the specified time tMRD and tMOD before initiating a subsequent operation.

**FIGURE 48- MODE REGISTER 2 (MR2) DEFINITION**



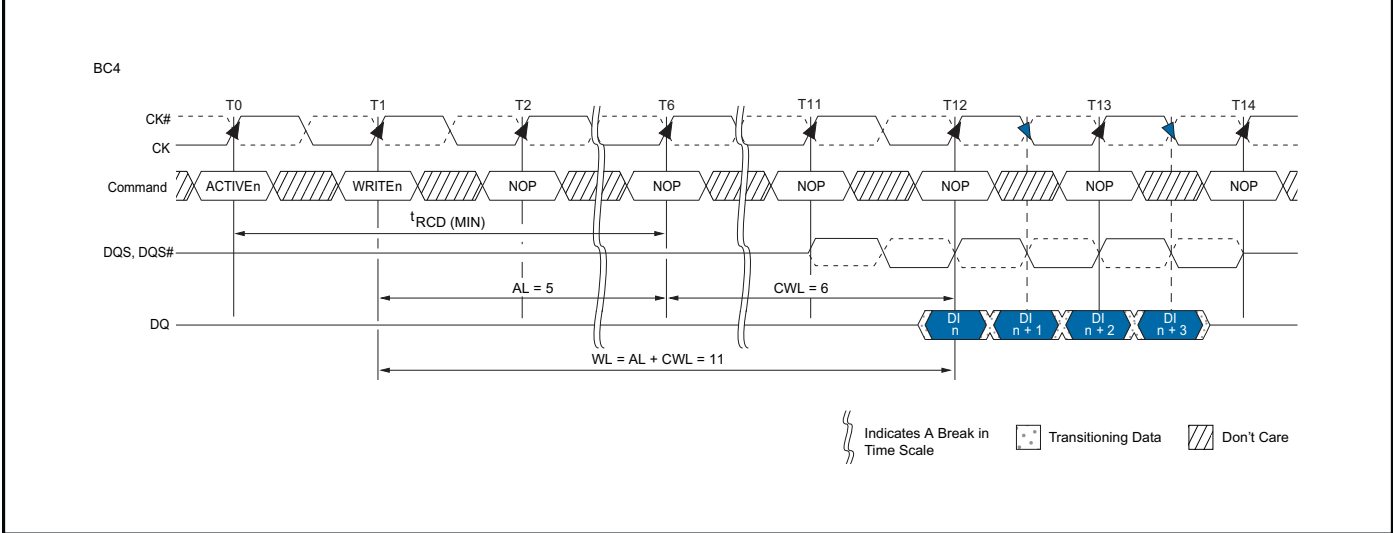
Notes: 1. MR2[16, 13:11, 8, and 2:0] are reserved for future use and must all be programmed to “0.”

**16-32 Gb, DDR3, 256-512M x 32 Dual Channel Memory Module**

**CAS WRITE LATENCY (CWL)**

CWL is defined by MR2[5:3] and is the delay, in clock cycles, from the releasing of the internal WRITE to the latching of the first data in. CWL must be correctly set to the corresponding operating clock frequency (see Figure 48). The overall WRITE LATENCY (WL) is equal to CWL + AL (see Figure 46).

**FIGURE 49- CAS WRITE LATENCY**



**AUTO SELF REFRESH (ASR)**

Mode register MR2[6] is used to DISABLE/ENABLE the ASR function.

When ASR is DISABLED, the SELF REFRESH mode's REFRESH rate is assumed to be at the normal 85°C limit (commonly referred to as the 1X REFRESH rate). In the DISABLED mode, ASR requires the user to ensure the SDRAM never exceeds a TA of 85°C while in SELF REFRESH unless the user enables the SRT feature listed below, supporting an elevated temp up to +95°C while in SELF REFRESH.

The standard SELF REFRESH current test specifies test conditions to normal ambient temperature (85°C) only, meaning if ASR is enabled, the standard SELF REFRESH current specification does not apply (see the "EXTENDED TEMPERATURE USAGE" description later in this DS).

**SELF REFRESH TEMPERATURE (SRT)**

Mode register MR2[7] is used to DISABLE/ENABLE the SRT function. When SRT is Disabled, the SELF REFRESH mode's refresh rate is assumed to be at the normal 85°C limit. In the DISABLED mode, SRT requires the user to ensure the SDRAM never exceeds the TA limit of 85°C while in SELF REFRESH mode unless the user enables ASR.

When SRT is enabled, the SDRAM SELF REFRESH is changed internally from 1X to 2X, regardless of the ambient temperature (TA). This enables the user to operate the SDRAM beyond the standard 85°C limit up to the

optional extended temperature range of +95°C while in SELF REFRESH mode. The standard SELF REFRESH current test specifies test conditions to normal ambient temperature (85°C) only, meaning if SRT is enabled, the standard SELF REFRESH current specifications do not apply.

**SRT vs. ASR**

If the normal ambient temperature limit of 85°C is not exceeded, then neither SRT nor ASR is required, and both can be DISABLED throughout operation. If the extended temperature option is used, the user is required to provide a 2X refresh rate during (manual) refresh for Extended temp devices or 3X refresh rate for Mil-temp devices. SRT and ASR should be enabled for automatic REFRESH services on all devices used in temperature environments ≤95°C

SRT forces the SDRAM to switch the internal SELF REFRESH rate from 1X to 2X. SELF REFRESH is performed at 2X regardless of TA.

ASR automatically switches the SDRAM's internal SELF REFRESH rate from 1X to 2X, however, while in SELF REFRESH mode, ASR enables the REFRESH rate automatically adjust between 1X and 2X REFRESH rate over the supported temperature range. One other disadvantage with ASR is the SDRAM cannot always switch from a 1X to a 2X refresh rate at an exact ambient Temperature of 85°C. Although the SDRAM will support data integrity when it switches from a 1X to 2X rate, it may switch at a lower temperature than 85°C.

Since only one mode is necessary at one instant in time, SRT and ASR cannot be simultaneously enabled.



**16-32 Gb, DDR3, 256-512M x 32 Dual Channel Memory Module**

**DYNAMIC ODT**

The dynamic ODT (RTT\_WR) feature is defined by MR2[10,9]. Dynamic ODT is enabled when a value is selected. This new DDR3 feature enables the ODT termination value to change without issuing an MRS command, essentially changing the ODT termination “on-the-fly”.

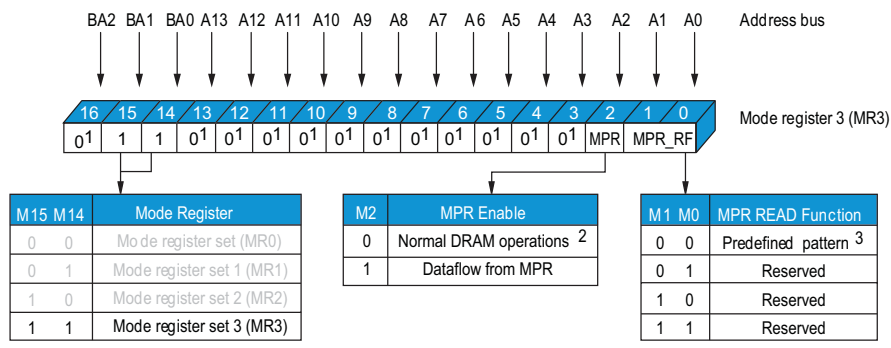
With dynamic ODT (RTT\_WR) when beginning a WRITE burst and subsequently switches back to ODT (RTT\_WR) is enabled: ODTLCNW, ODTLCNW4, ODTLCNW\* ODTH4, ODTH8 and tADC.

Dynamic ODT is only applicable during WRITE cycles, If ODT (RTT\_NOM) is disabled, dynamic ODT (RTT\_WR) is still permitted. RTT\_NOM and RTT\_WR can be used independent of one another. Dynamic ODT is not available during WRITE LEVELING mode, regardless of the state of ODT (RTT\_NOM). For details on ODT operation, refer to the “On-Die-Termination (ODT)” section.

**MODE REGISTER (MR3)**

The mode register 3 (MR3) controls additional functions and features not available via MR0, MR1 or MR2. Currently defined as the MULTIPURPOSE REGISTER (MPR). This function is controlled via the bits shown in Figure 50. The MR3 is programmed via the LOAD MODE command and retains the stored information until it is programmed again or until the device loses power. Reprogramming the MR3 register will not alter the contents of the memory array, provided the programming of the MR3 has been performed correctly. The MR3 register must be loaded when all banks are idle and no data bursts are in progress and the memory controller must wait the specified time tMRD and tMOD before initiating a subsequent operation.

**FIGURE 50 - MODE REGISTER 3 (MR3) DEFINITION**



**NOTES:**

- MR3[16 and 13:4] are reserved for future use and must all be programmed to “0.”
- When MPR control is set for normal DRAM operation, MR3[1, 0] will be ignored.
- Intended to be used for READ synchronization.

**16-32 Gb, DDR3, 256-512M x 32 Dual Channel Memory Module**

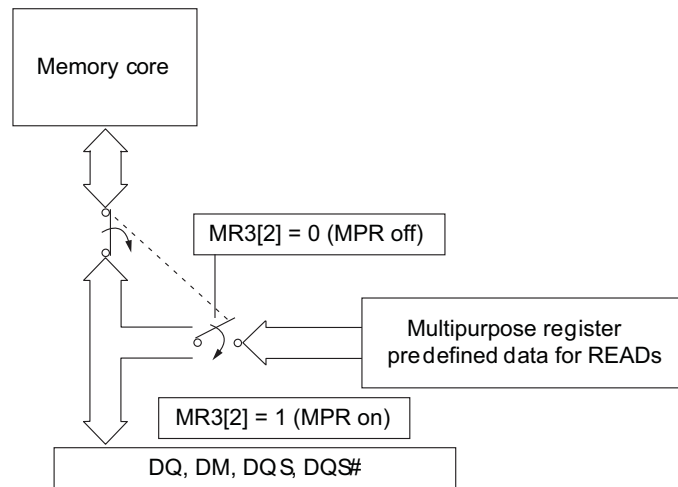
**MULTIPURPOSE REGISTER (MPR)**

The MULTIPURPOSE REGISTER function is used to output a predefined system timing calibration bit sequence. Bit 2 is the master bit that enables or disables access to the MPR register and bits 1 and 0 determine which mode the MPR is placed in. The basic concept of the multipurpose register is shown in Figure 51.

If MR3[2] is a "0", then the MPR access is disabled and the SDRAM operates in normal mode. However, if MR3[2] is a "1", then SDRAM no longer outputs normal read data but outputs MPR data as defined by MR3[0,1]. If MR3[0,1] is equal to "00", then a predefined read pattern for system calibration is selected.

To enable the MPR, the MRS command is issued to MR3 and MR3[2]=1 (see Table 61). Prior to issuing the MRS command, all banks must be in the idle state (all banks are precharged, and tRP is met). When the MPR is enabled, any subsequent READ or RDAP commands are redirected to the multipurpose register. The resulting operation when either a READ or a RDAP command is issued is defined by MR3[1:0] when MPR is enabled (see Table 62). When the MPR is enabled, only READ or RDAP commands are allowed until a subsequent MRS command is issued with the MPR disabled (MR3[2]=0). POWER-DOWN, SELF REFRESH and any other NON READ or RDAP command is not allowed. The RESET function is supported during MPR enable mode.

**FIGURE 51 - MULTIPURPOSE REGISTER (MPR) BLOCK DIAGRAM**



**NOTES:**

1. A predefined data pattern can be read out of the MPR with an external READ command.
2. MR3[2] defines whether the data flow comes from the memory core or the MPR. When the data flow is defined, the MPR contents can be read out continuously with a regular READ or RDAP command.

## 16-32 Gb, DDR3, 256-512M x 32 Dual Channel Memory Module

**TABLE 61: BURST ORDER**

MR3[2] MPR	MR3[1:0] MPR READ Function	Function
0	"Don't Care"	Normal Operation, no MPR transaction. All subsequent READs come from the SDRAM memory array. All subsequent WRITES go to the SDRAM memory array.
1	A[1:0] (See Table 67)	Enable MPR mode, subsequent READ/RDAP commands defined by bits 1 and 2.

### MPR FUNCTIONAL DESCRIPTION

The MPR JEDEC definition allows for either a prime DQ0 for lower byte and DQ8 for the upper byte of each of the (4) words contained in the LDI iMOD, to output the MPR data with the remaining DQs driven LOW, or for all DQs to output the MPR data. The MPR readout supports fixed READ burst and READ burst chop (MRS and OTF via A12/BC#) with regular READ latencies and AC timings applicable. This providing the DLL is locked as required.

MPR addressing for a valid MPR READ is as follows:

- A[1:0] must be set to "00" as the burst order is fixed per nibble
- A2 selects the burst order
  - BL8, A2 is set to "0", and the burst order is fixed to 0,1,2,3,4,5,6,7
- For burst chop 4 cases, the burst order is switched on the nibble base and:
  - A2=0: burst order =0,1,2,3
  - A2=1: burst order =4,5,6,7
- Burst order bit 0 (the first bit) is assigned to LSB, and burst order bit 7 (the last bit) is assigned to MSB
- A[9:3] are a "Don't Care"
- A10 is a "Don't Care"
- A11 is a "Don't Care"
- A12: Selects burst chop mode on-the-fly, if enabled within MR0
- A13 is a "Don't Care"
- BA[2:0] are a "Don't Care"

## 16-32 Gb, DDR3, 256-512M x 32 Dual Channel Memory Module

### MPR REGISTER ADDRESS DEFINITIONS and BURSTING ORDER

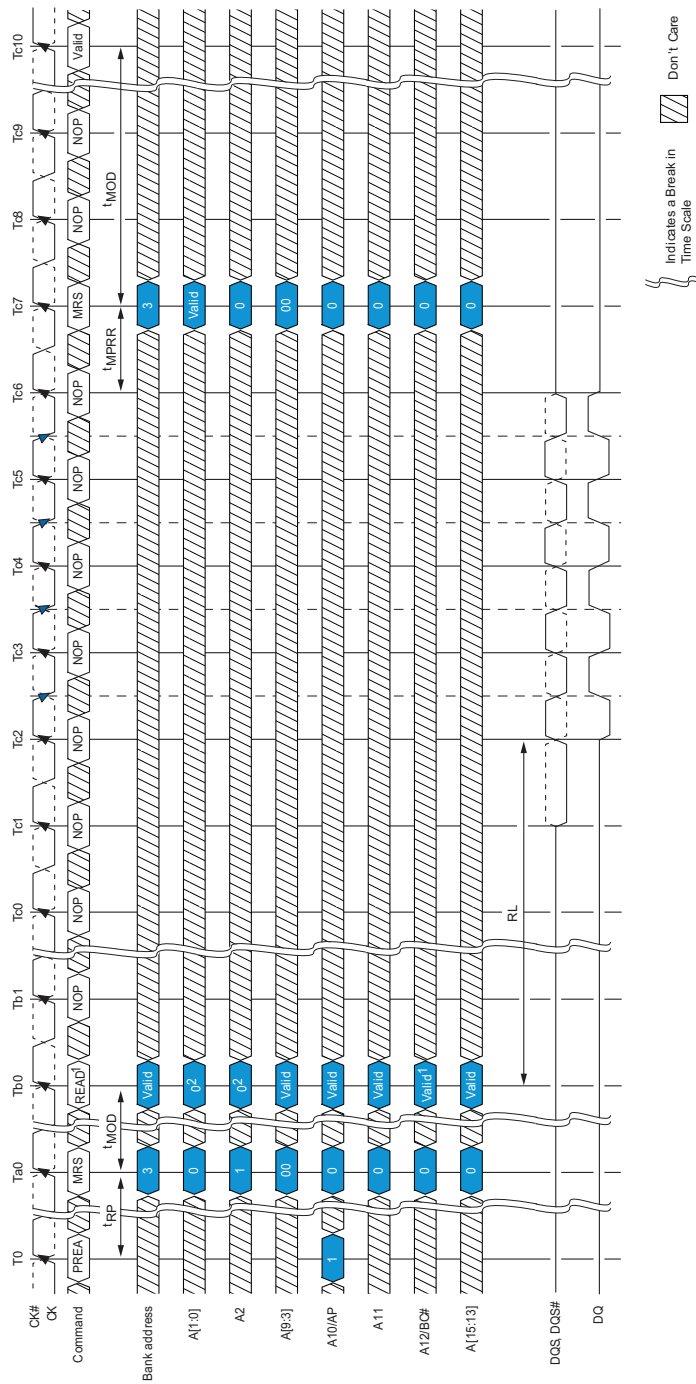
The MPR currently supports a single data format. This data format is a predefined READ pattern for system calibration. The predefined pattern is always a repeating 0-1 bit pattern.

Examples of the different type of predefined READ pattern bursts are shown in Figures 52, 53, and 54.

**TABLE 62: BURST ORDER**

MR3[2]	MR3[1:0]	Function	Burst Length	Read A[2:0]	Burst Order and Data Pattern
1	00	READ predefined pattern for system calibration	BL8	000	Burst Order: 0,1,2,3,4,5,6,7 Predefined pattern: 0,1,0,1,0,1,0,1
			BC4	000	Burst Order: 0,1,2,3 Predefined pattern: 0,1,0,1
			BC4	100	Burst Order: 4,5,6,7 Predefined pattern: 0,1,0,1
1	01	RFU	n/a	n/a	n/a
			n/a	n/a	n/a
			n/a	n/a	n/a
1	10	RFU	n/a	n/a	n/a
			n/a	n/a	n/a
			n/a	n/a	n/a
1	11	RFU	n/a	n/a	n/a
			n/a	n/a	n/a
			n/a	n/a	n/a

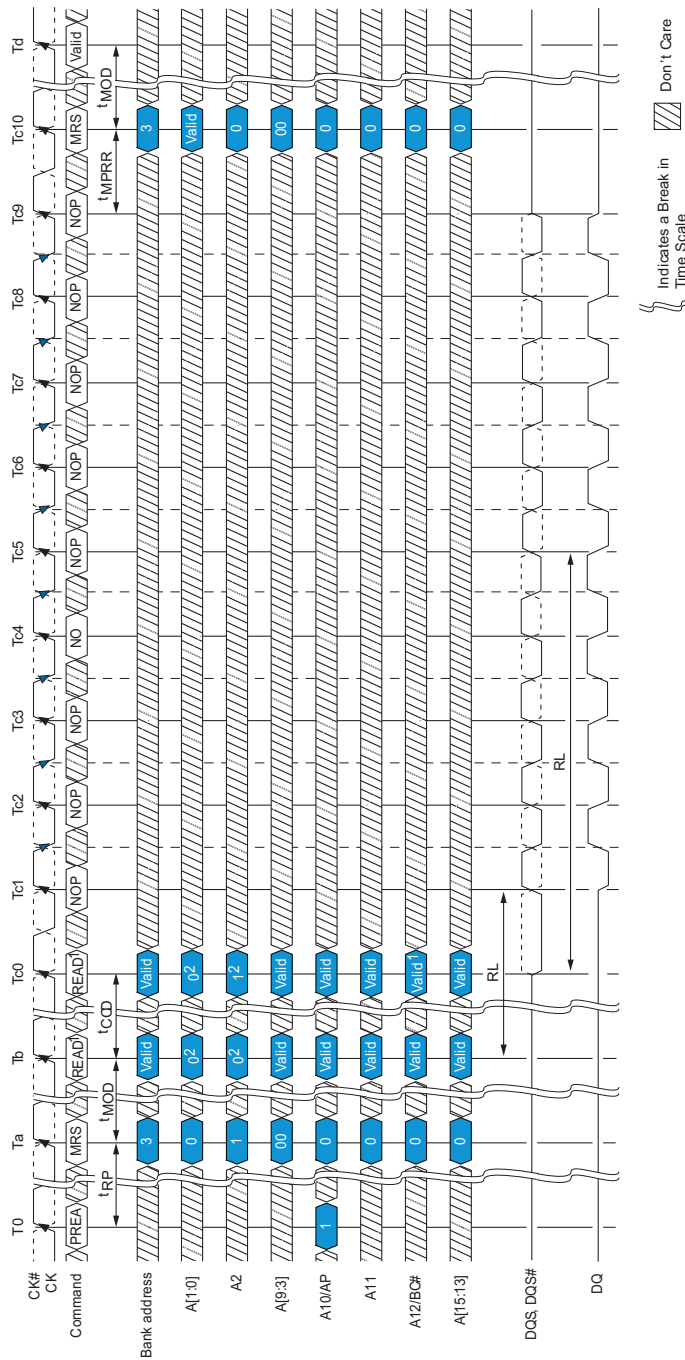
**Figure 52 - MPR System Read Calibration with BL8: Fixed Burst Order Single Readout**



- Notes:
- 1. READ with BL8 either by MRS or OTF.
  - 2. Memory controller must drive 0 on A[2:0].

16-32 Gb, DDR3, 256-512M x 32 Dual Channel Memory Module

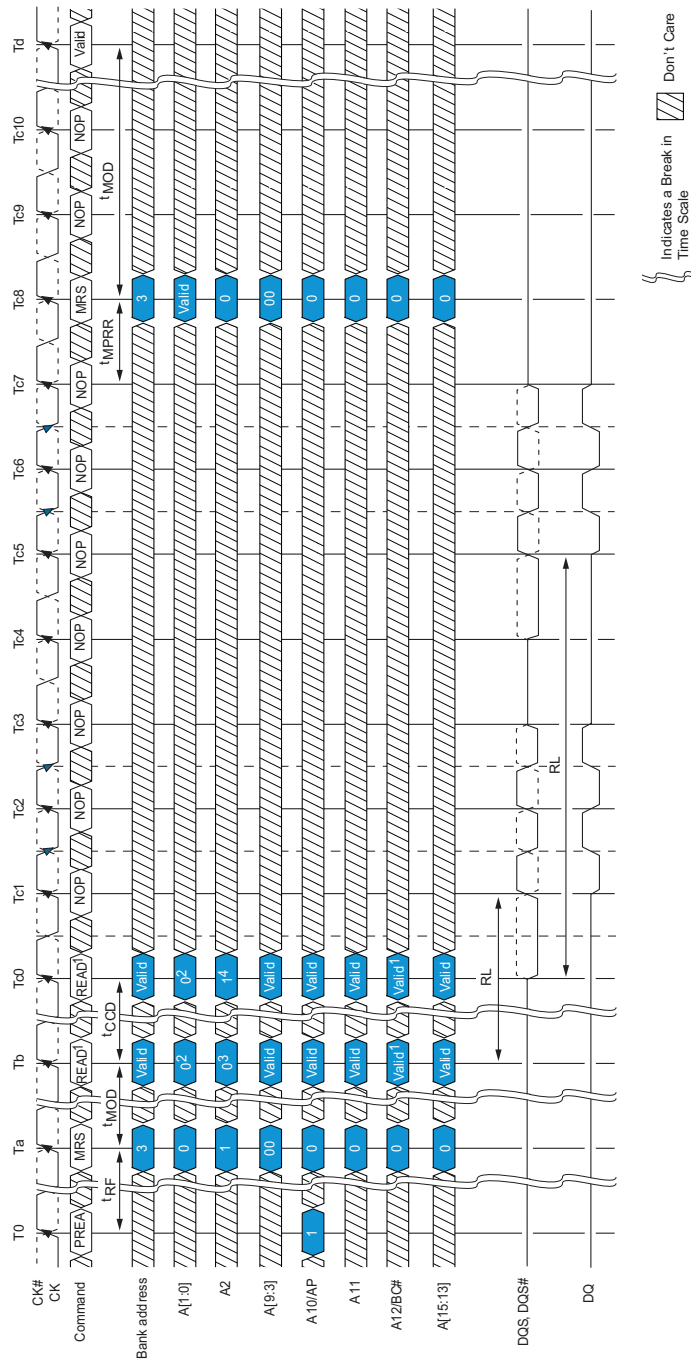
**Figure 53 - MPR System Read Calibration with BL8: Fixed Burst Order, Back-to-Back Readout**



- Notes:
1. READ with BL8 either by MRS or OTF.
  2. Memory controller must drive 0 on A[2:0].

16-32 Gb, DDR3, 256-512M x 32 Dual Channel Memory Module

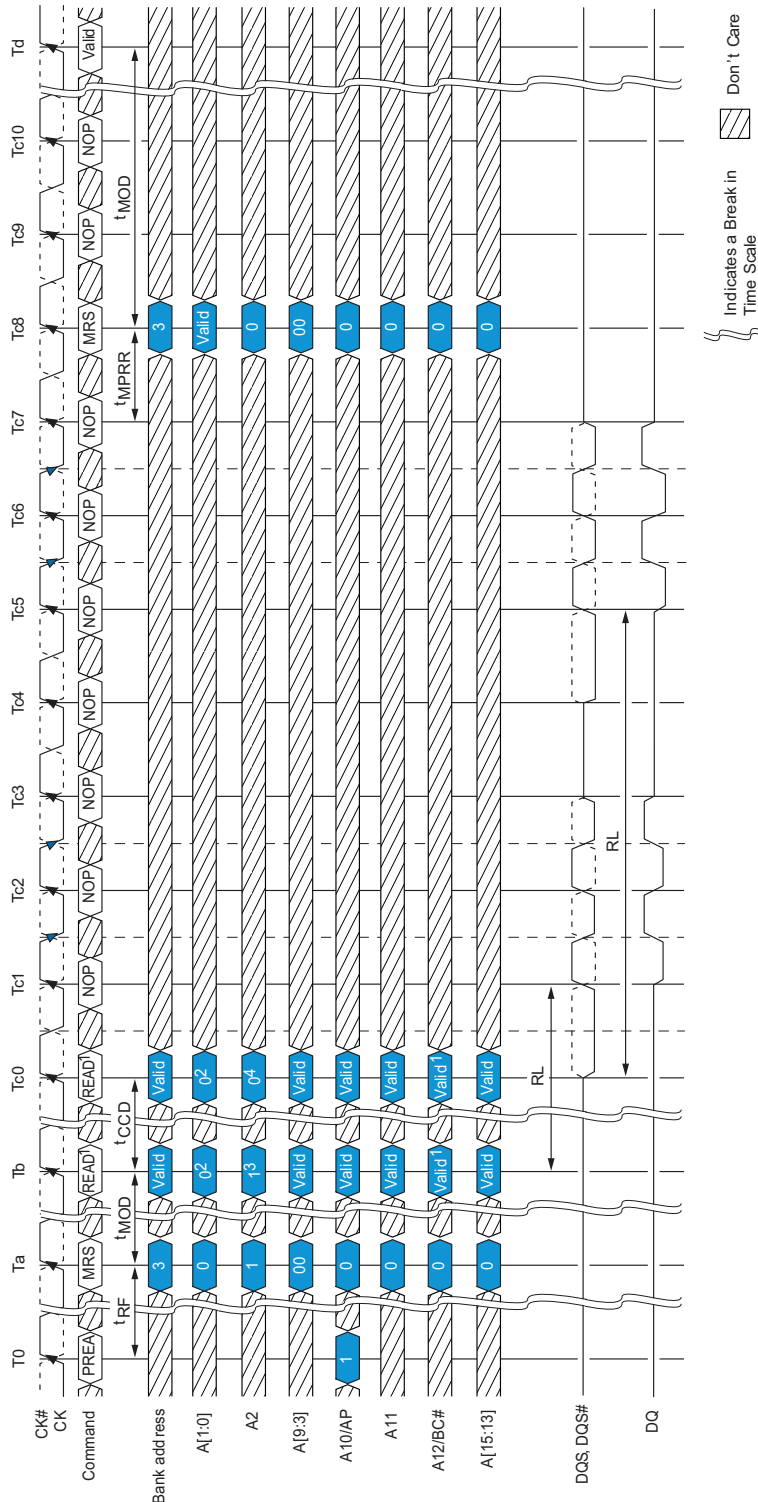
**Figure 54 - MPR System Read Calibration with BC4: Lower Nibble, Then Upper Nibble**



- Notes:
1. READ with BC4 either by MRS or OTF.
  2. Memory controller must drive 0 on A[1:0].
  3. A2 = 0 selects lower 4 nibble bits 0 . . . 3.
  4. A2 = 1 selects upper 4 nibble bits 4 . . . 7.

16-32 Gb, DDR3, 256-512M x 32 Dual Channel Memory Module

Figure 55 - MPR System Read Calibration with BC4: Upper Nibble, Then Lower Nibble



- Notes:
1. READ with BC4 either by MRS or OTF.
  2. Memory controller must drive 0 on A[1:0].
  3. A2 = 1 selects upper 4 nibble bits 4 . . . 7.
  4. A2 = 0 selects lower 4 nibble bits 0 . . . 3.



## 16-32 Gb, DDR3, 256-512M x 32 Dual Channel Memory Module

### MPR READ PREDEFINED PATTERN

The predetermined READ calibration pattern is a fixed pattern of 0,1,0,1,0,1,0,1. The following is an example of using the READ out predetermined READ calibration pattern. The example is to perform multiple READS from the MULTIPURPOSE REGISTER (MPR) in order to do system level READ timing calibration based on the predetermined and standardized pattern.

The following protocol outlines the steps used to perform the READ calibration:

- Precharge all banks
- After  $t_{RP}$  is satisfied, set MRS, MR3[2] = 1 and MR3[1:0]=00. This redirects all subsequent READs and Loads the predefined pattern into the MPR. As soon as  $t_{MRD}$  and  $t_{MOD}$  are satisfied, the MPR is available.
- Data WRITE operations are not allowed until the MPR returns to the normal SDRAM state
- Issue a READ with burst order information (all other address pins are "Don't Care"):
  - A[1:0] = 00 (data burst order is fixed starting at nibble)
  - A2 = 0 (for BL8, burst order is fixed as 0,1,2,3,4,5,6,7)
  - A12 = 1 (use BL8)
- After RL = AL + CL, the SDRAM bursts out the predefined READ calibration pattern (0,1,0,1,0,1,0,1)
- The memory controller repeats the calibration READs until READ data capture at the memory controller is optimized
- After the last MPR READ burst and after  $t_{MPRR}$  has been satisfied, issue MRS, MR3[2] = 0 and MR3[1:0] = "Don't Care" to the normal SDRAM state. All subsequent READ and WRITE accesses will be regular READS and WRITES from/to the SDRAM array
- When  $t_{MRD}$  and  $t_{MOD}$  are satisfied from the last MRS, the regular SDRAM commands (such as ACTIVATE a Memory bank for regular READ or WRITE access) are permitted

### MODE REGISTER SET (MRS)

The mode registers are loaded via inputs BA[2:0], A[13:0]. BA[2:0] determines which mode register is programmed:

- BA2 = 0, BA1 = 0, BA0 = 0 for MR0
- BA2 = 0, BA1 = 0, BA0 = 1 for MR1
- BA2 = 0, BA1 = 1, BA0 = 0 for MR2
- BA2 = 0, BA1 = 1, BA0 = 1 for MR3

The MRS command can only be issued (or reissued) when all banks are idle and in the precharged state ( $t_{RP}$  is satisfied and no data bursts are in progress). The controller must wait the specified time  $t_{MRD}$  before initiating a subsequent operation such as an ACTIVATE command. There is also a restriction after issuing an MRS command with regard to when the updated functions become available. This parameter is specified by  $t_{MOD}$ . Both  $t_{MRD}$  and  $t_{MOD}$  parameters are shown in Figure 42 and 43. Violating either of these requirements will result in unspecified operation.

### ZQ CALIBRATION

The ZQ CALIBRATION command is used to calibrate the SDRAM output drivers (RON) and ODT values (RTT) over process, voltage, and temperature, provided a dedicated 240Ω (±1%) external resistor is connected from the SDRAM's ZQ ball to VssQ.

DDR3 SDRAMs need a longer time to calibrate RON and ODT at power up INITIALIZATION and SELF REFRESH exit and a relatively shorter time to perform periodic calibrations. DDR3 SDRAM defines two ZQ CALIBRATION commands: ZQ CALIBRATION LONG (ZQCL) and ZQ CALIBRATION SHORT (ZQCS). An example of ZQ CALIBRATION timing is shown in Figure 56.

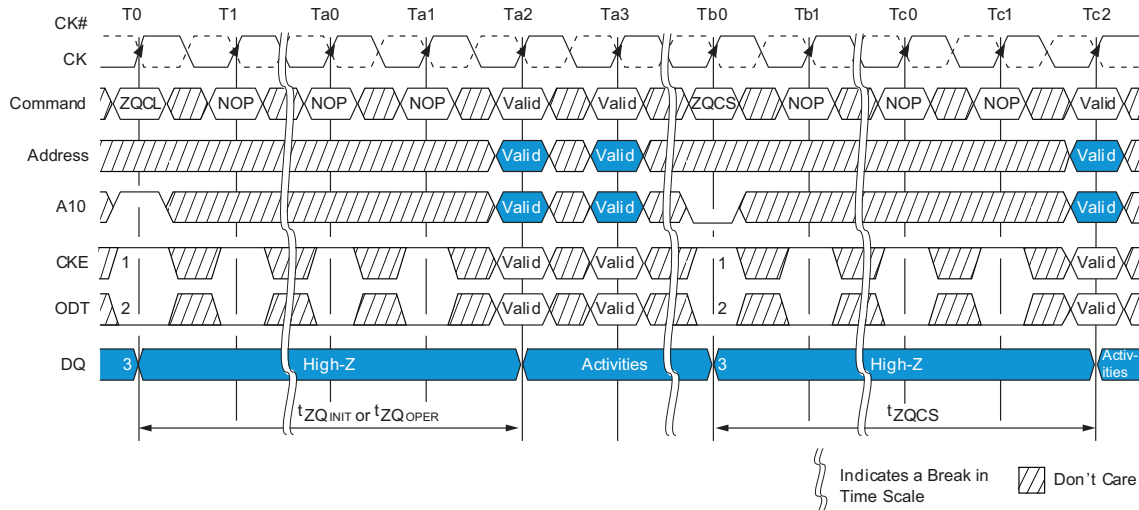
All banks must be PRECHARGED and  $t_{RP}$  must be met before ZQCL or ZQCS commands can be issued to the SDRAM. No other activities (other than another ZQCL or ZQCS command may be issued to the SDRAM) can be performed on the SDRAM array by the controller for the duration of  $t_{ZQINIT}$  or  $t_{ZQOPER}$ . The quiet time on the SDRAM array helps accurately calibrate RON and ODT. After SDRAM calibration is achieved, the SDRAM should disable the ZQ ball's current consumption path to reduce overall power usage.

ZQ CALIBRATION commands can be issued in parallel to DLL RESET and locking time. Upon SELF REFRESH exit, an explicit ZQCL is required if ZQ CALIBRATION is desired.

In dual rank system designs that share the ZQ resistor between devices, the controller must not allow overlap of  $t_{ZQINT}$ ,  $t_{ZQOPER}$  or  $t_{ZQCS}$  between ranks.

**16-32 Gb, DDR3, 256-512M x 32 Dual Channel Memory Module**

**FIGURE 56 - ZQ CALIBRATION TIMING (ZQCL AND ZQCS)**



**NOTES:**

1. CKE must be continuously registered HIGH during the calibration procedure.
2. ODT must be disabled via the ODT signal or the MRS during the calibration procedure.
3. All devices connected to the DQ bus should be High-Z during calibration.

**ACTIVATE**

Before any READ or WRITE commands can be issued to a bank within the SDRAM, a ROW in that bank must be opened (ACTIVATED). This is accomplished via the ACTIVATE command, which selects both the BANK and the ROW to be ACTIVATED.

After a ROW is opened with an ACTIVATE command, a READ or WRITE command may be issued to that ROW, subject to the  $t_{RCD}$  specification. However, if the additive latency is programmed correctly, a READ or WRITE command may be issued prior to  $t_{RCD}$  (MIN). In this operation, the SDRAM enables a READ or WRITE command to be issued after the ACTIVATE command for that bank, but prior to  $t_{RCD}$  (MIN) (see "POSTED CAS ADDITIVE LATENCY (AL)").  $t_{RCD}$  (MIN) should be divided by the clock period and rounded up to the next whole number to determine the earliest clock edge after the ACTIVATE command on which the READ or WRITE command can be entered. The same procedure is used to convert other specification limits from time units to clock cycles.

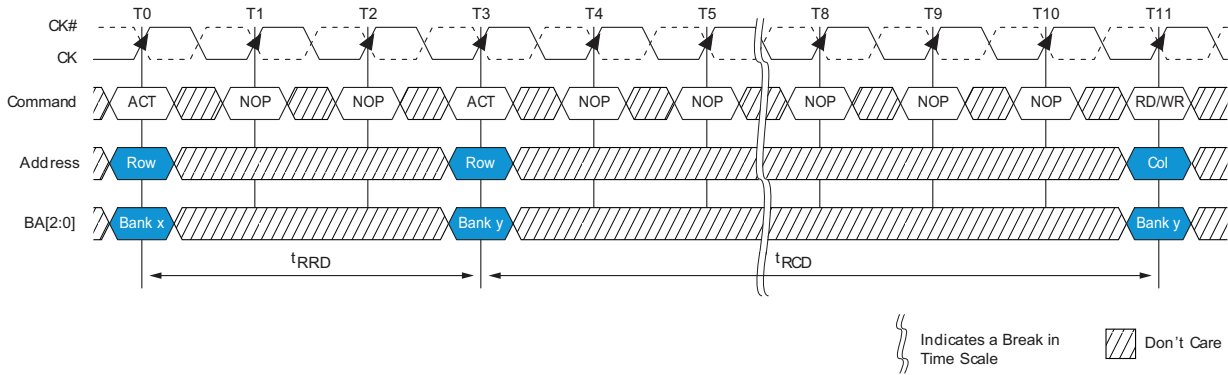
When at least one bank is open, any READ-to-READ command delay or WRITE-to-WRITE command delay is restricted to  $t_{CCD}$  (MIN).

A subsequent ACTIVATE command to a different ROW in the same BANK can only be issued after the previous ACTIVE ROW has been closed (PRE-CHARGED). The minimum time interval between successive ACTIVATE commands to the same BANK is defined by  $t_{RC}$ .

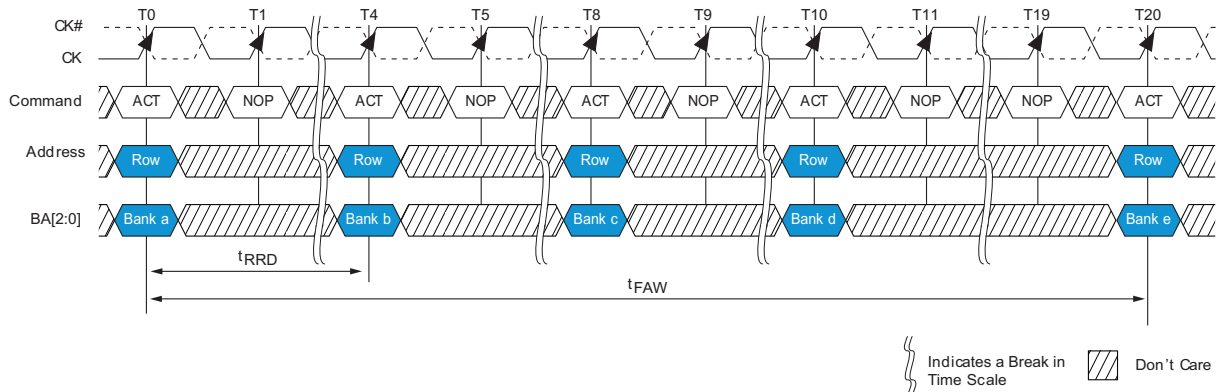
A subsequent ACTIVATE command to another BANK can be issued while the first BANK is being accessed, which results in a reduction of total ROW-ACCESS overhead. The minimum time interval between successive ACTIVATE commands may be issued in a given  $t_{FAW}$  (MIN) period, and the  $t_{RRD}$  (MIN) restriction still applies. The  $t_{FAW}$  (MIN) parameter applies, regardless of the number of BANKS already opened or closed.

**16-32 Gb, DDR3, 256-512M x 32 Dual Channel Memory Module**

**FIGURE 57 - EXAMPLE: MEETING  $t_{RRD}$  (MIN) AND  $t_{RCD}$  (MIN)**



**FIGURE 58 - EXAMPLE:  $t_{FAW}$**



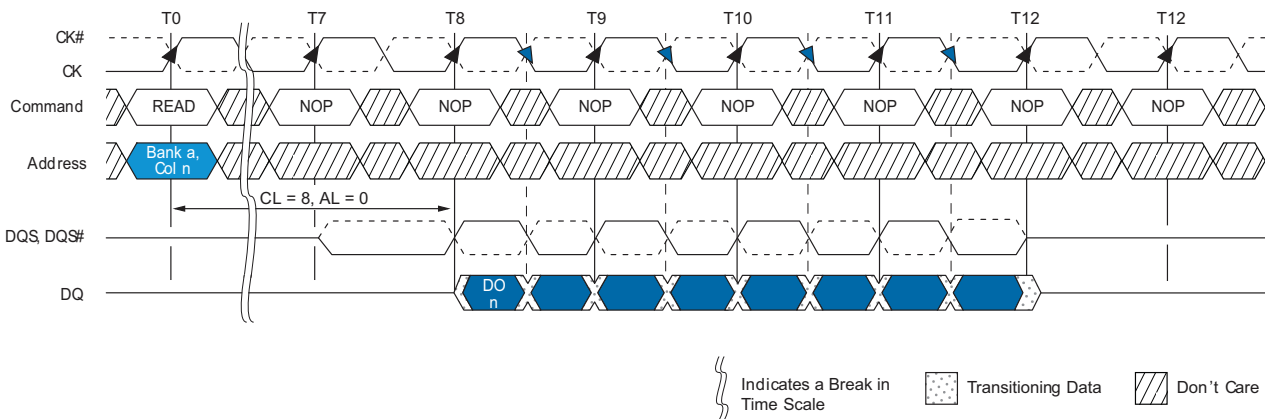
**16-32 Gb, DDR3, 256-512M x 32 Dual Channel Memory Module**

**READ**

READ bursts are initiated with a READ command. The starting COLUMN and BANK addresses are provided with the READ command and AUTO PRECHARGE is either enabled or disabled for that burst access. If AUTO PRECHARGE is enabled, the ROW being accessed is automatically PRECHARGED at the completion of the burst sequence. If AUTO PRECHARGE is disabled, the ROW will be left open after the completion of the burst.

During READ bursts, the valid data out element from the starting column address is available at READ LATENCY (RL) clocks later. RL is defined as the sum of POSTED CAS ADDITIVE LATENCY (AL) and CAS LATENCY (CL) ( $RL = AL + CL$ ). The value of AL and CL is programmable in the mode register via the MRS command. Each subsequent data-out element will be valid nominally at the next positive or negative clock edge (that is, at the next crossing of CK and CK $\bar$ ). Figure 59 shows an example of RL based on a CL setting of 8 as well as AL=0.

**FIGURE 59 - READ LATENCY**



- Notes: 1. DO n = data-out from column n.  
2. Subsequent elements of data-out appear in the programmed order following DO n.

L[U]DQSx, L[U]DQSx $\bar$  is driven by the SDRAM along with the output data. The initial LOW state on L[U]DQSx and HIGH state on L[U]DQSx $\bar$ , is known as the READ preamble ( ${}^1RPRE$ ). The LOW state on DQSx and the HIGH state on L[U]DQSx $\bar$ , coincident with the last data-out element, is known as the READ postamble ( ${}^1RPST$ ). Upon completion of a burst, assuming no other commands have been initiated, the DQ will go HIGH-Z. A detailed explanation of  ${}^1DQSQ$  (valid data-out skew),  ${}^1QH$  (data-out window hold), and the valid data window are depicted in Figure 71. A detailed explanation of  ${}^1DQSCK$  (DQS transition skew to CK) is also depicted in Figure 71.

Data from any READ burst may be concatenated with data from a subsequent READ command to provide a continuous flow of data. The first data element from the new burst follows the last element of a completed burst. The new READ command should be issued  ${}^1CCD$  cycles after the first READ command. This is shown for BL8 in Figure 60. If BC4 is enabled,  ${}^1CCD$  must still be met which will cause a gap in the data output, as shown in Figure 61. Nonconsecutive READ data is reflected in Figure 62. DDR3 SDRAMs do not allow interrupting or truncating any READ burst.

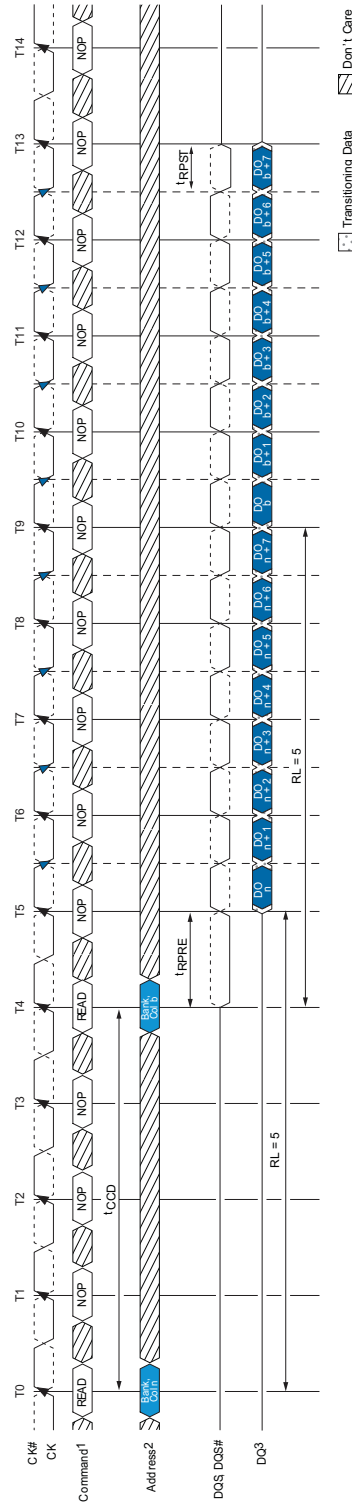
Data from any READ burst must be completed before a subsequent WRITE burst is allowed. An example of a READ burst followed by a WRITE burst for BL8 is shown in Figure 63. To ensure the READ data is completed before the WRITE data is on the bus, the minimum READ-to-WRITE timing is  $RL + {}^1CCD - WL + 2{}^1CK$ .

A READ burst may be followed by a PRECHARGE command to the same bank provided AUTO PRECHARGE is not ACTIVATED. The minimum READ-to-PRECHARGE command spacing to the same bank is four clocks and must also satisfy a minimum analog time from the READ command. This time is called  ${}^1RTP$  (READ-to-PRECHARGE).  ${}^1RTP$  starts AL cycles later than the READ command. Examples for BL8 are shown in Figure 65 and BC4 in Figure 66. Following the PRECHARGE command, a subsequent command to the same bank cannot be issued until  ${}^1RP$  is met. The PRECHARGE command followed by another PRECHARGE command to the same bank is allowed. However, the precharge period will be determined by the last PRECHARGE command issued to the bank.

If A10 is HIGH when a READ command is issued, the READ with AUTO PRECHARGE function is engaged. The SDRAM starts an AUTO PRECHARGE operation on the rising edge which is  $AL + {}^1RTP$  cycles after the READ command. DDR3 SDRAMs support a  ${}^1RAS$  lockout feature (see Figure 68). If  ${}^1RAS$  (MIN) is not satisfied at the edge, the starting point of the AUTO PRECHARGE operation will be delayed until  ${}^1RAS$  (MIN) is satisfied. In case the internal PRECHARGE operation is pushed out by  ${}^1RTP$ ,  ${}^1RP$  starts at the point at which the internal PRECHARGE happens. The time from READ with AUTO PRECHARGE to the next ACTIVATE command the same bank is  $AL + ({}^1RTP + {}^1RP)^*$ , where  ${}^1*$  means rounded up to the next integer. In any event, internal RECHARGE does not start earlier than four clocks after the last 8n-bit prefetch.

**16-32 Gb, DDR3, 256-512M x 32 Dual Channel Memory Module**

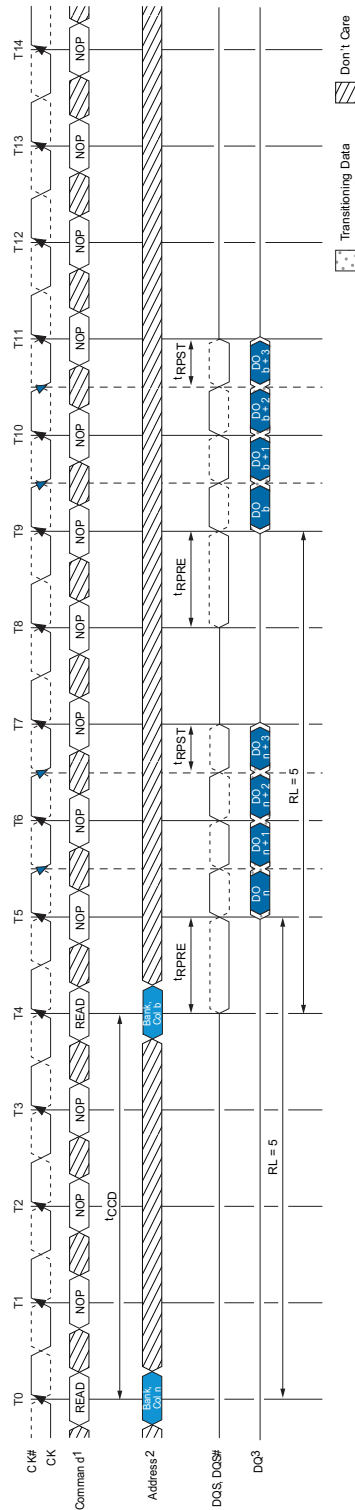
**Figure 60 - Consecutive READ Bursts (BL8)**



- Notes:
1. NOP commands are shown for ease of illustration; other commands may be valid at these times.
  2. The BL8 setting is activated by either MR0[1:0] = 00 or MR0[1:0] = 01 and A12 = 1 during READ command at T0 and T4.
  3. DO n (or b) = data-out from column n (or column b).
  4. BL8, RL = 5 (CL = 5, AL = 0).

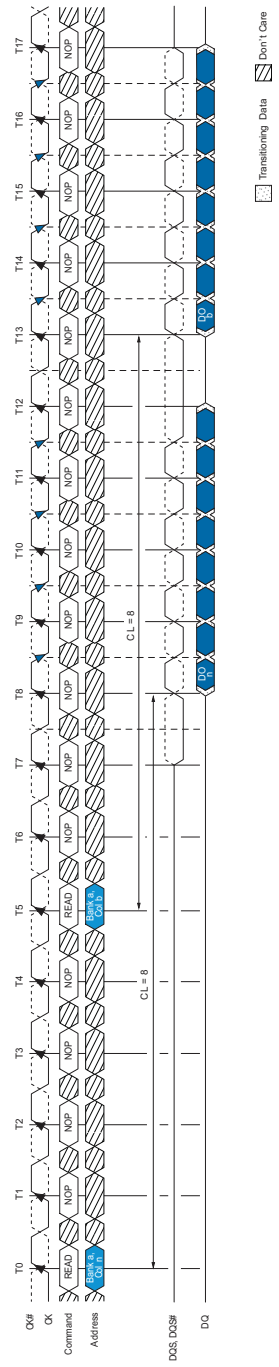
**16-32 Gb, DDR3, 256-512M x 32 Dual Channel Memory Module**

**Figure 61 - Consecutive READ Bursts (BC4)**



- Notes:
1. NOP commands are shown for ease of illustration; other commands may be valid at these times.
  2. The BC4 setting is activated by either MR0[1:0] = 10 or MR0[1:0] = 01 and A12 = 0 during READ command at T0 and T4.
  3. DO n (or b) = data-out from column n (or column b).
  4. BC4, RL = 5 (CL = 5, AL = 0).

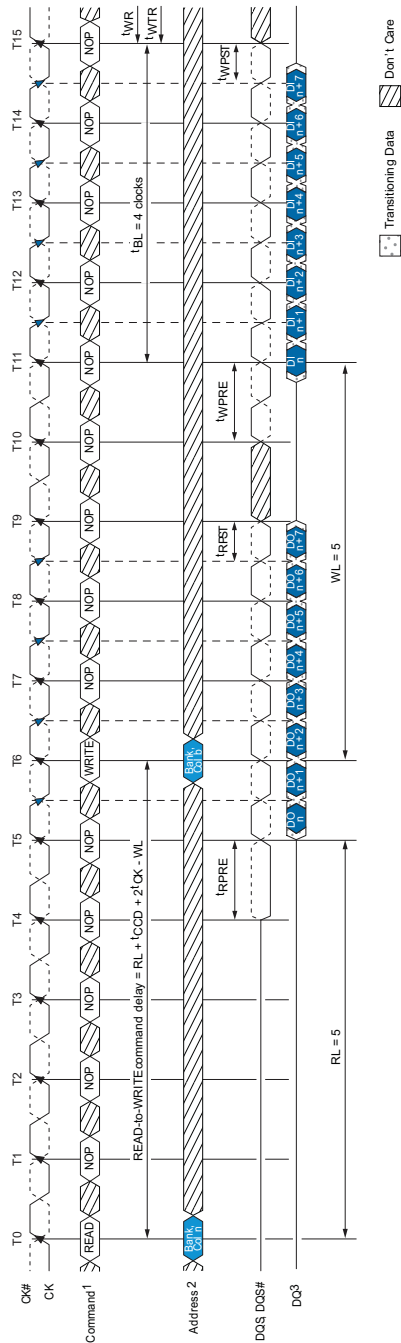
**Figure 62 - Nonconsecutive READ Bursts**



- Notes:
1. AL = 0, RL = 8.
  2. DO n (or b) = data-out from column n (or column b).
  3. Seven subsequent elements of data-out appear in the programmed order following DO n.
  4. Seven subsequent elements of data-out appear in the programmed order following DO b.

**16-32 Gb, DDR3, 256-512M x 32 Dual Channel Memory Module**

**Figure 63 - READ (BL8) to WRITE (BL8)**

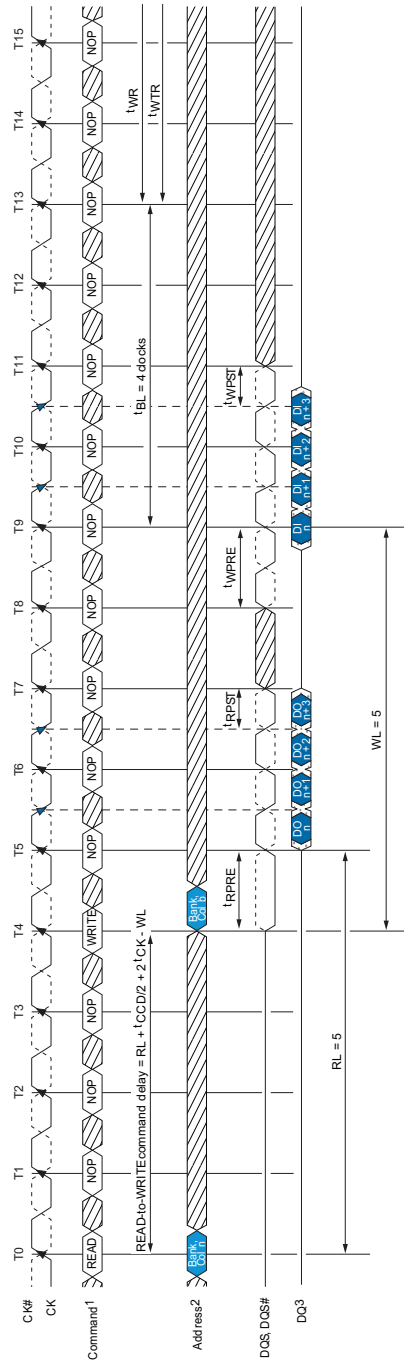


- Notes:
1. NOP commands are shown for ease of illustration; other commands may be valid at these times.
  2. The BL8 setting is activated by either MR0[1:0] = 00 or MR0[1:0] = 01 and A12 = 1 during the READ command at T0, and the WRITE command at T6.



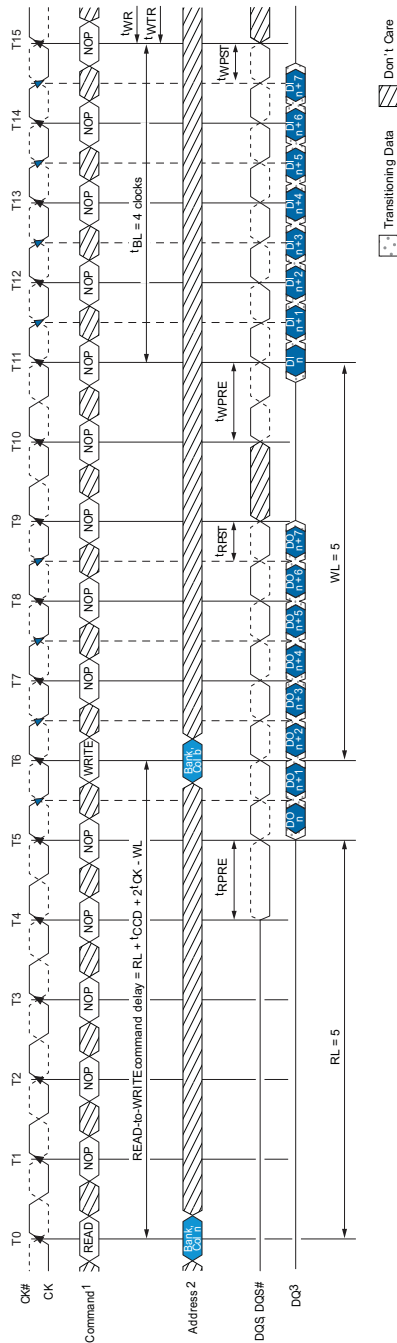
16-32 Gb, DDR3, 256-512M x 32 Dual Channel Memory Module

**Figure 64 - READ (BC4) to WRITE (BC4) OTF**



- Notes:
1. NOP commands are shown for ease of illustration; other commands may be valid at these times.
  2. The BC4 OTF setting is activated by MR0[1:0] and A12 = 0 during READ command at T0 and WRITE command at T4.
  3. DO n = data-out from column n; DI n = data-in from column b.
  4. BC4, RL = 5 (AL = 0, CL = 5), WL = 5 (AL = 0, CWL = 5).

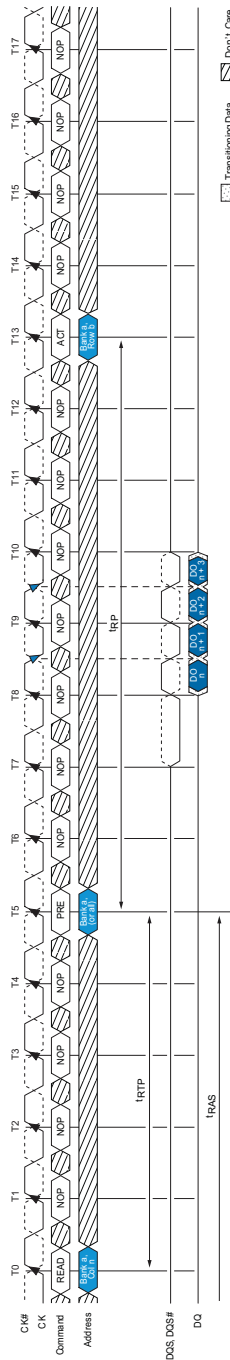
**Figure 65 - READ to PRECHARGE (BL8)**



- Notes:
1. NOP commands are shown for ease of illustration; other commands may be valid at these times.
  2. The BL8 setting is activated by either MR0[1:0] = 00 or MR0[1:0] = 01 and A12 = 1 during the READ command at T0, and the WRITE command at T6.
  3. DO n = data-out from column, Dlb = data-in for column b.
  4. BL8, RL = 5 (AL = 0, CL = 5), WL = 5 (AL = 0, CWL = 5).

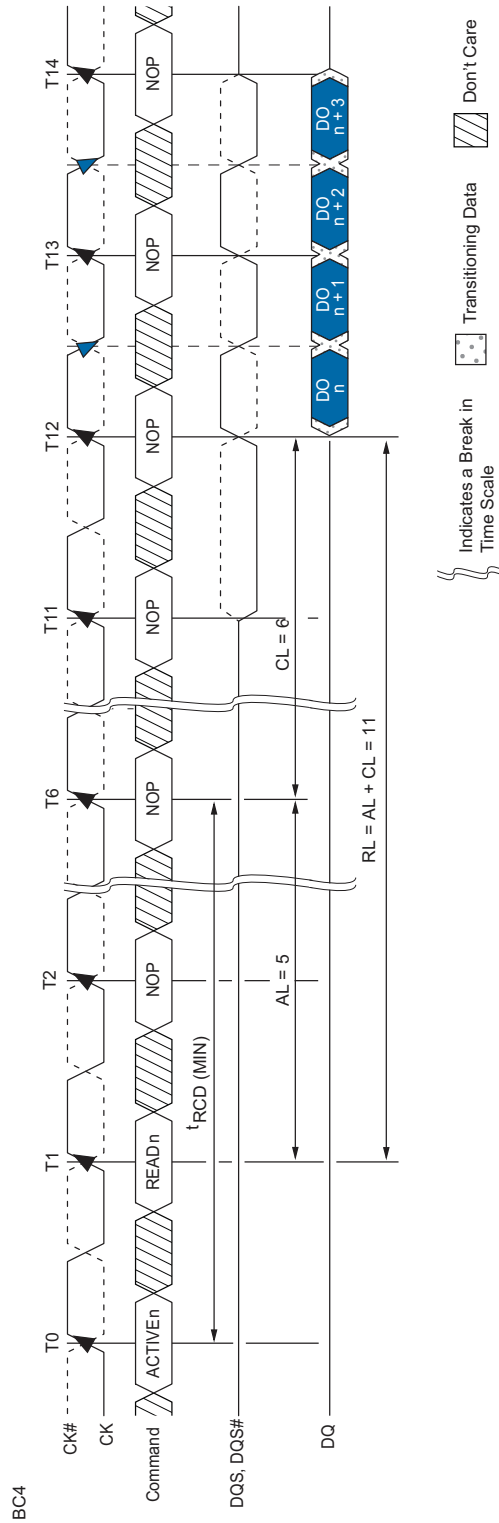
16-32 Gb, DDR3, 256-512M x 32 Dual Channel Memory Module

**Figure 66 - READ to PRECHARGE (BC4)**



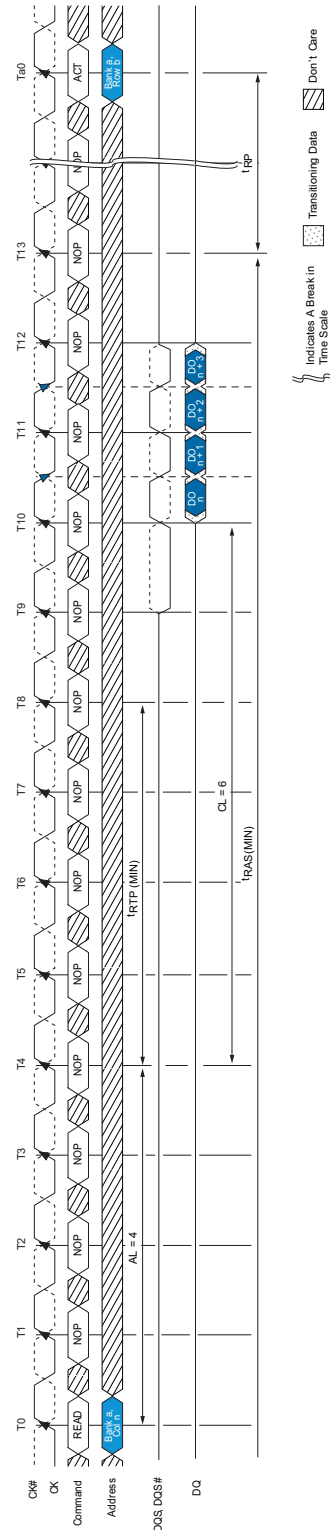
**16-32 Gb, DDR3, 256-512M x 32 Dual Channel Memory Module**

**Figure 67 - READ to PRECHARGE (AL = 5, CL = 6)**



16-32 Gb, DDR3, 256-512M x 32 Dual Channel Memory Module

**Figure 68 - READ with Auto Precharge (AL = 4, CL = 6)**



## 16-32 Gb, DDR3, 256-512M x 32 Dual Channel Memory Module

### READ

A DQSx to DQ output timing is shown in Figure 69. The DQ transitions between valid data outputs must be within  $t_{DQSQ}$  of the crossing point of L[U]DQSx, L[U]DQSx\ . DQS must also maintain a minimum HIGH and LOW time of  $t_{QSH}$  and  $t_{QSL}$ . Prior to the READ preamble, the DQ balls will either be floating or terminated depending on the status of the ODT signal.

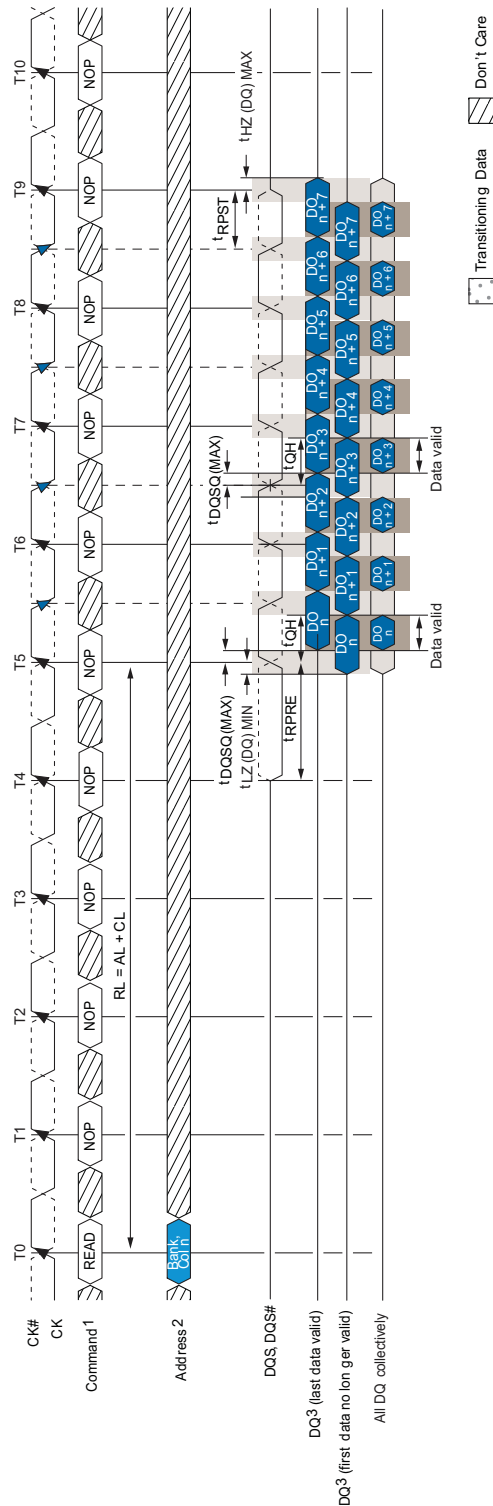
Figure 70 shows the strobe-to-clock timing during a READ. The crossing point DQSx, DQSx\ must transition with  $\pm t_{DQSCK}$  of the clock crossing point. The data out has no timing relationship to clock, only to DQS, as shown in Figure 70.

Figure 70 also shows the READ preamble and postamble. Normally, both DQSx and DQSx\ are HIGH-Z to save power ( $V_{DDQ}$ ). Prior to data output from the SDRAM, DQSx is driven LOW and DQSx\ driven HIGH for  $t_{RPRE}$ . This is known as the READ preamble.

The READ postamble,  $t_{RPST}$ , is one half clock from the last L[U]DQSx, L[U]DQSx\ transition. During the READ postamble, L[U]DQSx is driven LOW and L[U]DQSx\ driven HIGH. When complete, the DQ will either be disabled or will continue terminating depending on the state of the ODT signal. Figure 75 demonstrates how to measure  $t_{RPST}$ .

16-32 Gb, DDR3, 256-512M x 32 Dual Channel Memory Module

**Figure 69 - Data Output Timing – tDQSQ and Data Valid Window**



- Notes:
1. NOP commands are shown for ease of illustration; other commands may be valid at these times.
  2. The BL8 setting is activated by either MR0[1, 0] = 0, 0 or MR0[0, 1] = 0, 1 and A12 = 1 during READ command at T0.
  3. DO n = data-out from column n.
  4. BL8, RL = 5 (AL = 0, CL = 5).
  5. Output timings are referenced to V<sub>CCQ/2</sub> and DLL on and locked.
  6. tDQSQ defines the skew between DQS, DQS# to data and does not define DQS, DQS# to clock.
  7. Early data transitions may not always happen at the same DQ. Data transitions of a DQ can vary (either early or late) within a burst.

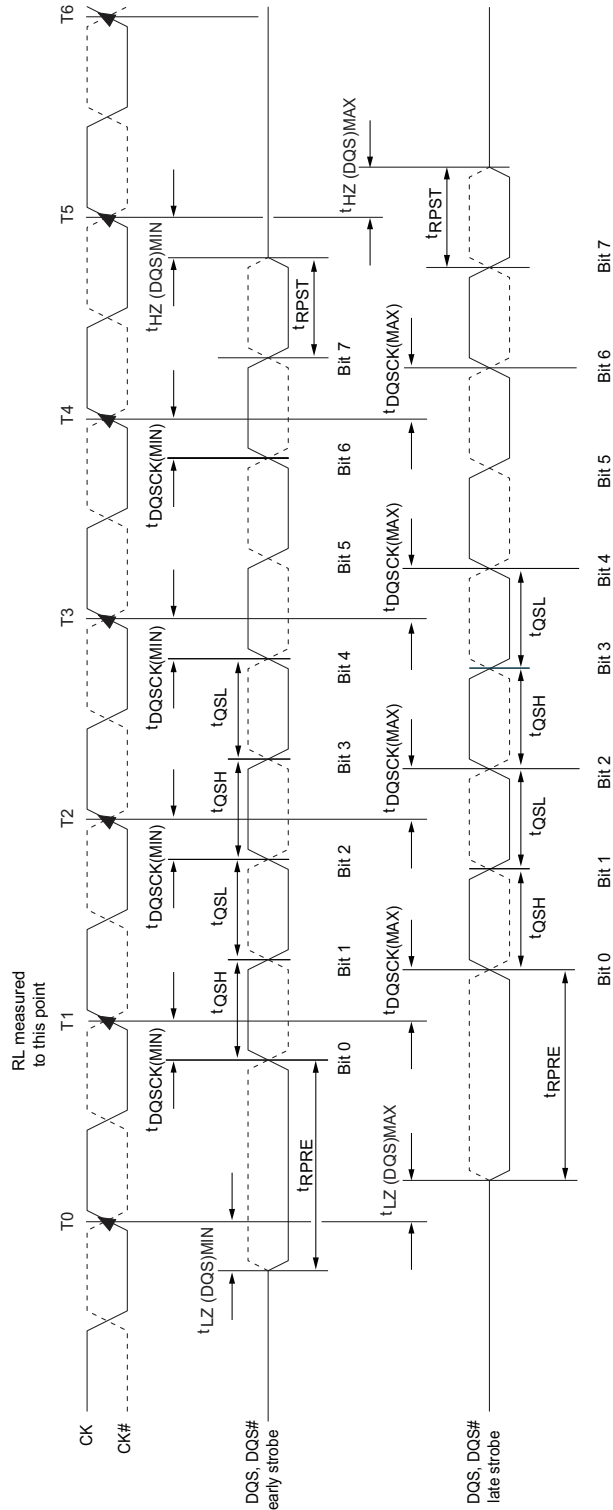
**16-32 Gb, DDR3, 256-512M x 32 Dual Channel Memory Module**

**OUTPUT TIMING**

<sup>t</sup>HZ and <sup>t</sup>LZ transitions occur in the same access time as valid data transitions. These parameters are referenced to a specific voltage level which specifies when the device output is no longer driving <sup>t</sup>HZ (DQS) and <sup>t</sup>HZ (DQ) or begins driving <sup>t</sup>LZ (DQS). <sup>t</sup>LZ (DQ), Figure 71 shows a method to calculate the point when the device is no longer driving <sup>t</sup>HZ (DQS) and <sup>t</sup>HZ (DQ) or begins driving <sup>t</sup>LZ (DQS), <sup>t</sup>LZ (DQ) by measuring the signal at two different voltages. The actual voltage measurement points are not critical as long as the calculation is consistent. The parameters <sup>t</sup>LZ (DQS), <sup>t</sup>LZ (DQ), <sup>t</sup>HZ (DQS) and <sup>t</sup>HZ (DQ) are defined as single-ended.

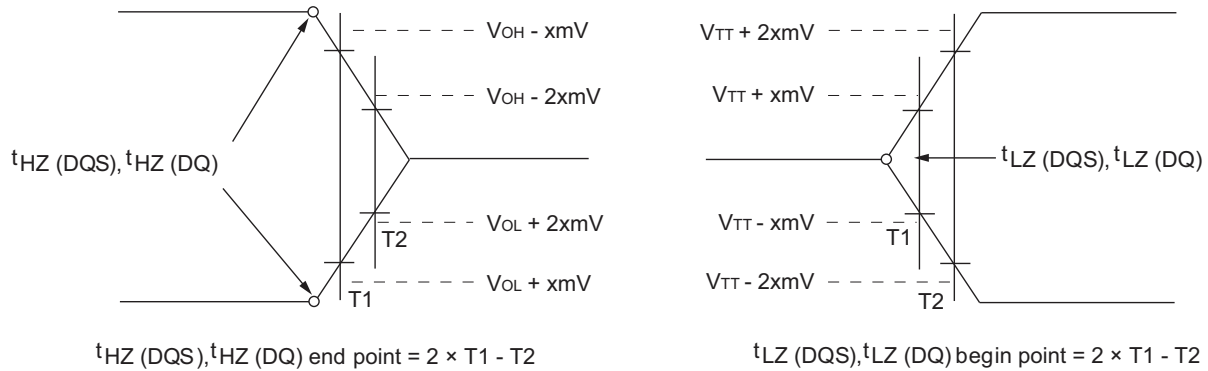


**Figure 70 - Data Strobe Timing – READs**



16-32 Gb, DDR3, 256-512M x 32 Dual Channel Memory Module

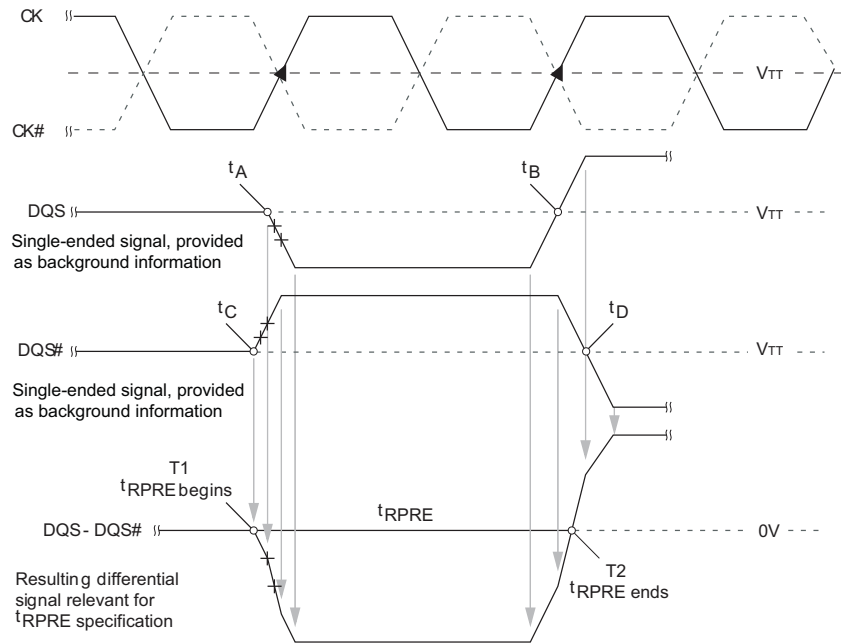
**Figure 71 - Method for Calculating  $t_{LZ}$  and  $t_{HZ}$**



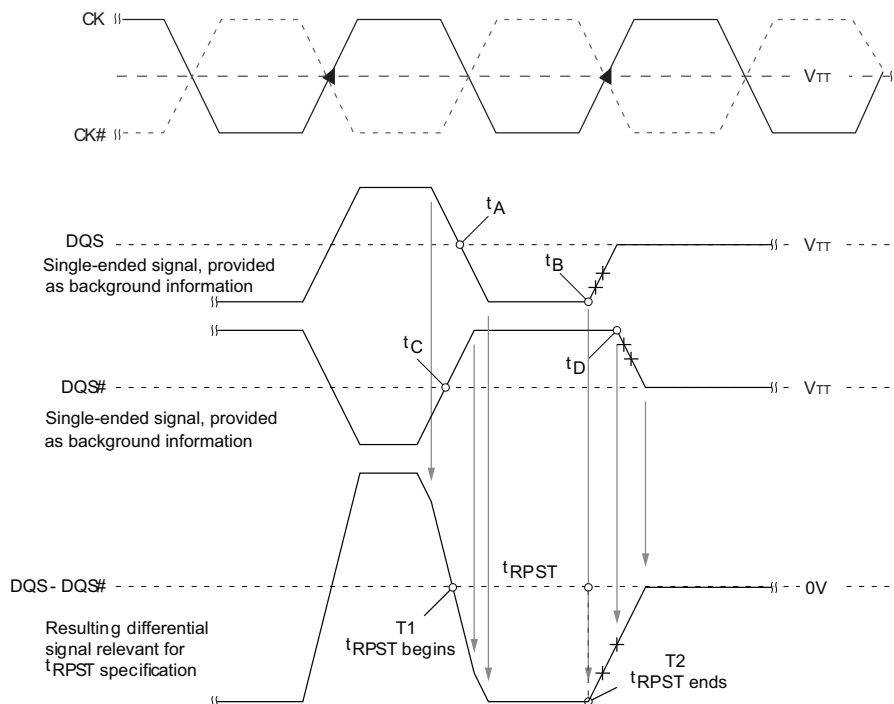
- Notes:
1. Within a burst, the rising strobe edge is not necessarily fixed at  $t_{DQSCK} (MIN)$  or  $t_{DQSCK} (MAX)$ . Instead, the rising strobe edge can vary between  $t_{DQSCK} (MIN)$  and  $t_{DQSCK} (MAX)$ .
  2. The DQS high pulse width is defined by  $t_{QSH}$ , and the DQS low pulse width is defined by  $t_{QSL}$ . Likewise,  $t_{LZ} (DQS) MIN$  and  $t_{HZ} (DQS) MIN$  are not tied to  $t_{DQSCK} (MIN)$  (early strobe case) and  $t_{LZ} (DQS) MAX$  and  $t_{HZ} (DQS) MAX$  are not tied to  $t_{DQSCK} (MAX)$  (late strobe case); however, they tend to track one another.
  3. The minimum pulse width of the READ preamble is defined by  $t_{RPRE} (MIN)$ . The minimum pulse width of the READ postamble is defined by  $t_{RPST} (MIN)$ .

**16-32 Gb, DDR3, 256-512M x 32 Dual Channel Memory Module**

**FIGURE 72 -  $t_{RPRE}$  TIMING**

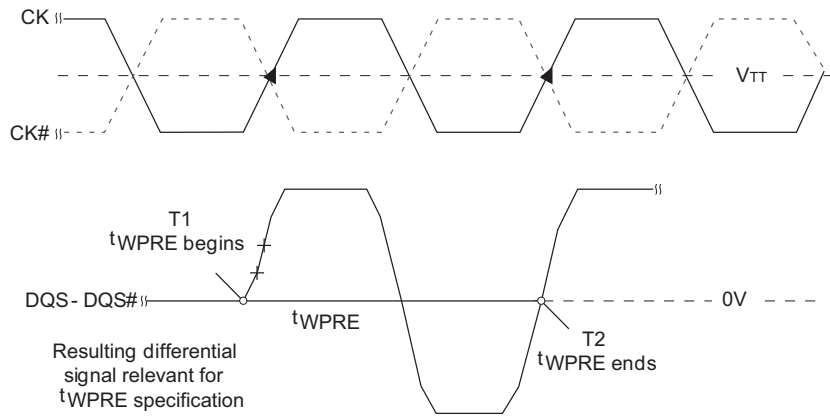


**FIGURE 73 -  $t_{RPST}$  TIMING**

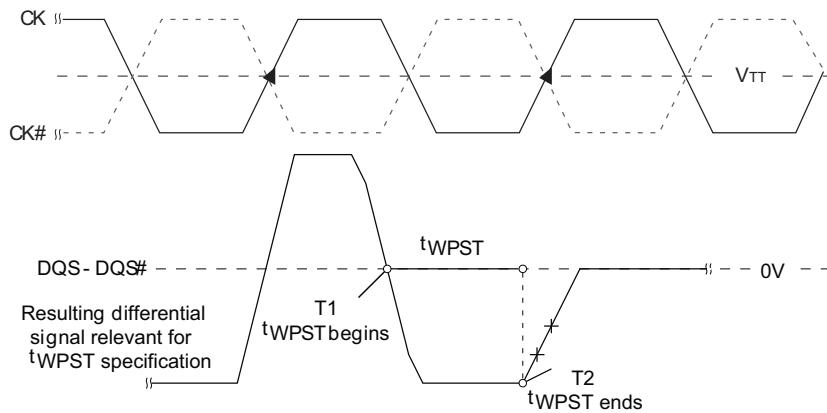


**16-32 Gb, DDR3, 256-512M x 32 Dual Channel Memory Module**

**FIGURE 74 -  $t_{WPRE}$  TIMING**



**FIGURE 75 -  $t_{WPST}$  TIMING**



## 16-32 Gb, DDR3, 256-512M x 32 Dual Channel Memory Module

### WRITE

WRITE bursts are initiated with a WRITE command. The starting COLUMN and BANK addresses are provided with the WRITE command, and AUTO PRECHARGE is selected, the ROW being accessed will be PRECHARGED at the end of WRITE burst. If AUTO PRECHARGE is not selected, the ROW will remain open for subsequent accesses. After a WRITE command has been issued, the WRITE burst may not be interrupted. For the generic WRITE commands used in Figure 76 through Figure 84, AUTO PRECHARGE is disabled.

During WRITE bursts, the first valid data-in element is registered on a rising edge of DQSx following the WRITE LATENCY (WL) clocks later and subsequent data elements will be registered on successive edges of DQSx. WRITE LATENCY (WL) is defined as the sum of POSTED CAS ADDITIVE LATENCY (AL) and CAS WRITE LATENCY (CWL):  $WL = AL + CWL$ . The values of AL and CWL are programmed in the MR- and MR2 registers, respectively. Prior to the first valid DQSx edge, a full cycle is needed (including a dummy crossover of DQSx, DQSx') and specified as the WRITE preamble shown in Figure 76. The half cycle on DQSx following the last data-in element is known as the WRITE postamble.

The time between the WRITE command and the first valid edge of DQSx is  $WL$  clocks  $\pm$   $t_{DQSS}$ . Figure 77 through Figure 84 show the nominal case where  $t_{DQSS} = 0ns$ ; however, Figure 76 includes  $t_{DQSS} (MIN)$  and  $t_{DQSS} (MAX)$  cases.

Data may be masked from completing a WRITE using data mask. The mask occurs on the DM ball aligned to the WRITE data. If DM is LOW, the WRITE completes normally. If DM is HIGH, that bit of data is masked.

Upon completion of a burst, assuming no other commands have been initiated, the DQ will remain HIGH-Z and any additional input data will be ignored.

Data for any WRITE burst may be concatenated with a subsequent WRITE command to provide a continuous flow of input data. The new WRITE command can be  $t_{CCD}$  clocks following the previous WRITE command. The first data element from the new burst is applied after the last element of a completed burst. Figures 77 and 78 show concatenated bursts. An example of nonconsecutive WRITES is shown in Figure 79.

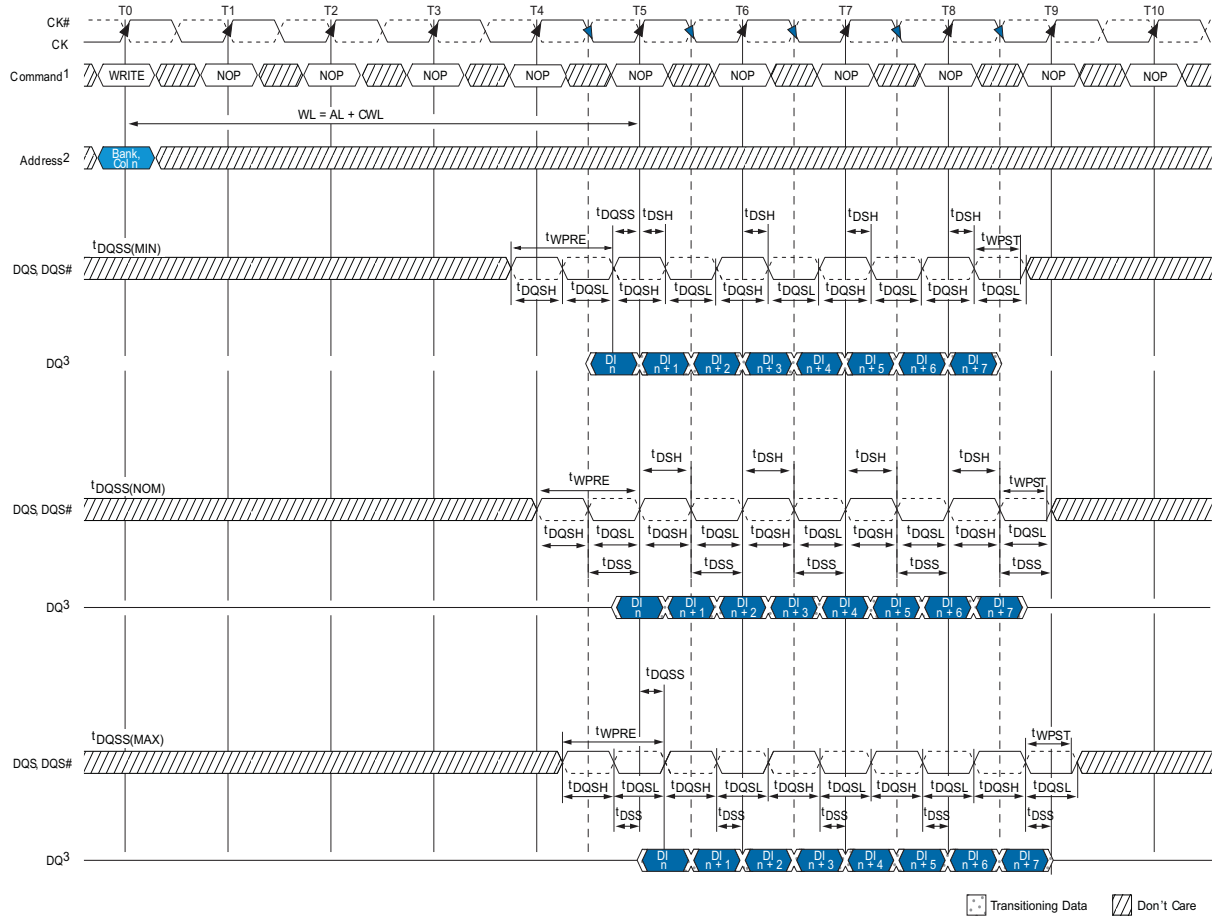
Data for any WRITE burst may be followed by a subsequent READ command after  $t_{WTR}$  has been met (see Figures 80, 81 and 82).

Data for any WRITE burst may be followed by a subsequent PRECHARGE command providing  $t_{WR}$  has been met, as shown in Figure 83 and Figure 84.

Both  $t_{WTR}$  and  $t_{WR}$  starting time may vary depending on the mode register settings (fixed BC4, BL8 vs. OTF).

**16-32 Gb, DDR3, 256-512M x 32 Dual Channel Memory Module**

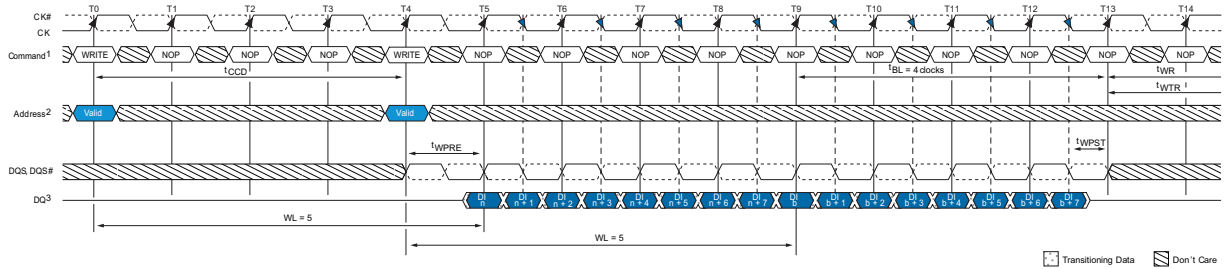
**FIGURE 76 - WRITE BURST**



- Notes:
1. NOP commands are shown for ease of illustration; other commands may be valid at these times.
  2. The BL8 setting is activated by either MR0[1:0] = 00 or MR0[1:0] = 01 and A12 = 1 during the WRITE command at T0.
  3. DI n = data-in for column n.
  4. BL8, WL = 5 (AL = 0, CWL = 5).
  5.  $t_{DQSS}$  must be met at each rising clock edge.
  6.  $t_{WPST}$  is usually depicted as ending at the crossing of DQS, DQS#; however,  $t_{WPST}$  actually ends when DQS no longer drives LOW and DQS# no longer drives HIGH.

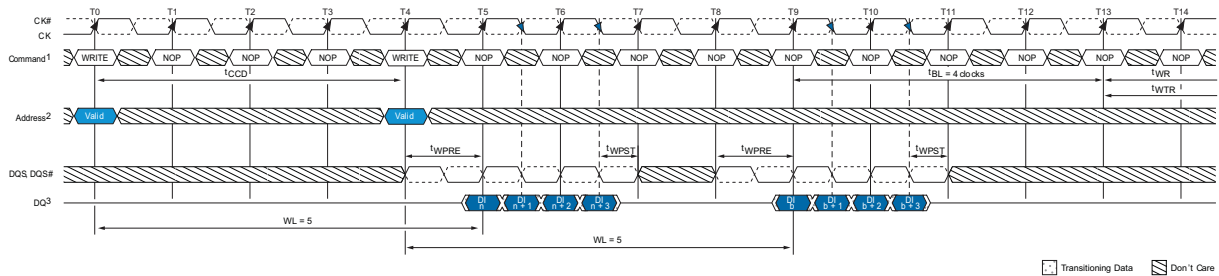
**16-32 Gb, DDR3, 256-512M x 32 Dual Channel Memory Module**

**FIGURE 77 - CONSECUTIVE WRITE (BL8) TO WRITE (BL8)**



- Notes:
1. NOP commands are shown for ease of illustration; other commands may be valid at these times.
  2. The BL8 setting is activated by either MR0[1:0] = 00 or MR0[1:0] = 01 and A12 = 1 during the WRITE commands at T0 and T4.
  3. DI n (or b) = data-in for column n (or column b).
  4. BL8, WL = 5 (AL = 0, CWL = 5).

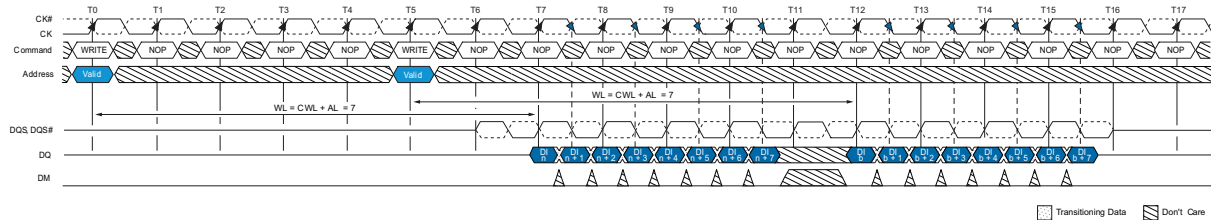
**FIGURE 78 - CONSECUTIVE WRITE (BC4) TO WRITE (BC4) VIA MRS OR OTF**



- Notes:
1. NOP commands are shown for ease of illustration; other commands may be valid at these times.
  2. BC4, WL = 5 (AL = 0, CWL = 5).
  3. DI n (or b) = data-in for column n (or column b).
  4. The BC4 setting is activated by MR0[1:0] = 01 and A12 = 0 during the WRITE command at T0 and T4.

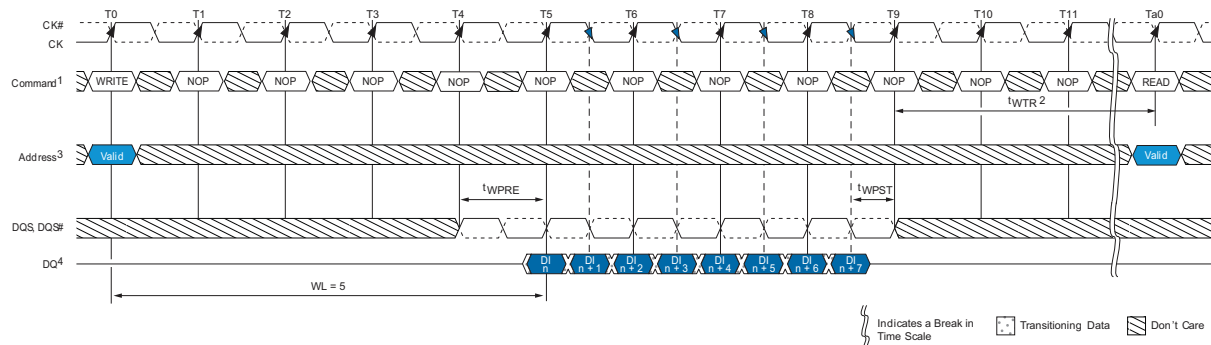
**16-32 Gb, DDR3, 256-512M x 32 Dual Channel Memory Module**

**FIGURE 79 - NONCONSECUTIVE WRITE TO WRITE**



- Notes:
1. DI n (or b) = data-in for column n (or column b).
  2. Seven subsequent elements of data-in are applied in the programmed order following DQn.
  3. Each WRITE command may be to any bank.
  4. Shown for WL = 7 (CWL = 7, AL = 0).

**FIGURE 80 - WRITE (BL8) TO READ (BL8)**

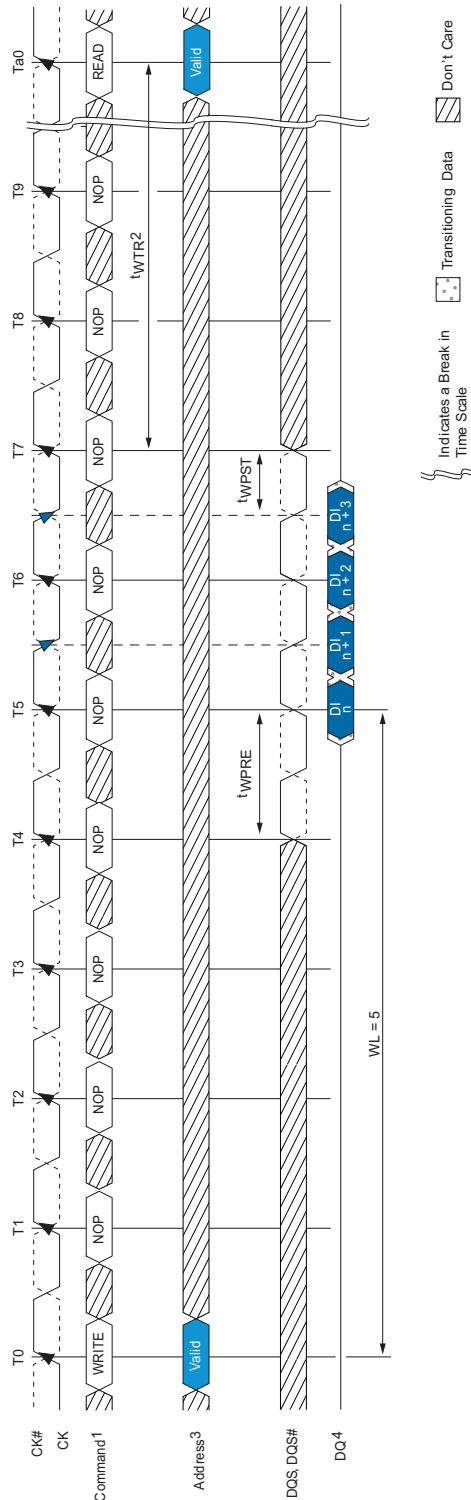


- Notes:
1. NOP commands are shown for ease of illustration; other commands may be valid at these times.
  2.  $t_{WTR}^2$  controls the WRITE-to-READ delay to the same device and starts with the first rising clock edge after the last write data shown at T9.
  3. The BL8 setting is activated by either MR0[1:0] = 00 or MR0[1:0] = 01 and MR0[12] = 1 during the WRITE command at T0. The READ command at Ta0 can be either BC4 or BL8, depending on MR0[1:0] and the A12 status at Ta0.
  4. DI n = data-in for column n.
  5. RL = 5 (AL = 0, CL = 5), WL = 5 (AL = 0, CWL = 5).



16-32 Gb, DDR3, 256-512M x 32 Dual Channel Memory Module

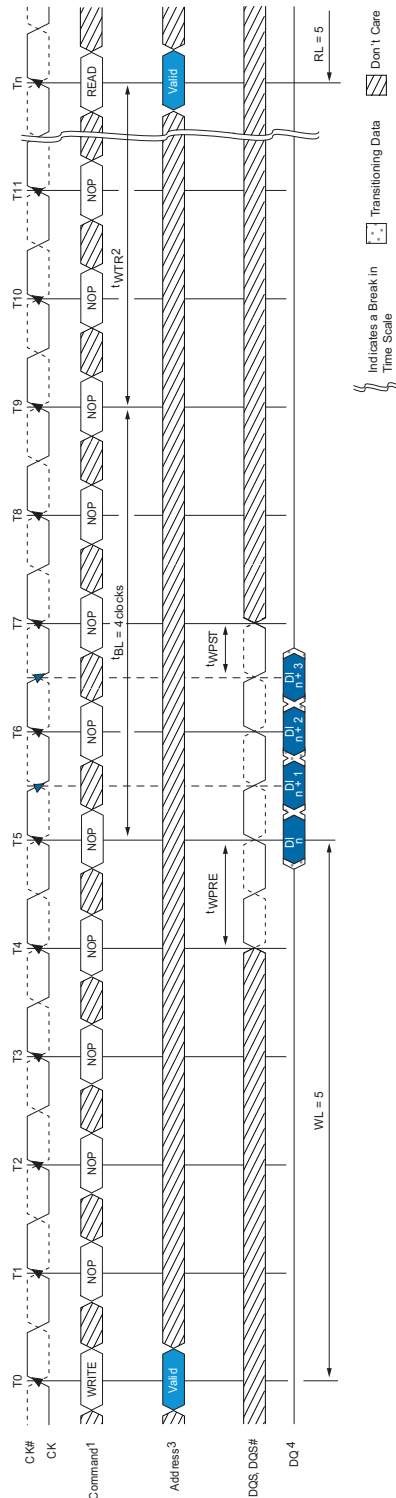
**FIGURE 81 - WRITE TO READ (BC4 MODE REGISTER SETTING)**



- Notes:
1. NOP commands are shown for ease of illustration; other commands may be valid at these times.
  2. tWTR controls the WRITE-to-READ delay to the same device and starts with the first rising clock edge after the last write data shown at T7.
  3. The fixed BC4 setting is activated by MR0[1:0] = 10 during the WRITE command at T0 and the READ command at Ta0.
  4. D[ n = data-in for column n.
  5. BC4 (fixed), WL = 5 (AL = 0, CWL = 5), RL = 5 (AL = 0, CL = 5).

16-32 Gb, DDR3, 256-512M x 32 Dual Channel Memory Module

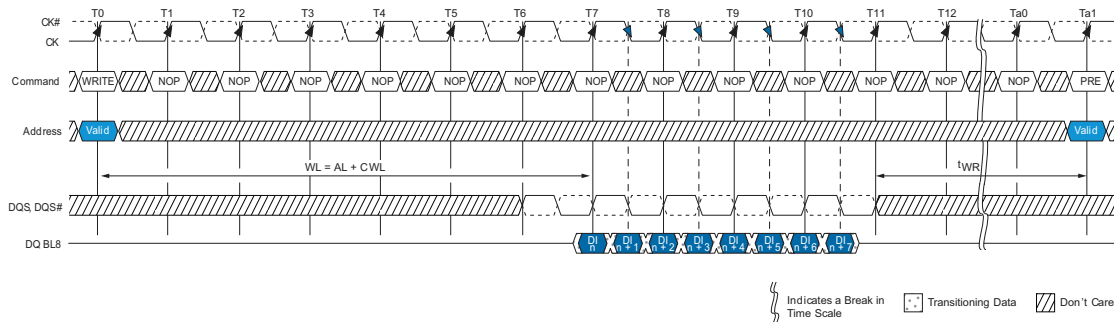
**FIGURE 82 - WRITE (BC4 OTF) TO READ (BC4 OTF)**



- Notes:
1. NOP commands are shown for ease of illustration; other commands may be valid at these times.
  2.  $t_{WTR}$  controls the WRITE-to-READ delay to the same device and starts after 'BL'.
  3. The BC4 OTF setting is activated by MR0[1:0] = 01 and A 12 = 0 during the WRITE command at T0 and the READ command at Tn.
  4. DI n = data-in for column n.
  5. BC4, RL = 5 (AL = 0, CL = 5), WL = 5 (AL = 0, CWL = 5).

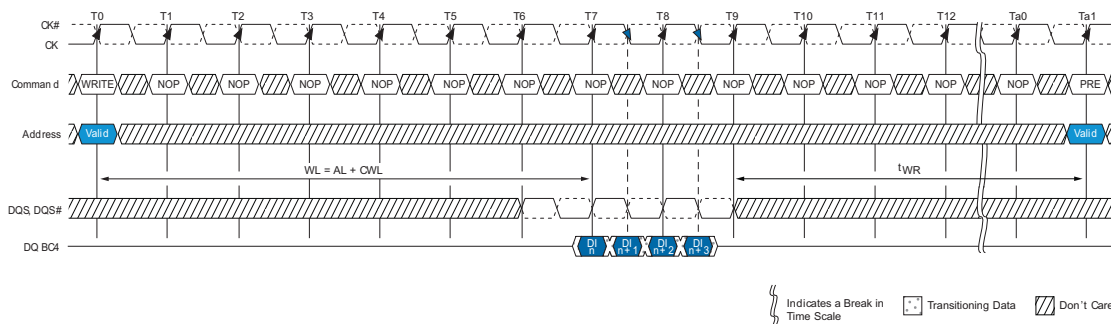
**16-32 Gb, DDR3, 256-512M x 32 Dual Channel Memory Module**

**FIGURE 83 - WRITE (BL8) TO PRECHARGE**



- Notes:
1. DI n = data-in from column n.
  2. Seven subsequent elements of data-in are applied in the programmed order following DO n.
  3. Shown for WL = 7 (AL = 0, CWL = 7).

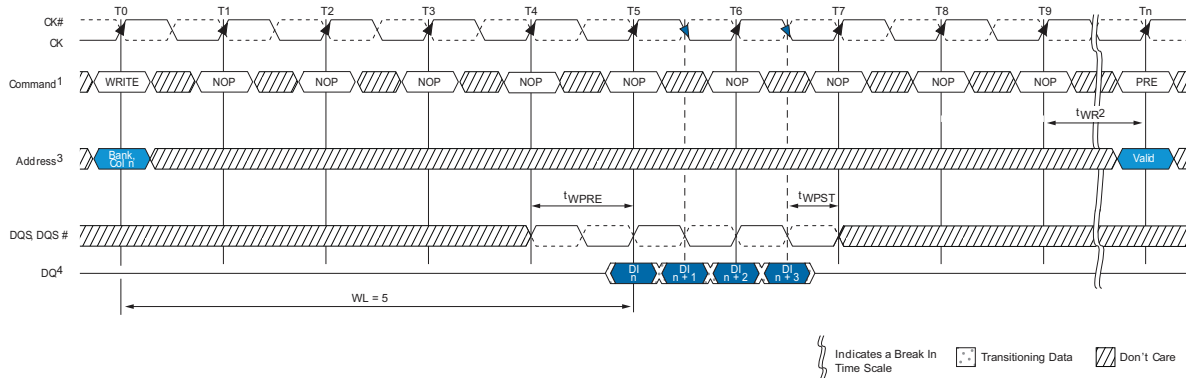
**FIGURE 84 - WRITE (BC4 MODE REGISTER SETTING) TO PRECHARGE**



- Notes:
1. NOP commands are shown for ease of illustration; other commands may be valid at these times.
  2. The write recovery time ( $t_{WR}$ ) is referenced from the first rising clock edge after the last write data is shown at T7.  $t_{WR}$  specifies the last burst WRITE cycle until the PRECHARGE command can be issued to the same bank.
  3. The fixed BC4 setting is activated by MR0[1:0] = 10 during the WRITE command at T0.
  4. DI n = data-in for column n.
  5. BC4 (fixed), WL = 5, RL = 5.

16-32 Gb, DDR3, 256-512M x 32 Dual Channel Memory Module

**FIGURE 85 - WRITE (BC4 OTF) TO PRECHARGE**



- Notes:
1. NOP commands are shown for ease of illustration; other commands may be valid at these times.
  2. The write recovery time ( $t_{WR}$ ) is referenced from the rising clock edge at T9.  $t_{WR}$  specifies the last burst WRITE cycle until the PRECHARGE command can be issued to the same bank.
  3. The BC4 setting is activated by MR0[1:0] = 01 and A12 = 0 during the WRITE command at T0.
  4. DI n = data-in for column n.
  5. BC4 (OTF), WL = 5, RL = 5.

**DQ INPUT TIMING**

Figure 76 shows the strobe to clock timing during a WRITE. DQSx, DQSx\ must transition within  $0.25t_{CK}$  of the clock transitions as limited by  $t_{DQSS}$ . All data and data mask setup and hold timings are measured relative to the DQSx, DQSx\ crossings, not the clock crossing.

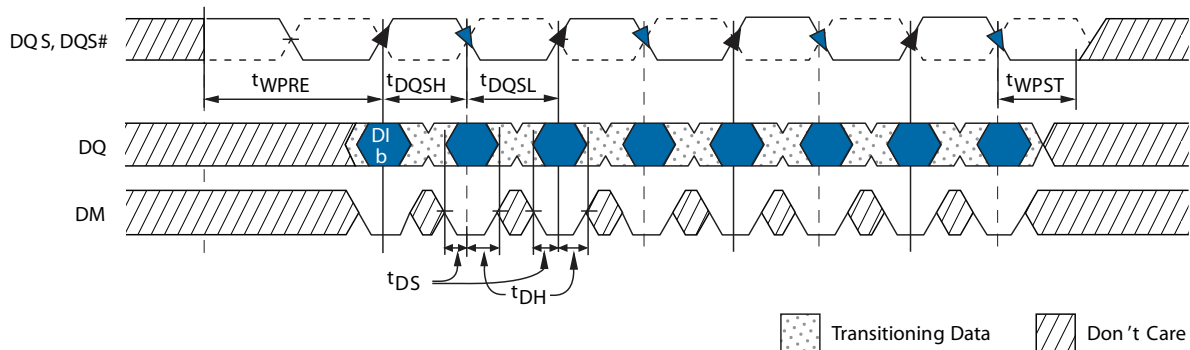
The WRITE preamble and postamble are also shown. One clock prior to data input to the SDRAM, DQSx must be HIGH and DQSx\ must be LOW. Then for a half clock, DQSx is driven LOW (DQSx\ is driven HIGH) during the WRITE preamble.  $t_{WPST}$ , likewise, DQSx must be kept LOW by the

memory controller after the last data is written to the SDRAM during the WRITE postamble,  $t_{WPST}$ .

Data setup and hold times are shown in Figure 86. All setup and hold times are measured from the crossing points of DQSx and DQSx\ . These setup and hold values pertain to data input and data mask input.

Additionally, the half period of the data input strobe is specified by  $t_{DQSH}$  and  $t_{DQSL}$ .

**FIGURE 86 - DATA INPUT TIMING**



## 16-32 Gb, DDR3, 256-512M x 32 Dual Channel Memory Module

### PRECHARGE

Input A10 determines whether one bank or all banks are to be PRECHARGED and in the case where only one bank is to be precharged, inputs BA[2:0] select the array BANK.

When all banks are to be PRECHARGED, inputs BA[2:0] are treated as "Don't Care". After a bank is PRECHARGED, it is in the IDLE State and must be ACTIVATED prior to any READ or WRITE commands being issued.

### SELF REFRESH

The SELF REFRESH command is initiated like a REFRESH command except CKE is LOW. The DLL is automatically disabled upon entering SELF REFRESH and is automatically enabled and reset upon exiting SELF REFRESH. All power supply inputs (including VREFCA and VREFDQ) must be maintained at valid levels upon entry/exit and during SELF REFRESH mode operation. VREFDQ may float or not drive  $V_{DDQ}/2$  while in the SELF REFRESH mode under certain conditions:

- $V_{SS} < V_{REFDQ} < V_{DD}$  is maintained
- VREFDQ is valid and stable prior to CKE going back HIGH
- The first WRITE operation may not occur earlier than 512 clocks after VREFDQ is valid
- All other SELF REFRESH mode exit timing requirements are met

The SDRAM must be idle with all BANKS in the PRECHARGE state ( $t_{RP}$  is satisfied and no bursts are in progress) before a SELF REFRESH entry command can be issued. ODT must also be turned off before SELF REFRESH entry by registering the ODT ball LOW prior to the SELF REFRESH entry command (see "On-Die Termination (ODT) for timing requirements). If  $RTT_{NOM}$  and  $RTT_{WR}$  are disabled in the mode registers, ODT can be a "Don't Care". After the SELF REFRESH entry command is registered, CKE must be held LOW to keep the SDRAM in SELF REFRESH mode.

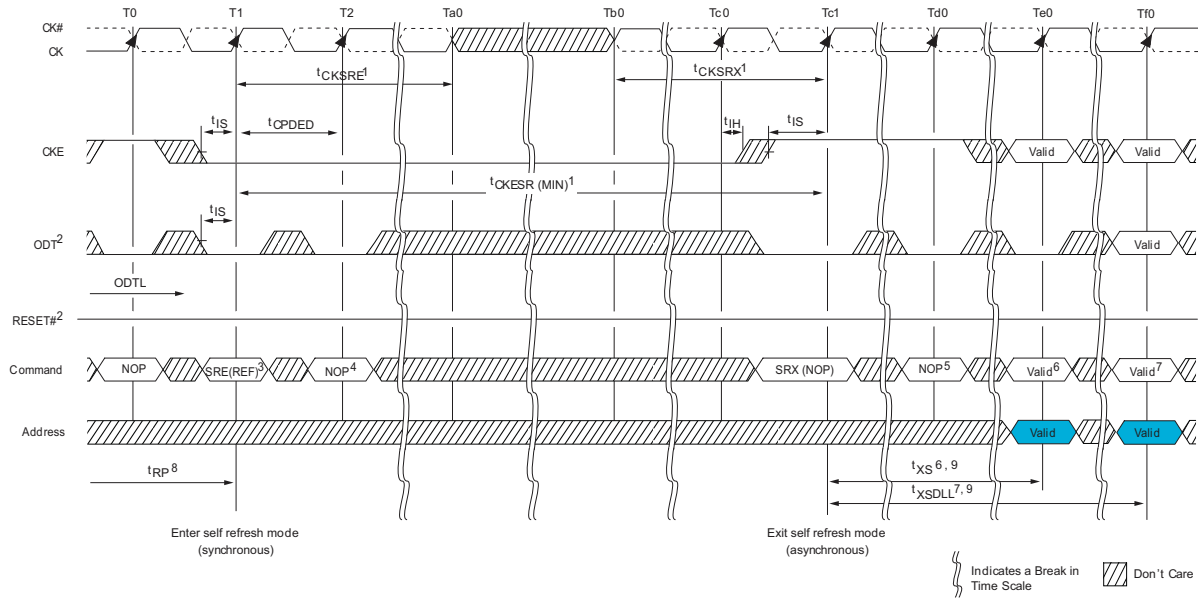
After the SDRAM has entered SELF REFRESH mode, all external control signals, except CKE and RESET $\bar{}$ , become "Don't Care". The SDRAM initiates a minimum of one REFRESH command internally within the  $t_{CKE}$  period when it enters SELF REFRESH mode.

The requirements for entering and exiting SELF REFRESH mode depend on the state of the clock during SELF REFRESH mode. First and foremost, the clock must be stable (meeting  $t_{CK}$  specifications) when SELF REFRESH mode is entered. If the clock remains stable and the frequency is not altered while in SELF REFRESH mode, then the SDRAM is allowed to exit SELF REFRESH after  $t_{CKESR}$  is satisfied (CKE is allowed to transition HIGH  $t_{CKESR}$  later than when CKE was registered LOW). Since the clock remains stable in SELF REFRESH mode (no frequency change),  $t_{CKSRE}$  and  $t_{CKSRX}$  are not required. However, if the clock is altered during SELF REFRESH mode, then  $t_{CKSRE}$  and  $t_{CKSRX}$  must be satisfied. When entering SELF REFRESH,  $t_{CKSRE}$  must be satisfied prior to altering the clock's frequency. Prior to exiting SELF REFRESH,  $t_{CKSRX}$  must be satisfied prior to registering CKE HIGH.

When CKE is HIGH during SELF REFRESH exit, NOP or DES must be issued for  $t_{XS}$  time.  $t_{XS}$  is required for the completion of any internal REFRESH that is already in progress and must be satisfied before a valid command not requiring a locked DLL can be issued to the device.  $t_{XS}$  is also the earliest time that a SELF REFRESH re-entry may occur (see Figure 87). Before a command requiring a locked DLL can be applied, a ZQCL command must be issued.  $t_{ZQOPER}$  timing must be met and  $t_{XSDLL}$  must be satisfied. ODT must be off during  $t_{XSDLL}$ .

**16-32 Gb, DDR3, 256-512M x 32 Dual Channel Memory Module**

**FIGURE 87 - SELF REFRESH ENTRY/EXIT TIMING**



- Notes:
1. The clock must be valid and stable meeting  $t_{CK}$  specifications at least  $t_{CKSRE}$  after entering self refresh mode, and at least  $t_{CKSRX}$  prior to exiting self refresh mode, if the clock is stopped or altered between states Ta0 and Tb0. If the clock remains valid and unchanged from entry and during self refresh mode, then  $t_{CKSRE}$  and  $t_{CKSRX}$  do not apply; however,  $t_{CKESR}$  must be satisfied prior to exiting at SRX.
  2. ODT must be disabled and RTT off prior to entering self refresh at state T1. If both RTT\_NOM and RTT\_WR are disabled in the mode registers, ODT can be a "Don't Care."
  3. Self refresh entry (SRE) is synchronous via a REFRESH command with CKE LOW.
  4. A NOP or DES command is required at T2 after the SRE command is issued prior to the inputs becoming "Don't Care."
  5. NOP or DES commands are required prior to exiting self refresh mode until state Te0.
  6.  $t_{XS}$  is required before any commands not requiring a locked DLL.
  7.  $t_{XSDLL}$  is required before any commands requiring a locked DLL.
  8. The device must be in the all banks idle state prior to entering self refresh mode. For example, all banks must be precharged,  $t_{RP}$  must be met, and no data bursts can be in progress.
  9. Self refresh exit is asynchronous; however,  $t_{XS}$  and  $t_{XSDLL}$  timings start at the first rising clock edge where CKE HIGH satisfies  $t_{ISXR}$  at Tc1.  $t_{CKSRX}$  timing is also measured so that  $t_{ISXR}$  is satisfied at Tc1.

## 16-32 Gb, DDR3, 256-512M x 32 Dual Channel Memory Module

### EXTENDED TEMPERATURE USAGE

LOGIC Devices, Inc iMOD DDR3 SDRAM module supports the optional extended temperature range up to  $\leq 95^{\circ}\text{C}$  while supporting SELF REFRESH/AUTO REFRESH and support  $T_A$  temperatures  $>95^{\circ}\text{C} \leq 125^{\circ}\text{C}$  with MANUAL REFRESH only. When using SELF REFRESH/AUTO REFRESH and the ambient temperature is  $>85^{\circ}\text{C}$ , SRT and ASR options must be used.

The extended range temperature range SDRAM must be REFRESHED externally at 2X anytime the ambient temperature is  $>85^{\circ}\text{C}$ . The external REFRESHING requirement is accomplished by reducing the REFRESH PERIOD from 64ms to 32ms. SELF REFRESH mode requires the use of ASR or SRT to support the extended temperature.

**TABLE 63: SELF REFRESH TEMPERATURE AND AUTO SELF REFRESH DESCRIPTION**

Field	MR2 Bits	Description
<b>Self Refresh Temperature (SRT)</b>		
<b>SRT</b>	7	If ASR is disabled (MR2[6]=0), SRT must be programmed to indicate <sup>t</sup> OPER during SELF REFRESH; * MR2[7] = 0: Normal operating temperature range ( $0^{\circ}\text{C}$ to $\leq 85^{\circ}\text{C}$ ) * MR2[7] = 1: Extended operating temperature range ( $>85^{\circ}\text{C}$ to $\leq 105^{\circ}\text{C}$ )  If ASR is enabled (MR2[7]=1), SRT must be set to 0, even if the extended temperature range is supported. *MR2[7]=0: SRT is disabled.
<b>Auto Self Refresh (ASR)</b>		
<b>ASR</b>	6	When ASR is enabled, the SDRAM automatically provides SELF REFRESH power management functions, (refresh rate for all supported operating temperature values) *MR2[6]=1: ASR is enabled (M7 must = 0)  When ASR is not enabled, the SRT bit must be programmed to indicate <sup>t</sup> OPER during SELF REFRESH operation. *MR2[6]=0: ASR is disabled, must use manual SELF REFRESH (SRT)

**TABLE 64: SELF REFRESH MODE SUMMARY**

MR2[6] (ASR)	MR2[7] (SRT)	SELF REFRESH Operation	Permitted Operating Temperature Range for Self Refresh Mode
0	0	SELF REFRESH Mode is supported in the normal temperature range.	Normal ( $0^{\circ}\text{C}$ to $85^{\circ}\text{C}$ )
0	1	SELF REFRESH Mode is supported in normal and extended ( $\leq 95^{\circ}\text{C}$ MAX) temperature ranges; When SRT is enabled, it increases self refresh power consumption.	Normal and extended ( $0^{\circ}\text{C}$ to $95^{\circ}\text{C}$ )
1	0	Self refresh mode is supported in normal and extended temperature ranges; Self refresh power consumption may be temperature-dependent.	Normal and extended ( $0^{\circ}\text{C}$ to $95^{\circ}\text{C}$ )
1	1	Illegal.	

### POWER-DOWN MODE

Power-down is synchronously entered when CKE is registered LOW coincident with a NOP or DES command. CKE is not allowed to go LOW while either an MRS, MPR, ZQCAL, READ or WRITE operation is in progress. CKE is allowed to go LOW while any of the other legal operations are in progress. However, the POWER-DOWN  $I_{DD}$  specifications are not applicable until such operations have been completed. Depending on the previous SDRAM state and the command issued prior to CKE going LOW, certain timing constraints must be satisfied (as noted in Table 65). Timing diagrams detailing the different POWER-DOWN mode entry and exits are shown in Figure 88 through Figure 97.

## 16-32 Gb, DDR3, 256-512M x 32 Dual Channel Memory Module

**TABLE 65: COMMAND TO POWER-DOWN ENTRY PARAMETERS**

SDRAM Status	Last Command prior to CKE Low <sup>1</sup>	Parameter (MIN)	Parameter Value	Figure
Idle or Active	ACTIVATE	<sup>t</sup> ACTPDEN	1 <sup>t</sup> CK	Figure 95
Idle or Active	PRECHARGE	<sup>t</sup> PRPDEN	1 <sup>t</sup> CK	Figure 96
Active	READ or READAP	<sup>t</sup> RDPDEN	RL = 4 <sup>t</sup> CK + 1 <sup>t</sup> CK	Figure 91
Active	WRITE: BL8OTF, BL8MRS, BC4OTF	<sup>t</sup> WRPDEN	WL + 4 <sup>t</sup> CK + <sup>t</sup> WR/ <sup>t</sup> CK	Figure 92
Active	WRITE: BC4MRS	<sup>t</sup> WRAPDEN	WL + 2 <sup>t</sup> CK + <sup>t</sup> WR/ <sup>t</sup> CK	Figure 92
Active	WRITEAP: BL8OTF, BL8MRS, BC4OTF		WL + 4 <sup>t</sup> CK + WR + 1 <sup>t</sup> CK	Figure 93
Active	WRITEAP: BC4MRS		WL + 2 <sup>t</sup> CK + WR + 1 <sup>t</sup> CK	Figure 93
Idle	REFRESH	<sup>t</sup> REFPDEN	1 <sup>t</sup> CK	Figure 94
POWER-DOWN	REFRESH	<sup>t</sup> XPDLL	Greater of 10 <sup>t</sup> CK or 24ns	Figure 98
Idle	MODE REGISTER SET	<sup>t</sup> MRSPDEN	<sup>t</sup> MOD	Figure 97

Entering POWER-DOWN mode disables the input and output buffers, excluding CK, CK\, ODT, CKE and RESET\ . NOP or DES commands are required until <sup>t</sup>CPDED has been satisfied, at which time all specified input/output buffers will be disabled. The DLL should be in a locked state when POWER-DOWN is entered for the fastest mode timing. If the DLL is not locked during the POWER-DOWN entry, the DLL must be reset after exiting POWER-DOWN for proper READ operation as well as synchronous ODT operation.

During POWER-DOWN entry, if any bank remains open after all in-progress commands are complete, the SDRAM will be in ACTIVE POWER-DOWN. If all banks are closed after all in-progress commands are complete, the SDRAM will be in PRECHARGE POWER-DOWN mode or fast EXIT mode. When entering PRECHARGE POWER-DOWN, the DLL is turned off in slow exit mode or kept on in fast EXIT mode.

The DLL remains on when entering ACTIVE POWER-DOWN as well. ODT has special timing constraints when slow EXIT mode, PRECHARGE POWER-DOWN is enabled and entered. Refer to "Asynchronous ODT Mode" for detailed ODT usage requirements in slow EXIT mode PRECHARGE POWER-DOWN. A summary of the two POWER-DOWN modes is listed in Table 66.

While in either POWER-DOWN state, CKE is held LOW, RESET\ is held HIGH, and a stable clock signal must be maintained. ODT must be in a valid state but all other input signals are a "Don't Care". If RESET\ goes LOW during POWER-DOWN, the SDRAM will switch out of POWER-DOWN and go into the RESET state. After CKE is registered LOW, CKE must remain LOW until <sup>t</sup>PD (MIN) has been satisfied. The maximum time allowed for POWER-DOWN duration is <sup>t</sup>PD (MAX) (9 x <sup>t</sup>REFI).

The POWER-DOWN states are synchronously exited when CKE is registered HIGH (with a required NOP or DES command). CKE must be maintained HIGH until <sup>t</sup>CKE has been satisfied. A valid, executable command may be applied after POWER-DOWN EXIT LATENCY, <sup>t</sup>XP, <sup>t</sup>XPDLL have been satisfied. A summary of the POWER-DOWN modes is listed in Table 66.

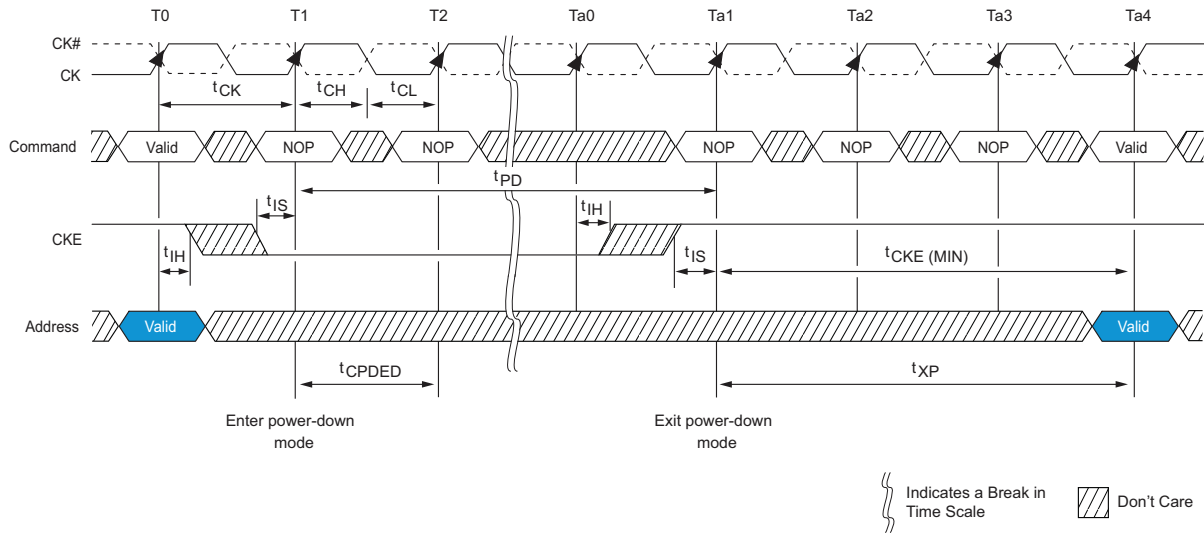
**TABLE 66: POWER-DOWN MODES**

SDRAM State	MR1[12]	DLL State	POWER-DOWN exit	Relevant Parameters
ACTIVE (any bank open)	"Don't Care"	ON	FAST	<sup>t</sup> XP to any other valid COMMAND
PRECHARGE (all banks PRECHARGED)	1	ON	FAST	<sup>t</sup> XP to any other valid COMMAND
	0	OFF	SLOW	<sup>t</sup> XDLL to COMMANDS that require the DLL to be locked (READ, RDAP, ODT ON). <sup>t</sup> XP to any other valid COMMAND.

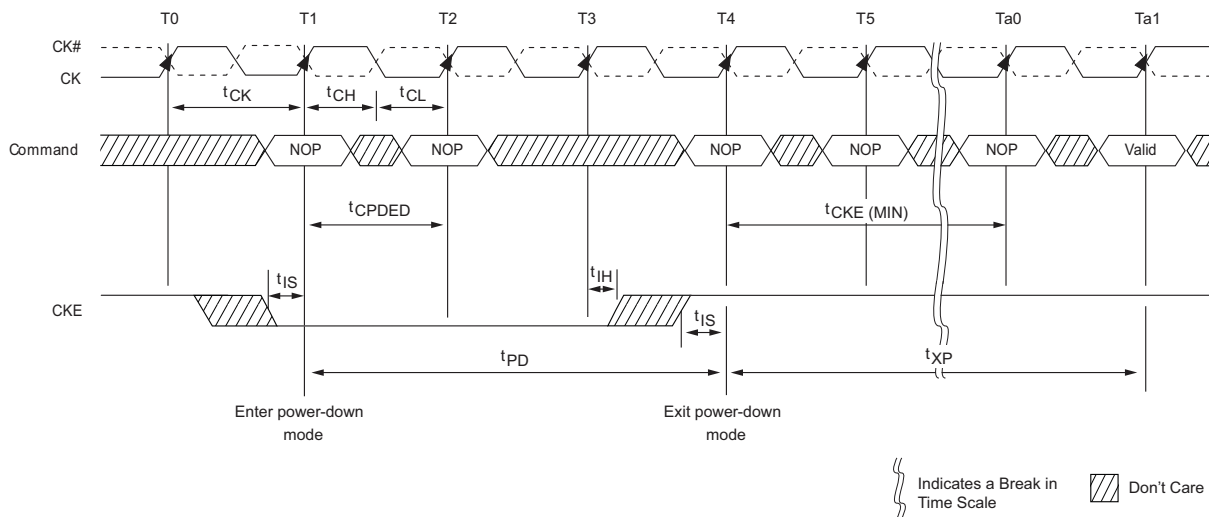


**16-32 Gb, DDR3, 256-512M x 32 Dual Channel Memory Module**

**FIGURE 88 - ACTIVE POWER-DOWN ENTRY AND EXIT**

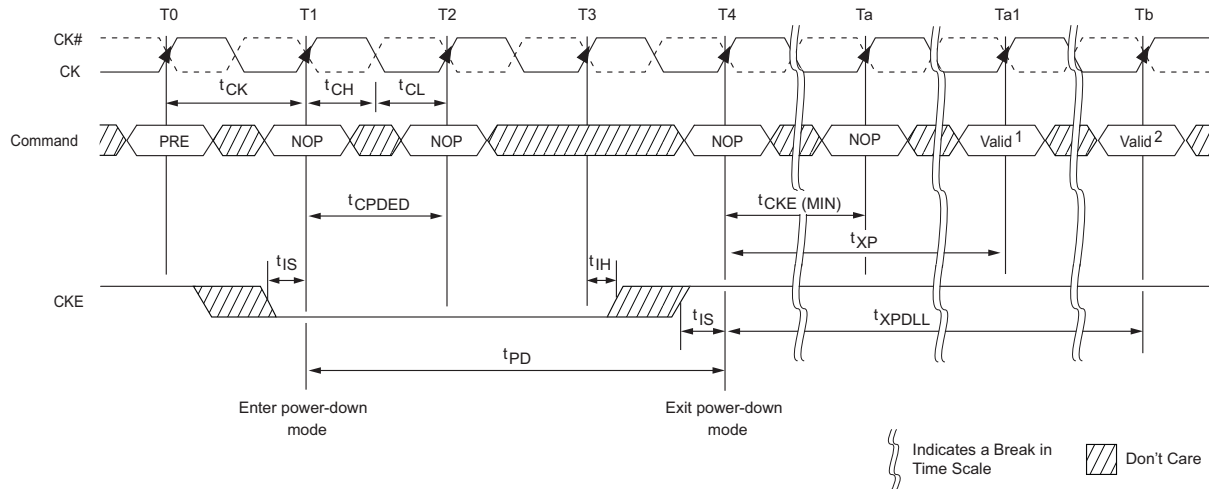


**FIGURE 89 - PRECHARGE POWER-DOWN (FAST-EXIT MODE) ENTRY AND EXIT**



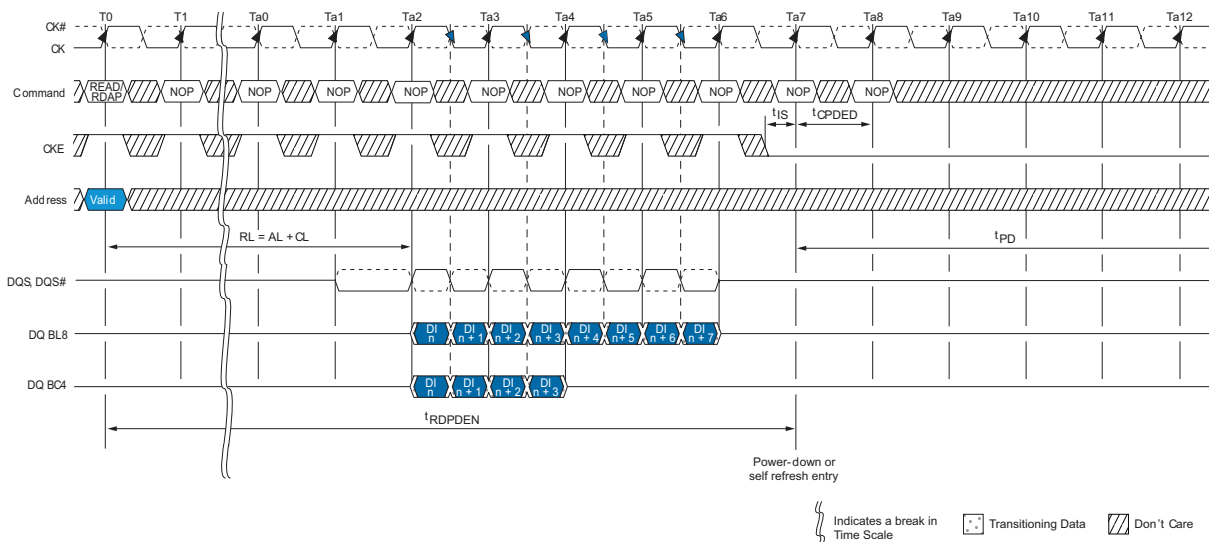
**16-32 Gb, DDR3, 256-512M x 32 Dual Channel Memory Module**

**FIGURE 90 - PRECHARGE POWER-DOWN (SLOW-EXIT MODE) ENTRY AND EXIT**



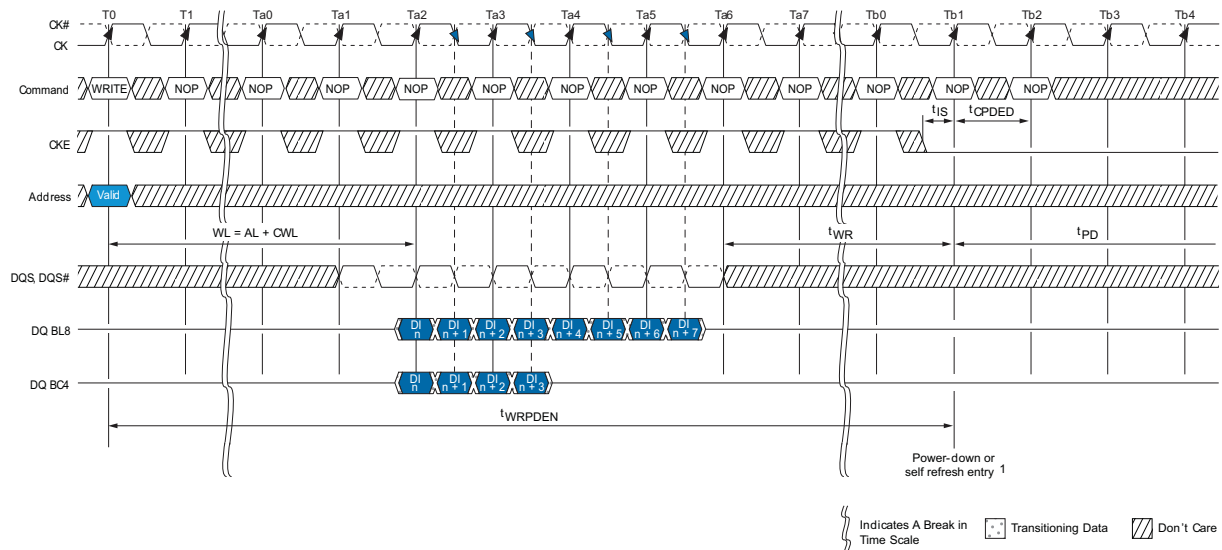
- Notes: 1. Any valid command not requiring a locked DLL.  
2. Any valid command requiring a locked DLL.

**FIGURE 91 - POWER-DOWN ENTRY AFTER READ OR READ WITH AUTO PRECHARGE (RDAP)**



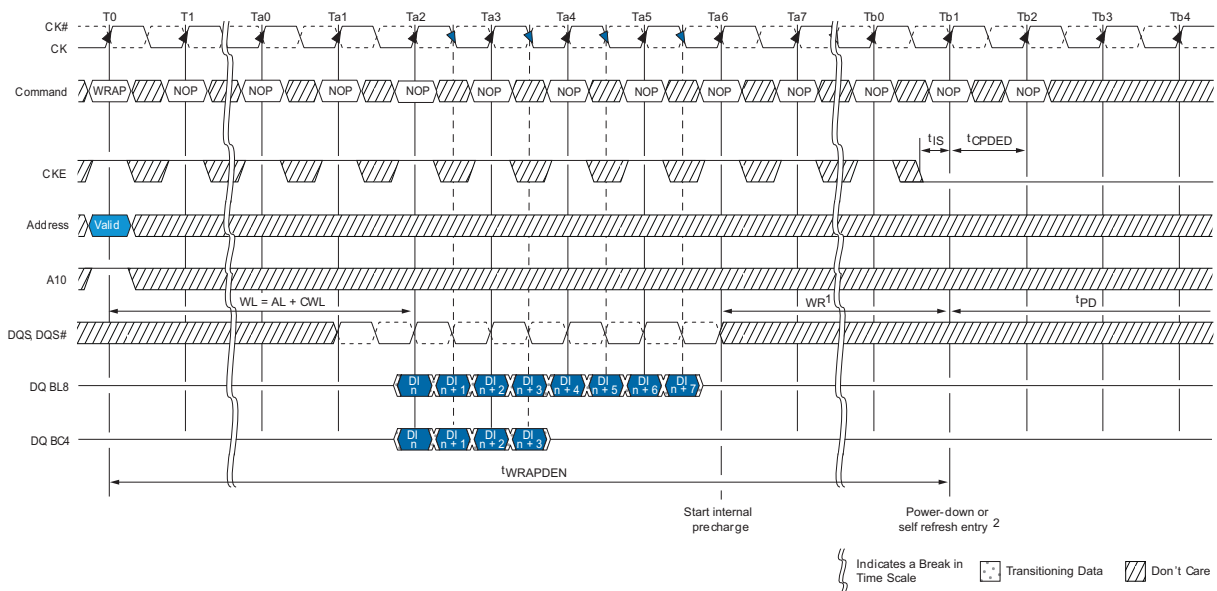
**16-32 Gb, DDR3, 256-512M x 32 Dual Channel Memory Module**

**FIGURE 92 - POWER-DOWN ENTRY AFTER WRITE**



Notes: 1. CKE can go LOW  $2^t\text{CK}$  earlier if BC4MRS.

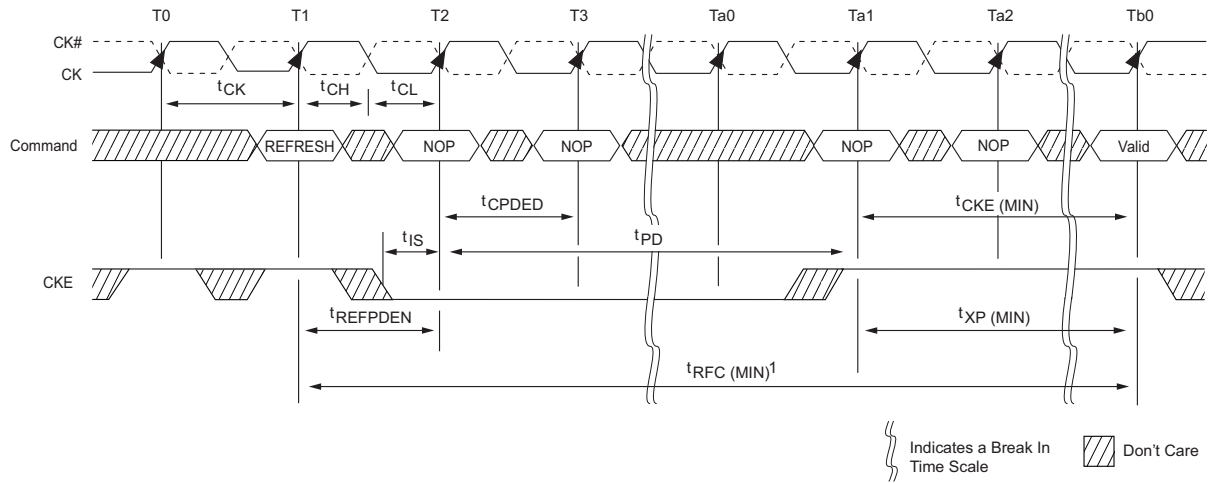
**FIGURE 93 - POWER-DOWN ENTRY AFTER WRITE WITH AUTO PRECHARGE (WRAP)**



Notes: 1.  $t\text{WR}$  is programmed through MR0[11:9] and represents  $t\text{WR} (\text{MIN})/n_s / t\text{CK}$  rounded up to the next integer  $t\text{CK}$ .  
2. CKE can go LOW  $2^t\text{CK}$  earlier if BC4MRS.

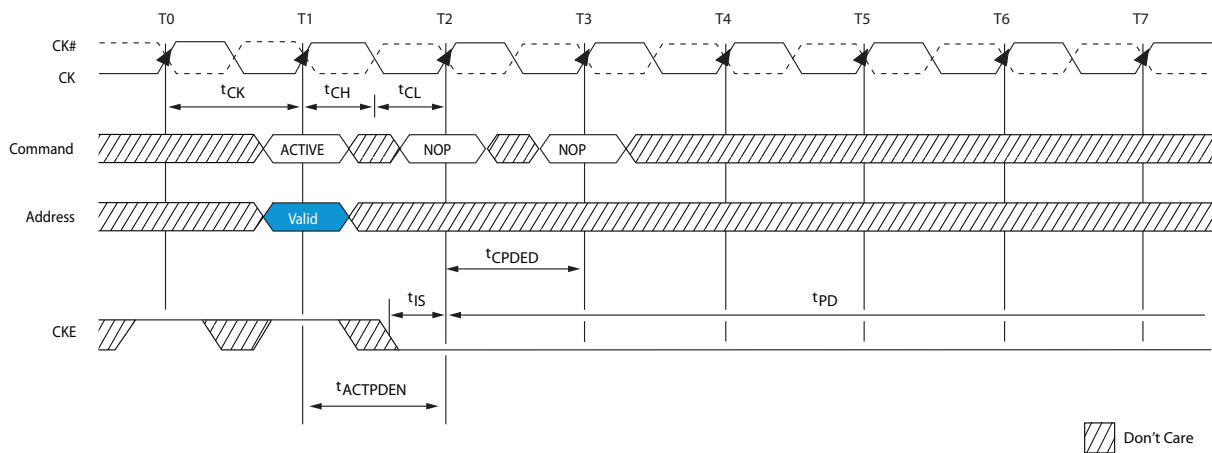
**16-32 Gb, DDR3, 256-512M x 32 Dual Channel Memory Module**

**FIGURE 94 - REFRESH TO POWER-DOWN ENTRY**



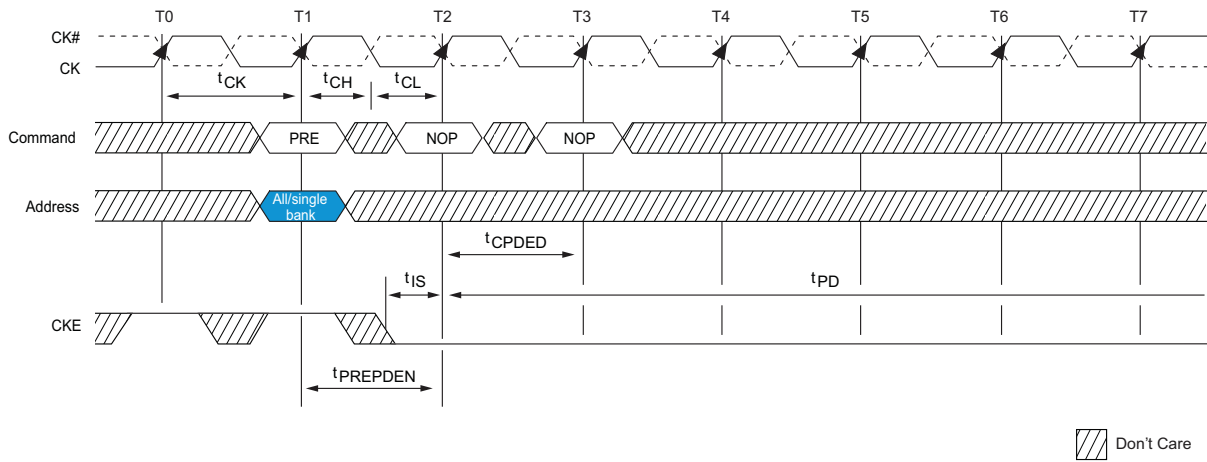
Notes: 1. After CKE goes HIGH during  $t_{RFC}$ , CKE must remain HIGH until  $t_{RFC}$  is satisfied.

**FIGURE 95 - ACTIVATE TO POWER-DOWN ENTRY**

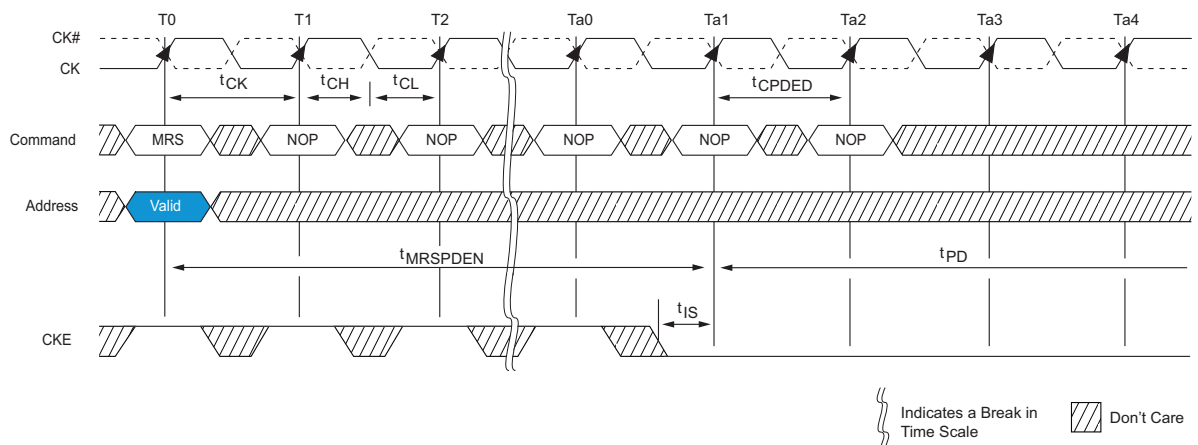


**16-32 Gb, DDR3, 256-512M x 32 Dual Channel Memory Module**

**FIGURE 96 - PRECHARGE TO POWER-DOWN ENTRY**

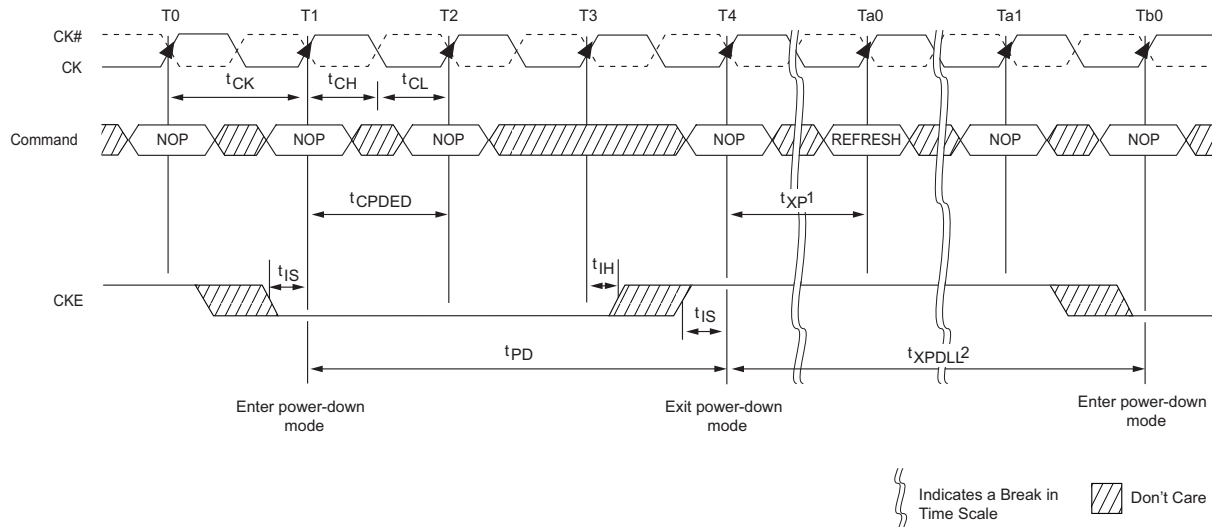


**FIGURE 97 - MRS COMMAND TO POWER-DOWN ENTRY**



**16-32 Gb, DDR3, 256-512M x 32 Dual Channel Memory Module**

**FIGURE 98 - POWER-DOWN EXIT TO REFRESH TO POWER-DOWN ENTRY**



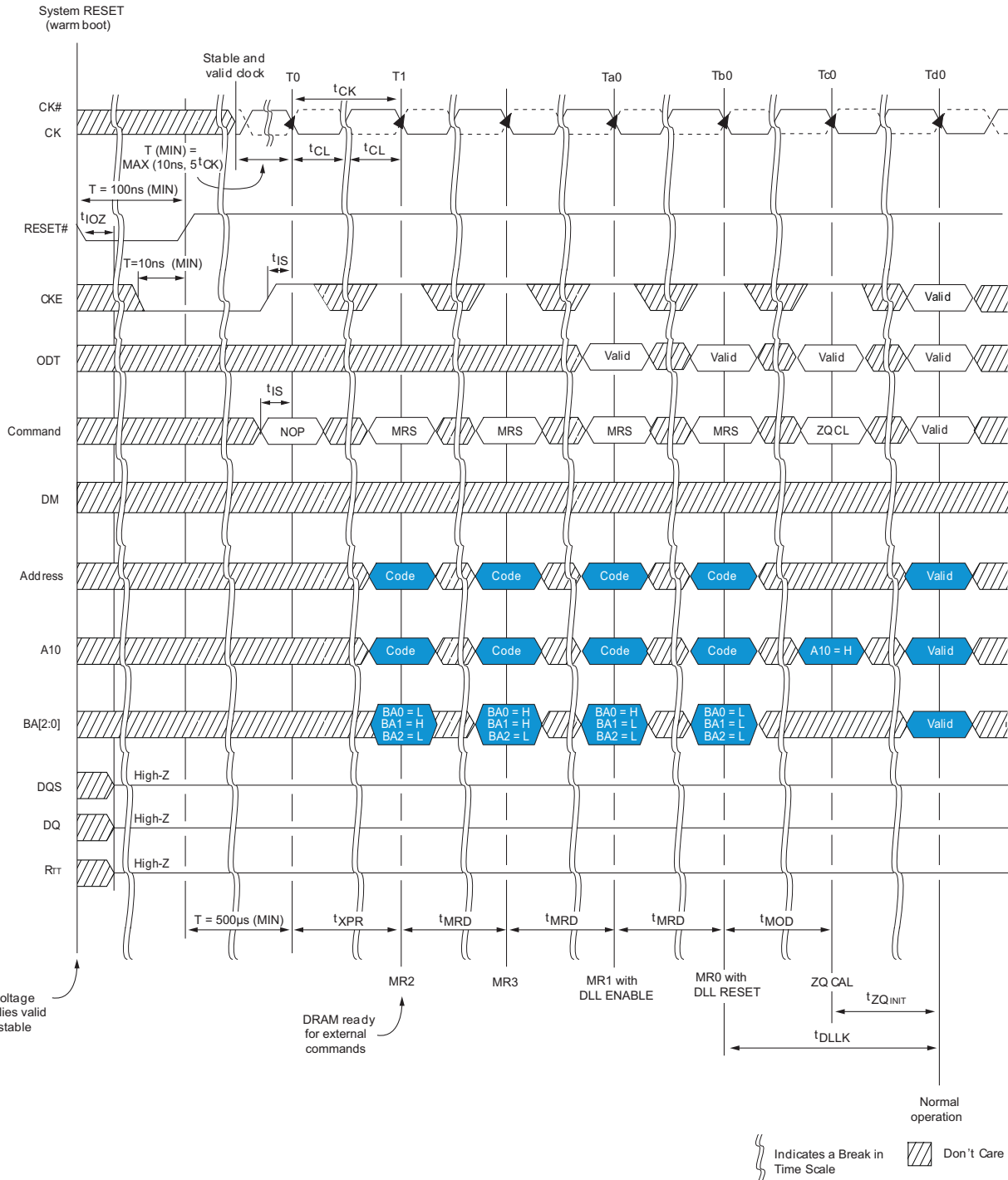
- Notes:
1.  $t_{XP}$  must be satisfied before issuing the command.
  2.  $t_{XPDLL}$  must be satisfied (referenced to the registration of power-down exit) before the next power-down can be entered.

**RESET**

The RESET signal (RESET) is an asynchronous signal that triggers any time it drops LOW and there are no restrictions about when it can go LOW. After RESET is driven LOW, it must remain LOW for 100ns. During this time, the outputs are disabled, ODT (RTT) turns off (HIGH-Z) and the DDR3 SDRAM resets itself. CKE should be brought LOW prior to RESET being driven HIGH. After RESET goes HIGH, the SDRAM must be re-initialized as though a normal power up were executed (see Figure 99). All refresh counters on the SDRAM are RESET and data stored in the SDRAM is assumed unknown after RESET has been driven LOW.

**16-32 Gb, DDR3, 256-512M x 32 Dual Channel Memory Module**

**FIGURE 99 - RESET SEQUENCE**



**16-32 Gb, DDR3, 256-512M x 32 Dual Channel Memory Module**

**ON-DIE TERMINATION (ODT)**

ODT is a feature that enables the SDRAM to enable/disable on-die termination resistance for each DQ, LDQSx, LDQSx\ , UDQSx, UDQSx\ LDMx and UDMx for the four words contained in LDI's DDR3 iMOD.

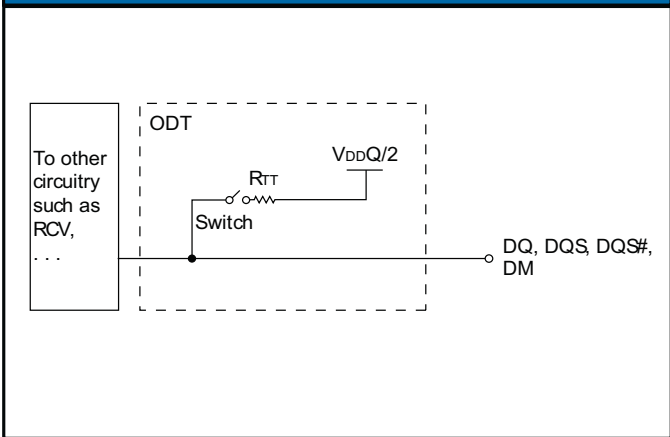
The ODT feature is designed to improve signal integrity of the memory array/sub-system by enabling the DDR3 memory controller to independently turn on or off the SDRAMs internal termination resistance for any grouping of SDRAM devices. The ODT feature is not supported during DLL disable mode. A simple functional representation of the SDRAM ODT feature is shown in Figure 100. The switch is enabled by the internal ODT control logic, which uses the external ODT ball and other control information.

**FUNCTIONAL REPRESENTATION OF ODT**

The value of R<sub>TT</sub> (ODT termination value) is determined by the settings of several mode register bits (see Table 70). The ODT ball is ignored while in SELF REFRESH mode (must be turned off prior to SELF REFRESH entry) or if mode registers MR1 and MR2 are programmed to disable ODT. ODT is comprised of nominal ODT and dynamic ODT modes and either of these can function in synchronous or asynchronous modes (when the DLL is off during PRECHARGE POWER-DOWN or when the DLL is synchronizing). Nominal ODT is the base termination and is used in any allowable ODT state. Dynamic ODT is applied only during WRITES and provides OTF switching from no R<sub>TT</sub> or R<sub>TT\_NOM</sub> to R<sub>TT\_WR</sub>.

The actual effective termination, R<sub>TT\_EFF</sub> may be different from the R<sub>TT</sub> targeted due to nonlinearity of the termination. For R<sub>TT\_EFF</sub> values and calculations, see "ODT Characteristics".

**FIGURE 100 - ON-DIE TERMINATION**



**NOMINAL ODT**

ODT (NOM) is the base termination resistance for each applicable ball, enabled or disabled via MR1[9,6,2] (see Figure 46), and it is turned on or off via the ODT ball.

**TABLE 67: POWER-DOWN MODES**

MR1[9,6,2]	ODT Pin	SDRAM Termination State	SDRAM State	Notes
000	0	R <sub>TT_NOM</sub> disabled, ODT OFF	Any valid	1,2
000	1	R <sub>TT_NOM</sub> disabled, ODT ON	Any valid except SELF REFRESH, READ	1,3
000-101	0	R <sub>TT_NOM</sub> enabled, ODT OFF	Any valid	1,2
000-101	1	R <sub>TT_NOM</sub> enabled, ODT ON	Any valid except SELF REFRESH, READ	1,3
110 and 111	X	R <sub>TT_NOM</sub> reserved, ODT ON or OFF	Illegal	

NOTES:

- Assumes dynamic ODT is disabled.
- ODT is enabled and active during most WRITES for proper termination, but it is not illegal to have it off during WRITES.
- ODT must be disabled during READs. The R<sub>TT\_NOM</sub> value is restricted during WRITES. Dynamic ODT is applicable if enabled.



## 16-32 Gb, DDR3, 256-512M x 32 Dual Channel Memory Module

### NOMINAL ODT

Nominal ODT resistance  $R_{TT\_NOM}$  is defined by MR1[9,6,2], as shown in Figure 46. The  $R_{TT\_NOM}$  termination value applies to the output pins previously mentioned. DDR3 SDRAM iMODs support multiple  $R_{TT\_NOM}$  values based on RZQ/n where n can be 2,4,6,8 or 12 and RZQ is  $240\Omega \pm 1\%$ .  $R_{TT\_NOM}$  termination is allowed any time after the SDRAM is initialized, calibrated and not performing READ accesses or when it is not in SELF REFRESH mode.

WRITE access uses  $R_{TT\_NOM}$  if dynamic ODT ( $R_{TT\_WR}$ ) is disabled. If  $R_{TT\_NOM}$  is used during WRITES, only RZQ/2, RZQ/4 and RZQ/6 are allowed (see Table 66). ODT timings are summarized in Table 68, as well as, listed in Table 47.

Examples of nominal ODT timing are shown in conjunction with the synchronous mode of operation in “Synchronous ODT Mode”.

**TABLE 68: ODT PARAMETER**

Symbol	Description	Begins at	Defined to	Definition for All DDR3 bins	Units
ODTL ON	ODT synchronous turn on delay	ODT registered HIGH	$R_{TT\_ON} \pm t_{AON}$	$CWL + AL - 2$	tCK
ODTL OFF	ODT synchronous turn off delay	ODT registered HIGH	$R_{TT\_ON} \pm t_{AOF}$	$CWL + AL - 2$	tCK
$t_{AONPD}$	ODT asynchronous on delay	ODT registered HIGH	$R_{TT\_ON}$	1-9	ns
$t_{AOFFPD}$	ODT asynchronous on delay	ODT registered HIGH	$R_{TT\_OFF}$	1-9	ns
ODTH4	ODT minimum HIGH time after ODT assertion or WRITE (BC4)	ODT registered HIGH or WRITE registration with ODT HIGH	ODT registered LOW	4tCK	tCK
ODTH8	ODT minimum HIGH time after WRITE (BL8)	WRITE registration with ODT HIGH	ODT registered LOW	6tCK	tCK
$t_{AON}$	ODT turn-on relative to ODTL on completion	Completion of ODTL on	$R_{TT\_ON}$	See Table 47	ps
$t_{AOF}$	ODT turn-off relative to ODTL off completion	Completion of ODTL off	$R_{TT\_OFF}$	$0.5tCK \pm 0.2tCK$	tCK

### DYNAMIC ODT

In certain applications, to further enhance signal integrity on the data bus, it is desirable that the termination strength, be changed without issuing an MRS command, essentially changing the ODT termination resistance on-the-fly. With dynamic ODT ( $R_{TT\_WR}$ ) enabled, the SDRAM switches from nominal ODT ( $R_{TT\_NOM}$ ) to dynamic ODT when beginning a WRITE burst and subsequently switches back to nominal ODT at the completion of the WRITE burst sequence. This requirement and the supporting DYNAMIC ODT feature of the DDR3 SDRAM makes it feasible and is described in further detail below:

#### DYNAMIC ODT FUNCTIONAL DESCRIPTION:

The dynamic ODT mode is enabled if either MR2[9] or mR2[10] is set to “1”. Dynamic ODT is not supported during DLL disable mode, so  $R_{TT\_WR}$  must be disabled. The dynamic ODT function is described, as follows:

- Two  $R_{TT}$  values are available –  $R_{TT\_NOM}$  and  $R_{TT\_WR}$ :
  - The value of  $R_{TT\_NOM}$  is preselected via MR1[9,6,2]
  - The value for  $R_{TT\_WR}$  is preselected via MR2[10,9]
- During SDRAM operations without READ or WRITE commands, the termination is controlled as follows:
  - Termination ON/OFF timing is controlled via the ODT ball and LATENCIES ODTI on and ODTL off
  - Nominal termination strength  $R_{TT\_NOM}$  is used
- When a WRITE command (WR, WRAP, WRS4, WRS8, WRAPS4, WRAPS8) is registered and if dynamic ODT is enabled, the ODT termination is controlled as follows:
  - A latency of ODTLCNW after the WRITE command: termination strength  $R_{TT\_NOM}$  switches to  $R_{TT\_WR}$
  - A Latency of ODTLCWN8 (for BL8, fixed or OTF) or ODTLCWN4 (for BC4, fixed or OTF) after the WRITE command: termination strength  $R_{TT\_WR}$  switches back to  $R_{TT\_NOM}$
  - ON/OFF termination timing is controlled via the ODT ball and determined by ODTL on, ODTL off, ODTH4 and ODTH8.
  - During the  $t_{ADC}$  transition window, the value of  $R_{TT}$  is undefined

ODT is constrained during WRITES and when dynamic ODT is enabled (see Table 69).

## 16-32 Gb, DDR3, 256-512M x 32 Dual Channel Memory Module

**TABLE 69: DYNAMIC ODT SPECIFIC PARAMETERS**

Symbol	Description	Begins at	Defined to	Definition for All DDR3 bins	Units
ODTL <sub>CNV</sub>	Change from RTT_NOM to RTT_WR	WRITE registration	RTT switched from RTT_NOM to RTT_WR	WL - 2	<sup>t</sup> CK
ODTL <sub>CWN4</sub>	Change from RTT_WR to RTT_NOM (BC4)	WRITE registration	RTT switched from RTT_WR to RTT_NOM	4 <sup>t</sup> CK + ODTL OFF	<sup>t</sup> CK
ODTL <sub>CWN8</sub>	Change from RTT_WR to RTT_NOM (BL8)	WRITE registration	RTT switched from RTT_WR to RTT_NOM	6 <sup>t</sup> CK + ODTL OFF	<sup>t</sup> CK
<sup>t</sup> ADC	RTT change skew	ODTL <sub>CNV</sub>	RTT trans complete	0.5 <sup>t</sup> CK ± 0.2 <sup>t</sup> CK	<sup>t</sup> CK

**TABLE 70: MODE REGISTERS FOR RTT\_NOM**

MR1(RTT_NOM)			RTT_NOM (RZQ)	RTT_NOM(Ohms)	RTT_NOM Mode Restriction
M9	M6	M2			
0	0	0	Off	Off	n/a
0	0	1	RZQ/4	60	SELF REFRESH
0	1	0	RZQ/2	120	
0	1	1	RZQ/6	40	
1	0	0	RZQ/12	20	SELF REFRESH, WRITE
1	0	1	RZQ/8	30	
1	1	0	Reserved	Reserved	n/a
1	1	1	Reserved	Reserved	n/a

**TABLE 71: MODE REGISTERS FOR RTT\_WR**

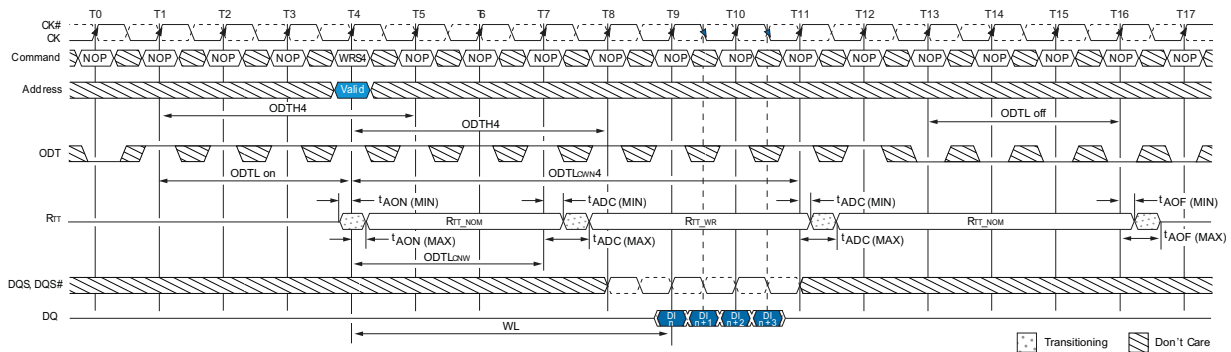
MR1(RTT_NOM)		RTT_NOM (RZQ)	RTT_NOM(Ohms)
M10	M2		
0	0	Dynamic ODT OFF: WRITE does not affect RTT_NOM	
0	1	RZQ/4	60
1	0	RZQ/2	120
1	1	Reserved	Reserved
n/a	n/a	n/a	n/a
n/a	n/a	n/a	n/a
n/a	n/a	n/a	n/a
n/a	n/a	n/a	n/a

**TABLE 72: TIMING DIAGRAMS FOR DYNAMIC ODT**

Figure	Title
Figure 101	Dynamic ODT: ODT asserted before and after the WRITE, BC4
Figure 102	Dynamic ODT: Without WRITE command
Figure 103	Dynamic ODT: ODT pin asserted together with WRITE command for 6 CK cycles, BL8
Figure 104	Dynamic ODT: ODT pin asserted with WRITE command for 6 CK cycles, BC4
Figure 105	Dynamic ODT: ODT pin asserted with WRITE command for 4 CK cycles, BC4

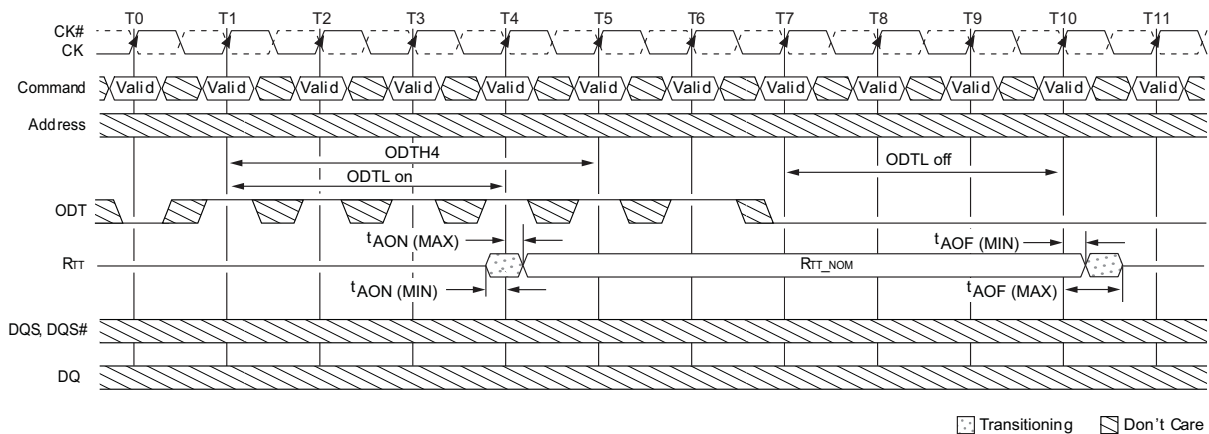
**16-32 Gb, DDR3, 256-512M x 32 Dual Channel Memory Module**

**FIGURE 101 - DYNAMIC ODT: ODT ASSERTED BEFORE AND AFTER THE WRITE, BC4**



- Notes:
1. Via MRS or OTF. AL = 0, CWL = 5. R<sub>TT\_NOM</sub> and R<sub>TT\_WR</sub> are enabled.
  2. O<sub>DT</sub>H4 applies to first registering O<sub>DT</sub> HIGH and then to the registration of the WRITE command. In this example, O<sub>DT</sub>H4 is satisfied if O<sub>DT</sub> goes LOW at T8 (four clocks after the WRITE command).

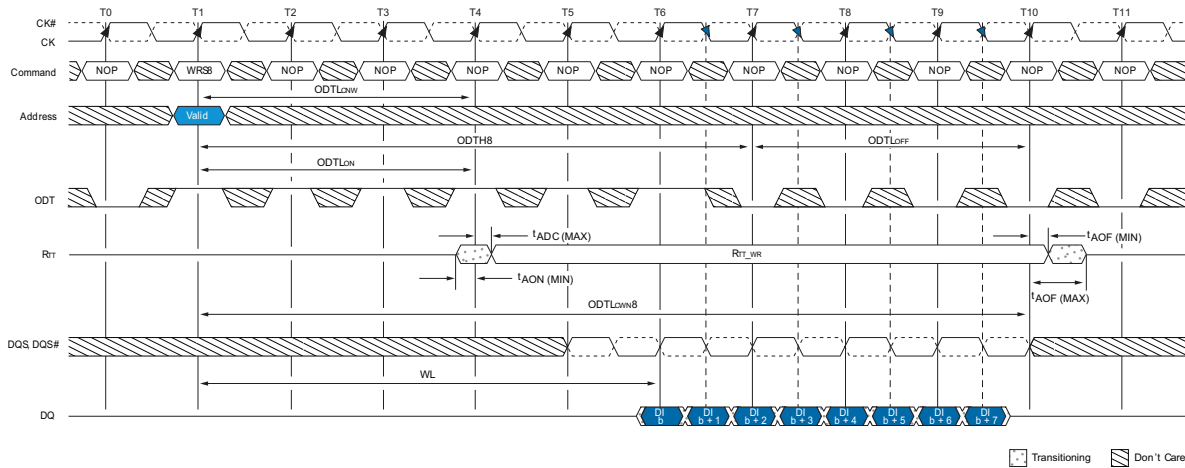
**FIGURE 102 - DYNAMIC ODT: WITHOUT WRITE COMMAND**



- Notes:
1. AL = 0, CWL = 5. R<sub>TT\_NOM</sub> is enabled and R<sub>TT\_WR</sub> is either enabled or disabled.
  2. O<sub>DT</sub>H4 is defined from O<sub>DT</sub> registered HIGH to O<sub>DT</sub> registered LOW; in this example, O<sub>DT</sub>H4 is satisfied. O<sub>DT</sub> registered LOW at T5 is also legal.

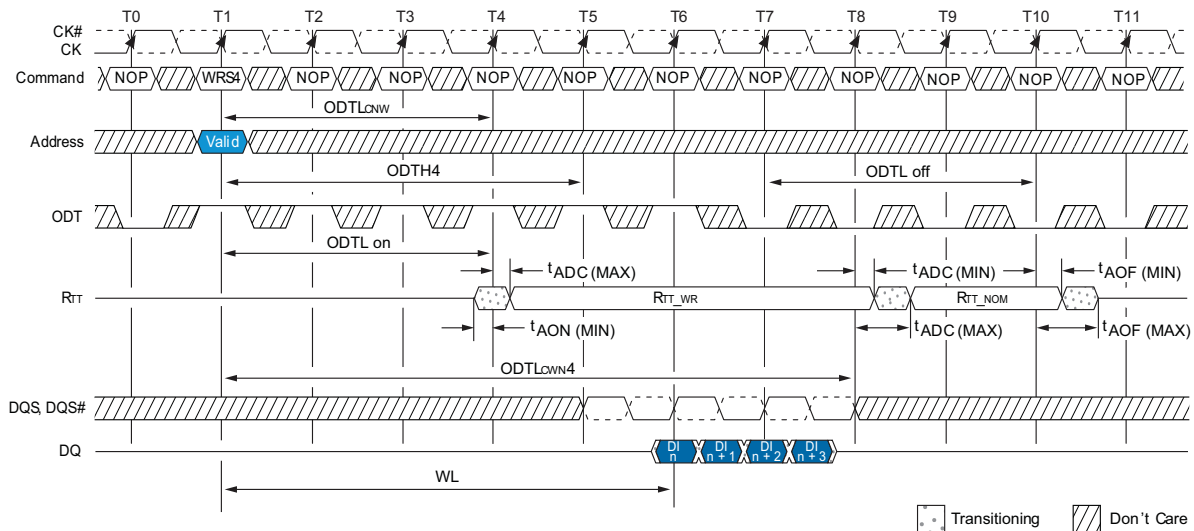
**16-32 Gb, DDR3, 256-512M x 32 Dual Channel Memory Module**

**FIGURE 103 - DYNAMIC ODT: ODT PIN ASSERTED TOGETHER WITH WRITE COMMAND FOR 6 CLOCK CYCLES, BL8**



- Notes: 1. Via MRS or OTF; AL = 0, CWL = 5. If RTT\_NOM can be either enabled or disabled, ODT can be HIGH. RTT\_WR is enabled.  
2. In this example, ODT<sub>H8</sub> = 6 is satisfied exactly.

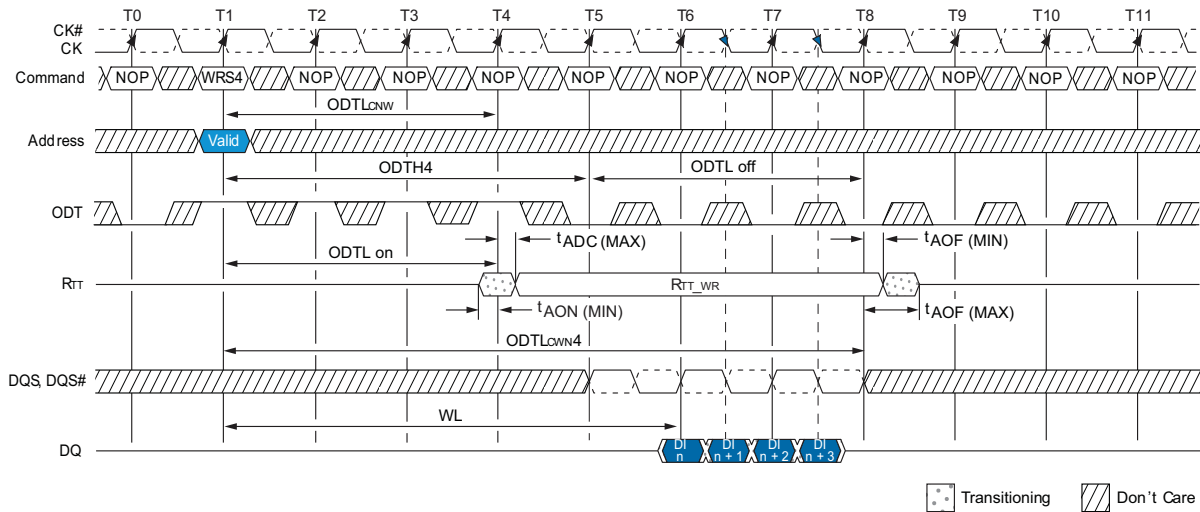
**FIGURE 104 - DYNAMIC ODT: ODT PIN ASSERTED WITH WRITE COMMAND FOR 6 CLOCK CYCLES, BC4**



- Notes: 1. Via MRS or OTF. AL = 0, CWL = 5. RTT\_NOM and RTT\_WR are enabled.  
2. ODT<sub>H4</sub> is defined from ODT registered HIGH to ODT registered LOW, so in this example, ODT<sub>H4</sub> is satisfied. ODT registered LOW at T5 is also legal.

**16-32 Gb, DDR3, 256-512M x 32 Dual Channel Memory Module**

**FIGURE 105 - DYNAMIC ODT: ODT P<sub>IN</sub> ASSERTED WITH WRITE COMMAND FOR 4 CLOCK CYCLES, BC4**



- Notes:
1. Via MRS or OTF. AL = 0, CWL = 5. R<sub>TT\_NOM</sub> can be either enabled or disabled. If disabled, ODT can remain HIGH. R<sub>TT\_WR</sub> is enabled.
  2. In this example ODT<sub>H4</sub> = 4 is satisfied exactly.

**SYNCHRONOUS ODT MODE**

Synchronous ODT is selected whenever the DLL is turned on and locked while R<sub>TT\_NOM</sub> or R<sub>TT\_WR</sub> is enabled. Based on the POWER-DOWN definition, these modes are:

- Any bank ACTIVE with CKE HIGH
- REFRESH mode with CKE HIGH
- DLE mode with CKE HIGH
- ACTIVE POWER-DOWN mode (regardless of MR0[12])
- PRECHARGE POWER-DOWN mode if DLL is enabled during PRECHARGE POWER-DOWN by MR0[12]

**ODT LATENCY AND POSTED ODT**

In synchronous ODT mode, R<sub>TT</sub> turns on ODTL on clock cycles after ODT is sampled HIGH by a rising clock edge and turns off ODTL off clock cycles after ODT is registered LOW by a rising clock edge. The actual on/off times varies by t<sub>AON</sub> and t<sub>AOF</sub> around each clock edge (see Table 73). The ODT LATENCY is tied to the WRITE LATENCY (WL) by ODTL on = WL - 2 and ODTL off = WL - 2.

Since WRITE LATENCY is made up of CAS WRITE LATENCY (CWL) and ADDITIVE LATENCY (AL), the AL value programmed into the mode register MR1[4,3], also applies to the ODT signal. The SDRAM's internal ODT signal is delayed a number of clock cycles defined by the AL relative to the external ODT signal. Thus, ODTL on = CWL + AL - 2 and ODTL off = CWL + AL - 2.

**16-32 Gb, DDR3, 256-512M x 32 Dual Channel Memory Module**

**SYNCHRONOUS ODT TIMING PARAMETERS**

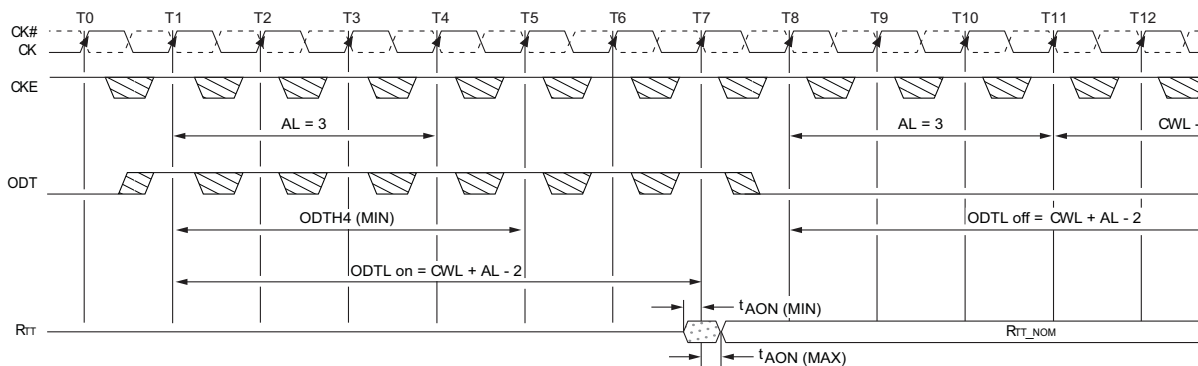
Synchronous ODT mode uses the following timing parameters: ODTL on, ODTL off, ODTH4, ODTH8, tAON and tAOF (see Table 73 and Figure 106). The minimum RTT turn-on time (tAON [MIN]) is the point at which the device leaves HIGH-A and ODT resistance begins to turn on. Maximum RTT turn-on time (tAON [MAX]) is the point at which ODT resistance is fully on. Both are measured relative to ODTL on. The minimum RTT turn-off time (tAOF [min]) is the point at which the device starts to turn-off ODT resistance. Maximum RTT turn-off time (tAOF [MAX]) is the point at which ODT has reached HIGH-Z. Both are measured from ODTL off.

When ODT is asserted, it must remain HIGH until ODTH4 is satisfied. If a WRITE command is registered by the SDRAM with ODT HIGH, then ODT must remain HIGH until ODTH4 (BC4) or ODTH8 (BL8) after the WRITE command (see Figure 107). ODTH4 and ODTH8 are measured from ODT registered HIGH to ODT registered LOW or from the registration of a WRITE command until ODT is registered LOW.

**TABLE 73: SYNCHRONOUS ODT PARAMETERS**

Symbol	Description	Begins at	Defined to	Definition for All DDR3 bins	Units
ODTL ON	ODT synchronous TURN-ON delay	ODT registered HIGH	RTT_ON ± tAON	CWL + AL - 2	tCK
ODTL OFF	ODT synchronous TURN-OFF delay	ODT registered HIGH	RTT_OFF ± tAOF	CWL + AL - 2	tCK
ODTH4	ODT Minimum HIGH time after ODT assertion or WRITE (BC4)	ODT registered HIGH, or WRITE registration with ODT HIGH	ODT registered LOW	4tCK	tCK
ODTH8	ODT Minimum HIGH time after WRITE (BL8)	WRITE registration with ODT HIGH	ODT registered LOW	6tCK	tCK
tAON	ODT TURN-ON relative to ODTL on completion	Completion of ODTL on	RTT_ON	See Table 47	ps
tAOF	ODT TURN-OFF relative to ODTL off completion	Completion of ODTL off	RTT_OFF	0.5tCK ± 0.2tCK	tCK

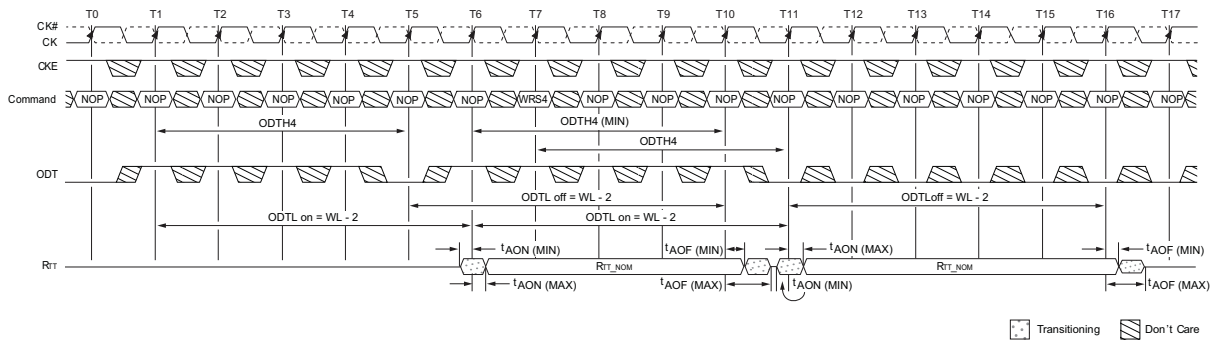
**FIGURE 106 - SYNCHRONOUS ODT**



Notes: 1. AL = 3; CWL = 5; ODTL on = WL = 6.0; ODTL off = WL - 2 = 6. Rtt\_NOM is enabled.

16-32 Gb, DDR3, 256-512M x 32 Dual Channel Memory Module

**FIGURE 107 - SYNCHRONOUS ODT (BC4)**

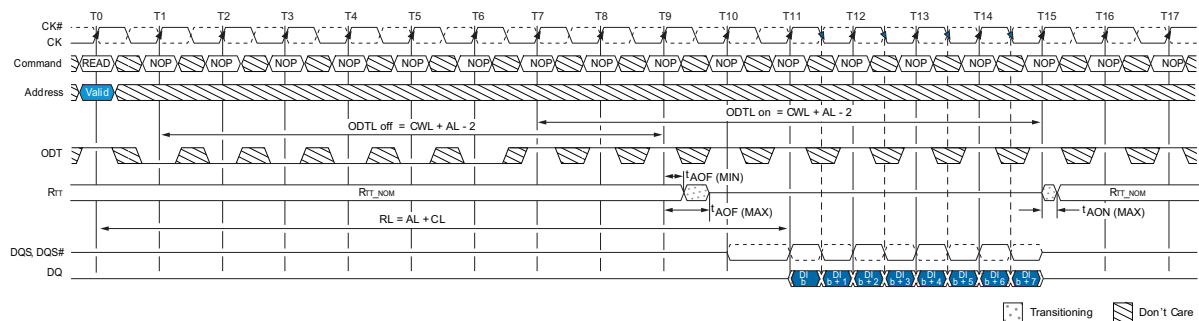


- Notes:
1. WL = 7. Rtt\_NOM is enabled. Rtt\_WR is disabled.
  2. ODT must be held HIGH for at least ODTH4 after assertion (T1).
  3. ODT must be kept HIGH ODTH4 (BC4) or ODTH8 (BL8) after the WRITE command (T7).
  4. ODTH is measured from ODT first registered HIGH to ODT first registered LOW or from the registration of the WRITE command with ODT HIGH to ODT registered LOW.
  5. Although ODTH4 is satisfied from ODT registered HIGH at T6, ODT must not go LOW before T11 as ODTH4 must also be satisfied from the registration of the WRITE command at T7.

**ODT OFF DURING READS**

As the DDR3 SDRAM cannot terminate and drive at the same time, Rtt must be disabled at least one-half clock cycle before the READ preamble by driving the ODT ball LOW. Rtt may not be enabled until the end of the postamble as shown in Figure 108.

**FIGURE 108 - ODT DURING READS**



- Notes:
1. ODT must be disabled externally during READS by driving ODT LOW. For example, CL = 6; AL = CL - 1 = 5; RL = AL + CL = 11; CWL = 5; ODTL on = CWL + AL - 2 = 8; ODTL off = CWL + AL - 2 = 8. Rtt\_NOM is enabled. Rtt\_WR is a "Don't Care."

## 16-32 Gb, DDR3, 256-512M x 32 Dual Channel Memory Module

### ASYNCHRONOUS ODT MODE

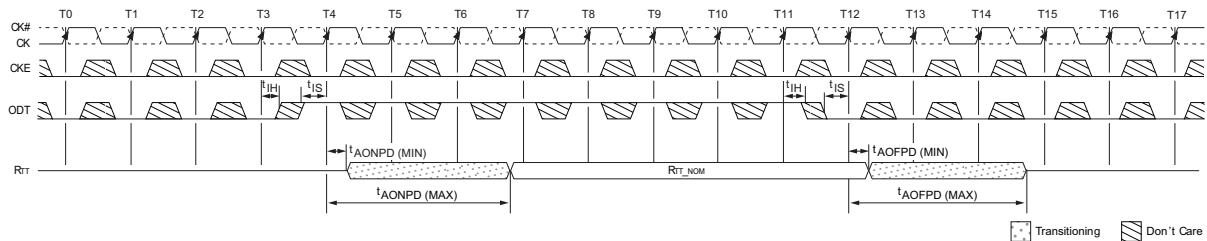
Asynchronous ODT mode is available when the SDRAM runs in DLL ON mode and when either  $R_{TT\_NOM}$  or  $R_{TT\_WR}$  is enabled; however, the DLL is temporarily turned off in PRECHARGED POWER-DOWN standby via  $MR0[12]$ . Additionally, ODT operates asynchronously when the DLL is synchronizing after being RESET. See "POWER-DOWN MODE" for definition and guidance over POWER-DOWN details.

In asynchronous ODT timing mode, the internal ODT command is not delayed by AL relative to the external ODT command. In asynchronous ODT mode, ODT controls  $R_{TT}$  by analog time. The timing parameters  $t_{AONPD}$  and  $t_{AOFPD}$  (see Table 74) replace  $ODTL_{on}/t_{AON}$  and  $ODTL_{off}/t_{AOF}$  respectively, when ODT operates asynchronously (see Figure 109).

The minimum  $R_{TT}$  turn-on time ( $t_{AONPD} [MIN]$ ) is the point at which the device termination circuit leaves HIGH-Z and ODT resistance begins to turn-on. Maximum  $R_{TT}$  turn-on time ( $t_{AONPD} [MAX]$ ) is the point at which ODT resistance is fully on.  $t_{AONPD} [MIN]$  and  $t_{AONPD} [MAX]$  are measured from ODT being sampled HIGH.

The minimum  $R_{TT}$  turn-off time ( $t_{AOFPD} [MIN]$ ) is the point at which the device termination circuit starts to turn off ODT resistance. Maximum  $R_{TT}$  turn-off time ( $t_{AOFPD} [MAX]$ ) is the point at which ODT has reached HIGH-Z.  $t_{AOFPD} [MIN]$  and  $t_{AOFPD} [MAX]$  are measured from ODT being sampled LOW.

**FIGURE 109 - ASYNCHRONOUS ODT TIMING WITH FAST ODT TRANSITION**



Notes: 1. AL is ignored.

**TABLE 74: ASYNCHRONOUS ODT TIMING PARAMETERS FOR ALL SPEED BINS**

Symbol	Description	MIN	MAX	Units
$t_{AONPD}$	Asynchronous $R_{TT}$ TURN-ON delay (POWER-DOWN with DLL off)	2	8.5	ns
$t_{AOFPD}$	Asynchronous $R_{TT}$ TURN-OFF delay (POWER-DOWN with DLL off)	2	8.5	ns



## 16-32 Gb, DDR3, 256-512M x 32 Dual Channel Memory Module

### SYNCHRONOUS TO ASYNCHRONOUS ODT MODE TRANSITION (POWER-DOWN ENTRY)

There is a transition period around POWER-DOWN ENTRY (PDE) where the SDRAM's ODT may exhibit either synchronous or asynchronous behavior. This transition period occurs if the DLL is selected to be off when in PRECHARGE POWER-DOWN mode by the setting of MR0[12] = 0. POWER-DOWN entry begins  $t_{ANPD}$  prior to CKE first being registered LOW and it ends when CLE is first registered LOW.  $t_{ANPD}$  is equal to the greater of  $ODTL\ off + 1^{t}CK$  or  $ODTL\ on + 1^{t}CK$ . If a REFRESH command has been issued, and it is in progress when CKE goes LOW, POWER-DOWN entry will end  $t_{RFC}$  after the REFRESH command rather than when CKE is first registered LOW. POWER-DOWN ENTRY will then become the greater of  $t_{ANPD}$  and  $t_{RFC}$  - REFRESH command to CKE registered LOW.

ODT assertion during POWER-DOWN ENTRY results in an  $R_{TT}$  change as early as the lesser of  $t_{AONPD}$  (MIN) and  $ODTL\ on \times t^{t}CK + t_{AON}$  (MIN) or as late as the greater of  $t_{AONPD}$  (MAX) and  $ODTL\ on \times t^{t}CK + t_{AON}$  (MAX). ODT de-assertion during POWER-DOWN ENTRY may result in an  $R_{TT}$  change as early as the lesser of  $t_{AOFPD}$  (MIN) and  $ODTL\ off \times t^{t}CK + t_{AOF}$  (MIN) or as late as the greater of  $t_{AOFPD}$  (MAX) and  $ODTL\ off \times t^{t}CK + t_{AOF}$  (MAX). Table 75 summarizes these parameters.

If the AL has a large value, the uncertainty of the state of  $R_{TT}$  becomes quite large. This is because  $ODTL\ on$  and  $ODTL\ off$  are derived from the WL and WL is equal to  $CWL + AL$ . Figure 110 shows three different cases;

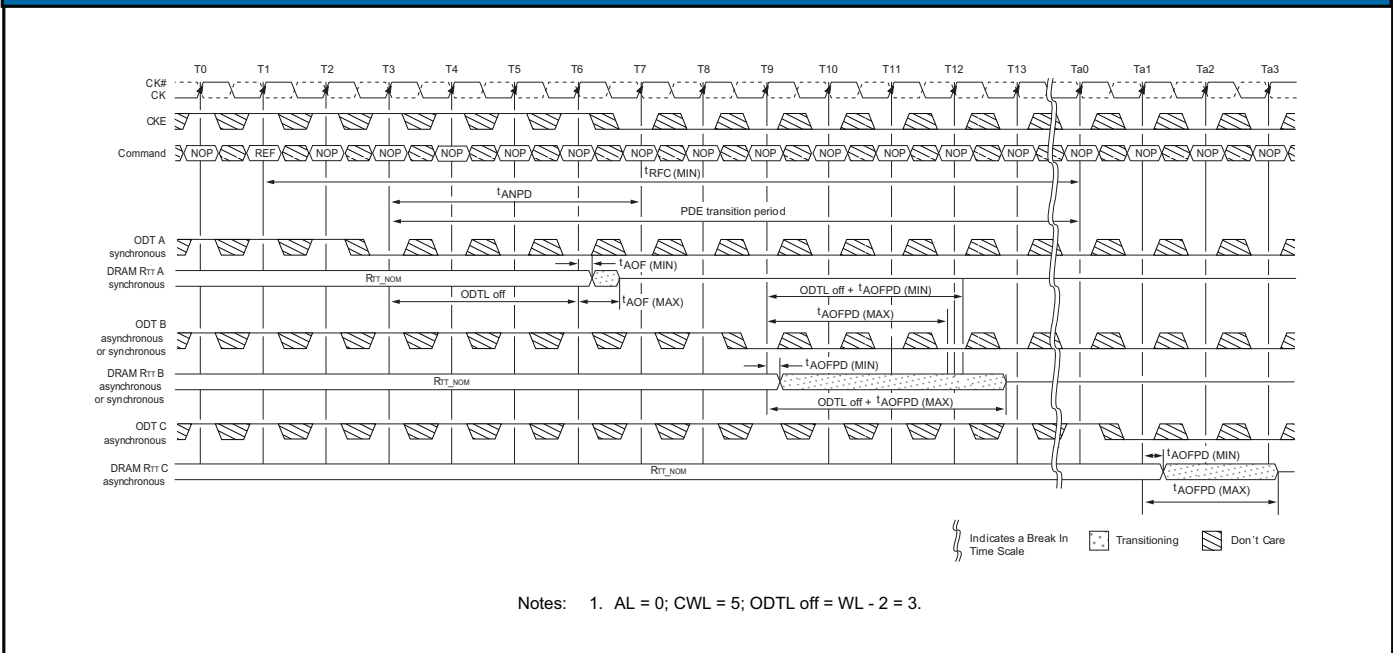
- ODT\_A: Synchronous behavior before  $t_{ANPD}$
- ODT\_B: ODT state changes during the transition period with  $t_{AONPD}$  (MIN) less than  $ODTL\ on \times t^{t}CK + t_{AON}$  (MIN) and  $t_{AONPD}$  (MAX) greater than  $ODTL\ on \times t^{t}CK + t_{AON}$  (MAX)
- ODT\_C: ODT state changes after the transition period with asynchronous behavior

**TABLE 75: ODT PARAMETERS FOR POWER-DOWN (DLL OFF) ENTRY AND EXIT TRANSITION PERIOD**

Description	MIN	MAX
POWER-DOWN entry transition period (POWER-DOWN entry)	Greater of: $t_{ANPD}$ or $t_{RFC}$ - REFRESH to CKE LOW	
POWER-DOWN entry transition (POWER-DOWN exit)	$t_{ANPD} + t_{XPDLL}$	
ODT to $R_{TT}$ TURN-ON delay ( $ODTL\ on = WL - 2$ )	Lesser of: $t_{ANPD}$ (MIN) [1ns] or $ODL\ on \times t^{t}CK + t_{AON}$ (MIN)	Lesser of: $t_{ANPD}$ (MIN) [1ns] or $ODL\ on \times t^{t}CK + t_{AON}$ (MIN)
ODT to $R_{TT}$ TURN-OFF delay ( $ODTL\ off = WL - 2$ )	Lesser of: $t_{AOFPD}$ (MIN) [1ns] or $ODL\ off \times t^{t}CK + t_{AOF}$ (MIN)	Lesser of: $t_{AOFPD}$ (MIN) [1ns] or $ODL\ off \times t^{t}CK + t_{AOF}$ (MIN)
$t_{ANPD}$	$WL - 1$ (Greater of $ODTL\ off + 1$ or $ODTL\ on + 1$ )	

**16-32 Gb, DDR3, 256-512M x 32 Dual Channel Memory Module**

**FIGURE 110 - SYNCHRONOUS TO ASYNCHRONOUS TRANSITION DURING PRECHARGE POWER-DOWN (DLL OFF) ENTRY**



**ASYNCHRONOUS TO SYNCHRONOUS ODT MODE TRANSITION (POWER-DOWN EXIT)**

The SDRAM's ODT may exhibit either asynchronous or synchronous behavior during POWER-DOWN EXIT (PDX). This transition period occurs if the DLL is selected to be off when in PRECHARGE POWER-DOWN mode by setting MR0[12] to "0". POWER-DOWN exit begins  $t_{ANPD}$  prior to CKE first being registered HIGH and it ends  $t_{XPDLL}$  after CKE is first registered HIGH.  $t_{ANPD}$  is equal to the greater of  $ODTL\ off + t^1CK$  or  $ODTL\ on + t^1CK$ . The transition period is  $t_{ANPD}$  plus  $t_{XPDLL}$ .

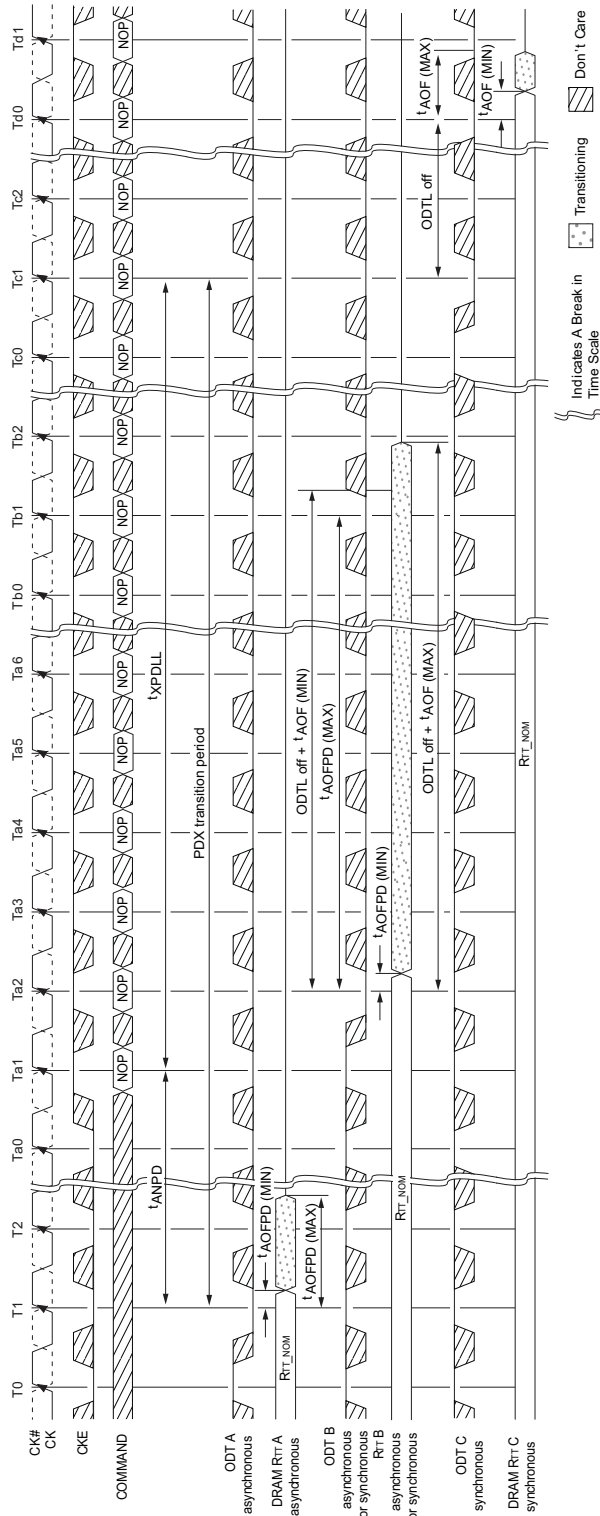
ODT assertion during POWER-DOWN exit results in an  $R_{TT}$  change as early as the lesser of  $t_{AONPD} (MIN)$  and  $ODTL\ on \times t^1CK + t_{AON} (MIN)$  or as late as the greater of  $t_{AONPD} (MAX)$  and  $ODTL\ on \times t^1CK + t_{AON} (MAX)$ . ODT de-assertion during POWER-DOWN EXIT may result in an  $R_{TT}$  change as early as the lesser of  $t_{AOFDP} (MIN)$  and  $ODTL\ off \times t^1CK + t_{AOF} (MIN)$  or as late as the greater of  $t_{AOFDP} (MAX)$  and  $ODTL\ off \times t^1CK + t_{AOF} (MAX)$ . Table 75 summarizes these parameters.

If the AL has a large value, the uncertainty of the  $R_{TT}$  state becomes quite large. This is because  $ODTL\ on$  and  $ODTL\ off$  are derived from the WL, and the WL is equal to  $CWL + AL$ . Figure 111 shows three different cases.

- ODT C: Asynchronous behavior before  $t_{ANPD}$
- ODT B: ODT state changes during the transition period with  $t_{AOFDP} (MIN)$  less than  $ODTL\ off \times t^1CK + t_{AOF} (MIN)$  and  $ODTL\ off \times t^1CK + t_{AOF} (MAX)$  greater than  $t_{AOFDP} (MAX)$
- ODT A: ODT state changes after the transition period with synchronous response

16-32 Gb, DDR3, 256-512M x 32 Dual Channel Memory Module

**FIGURE 111 - ASYNCHRONOUS TO SYNCHRONOUS TRANSITION DURING PRECHARGE POWER-DOWN (DLL OFF) EXIT**



Notes: 1. CL = 6; AL = CL - 1; CWL = 5; ODTL off = WL - 2 = 8.

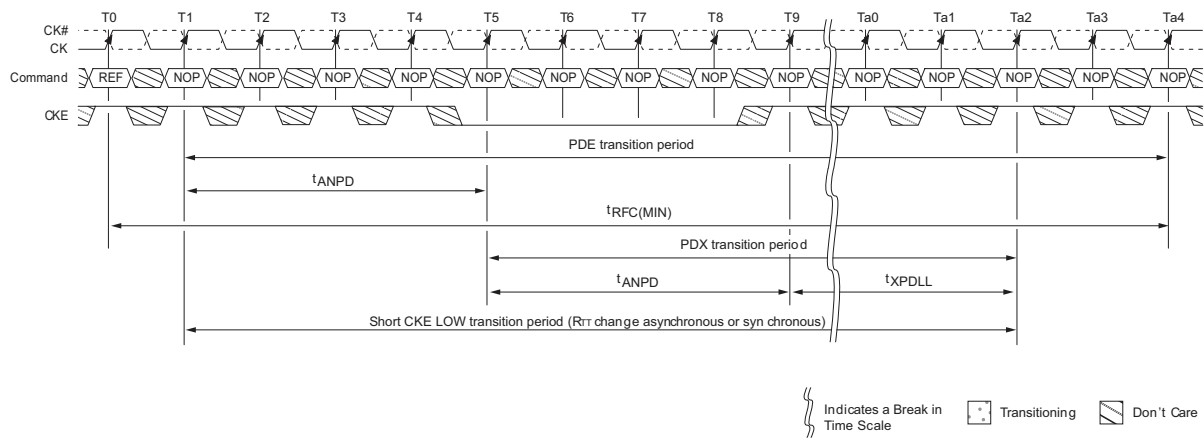
**16-32 Gb, DDR3, 256-512M x 32 Dual Channel Memory Module**

**ASYNCHRONOUS TO SYNCHRONOUS ODT MODE TRANSITION (SHORT CKE PULSE)**

If the time in the PRECHARGE POWER DOWN or IDLE states is very short (short CKE LOW pulses), the POWER-DOWN ENTRY and POWER-DOWN EXIT transition periods will overlap. When overlap occurs, the response of the SDRAM's  $R_{TT}$  to a change in the ODT state may be synchronous or asynchronous from the start of the POWER-DOWN ENTRY transition period to the end of the POWER-DOWN EXIT transition period even if the ENTRY period ends later than the EXIT period. (see Figure 112).

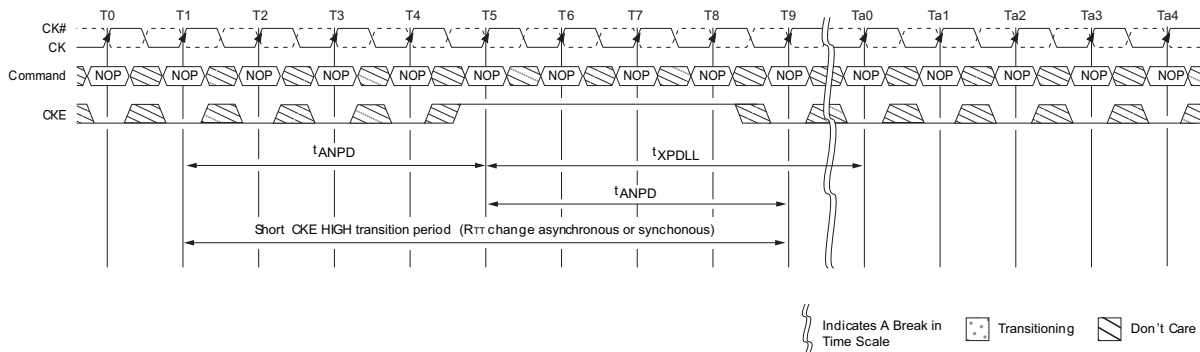
If the time in the idle state is very short (short CKE HIGH pulse), the POWER-DOWN EXIT and POWER-DOWN ENTRY transition periods overlap. When this overlap occurs, the response of the SDRAM's  $R_{TT}$  to a change in the ODT state may be synchronous or asynchronous from the start of the POWER-DOWN EXIT transition period to the end of the POWER-DOWN ENTRY transition period (see Figure 113).

**FIGURE 112 - TRANSITION PERIOD FOR SHORT CKE LOW CYCLES WITH ENTRY AND EXIT PERIOD OVERLAPPING**



Notes: 1. AL = 0, WL = 5,  $t_{ANPD} = 4$ .

**FIGURE 113 - TRANSITION PERIOD FOR SHORT CKE HIGH CYCLES WITH ENTRY AND EXIT PERIOD OVERLAPPING**



Notes: 1. AL = 0, WL = 5,  $t_{ANPD} = 4$ .

## 16-32 Gb, DDR3, 256-512M x 32 Dual Channel Memory Module

### List of Figures

Figure 1: 1Gb DDR3 Part Numbers .....	2
Figure 2: Simplified State Diagram .....	3
Figure 3A: L9D3256M32DBG2 Functional Block Diagram .....	5
Figure 3B: L9D3512M32DBG2 Functional Block Diagram .....	6
Figure 4: Pinout Top View .....	7
Figure 5: Mechanical Drawing .....	13
Figure 6: Input Signal .....	29
Figure 7: Overshoot Specifications .....	30
Figure 8: Undershoot Specifications .....	30
Figure 9: $V_{ix}$ for Differential Signals .....	32
Figure 10: Single-Ended Requirements for Differential Signals .....	32
Figure 11: Definition of Differential AC-Swing and 'DVAC .....	33
Figure 12: Nominal Slew Rate Definition for Single-Ended Input Signals .....	35
Figure 13: Nominal Differential Input Slew Rate Definition for DQS, DQS# and CK, CK# .....	36
Figure 14: ODT Levels and I-V Characteristics .....	37
Figure 15: ODT Timing Reference Load .....	39
Figure 16: 'AON and 'AOF Definitions .....	40
Figure 17: 'AONPD and 'AOFPD Definition .....	41
Figure 18: 'ADC Definition .....	41
Figure 19: Output Driver .....	42
Figure 20: DQ Output Signal .....	47
Figure 21: Differential Output Signal .....	48
Figure 22: Reference Output Load for AC Timing and Output Slew Rate .....	48
Figure 23: Nominal Slew Rate Definition for Single-Ended Output Signals .....	49
Figure 24: Nominal Differential Output Slew Rate Definition for DQS, DQS# .....	50
Figure 25: Nominal Slew Rate and 'VAC for 'IS (Command and Address - Clock) .....	62
Figure 26: Nominal Slew Rate for 'IH (Command and Address - Clock) .....	63
Figure 27: Tangent Line for 'IS (Command and Address - Clock) .....	64
Figure 28: Tangent Line for 'IH (Command and Address - Clock) .....	65
Figure 29: Nominal Slew Rate and 'VAC for 'DS (DQ - Strobe) .....	68
Figure 30: Nominal Slew Rate for 'DH (DQ - Strobe) .....	69
Figure 31: Nominal Slew Rate and 'VAC for 'DS (DQ - Strobe) .....	70
Figure 32: Nominal Slew Rate for 'DH (DQ-Strobe) .....	71
Figure 33: Refresh Mode .....	75
Figure 34: DLL Enable Mode to DLL Disable Mode .....	77
Figure 35: DLL Disable Mode to DLL Enable Mode .....	78
Figure 36: DLL Disable 'DQSCK Timing .....	79
Figure 37: Change Frequency During Precharge Power-Down .....	80
Figure 38: Write Leveling Concept .....	81
Figure 39: Write Leveling Sequence .....	83
Figure 40: Exit Write Leveling .....	84
Figure 41: Initialization Sequence .....	86
Figure 42: MRS-to-MRS Command timing .....	87
Figure 43: MRS-to-nonMRS Command Timing ('MOD) .....	88
Figure 44: Mode Register 0 (MR0) Definitions .....	89
Figure 45: READ Latency .....	91
Figure 46: Mode Register 1 (MR1) Definition .....	92

## 16-32 Gb, DDR3, 256-512M x 32 Dual Channel Memory Module

Figure 47: READ Latency (AL=5, CL=6) .....	94
Figure 48: Mode Register 2 (MR2) Definition .....	92
Figure 49: CAS Write Latency .....	96
Figure 50: Mode Register 3 (MR3) Definition .....	97
Figure 51: Multipurpose Register (MPR) Block Diagram .....	98
Figure 52: MPR System Read Calibration with BL8 - Fixed Burst Order Single Readout .....	101
Figure 53: MPR System Read Calibration with BL8 - Fixed Burst Order, Back-to-Back Readout .....	102
Figure 54: MPR System Read Calibration with BC4 - Lower Nibble, then Upper Nibble .....	103
Figure 55: MPR System Read Calibration with BC4 - Upper Nibble, then Lower Nibble .....	104
Figure 56: ZQ Calibration Timing (ZQCL and ZQCS) .....	106
Figure 57: Example - Meeting 'RRD (MIN) and 'RCD (MIN) .....	107
Figure 58: Example - 'FAW .....	107
Figure 59: READ Latency .....	108
Figure 60: Consecutive READ Bursts (BL8) .....	109
Figure 61: Consecutive READ Bursts (BC4) .....	110
Figure 62: Nonconsecutive READ Bursts .....	111
Figure 63: READ (BL8) to WRITE (BL8) .....	112
Figure 64: READ (BC4) to WRITE (BC4) OTF .....	113
Figure 65: READ to PRECHARGE (BL8) .....	114
Figure 66: READ to PRECHARGE (BC4) .....	115
Figure 67: READ to PRECHARGE (AL=5, CL=6) .....	116
Figure 68: READ with Auto Precharge (AL=4, CL=6) .....	117
Figure 69: Data Output Timing - 'DQSQ and Data Valid Window .....	119
Figure 70: Data Strobe Timing - READs .....	121
Figure 71: Method for Calculating 'LZ and 'HZ .....	122
Figure 72: 'RPRE Timing .....	123
Figure 73: 'RPST Timing .....	123
Figure 74: 'WPRE Timing .....	124
Figure 75: 'WPST Timing .....	124
Figure 76: Write Burst .....	126
Figure 77: Consecutive WRITE (BL8) to WRITE (BL8) .....	127
Figure 78: Consecutive WRITE (BC4) to WRITE (BC4) via MRS or OTF .....	127
Figure 79: Nonconsecutive WRITE to WRITE .....	128
Figure 80: WRITE (BL8) to READ (BL8) .....	128
Figure 81: WRITE to READ (BC4 Mode Register Setting) .....	129
Figure 82: WRITE (BC4 OTF) to READ (BC4 OTF) .....	130
Figure 83: WRITE (BL8) to PRECHARGE .....	131
Figure 84: WRITE (BC4 Mode Register Setting) to PRECHARGE .....	131
Figure 85: WRITE (BC4 OTF) to PRECHARGE .....	132
Figure 86: Data Input Timing .....	132
Figure 87: Self Refresh Entry/Exit Timing .....	134
Figure 88: Active Power-Down Entry and Exit .....	137
Figure 89: Precharge Power-Down (Fast-Exit Mode) Entry and Exit .....	137
Figure 90: Precharge Power-Down (Slow-Exit Mode) Entry and Exit .....	138
Figure 91: Power-Down Entry After READ or READ with Auto Precharge (RDAP) .....	138
Figure 92: Power-Down Entry After WRITE .....	139
Figure 93: Power-Down Entry After WRITE with Auto Precharge (WRAP) .....	139
Figure 94: REFRESH to Power-Down Entry .....	140
Figure 95: ACTIVATE to Power-Down Entry .....	140
Figure 96: PRECHARGE to Power-Down Entry .....	141

## 16-32 Gb, DDR3, 256-512M x 32 Dual Channel Memory Module

Figure 97: MRS Command to Power-Down Entry .....	141
Figure 98: Power-Down Exit to Refresh to Power-Down Entry .....	142
Figure 99: RESET Sequence .....	143
Figure 100: On-Die Termination .....	144
Figure 101: Dynamic ODT - ODT Asserted Before and After the WRITE, BC4 .....	147
Figure 102: Dynamic ODT - Without WRITE Command .....	147
Figure 103: Dynamic ODT - ODT Pin Asserted Together with WRITE Command for 6 Clock Cycles, BL8 .....	148
Figure 104: Dynamic ODT - ODT Pin Asserted with WRITE Command for 6 Clock Cycles, BC4 .....	148
Figure 105: Dynamic ODT - ODT Pin Asserted with WRITE Command for 4 Clock Cycles, BC4 .....	149
Figure 106: Synchronous ODT .....	150
Figure 107: Synchronous ODT (BC4) .....	151
Figure 108: ODT During READs .....	151
Figure 109: Asynchronous ODT Timing with Fast ODT Transition .....	152
Figure 110: Synchronous to Asynchronous Transition during Precharge Power-Down (DLL Off) Entry .....	154
Figure 111: Asynchronous to Synchronous Transition during Precharge Power-Down (DLL Off) Exit .....	155
Figure 112: Transition Period for Short CKE LOW Cycles with Entry and Exit Period Overlapping .....	156
Figure 113: Transition Period for Short CKE HIGH Cycles with Entry and Exit Period Overlapping .....	156

## 16-32 Gb, DDR3, 256-512M x 32 Dual Channel Memory Module

### List of Tables

Table 1: Addressing .....	2
Table 2: Ball/Signal Location and Description .....	8
Table 3: Absolute Maximum Ratings .....	14
Table 4: Input/Output Capacitance .....	14
Table 5: Timing Parameters for IDD Measurements - Clock Units .....	15
Table 6: I <sub>DD0</sub> Measurement Loop .....	16
Table 7: I <sub>DD1</sub> Measurement Loop .....	17
Table 8: I <sub>DD</sub> Measurement Conditions for Power-Down Currents .....	18
Table 9: I <sub>DD2N</sub> /I <sub>DD3N</sub> Measurement Loop .....	19
Table 10: I <sub>DD2NT</sub> Measurement Loop .....	20
Table 11: I <sub>DD4R</sub> Measurement Loop .....	21
Table 12: I <sub>DD4W</sub> Measurement Loop .....	22
Table 13: I <sub>DD5B</sub> Measurement Loop .....	23
Table 14: I <sub>DD</sub> Measurement Loop .....	24
Table 15: I <sub>DD7</sub> Measurement Loop .....	25
Table 16: I <sub>DD</sub> Maximum Limits .....	26
Table 17: DC Electrical Characteristics and Operating Conditions .....	27
Table 18: DC Electrical Characteristics and Input Conditions .....	27
Table 19: Input Switching Conditions .....	28
Table 20: Control and Address Pins .....	30
Table 21: Clock, Data, Strobe, and Mask Pins .....	30
Table 22: Differential Input Operating Conditions (CKx, CKx\, DQSx, and DQSx\)	31
Table 23: Differential Input Operating conditions ('DVAC) for CKx, CKx\, DQSx, and DQSx\)	33
Table 24: Single-Ended Input Slew Rate .....	34
Table 25: Differential Input Slew Rate Definition .....	36
Table 26: On-Die Termination DC Electrical Characteristics .....	37
Table 27: R <sub>TT</sub> Effective Impedances .....	38
Table 28: ODT Sensitivity Definition .....	39
Table 29: ODT Temperature & Voltage Sensitivity .....	39
Table 30: ODT Timing Definitions .....	40
Table 31: Reference Settings for ODT Timing Measurements .....	40
Table 32: 34Ω Driver Impedance Characteristics .....	42
Table 33: 34Ω Driver Pull-Up and Pull-Down Impedance Calculations .....	43
Table 34: 34Ω Driver I <sub>OH</sub> /I <sub>OL</sub> Characteristics - V <sub>DD</sub> = V <sub>DDQ</sub> = 1.35V .....	43
Table 35: 34Ω Driver I <sub>OH</sub> /I <sub>OL</sub> Characteristics - V <sub>DD</sub> = V <sub>DDQ</sub> = 1.4175V .....	43
Table 36: 34Ω Driver I <sub>OH</sub> /I <sub>OL</sub> Characteristics - V <sub>DD</sub> = V <sub>DDQ</sub> = 1.2825V .....	44
Table 37: 34Ω Output Driver Sensitivity Definition .....	44
Table 38: 34Ω Output Driver Voltage and Temperature Sensitivity .....	44
Table 39: 40Ω Driver Impedance Characteristics .....	45
Table 40: 40Ω Output Driver Sensitivity Definition .....	45
Table 41: 40Ω Output Driver Voltage and Temperature Sensitivity .....	46
Table 42: Single-Ended Output Driver Characteristics .....	46
Table 43: Differential Output Driver Characteristics .....	47
Table 44: Single-Ended Output Slew Rate .....	49
Table 45: Differential Output Slew Rate Definition .....	50
Table 46: Speed Bins .....	51
Table 47: Electrical Characteristics and AC Operating Conditions .....	52
Table 48: Command and Address Setup and Hold Values Referenced at 1V/ns - AC/DC Based .....	60



## 16-32 Gb, DDR3, 256-512M x 32 Dual Channel Memory Module

Table 49: Derating Values for tIS/tIH - AC175/DC100-Based .....	60
Table 50: Derating Values for tIS/tIH - AC150/DC100-Based .....	61
Table 51: Minimum Required Time $t_{VAC}$ above $V_{IH(AC)}$ for a Valid Transition .....	61
Table 52: Data Setup and Hold Values at 1V/ns (DQSx, DQSx\ at 2V/ns) - AC/DC Based .....	66
Table 53: Derating Value for tDS/tDH - AC175/DC100 - Based .....	66
Table 54: Derating Value for tDS/tDH - AC150/DC100 - Based .....	67
Table 55: Required Time $t_{VAC}$ above $V_{IH(AC)}$ (Below $V_{IL(AC)}$ ) for a Valid Transition .....	67
Table 56: Truth Table - Command .....	72
Table 57: Truth Table - CKE .....	73
Table 58: Read Command Summary .....	74
Table 59: Write Command Summary .....	74
Table 60: Burst Order .....	90
Table 61: Burst Order .....	99
Table 62: Burst Order .....	100
Table 63: SELF REFRESH Temperature and AUTO SELF REFRESH Description .....	135
Table 64: SELF REFRESH Mode Summary .....	135
Table 65: COMMAND to POWER-DOWN Entry Parameters .....	136
Table 66: POWER-DOWN Modes .....	136
Table 67: POWER-DOWN Modes .....	144
Table 68: ODT Parameter .....	145
Table 69: DYNAMIC ODT Specific Parameters .....	146
Table 70: MODE REGISTERS for $R_{TT\_NOM}$ .....	146
Table 71: MODE REGISTERS for $R_{TT\_WR}$ .....	146
Table 72: TIMING DIAGRAMS for DYNAMIC ODT .....	146
Table 73: SYNCHRONOUS ODT Parameters .....	150
Table 74: ASYNCHRONOUS ODT Timing Parameters for all Speed Bins .....	152
Table 75: ODT Parameters for POWER-DOWN (DLL Off) Entry and Exit Transition Period .....	153

## 16-32 Gb, DDR3, 256-512M x 32 Dual Channel Memory Module

REVISION HISTORY			
Revision	Engineer	Issue Date	Description Of Change
A	KHL	01.31.2012	INITIATE
B	KHL	03.21.2012	Corrected the Industrial operating temperature range in Table 3 (Absolute Maximum Ratings)
C	KHL	06.12.2012	Part Number Change. Updated Block and Pinout Diagrams. Added List of Tables and Figures
D	KHL	03.06.2013	Updated Block and Pinout Diagrams

LOGIC Devices Incorporated reserves the right to make corrections, modifications, enhancements, improvements, and other changes to its products and services at any time and to discontinue any product or service without notice. Customers should obtain the latest relevant information before placing orders and should verify that such information is current and complete. LOGIC Devices does not assume any liability arising out of the application or use of any product or circuit described herein. In no event shall any liability exceed the product purchase price. LOGIC Devices believes the information contained herein is accurate, however it is not liable for inadvertent errors. Information subject to change without notice. LOGIC Devices assumes no liability for use of its products in mission critical or life support applications. Products of LOGIC Devices are not warranted nor intended to be used for medical, life support, life saving, critical control or safety applications, unless pursuant to an express written agreement with LOGIC Devices. Furthermore, LOGIC Devices does not authorize its products for use as critical components in life-support systems where a malfunction or failure may reasonably be expected to result in significant injury to the user.