

### 1. PART NO. EXPRESSION :

P I C 0 4 0 1 H 1 0 0 M F - □ □

(a) (b) (c) (d) (e)(f) (g)

(a) Series code

(b) Dimension code

(c) Type code

(d) Inductance code : 100 = 10.0uH

(e) Tolerance code : M = ±20%, Y = ±30%

(f) F : RoHS Compliant

(g) 11~99 : Internal controlled number

### 2. CONFIGURATION & DIMENSIONS :

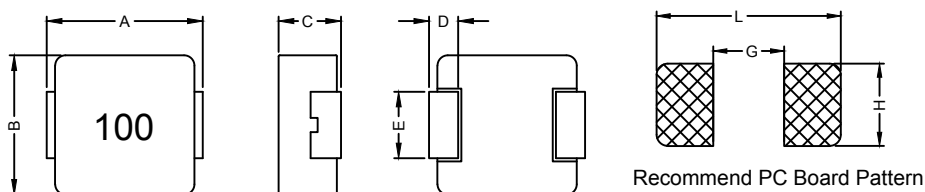

Unit:m/m

A	B	C	D	E	G	H	L
4.45±0.25	4.06±0.25	0.8±0.2	0.76±0.30	1.5±0.20	2.2	1.8	5.2

### 3. SCHEMATIC :



### 4. MATERIALS :

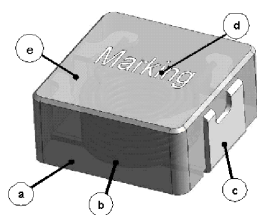

(a) Core

(b) Wire

(c) Terminal

(d) Ink

(e) Paint



**RoHS Compliant**

NOTE : Specifications subject to change without notice. Please check our website for latest information.

09.11.2015



**SUPERWORLD ELECTRONICS (S) PTE LTD**

PG. 1

### 5. GENERAL SPECIFICATION :

- a) Test Freq. : L : 100KHz/1.0V
- b) Operating Temp. : -40°C to +125°C
- c) Storage Temp. : -40°C to +125°C
- d) Humidity Range : 85 ± 3% RH
- e) Heat Rated Current (Irms) will cause the coil temperature rise approximately  $\Delta t$  of 40°C (keep 1min)
- f) Saturation Current (Isat) will cause L0 to drop 30%.
- g) Part Temperature (Ambient+Temp. Rise) : Should not exceed 125°C under worst case operating conditions.
- h) Storage condition (component in its packaging)
  - i) Temperature: -10 to 40°C
  - ii) Humidity : 50~60% RH

### 6. ELECTRICAL CHARACTERISTICS :

Part No.	Inductance L <sub>0</sub> ( $\mu$ H) @ 0 A	Irms ( A ) Typ.	Isat ( A ) Typ.	DCR ( m $\Omega$ ) Typ. @ 25°C	DCR ( m $\Omega$ ) Max. @ 25°C
PIC0401H1R0MF	1.0	3.6	5.5	50	58
PIC0401H1R2MF	1.2	3.4	5.0	53	62
PIC0401H1R5MF	1.5	2.6	3.7	67	78
PIC0401H2R2MF	2.2	2.3	3.4	95	112
PIC0401H3R3MF	3.3	2.1	2.8	156	188
PIC0401H4R7MF	4.7	1.7	2.2	262	315
PIC0401H5R6MF	5.6	1.5	2.0	306	368
PIC0401H6R8MF	6.8	1.3	1.7	386	463
PIC0401H8R2MF	8.2	1.2	1.6	500	585
PIC0401H100MF	10.0	1.1	1.4	550	650

Tolerance code : M =  $\pm$ 20%, Y =  $\pm$ 30%



**RoHS Compliant**

NOTE : Specifications subject to change without notice. Please check our website for latest information.

09.11.2015



**SUPERWORLD ELECTRONICS (S) PTE LTD**

### 7. CHARACTERISTICS CURVES :

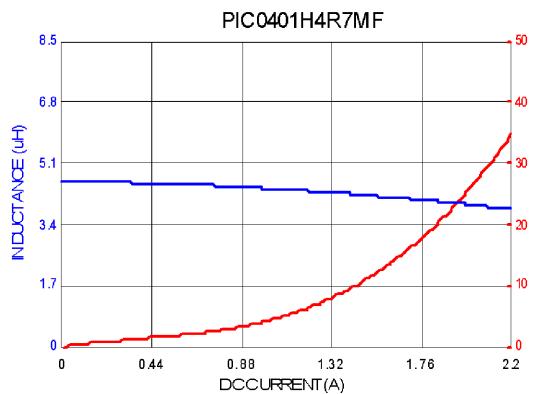
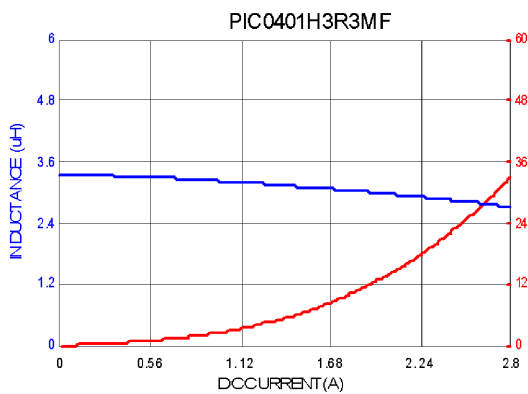
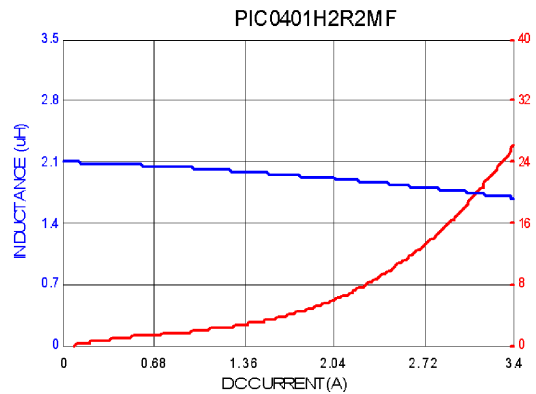
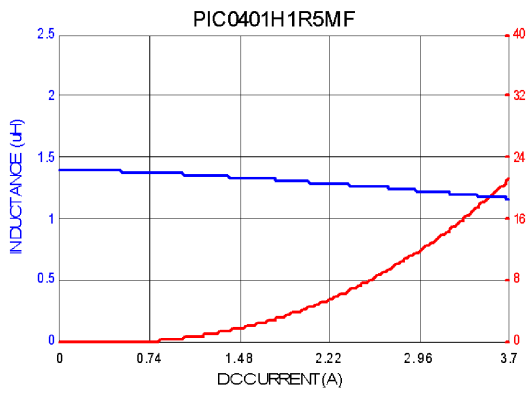
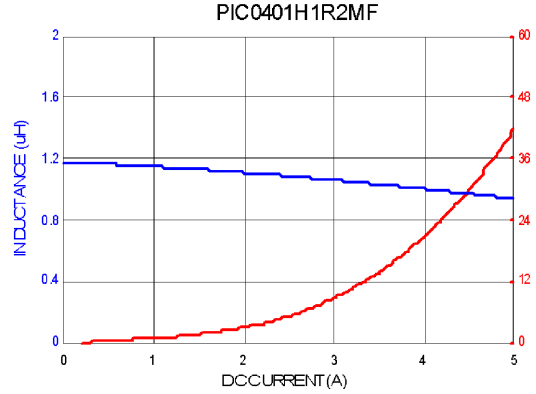
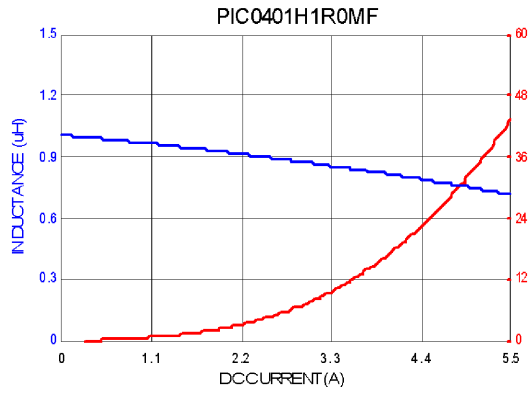

**RoHS Compliant**

NOTE : Specifications subject to change without notice. Please check our website for latest information.

09.11.2015



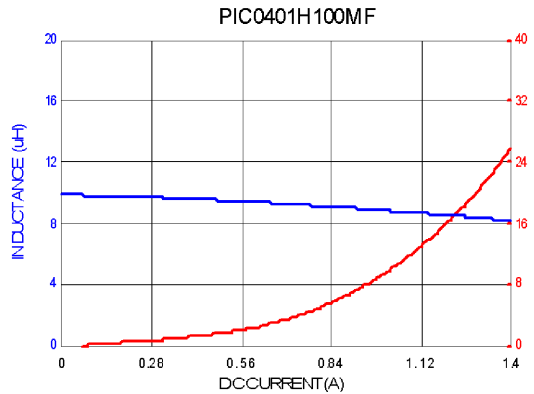
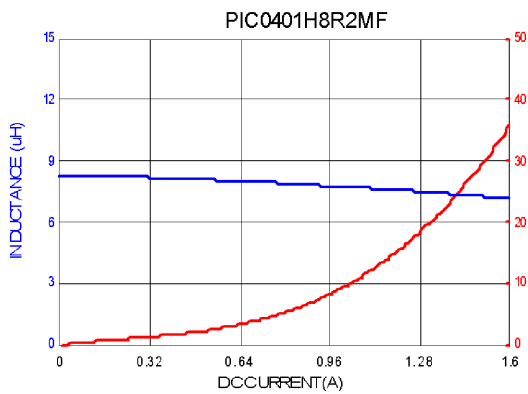
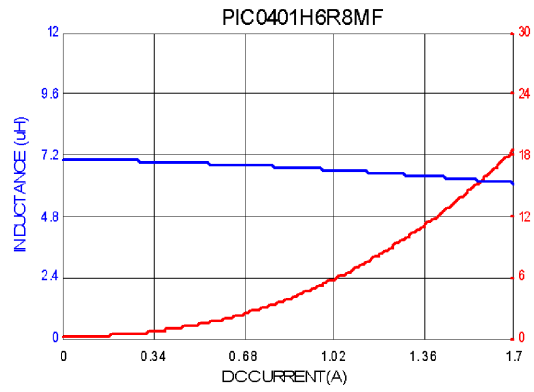
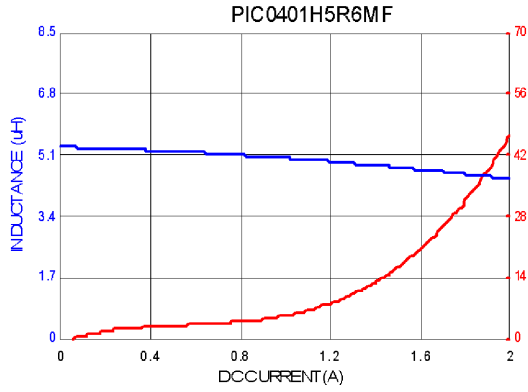

**RoHS Compliant**

NOTE : Specifications subject to change without notice. Please check our website for latest information.

09.11.2015



**SUPERWORLD ELECTRONICS (S) PTE LTD**

## 8. SOLDERING

Mildly activated rosin fluxes are preferred. The minimum amount of solder can lead to damage from the stresses caused by the difference in coefficients of expansion between solder, chip and substrate. Our terminations are suitable for all re-flow soldering systems. If hand soldering cannot be avoided, the preferred technique is the utilization of hot air soldering tools.

### 8-1.1 Solder Re-flow :

Recommended temperature profiles for re-flow soldering in Figure 1.

### 8-1.2 Soldering Iron (Figure 2) :

Products attachment with soldering iron is discouraged due to the inherent process control limitations. In the event that a soldering iron must be employed the following precautions are recommended.

Note :

- a) Preheat circuit and products to 150°C.
- b) 355°C tip temperature (max)
- c) Never contact the ceramic with the iron tip
- d) 1.0mm tip diameter (max)
- e) Use a 20 watt soldering iron with tip diameter of 1.0mm
- f) Limit soldering time to 4~5 secs.

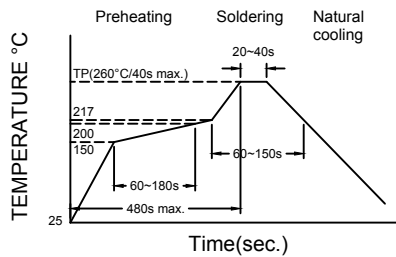

Figure 1. Re-flow Soldering: 3 times max.

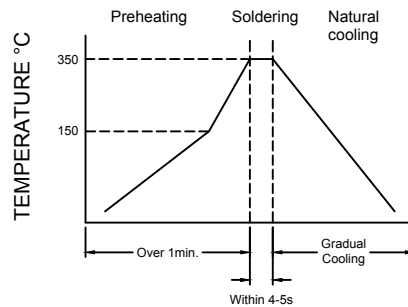

Figure 2. Hand Soldering: 1 times max.



**RoHS Compliant**

NOTE : Specifications subject to change without notice. Please check our website for latest information.



### 9. PACKAGING INFORMATION :

#### 9-1. Reel Dimension

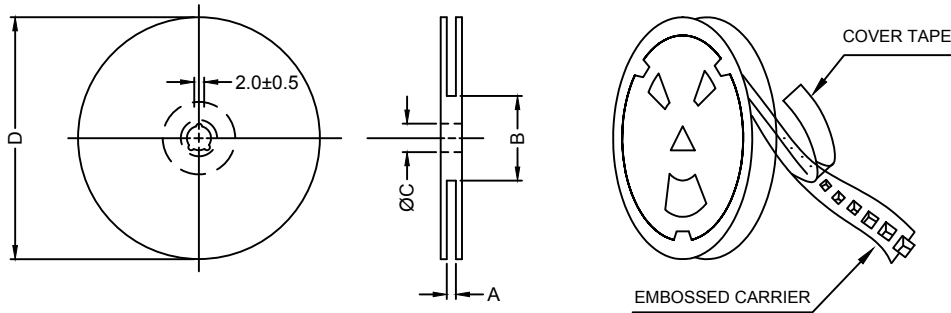

Type	A(mm)	B(mm)	C(mm)	D(mm)
13" x 12mm	12.4+2.0/-0	100±2.0	13.5±0.5	330

#### 9-2 Tape Dimension

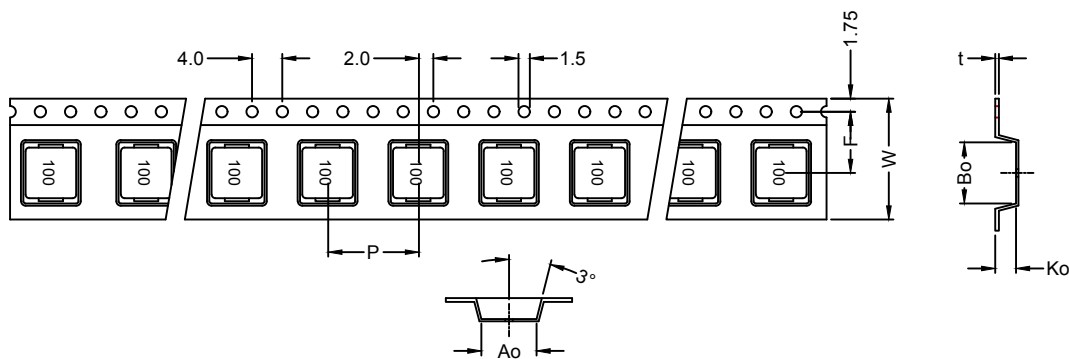

Series	Ao(mm)	Bo(mm)	Ko(mm)	P(mm)	W(mm)	F(mm)	t(mm)
PIC0401	4.40±0.1	5.0±0.1	1.1±0.1	8.0±0.1	12.0±0.3	7.5±0.1	0.35±0.05

#### 9-3. Packaging Quantity

Size	PIC0401
Chip / Reel	5000
Inner Box	10000
Carton	40000



**RoHS Compliant**

NOTE : Specifications subject to change without notice. Please check our website for latest information.

09.11.2015



**SUPERWORLD ELECTRONICS (S) PTE LTD**

### 9-4. Tearing Off Force

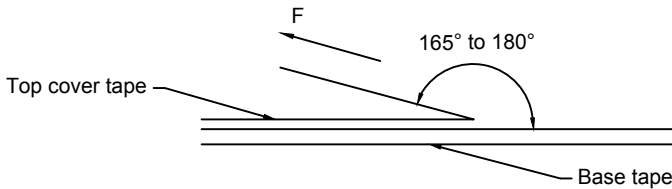

The force for tearing off cover tape is 10 to 130 grams in the arrow direction under the following conditions. (referenced ANSI/EIA-481-C-2003 of 4.11 standard)

Room Temp. (°C)	Room Humidity (%)	Room atm (hPa)	Tearing Speed (mm/min)
5~35	45~85	860~1060	300

### Application Notice

#### 1. Storage Conditions :

To maintain the solderability of terminal electrodes :

- a) Recommended products should be used within 12 months from the time of delivery.
- b) The packaging material should be kept where no chlorine or sulfur exists in the air.

#### 2. Transportation :

- a) Products should be handled with care to avoid damage or contamination from perspiration and skin oils.
- b) Vacuum pick up is strongly recommended for individual components.
- c) Bulk handling should ensure that abrasion and mechanical shock are minimized.



**RoHS Compliant**

NOTE : Specifications subject to change without notice. Please check our website for latest information.

09.11.2015



**SUPERWORLD ELECTRONICS (S) PTE LTD**