

Single IGBTMOD™ H-Series Module 300 Amperes/1400 Volts

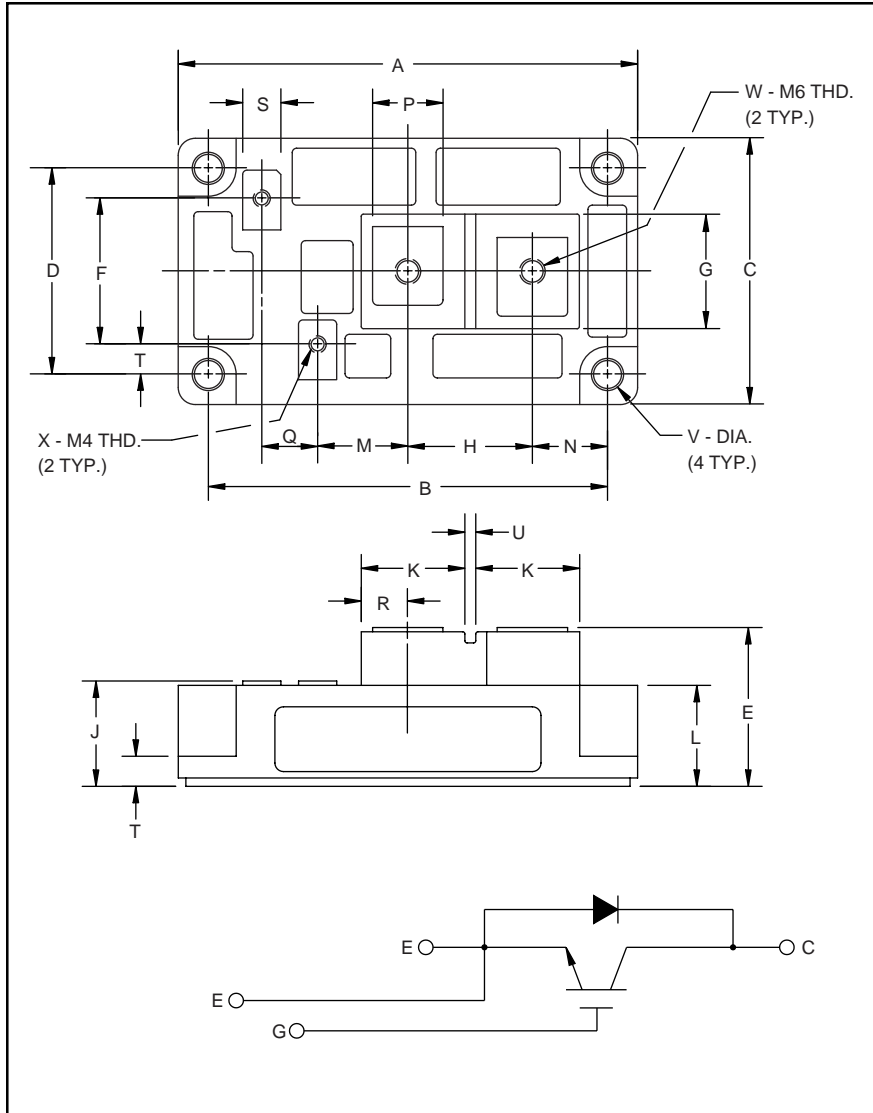

Outline Drawing and Circuit Diagram

Dimensions	Inches	Millimeters
A	4.21	107.0
B	3.661±0.01	93.0±0.25
C	2.44	62.0
D	1.89±0.01	48.0±0.25
E	1.42 Max.	36.0 Max.
F	1.34	34.0
G	1.18	30.0
H	1.14	29.0
J	0.98 Max.	25.0 Max.
K	0.94	24.0
L	0.93	23.5

Dimensions	Inches	Millimeters
M	0.83	21.0
N	0.69	17.5
P	0.63	16.0
Q	0.51	13.0
R	0.43	11.0
S	0.35	9.0
T	0.28	7.0
U	0.12	3.0
V	0.26 Dia.	Dia. 6.5
W	M6 Metric	M6
X	M4 Metric	M4



Description:

Powerex IGBTMOD™ Modules are designed for use in switching applications. Each module consists of one IGBT Transistor in a single configuration with a reverse-connected super-fast recovery free-wheel diode. All components and interconnects are isolated from the heat sinking baseplate, offering simplified system assembly and thermal management.

Features:

- Low Drive Power
- Low $V_{CE(sat)}$
- Discrete Super-Fast Recovery (135ns) Free-Wheel Diode
- High Frequency Operation (20-25kHz)
- Isolated Baseplate for Easy Heat Sinking

Applications:

- AC Motor Control
- Motion/Servo Control
- UPS
- Welding Power Supplies
- Laser Power Supplies

Ordering Information:

Example: Select the complete part module number you desire from the table below -i.e. CM300HA-28H is a 1400V (V_{CES}), 300 Ampere Single IGBTMOD™ Power Module.

Type	Current Rating Amperes	V_{CES} Volts (x 50)
CM	300	28

CM300HA-28H
Single IGBTMOD™ H-Series Module
 300 Amperes/1400 Volts

Absolute Maximum Ratings, $T_j = 25\text{ }^\circ\text{C}$ unless otherwise specified

Ratings	Symbol	CM300HA-28H	Units
Junction Temperature	T_j	-40 to 150	$^\circ\text{C}$
Storage Temperature	T_{stg}	-40 to 125	$^\circ\text{C}$
Collector-Emitter Voltage (G-E SHORT)	V_{CES}	1400	Volts
Gate-Emitter Voltage (C-E SHORT)	V_{GES}	± 20	Volts
Collector Current ($T_c = 25^\circ\text{C}$)	I_C	300	Amperes
Peak Collector Current ($T_j \leq 150^\circ\text{C}$)	I_{CM}	600	Amperes
Emitter Current* ($T_c = 25^\circ\text{C}$)	I_E	300	Amperes
Peak Emitter Current* ($T_j \leq 150^\circ\text{C}$)	I_{EM}	600	Amperes
Maximum Collector Dissipation ($T_c = 25^\circ\text{C}$)	P_c	2100	Watts
Max. Mounting Torque M6 Main Terminal Screws	-	26	in-lb
Max. Mounting Torque M6 Mounting Screws	-	26	in-lb
Max. Mounting Torque M4 Terminal Screws	-	13	in-lb
Module Weight (Typical)	-	400	Grams
V Isolation (Main Terminal to Baseplate, AC 1 min.)	V_{RMS}	2500	Volts

Static Electrical Characteristics, $T_j = 25\text{ }^\circ\text{C}$ unless otherwise specified

Characteristics	Symbol	Test Conditions	Min.	Typ.	Max.	Units
Collector-Cutoff Current	I_{CES}	$V_{CE} = V_{CES}, V_{GE} = 0V$	-	-	1.0	mA
Gate Leakage Current	I_{GES}	$V_{GE} = V_{CES}, V_{CE} = 0V$	-	-	0.5	μA
Gate-Emitter Threshold Voltage	$V_{GE(th)}$	$I_C = 30\text{mA}, V_{CE} = 10V$	5.0	6.5	8.0	Volts
Collector-Emitter Saturation Voltage	$V_{CE(sat)}$	$I_C = 300\text{A}, V_{GE} = 15V, T_j = 25^\circ\text{C}$	-	3.1	4.2	Volts
		$I_C = 300\text{A}, V_{GE} = 15V, T_j = 125^\circ\text{C}$	-	2.95	-	Volts
Total Gate Charge	Q_G	$V_{CC} = 800V, I_C = 300\text{A}, V_{GE} = 15V$	-	1530	-	nC
Emitter-Collector Voltage*	V_{EC}	$I_E = 300\text{A}, V_{GE} = 0V$	-	-	3.8	Volts

Dynamic Electrical Characteristics, $T_j = 25\text{ }^\circ\text{C}$ unless otherwise specified

Characteristics	Symbol	Test Conditions	Min.	Typ.	Max.	Units
Input Capacitance	C_{ies}		-	-	60	nF
Output Capacitance	C_{oes}	$V_{GE} = 0V, V_{CE} = 10V, f = 1\text{MHz}$	-	-	21	nF
Reverse Transfer Capacitance	C_{res}		-	-	12	nF
Resistive	Turn-on Delay Time	$t_{d(on)}$	-	-	250	ns
Load	Rise Time	t_r	-	-	500	ns
Switching	Turn-off Delay Time	$t_{d(off)}$	-	-	350	ns
Times	Fall Time	t_f	-	-	500	ns
Diode Reverse Recovery Time*	t_{rr}	$I_E = 300\text{A}, di_E/dt = -600\text{A}/\mu\text{s}$	-	-	300	ns
Diode Reverse Recovery Charge*	Q_{rr}	$I_E = 300\text{A}, di_E/dt = -600\text{A}/\mu\text{s}$	-	3.0	-	μC

Thermal and Mechanical Characteristics, $T_j = 25\text{ }^\circ\text{C}$ unless otherwise specified

Characteristics	Symbol	Test Conditions	Min.	Typ.	Max.	Units
Thermal Resistance, Junction to Case	$R_{th(j-c)}$	Per IGBT	-	-	0.06	$^\circ\text{C}/\text{W}$
Thermal Resistance, Junction to Case	$R_{th(j-c)}$	Per FWDi	-	-	0.12	$^\circ\text{C}/\text{W}$
Contact Thermal Resistance	$R_{th(c-f)}$	Per Module, Thermal Grease Applied	-	-	0.04	$^\circ\text{C}/\text{W}$

* Represents characteristics of the anti-parallel, emitter-to-collector free-wheel diode.



Powerex, Inc., 200 Hillis Street, Youngwood, Pennsylvania 15697-1800 (724) 925-7272

CM300HA-28H
Single IGBTMOD™ H-Series Module
 300 Amperes/1400 Volts

OUTPUT CHARACTERISTICS (TYPICAL)

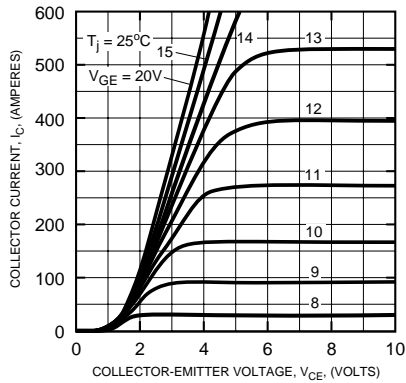

TRANSFER CHARACTERISTICS (TYPICAL)

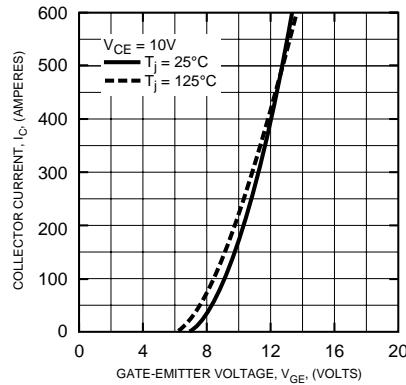

COLLECTOR-EMITTER SATURATION VOLTAGE CHARACTERISTICS (TYPICAL)

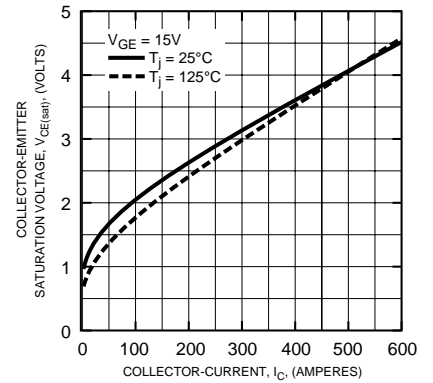

COLLECTOR-EMITTER SATURATION VOLTAGE CHARACTERISTICS (TYPICAL)

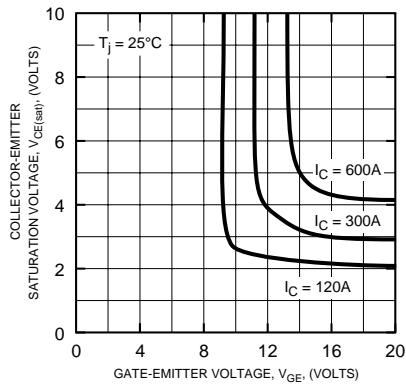

FREE-WHEEL DIODE FORWARD CHARACTERISTICS (TYPICAL)

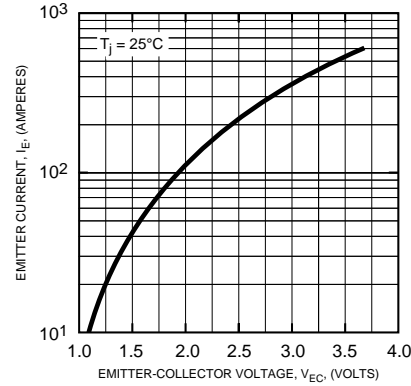

CAPACITANCE VS. VCE (TYPICAL)

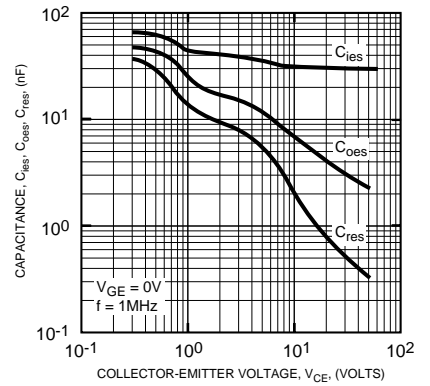

HALF-BRIDGE SWITCHING CHARACTERISTICS (TYPICAL)

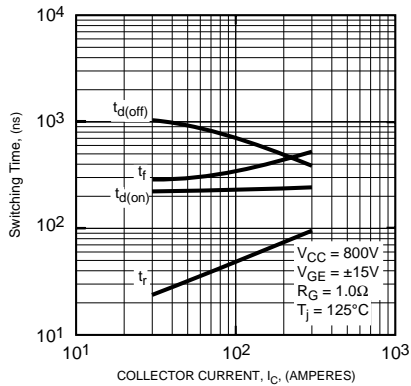

REVERSE RECOVERY CHARACTERISTICS (TYPICAL)

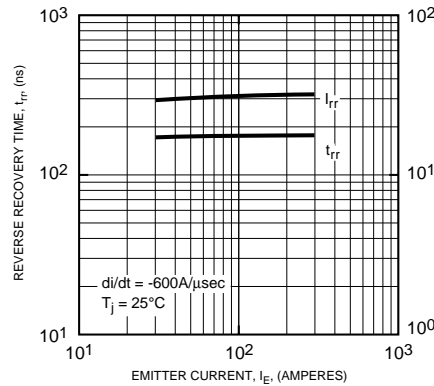

GATE CHARGE, VGE

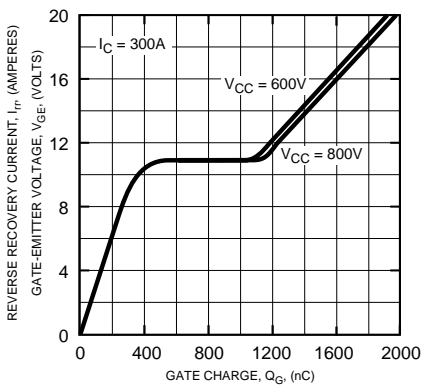

CM300HA-28H
Single IGBTMOD™ H-Series Module
 300 Amperes/1400 Volts

