

PE42512

Document Category: Product Specification

UltraCMOS® SP12T RF Switch, 9 kHz–8 GHz



Features

- High isolation: 39 dB @ 6 GHz
- Low insertion loss: 1.3 dB @ 6 GHz
- Fast switching time of 232 ns
- Power handling of 33 dBm CW
- Logic select (LS) pin provides maximum control logic flexibility
- Terminated all-off state mode
- External V_{SS} pin to eliminate spur
- Packaging – 32-lead 5 × 5 × 0.85 mm QFN

Applications

- Test and measurement
- Wireless applications up to 8 GHz
- Filter bank switching
- RF signal routing

Figure 1 • PE42512 Functional Diagram

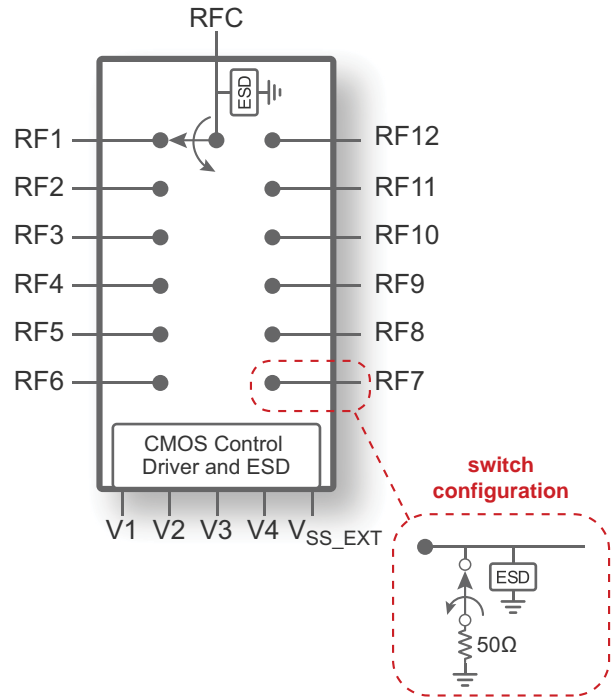

Product Description

The PE42512 is a HaRP™ technology-enhanced absorptive SP12T RF switch that supports a frequency range from 9 kHz to 8 GHz. An external V_{SS} pin is available for bypassing the internal negative voltage generator in order for the PE42512 to deliver spur-free performance. It delivers high isolation, low insertion loss, and fast switching time, making this device ideal for filter bank switching and RF signal routing in test and measurement (T&M) and wireless applications up to 8 GHz. No blocking capacitors are required if DC voltage is not present on the RF ports.

The PE42512 is manufactured on Peregrine’s UltraCMOS® process, a patented advanced form of silicon-on-insulator (SOI) technology.

Peregrine’s HaRP technology enhancements deliver high linearity and excellent harmonics performance. It is an innovative feature of the UltraCMOS process, offering the performance of GaAs with the economy and integration of conventional CMOS.

Optional External V_{SS}

For proper operation, the V_{SS_EXT} pin must be grounded or tied to the V_{SS} voltage specified in **Table 2**. When the V_{SS_EXT} pin is grounded, FETs in the switch are biased with an internal negative voltage generator. For applications that require the lowest possible spur performance, V_{SS_EXT} can be applied externally to bypass the internal negative voltage generator.

Absolute Maximum Ratings

Exceeding absolute maximum ratings listed in **Table 1** may cause permanent damage. Operation should be restricted to the limits in **Table 2**. Operation between operating range maximum and absolute maximum for extended periods may reduce reliability.

ESD Precautions

When handling this UltraCMOS device, observe the same precautions as with any other ESD-sensitive devices. Although this device contains circuitry to protect it from damage due to ESD, precautions should be taken to avoid exceeding the rating specified in **Table 1**.

Latch-up Immunity

Unlike conventional CMOS devices, UltraCMOS devices are immune to latch-up.

Table 1 • Absolute Maximum Ratings for PE42512

Parameter/Condition	Min	Max	Unit
Supply voltage, V_{DD}	-0.3	5.5	V
Digital input voltage (V1, V2, V3, V4, LS)	-0.3	3.6	V
RF input power (RFC–RFX, 50 Ω)		See Figure 2	dBm
RF input power into terminated ports, $CW^{(1)}$ (RFX, 50 Ω)		See Figure 2	dBm
Maximum junction temperature		+150	$^{\circ}C$
Storage temperature range	-65	+150	$^{\circ}C$
ESD voltage HBM, all pins ⁽²⁾		1000	V
ESD voltage CDM, all pins ⁽³⁾		1000	V
Notes: 1) 100% duty cycle, all bands, 50 Ω . 2) Human body model (MIL-STD 883 Method 3015). 3) Charged device model (JEDEC JESD22-C101).			

Recommended Operating Conditions

Table 2 lists the recommended operating conditions for the PE42512. Devices should not be operated outside the recommended operating conditions listed below.

Table 2 • Recommended Operating Conditions for PE42512

Parameter	Min	Typ	Max	Unit
Normal mode ($V_{SS_EXT} = 0V$)⁽¹⁾				
Supply voltage, V_{DD}	2.3	3.3	5.5	V
Supply current, I_{DD}		120	200	μA
Bypass mode ($V_{SS_EXT} = -3.4V$)⁽²⁾				
Supply voltage, V_{DD} (Table 3 spec. compliance applies for $V_{DD} \geq 3.4V$)	3.1	3.4	5.5	V
Supply current, I_{DD}		80	160	μA
Negative supply voltage, V_{SS_EXT}	-3.3	-3.0	-2.7	V
Negative supply current, I_{SS}	-40	-16		μA
Normal or Bypass mode				
Digital input high (V1, V2, V3, V4, LS)	1.17		3.6	V
Digital input low (V1, V2, V3, V4, LS)	-0.3		0.6	V
Digital input current V1, V2, V3, V4 LS			5 10	μA μA
RF input power, CW (RFC–RFX) ⁽³⁾			See Figure 2	dBm
RF input power, pulsed (RFC–RFX) ⁽⁴⁾			See Figure 2	dBm
RF input power into terminated ports, CW (RFX) ⁽³⁾			See Figure 2	dBm
Operating temperature range	-40	+25	+105	$^{\circ}C$
Notes:				
1) Normal mode: connect V_{SS_EXT} (pin 10) to GND ($V_{SS_EXT} = 0V$) to enable internal negative voltage generator.				
2) Bypass mode: use V_{SS_EXT} (pin 10) to bypass and disable internal negative voltage generator.				
3) 100% duty cycle, all bands, 50 Ω .				
4) Pulsed, 5% duty cycle of 4620 μs period, 50 Ω .				

Electrical Specifications

Table 3 provides the PE42512 key electrical specifications at +25 °C ($Z_S = Z_L = 50\Omega$), unless otherwise specified. Normal mode⁽¹⁾ is at $V_{DD} = 3.3V$ and $V_{SS_EXT} = 0V$. Bypass mode⁽²⁾ is at $V_{DD} = 3.4V$ and $V_{SS_EXT} = -3.0V$.

Table 3 • PE42512 Electrical Specifications

Parameter	Path	Condition	Min	Typ	Max	Unit
Operating frequency			9 kHz		8 GHz	As shown
Insertion loss ⁽³⁾	RFC–RF1/12	9 kHz–100 MHz		0.7	0.9	dB
		100 MHz–1 GHz		0.8	1.0	dB
		1–2 GHz		0.9	1.1	dB
		2–4 GHz		1.1	1.4	dB
		4–6 GHz		1.3	1.6	dB
		6–8 GHz		2.4	3.0	dB
	RFC–RF2/11	9 kHz–100 MHz		0.8	1.0	dB
		100 MHz–1 GHz		0.9	1.1	dB
		1–2 GHz		1.0	1.3	dB
		2–4 GHz		1.2	1.5	dB
		4–6 GHz		1.4	1.8	dB
		6–8 GHz		1.7	2.0	dB
RFC–RF3/10	9 kHz–100 MHz		0.8	1.0	dB	
	100 MHz–1 GHz		0.9	1.1	dB	
	1–2 GHz		1.1	1.3	dB	
	2–4 GHz		1.3	1.5	dB	
	4–6 GHz		1.4	1.8	dB	
	6–8 GHz		1.4	1.7	dB	
RFC–RF4/9	9 kHz–100 MHz		0.9	1.1	dB	
	100 MHz–1 GHz		1.1	1.3	dB	
	1–2 GHz		1.2	1.5	dB	
	2–4 GHz		1.4	1.7	dB	
	4–6 GHz		1.6	1.9	dB	
	6–8 GHz		2.3	2.7	dB	
RFC–RF5/8	9 kHz–100 MHz		1.0	1.2	dB	
	100 MHz–1 GHz		1.1	1.3	dB	
	1–2 GHz		1.3	1.6	dB	
	2–4 GHz		1.5	1.8	dB	
	4–6 GHz		1.6	1.9	dB	
	6–8 GHz		2.1	2.5	dB	
RFC–RF6/7	9 kHz–100 MHz		1.0	1.2	dB	
	100 MHz–1 GHz		1.1	1.3	dB	
	1–2 GHz		1.4	1.7	dB	
	2–4 GHz		1.7	2.0	dB	
	4–6 GHz		1.7	2.1	dB	
	6–8 GHz		2.4	3.1	dB	

Table 3 • PE42512 Electrical Specifications (Cont.)

Parameter	Path	Condition	Min	Typ	Max	Unit
Isolation ⁽³⁾	RFC–RF1/12	9 kHz–100 MHz	60	63		dB
		100 MHz–1 GHz	42	44		dB
		1–2 GHz	36	38		dB
		2–4 GHz	31	33		dB
		4–6 GHz	26	28		dB
		6–8 GHz	19	22		dB
	RFC–RF2/11	9 kHz–100 MHz	63	66		dB
		100 MHz–1 GHz	47	49		dB
		1–2 GHz	40	43		dB
		2–4 GHz	34	38		dB
		4–6 GHz	30	33		dB
		6–8 GHz	25	27		dB
	RFC–RF3/10	9 kHz–100 MHz	62	66		dB
		100 MHz–1 GHz	48	50		dB
		1–2 GHz	41	44		dB
		2–4 GHz	34	37		dB
		4–6 GHz	30	33		dB
		6–8 GHz	28	30		dB
	RFC–RF4/9	9 kHz–100 MHz	63	67		dB
		100 MHz–1 GHz	50	52		dB
		1–2 GHz	43	46		dB
		2–4 GHz	36	39		dB
		4–6 GHz	31	34		dB
		6–8 GHz	28	30		dB
RFC–RF5/8	9 kHz–100 MHz	64	69		dB	
	100 MHz–1 GHz	56	60		dB	
	1–2 GHz	48	54		dB	
	2–4 GHz	40	45		dB	
	4–6 GHz	33	37		dB	
	6–8 GHz	31	33		dB	
RFC–RF6/7	9 kHz–100 MHz	64	69		dB	
	100 MHz–1 GHz	55	57		dB	
	1–2 GHz	47	52		dB	
	2–4 GHz	36	43		dB	
	4–6 GHz	32	39		dB	
	6–8 GHz	31	37		dB	

Table 3 • PE42512 Electrical Specifications (Cont.)

Parameter	Path	Condition	Min	Typ	Max	Unit
Return loss (active port)	RFC–RF1/12	9 kHz–100 MHz		25		dB
		100 MHz–1 GHz		23		dB
		1–2 GHz		17		dB
		2–4 GHz		16		dB
		4–6 GHz		16		dB
		6–8 GHz		10		dB
	RFC–RF2/11	9 kHz–100 MHz		24		dB
		100 MHz–1 GHz		21		dB
		1–2 GHz		14		dB
		2–4 GHz		14		dB
		4–6 GHz		12		dB
		6–8 GHz		21		dB
	RFC–RF3/10	9 kHz–100 MHz		24		dB
		100 MHz–1 GHz		20		dB
		1–2 GHz		14		dB
		2–4 GHz		13		dB
		4–6 GHz		11		dB
		6–8 GHz		16		dB
	RFC–RF4/9	9 kHz–100 MHz		24		dB
		100 MHz–1 GHz		20		dB
		1–2 GHz		15		dB
		2–4 GHz		14		dB
		4–6 GHz		13		dB
		6–8 GHz		15		dB
RFC–RF5/8	9 kHz–100 MHz		23		dB	
	100 MHz–1 GHz		19		dB	
	1–2 GHz		13		dB	
	2–4 GHz		13		dB	
	4–6 GHz		12		dB	
	6–8 GHz		14		dB	
RFC–RF6/7	9 kHz–100 MHz		23		dB	
	100 MHz–1 GHz		18		dB	
	1–2 GHz		12		dB	
	2–4 GHz		12		dB	
	4–6 GHz		11		dB	
	6–8 GHz		11		dB	

Table 3 • PE42512 Electrical Specifications (Cont.)

Parameter	Path	Condition	Min	Typ	Max	Unit
Return loss (RFC port)	RFC–RF1/12	9 kHz–100 MHz		25		dB
		100 MHz–1 GHz		23		dB
		1–2 GHz		17		dB
		2–4 GHz		17		dB
		4–6 GHz		17		dB
		6–8 GHz		9		dB
	RFC–RF2/11	9 kHz–100 MHz		24		dB
		100 MHz–1 GHz		21		dB
		1–2 GHz		15		dB
		2–4 GHz		15		dB
		4–6 GHz		13		dB
		6–8 GHz		15		dB
	RFC–RF3/10	9 kHz–100 MHz		24		dB
		100 MHz–1 GHz		20		dB
		1–2 GHz		14		dB
		2–4 GHz		14		dB
		4–6 GHz		11		dB
		6–8 GHz		17		dB
	RFC–RF4/9	9 kHz–100 MHz		24		dB
		100 MHz–1 GHz		21		dB
		1–2 GHz		15		dB
		2–4 GHz		15		dB
		4–6 GHz		13		dB
		6–8 GHz		10		dB
RFC–RF5/8	9 kHz–100 MHz		23		dB	
	100 MHz–1 GHz		19		dB	
	1–2 GHz		14		dB	
	2–4 GHz		14		dB	
	4–6 GHz		13		dB	
	6–8 GHz		11		dB	
RFC–RF6/7	9 kHz–100 MHz		23		dB	
	100 MHz–1 GHz		18		dB	
	1–2 GHz		13		dB	
	2–4 GHz		13		dB	
	4–6 GHz		13		dB	
	6–8 GHz		11		dB	

Table 3 • PE42512 Electrical Specifications (Cont.)

Parameter	Path	Condition	Min	Typ	Max	Unit
Return loss (terminated port)	RF1/12	9 kHz–100 MHz		16		dB
		100 MHz–1 GHz		15		dB
		1–2 GHz		15		dB
		2–4 GHz		17		dB
		4–6 GHz		20		dB
		6–8 GHz		15		dB
	RF2/11	9 kHz–100 MHz		16		dB
		100 MHz–1 GHz		16		dB
		1–2 GHz		16		dB
		2–4 GHz		17		dB
		4–6 GHz		20		dB
		6–8 GHz		14		dB
	RF3/10	9 kHz–100 MHz		16		dB
		100 MHz–1 GHz		16		dB
		1–2 GHz		16		dB
		2–4 GHz		17		dB
		4–6 GHz		20		dB
		6–8 GHz		17		dB
	RF4/9	9 kHz–100 MHz		16		dB
		100 MHz–1 GHz		15		dB
		1–2 GHz		15		dB
		2–4 GHz		17		dB
		4–6 GHz		19		dB
		6–8 GHz		18		dB
RF5/8	9 kHz–100 MHz		16		dB	
	100 MHz–1 GHz		16		dB	
	1–2 GHz		16		dB	
	2–4 GHz		17		dB	
	4–6 GHz		20		dB	
	6–8 GHz		16		dB	
RF6/7	9 kHz–100 MHz		16		dB	
	100 MHz–1 GHz		16		dB	
	1–2 GHz		15		dB	
	2–4 GHz		17		dB	
	4–6 GHz		17		dB	
	6–8 GHz		11		dB	

Table 3 • PE42512 Electrical Specifications (Cont.)

Parameter	Path	Condition	Min	Typ	Max	Unit
Relative insertion phase ⁽⁴⁾	RF2–RF1 (RF11–RF12)	1 GHz	–3.3	–2.7	–2.1	Deg
		2 GHz	–6.1	–5.0	–3.8	Deg
		4 GHz	–10.3	–8.1	–5.9	Deg
		6 GHz	–10.9	–7.5	–4.0	Deg
		8 GHz	–10.5	–5.3	–0.1	Deg
	RF3–RF1 (RF10–RF12)	1 GHz	–4.0	–3.3	–2.6	Deg
		2 GHz	–7.2	–5.9	–4.6	Deg
		4 GHz	–11.7	–9.1	–6.5	Deg
		6 GHz	–11.6	–7.4	–3.2	Deg
		8 GHz	–9.4	–3.9	1.7	Deg
	RF4–RF1 (RF9–RF12)	1 GHz	–6.9	–5.8	–4.7	Deg
		2 GHz	–12.4	–10.8	–9.2	Deg
		4 GHz	–23.1	–19.3	–15.5	Deg
		6 GHz	–31.4	–25.6	–19.8	Deg
		8 GHz	–35.8	–27.9	–20.1	Deg
	RF5–RF1 (RF8–RF12)	1 GHz	–8.8	–7.2	–5.7	Deg
		2 GHz	–15.6	–13.5	–11.4	Deg
		4 GHz	–28.2	–24.5	–20.7	Deg
		6 GHz	–39.2	–33.2	–27.2	Deg
		8 GHz	–44.9	–37.8	–30.6	Deg
RF6–RF1 (RF7–RF12)	1 GHz	–11.0	–9.1	–7.3	Deg	
	2 GHz	–19.6	–17.0	–14.4	Deg	
	4 GHz	–35.0	–30.7	–26.5	Deg	
	6 GHz	–50.6	–41.7	–32.7	Deg	
	8 GHz	–61.3	–49.7	–38.2	Deg	
Input 1dB compression point ⁽⁵⁾	RFC–RFX			See Figure 2		dBm
Input 0.1dB compression point ⁽⁵⁾	RFC–RFX			See Figure 2		dBm
Input IP2	RFC–RFX	5 MHz		75		dBm
		100 MHz–8 GHz		105		dBm
Input IP3	RFC–RFX	5 MHz		53		dBm
		100 MHz–8 GHz		60		dBm
RF T _{RISE} /T _{FALL}		10%/90% RF		100	130	ns
Settling time		50% CTRL to 0.05 dB final value		870	1400	ns
Switching time		50% CTRL to 90% or 10% of RF		232	300	ns

Notes:

- 1) Normal mode: connect V_{SS_EXT} (pin 10) to GND (V_{SS_EXT} = 0V) to enable internal negative voltage generator.
- 2) Bypass mode: use V_{SS_EXT} (pin 10) to bypass and disable internal negative voltage generator.
- 3) Insertion loss and isolation performance can be improved by a good RF ground on the LS pin (pin 32).
- 4) Defined with S-parameters, relative insertion phase (RFX–RF1) = ∠S_{(x+1)1} – ∠S₂₁, where incident Port-1 is RFC, response Port-2 = RF1, and response Port-(x+1) = RFX.
- 5) The input 1dB and 0.1dB compression points are linearity figures of merit. Refer to Table 2 for the RF input power (50Ω).

Switching Frequency

The PE42512 has a maximum 25 kHz switching frequency in normal mode (pin 10 tied to ground). A faster switching frequency is available in bypass mode (pin 10 tied to V_{SS_EXT}). The rate at which the PE42512 can be switched is then limited to the switching time as specified in **Table 3**.

Switching frequency describes the time duration between switching events. Switching time is the time duration between the point the control signal reached 50% of the final value and the point the output signal reaches within 10% or 90% of its target value.

Spur-free Performance

The PE42512 spur fundamental occurs around 5 MHz. Its typical performance in normal mode is –162 dBm/Hz (pin 10 tied to ground), with 45 kHz bandwidth. If spur-free performance is desired, the internal negative voltage generator can be disabled by applying a negative voltage to V_{SS_EXT} (pin 10).

Hot-Switching Capability

The maximum hot switching capability of the PE42512 is 20 dBm above 100 MHz. Hot switching occurs when RF power is applied while switching between RF ports.

Thermal Data

Psi-JT (Ψ_{JT}), junction top-of-package, is a thermal metric to estimate junction temperature of a device on the customer application PCB (JEDEC JESD51-2).

$$\Psi_{JT} = (T_J - T_T)/P$$

where

Ψ_{JT} = junction-to-top of package characterization parameter, °C/W

T_J = die junction temperature, °C

T_T = package temperature (top surface, in the center), °C

P = power dissipated by device, Watts

Table 4 • Thermal Data for PE42512

Parameter	Typ	Unit
Ψ_{JT}	20	°C/W
Θ_{JA} , junction-to-ambient thermal resistance	58	°C/W

Control Logic

Table 5 provides the control logic truth table for PE42512.

Table 5 • Truth Table for PE42512

LS ⁽¹⁾	V4	V3	V2	V1	RFC- RF1	RFC- RF2	RFC- RF3	RFC- RF4	RFC- RF5	RFC- RF6	RFC- RF7	RFC- RF8	RFC- RF9	RFC- RF10	RFC- RF11	RFC- RF12
0	0	0	0	0	ON	OFF	OFF	OFF	OFF	OFF	OFF	OFF	OFF	OFF	OFF	OFF
0	1	0	0	0	OFF	ON	OFF	OFF	OFF	OFF	OFF	OFF	OFF	OFF	OFF	OFF
0	0	1	0	0	OFF	OFF	ON	OFF	OFF	OFF	OFF	OFF	OFF	OFF	OFF	OFF
0	1	1	0	0	OFF	OFF	OFF	ON	OFF	OFF	OFF	OFF	OFF	OFF	OFF	OFF
0	0	0	1	0	OFF	OFF	OFF	OFF	ON	OFF	OFF	OFF	OFF	OFF	OFF	OFF
0	1	0	1	0	OFF	OFF	OFF	OFF	OFF	ON	OFF	OFF	OFF	OFF	OFF	OFF
0	0	1	1	0	OFF	OFF	OFF	OFF	OFF	OFF	ON	OFF	OFF	OFF	OFF	OFF
0	1	1	1	0	OFF	OFF	OFF	OFF	OFF	OFF	OFF	ON	OFF	OFF	OFF	OFF
0	0	0	0	1	OFF	OFF	OFF	OFF	OFF	OFF	OFF	OFF	ON	OFF	OFF	OFF
0	1	0	0	1	OFF	OFF	OFF	OFF	OFF	OFF	OFF	OFF	OFF	ON	OFF	OFF
0	0	1	0	1	OFF	OFF	OFF	OFF	OFF	OFF	OFF	OFF	OFF	OFF	ON	OFF
0	1	1	0	1	OFF	OFF	OFF	OFF	OFF	OFF	OFF	OFF	OFF	OFF	OFF	ON
1	1	1	0	1	ON	OFF	OFF	OFF	OFF	OFF	OFF	OFF	OFF	OFF	OFF	OFF
1	0	1	0	1	OFF	ON	OFF	OFF	OFF	OFF	OFF	OFF	OFF	OFF	OFF	OFF
1	1	0	0	1	OFF	OFF	ON	OFF	OFF	OFF	OFF	OFF	OFF	OFF	OFF	OFF
1	0	0	0	1	OFF	OFF	OFF	ON	OFF	OFF	OFF	OFF	OFF	OFF	OFF	OFF
1	1	1	1	0	OFF	OFF	OFF	OFF	ON	OFF	OFF	OFF	OFF	OFF	OFF	OFF
1	0	1	1	0	OFF	OFF	OFF	OFF	OFF	ON	OFF	OFF	OFF	OFF	OFF	OFF
1	1	0	1	0	OFF	OFF	OFF	OFF	OFF	OFF	ON	OFF	OFF	OFF	OFF	OFF
1	0	0	1	0	OFF	OFF	OFF	OFF	OFF	OFF	OFF	ON	OFF	OFF	OFF	OFF
1	1	1	0	0	OFF	OFF	OFF	OFF	OFF	OFF	OFF	OFF	ON	OFF	OFF	OFF
1	0	1	0	0	OFF	OFF	OFF	OFF	OFF	OFF	OFF	OFF	OFF	ON	OFF	OFF
1	1	0	0	0	OFF	OFF	OFF	OFF	OFF	OFF	OFF	OFF	OFF	OFF	ON	OFF
1	0	0	0	0	OFF	OFF	OFF	OFF	OFF	OFF	OFF	OFF	OFF	OFF	OFF	ON
X ⁽²⁾	0	0	1	1	OFF	OFF	OFF	OFF	OFF	OFF	OFF	OFF	OFF	OFF	OFF	OFF

Notes:

- 1) LS has an internal 1 MΩ pull-up resistor to logic high. Connect LS to GND externally to generate a logic 0. Leaving LS floating will generate a logic 1.
- 2) LS = don't care, V4 = 0, V3 = 0, V2 = V1 = 1, all ports are terminated to provide an all isolated state.

Power De-rating Curve

Figure 2 shows the power de-rating curve showing P1dB compression, P0.1dB compression, maximum RF input power (pulsed), maximum RF input power (CW), absolute maximum RF terminated power (CW), and maximum RF terminated power (CW).

Figure 2 • Power De-rating Curve, 9 kHz–8 GHz, –40 °C to +105 °C Ambient, 50Ω

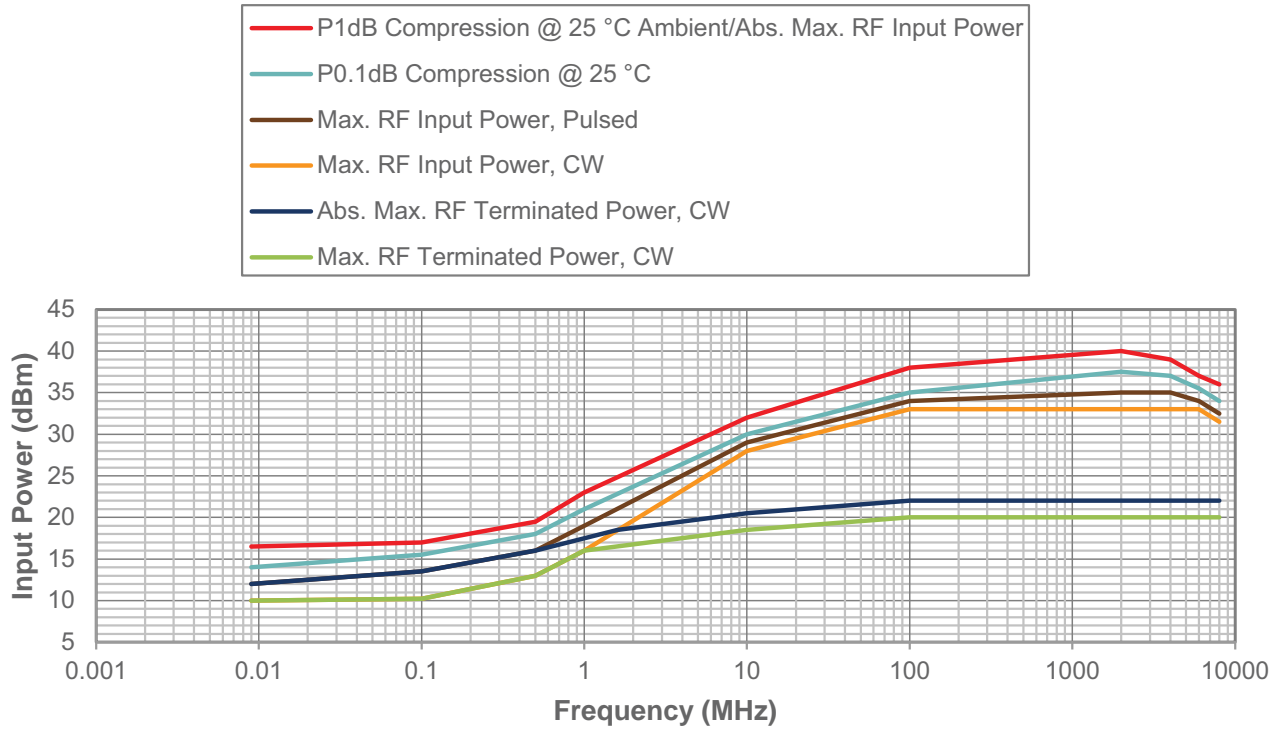

Isolation Matrix

Table 6 provides RFC-to-port isolation and Table 7 provides port-to-port isolation at +25 °C, $V_{DD} = 3.3V$ ($Z_S = Z_L = 50\Omega$). Normal mode⁽¹⁾ is at $V_{DD} = 3.3V$ and $V_{SS_EXT} = 0V$. Bypass mode⁽²⁾ is at $V_{DD} = 3.4V$ and $V_{SS_EXT} = -3.0V$.

Table 6 • RFC-to-Port Isolation

"ON" Port	Frequency	Isolation (dB)											
		RF1	RF2	RF3	RF4	RF5	RF6	RF7	RF8	RF9	RF10	RF11	RF12
RF1	9 kHz–100 MHz	–	70	68	87	87	87	91	93	89	88	83	75
	100 MHz–1 GHz	–	67	54	63	65	66	76	75	72	64	61	53
	1–2 GHz	–	51	48	57	58	59	67	68	65	58	55	48
	2–4 GHz	–	41	41	50	51	49	55	61	59	52	51	43
	4–6 GHz	–	33	34	44	45	44	53	59	55	48	47	39
	6–8 GHz	–	27	30	40	41	44	49	54	51	44	44	36
RF2	9 kHz–100 MHz	67	–	71	91	90	88	93	91	90	86	81	74
	100 MHz–1 GHz	51	–	66	76	68	68	76	74	71	63	60	52
	1–2 GHz	44	–	54	64	62	61	67	68	64	57	54	47
	2–4 GHz	35	–	44	55	54	50	56	61	59	52	50	43
	4–6 GHz	28	–	36	47	48	46	54	59	55	47	47	40
	6–8 GHz	23	–	32	43	44	46	49	55	51	44	44	37
RF3	9 kHz–100 MHz	64	67	–	80	91	93	92	90	89	86	80	73
	100 MHz–1 GHz	45	52	–	58	80	69	76	74	70	63	59	51
	1–2 GHz	40	47	–	51	69	63	66	68	64	57	53	46
	2–4 GHz	34	42	–	44	59	52	55	61	58	51	50	43
	4–6 GHz	31	37	–	39	51	48	54	60	55	47	47	40
	6–8 GHz	28	31	–	35	46	48	49	56	52	44	45	39
RF4	9 kHz–100 MHz	63	66	67	–	70	69	91	89	90	85	80	73
	100 MHz–1 GHz	44	50	53	–	68	57	75	74	69	63	59	51
	1–2 GHz	39	45	47	–	69	52	65	67	63	57	53	46
	2–4 GHz	34	39	41	–	54	43	54	60	57	51	49	43
	4–6 GHz	32	35	36	–	42	39	52	60	55	48	47	40
	6–8 GHz	29	32	33	–	37	37	47	56	52	45	46	39
RF5	9 kHz–100 MHz	63	66	67	68	–	70	92	92	90	85	81	73
	100 MHz–1 GHz	44	50	51	55	–	67	76	73	69	62	59	51
	1–2 GHz	38	44	45	50	–	60	66	67	63	56	53	46
	2–4 GHz	33	38	38	43	–	49	54	60	57	51	50	43
	4–6 GHz	31	35	34	36	–	42	51	59	55	47	47	40
	6–8 GHz	29	32	31	33	–	37	46	54	52	45	46	39
RF6	9 kHz–100 MHz	63	66	66	67	69	–	91	92	87	85	80	74
	100 MHz–1 GHz	44	49	50	52	60	–	70	75	70	63	59	51
	1–2 GHz	38	43	44	46	54	–	60	67	63	56	53	46
	2–4 GHz	33	38	37	39	45	–	46	58	56	50	49	42
	4–6 GHz	31	34	33	34	37	–	44	57	53	47	47	40
	6–8 GHz	29	31	30	30	33	–	39	51	50	45	45	38

Table 6 • RFC-to-Port Isolation (Cont.)

“ON” Port	Frequency	Isolation (dB)											
		RF1	RF2	RF3	RF4	RF5	RF6	RF7	RF8	RF9	RF10	RF11	RF12
RF7	9 kHz–100 MHz	69	79	85	92	92	91	–	69	67	66	67	65
	100 MHz–1 GHz	47	57	62	69	74	71	–	63	53	51	50	47
	1–2 GHz	42	51	56	63	67	61	–	57	46	44	45	41
	2–4 GHz	37	45	49	55	57	49	–	46	39	38	39	37
	4–6 GHz	34	42	46	53	56	45	–	38	34	33	35	34
	6–8 GHz	31	38	43	49	52	42	–	34	31	30	33	33
RF8	9 kHz–100 MHz	69	79	83	92	89	92	70	–	68	67	66	65
	100 MHz–1 GHz	47	57	62	68	72	80	65	–	57	51	51	47
	1–2 GHz	42	51	56	62	66	70	57	–	52	45	45	42
	2–4 GHz	37	45	49	56	59	55	48	–	44	39	39	37
	4–6 GHz	34	43	46	53	57	50	42	–	37	34	35	34
	6–8 GHz	31	38	43	50	54	50	38	–	33	31	33	34
RF9	9 kHz–100 MHz	69	79	83	91	91	91	69	70	–	68	67	65
	100 MHz–1 GHz	47	57	62	69	72	77	59	68	–	54	52	47
	1–2 GHz	41	51	56	62	66	69	53	65	–	48	46	42
	2–4 GHz	36	45	50	56	59	55	45	53	–	42	40	37
	4–6 GHz	34	43	46	54	57	51	42	42	–	37	36	35
	6–8 GHz	32	38	44	51	54	49	39	37	–	33	34	34
RF10	9 kHz–100 MHz	69	79	83	92	91	92	93	91	78	–	68	66
	100 MHz–1 GHz	47	57	62	69	73	76	71	84	56	–	55	49
	1–2 GHz	42	51	56	63	66	69	64	69	50	–	50	43
	2–4 GHz	37	46	50	57	59	55	53	59	43	–	42	37
	4–6 GHz	34	43	46	54	57	52	53	52	38	–	37	33
	6–8 GHz	31	38	43	51	54	51	50	46	34	–	34	32
RF11	9 kHz–100 MHz	69	79	87	91	91	93	88	88	91	71	–	69
	100 MHz–1 GHz	48	58	62	70	73	76	69	70	76	64	–	59
	1–2 GHz	42	51	56	63	67	69	61	63	63	53	–	44
	2–4 GHz	36	45	50	57	59	55	51	54	54	45	–	35
	4–6 GHz	34	43	46	54	57	51	51	49	48	37	–	32
	6–8 GHz	31	38	43	50	54	51	48	45	44	32	–	30
RF12	9 kHz–100 MHz	70	80	86	90	89	94	87	88	86	68	70	–
	100 MHz–1 GHz	48	59	63	71	74	77	67	66	64	55	60	–
	1–2 GHz	42	52	57	64	67	70	59	59	58	48	48	–
	2–4 GHz	36	46	50	57	59	56	50	51	50	40	40	–
	4–6 GHz	33	43	46	53	57	51	49	46	45	34	36	–
	6–8 GHz	30	37	43	50	53	50	46	42	41	30	33	–

Notes:

- 1) Normal mode: connect V_{SS_EXT} (pin 10) to GND (V_{SS_EXT} = 0V) to enable internal negative voltage generator.
- 2) Bypass mode: use V_{SS_EXT} (pin 10) to bypass and disable internal negative voltage generator.

Table 7 • Port-to-Port Isolation

"ON" Port	Frequency	Isolation (dB)											
		RF1	RF2	RF3	RF4	RF5	RF6	RF7	RF8	RF9	RF10	RF11	RF12
RF1	9 kHz–100 MHz	–	63	67	81	84	85	91	90	90	87	91	87
	100 MHz–1 GHz	–	44	50	59	63	64	79	79	78	70	74	66
	1–2 GHz	–	38	44	53	56	57	68	72	70	63	62	58
	2–4 GHz	–	32	37	47	49	48	56	64	62	55	52	49
	4–6 GHz	–	28	32	43	45	44	53	63	59	50	48	44
	6–8 GHz	–	23	28	38	41	43	49	58	54	46	44	40
RF2	9 kHz–100 MHz	63	–	62	76	82	83	92	92	91	91	90	93
	100 MHz–1 GHz	44	–	42	54	60	62	80	80	80	72	77	77
	1–2 GHz	38	–	37	48	54	56	68	74	73	65	63	62
	2–4 GHz	33	–	31	43	48	48	56	65	65	57	55	54
	4–6 GHz	29	–	27	39	44	44	54	65	61	52	51	49
	6–8 GHz	23	–	24	36	41	44	50	58	56	47	48	44
RF3	9 kHz–100 MHz	68	65	–	68	78	81	90	92	92	90	91	91
	100 MHz–1 GHz	54	47	–	46	56	60	80	81	83	74	73	71
	1–2 GHz	48	41	–	40	50	54	69	75	75	67	63	61
	2–4 GHz	42	36	–	36	45	47	56	67	66	58	56	56
	4–6 GHz	36	32	–	32	41	44	54	65	63	52	54	52
	6–8 GHz	30	29	–	29	38	43	50	59	58	48	51	50
RF4	9 kHz–100 MHz	69	68	64	–	63	67	90	90	93	90	91	88
	100 MHz–1 GHz	57	54	46	–	44	50	78	82	83	76	72	70
	1–2 GHz	52	48	40	–	38	44	67	73	74	67	63	60
	2–4 GHz	45	42	35	–	33	38	54	65	66	58	56	56
	4–6 GHz	38	37	32	–	29	34	52	65	62	52	54	53
	6–8 GHz	32	33	31	–	26	33	48	60	58	49	53	52
RF5	9 kHz–100 MHz	70	69	67	63	–	63	88	89	90	89	91	87
	100 MHz–1 GHz	58	57	51	45	–	45	74	81	83	76	72	69
	1–2 GHz	54	51	45	39	–	39	65	72	74	68	63	60
	2–4 GHz	46	44	39	34	–	34	53	65	65	58	56	56
	4–6 GHz	37	37	34	31	–	31	53	64	62	53	54	53
	6–8 GHz	33	34	32	30	–	29	50	59	58	49	51	51
RF6	9 kHz–100 MHz	69	69	68	67	64	–	85	91	91	91	89	88
	100 MHz–1 GHz	59	58	53	50	46	–	65	76	81	76	72	69
	1–2 GHz	55	52	47	44	41	–	58	69	72	67	63	60
	2–4 GHz	46	44	40	38	36	–	45	60	63	57	55	55
	4–6 GHz	37	37	35	34	33	–	45	60	60	52	53	52
	6–8 GHz	33	34	32	32	32	–	43	56	56	48	50	49

Table 7 • Port-to-Port Isolation (Cont.)

"ON" Port	Frequency	Isolation (dB)											
		RF1	RF2	RF3	RF4	RF5	RF6	RF7	RF8	RF9	RF10	RF11	RF12
RF7	9 kHz–100 MHz	81	88	92	93	89	86	–	64	67	68	69	68
	100 MHz–1 GHz	60	69	78	81	75	64	–	46	50	52	57	55
	1–2 GHz	52	59	68	71	68	57	–	41	44	46	50	49
	2–4 GHz	46	53	58	62	60	45	–	36	38	40	42	40
	4–6 GHz	41	46	53	60	59	45	–	34	34	35	37	35
	6–8 GHz	38	42	48	57	58	46	–	33	33	33	34	32
RF8	9 kHz–100 MHz	81	88	90	90	89	90	63	–	63	67	69	68
	100 MHz–1 GHz	60	68	78	83	79	74	45	–	44	51	56	54
	1–2 GHz	52	59	69	74	73	67	40	–	39	45	50	48
	2–4 GHz	46	53	60	66	65	53	34	–	34	39	42	41
	4–6 GHz	41	46	53	61	62	53	32	–	31	34	37	35
	6–8 GHz	37	41	48	57	59	52	30	–	30	32	34	33
RF9	9 kHz–100 MHz	81	89	89	91	92	94	67	63	–	64	68	68
	100 MHz–1 GHz	60	68	79	82	81	77	51	44	–	46	53	53
	1–2 GHz	52	59	69	74	73	70	45	38	–	40	47	47
	2–4 GHz	46	53	60	66	65	55	38	33	–	35	41	40
	4–6 GHz	41	46	53	61	62	52	36	29	–	32	37	36
	6–8 GHz	37	41	48	56	58	50	34	26	–	31	35	33
RF10	9 kHz–100 MHz	81	89	92	91	90	91	82	78	67	–	64	67
	100 MHz–1 GHz	60	69	78	84	81	80	61	56	45	–	46	51
	1–2 GHz	52	59	69	75	75	72	54	50	40	–	41	45
	2–4 GHz	46	53	60	67	67	57	47	45	35	–	36	40
	4–6 GHz	41	46	53	62	62	53	47	41	32	–	32	35
	6–8 GHz	37	41	47	56	58	51	45	38	29	–	31	32
RF11	9 kHz–100 MHz	84	89	91	91	89	91	84	82	76	62	–	63
	100 MHz–1 GHz	63	72	74	80	81	79	63	60	54	42	–	43
	1–2 GHz	53	61	67	73	74	73	56	54	48	36	–	37
	2–4 GHz	46	54	59	66	67	57	48	48	43	31	–	35
	4–6 GHz	41	46	52	61	62	52	48	45	39	27	–	32
	6–8 GHz	36	41	47	56	58	51	45	41	36	24	–	29
RF12	9 kHz–100 MHz	88	93	93	90	90	92	86	84	82	67	63	–
	100 MHz–1 GHz	70	77	71	79	78	78	64	63	59	50	43	–
	1–2 GHz	56	62	65	71	73	72	58	57	53	44	38	–
	2–4 GHz	47	54	57	64	65	56	49	50	47	38	34	–
	4–6 GHz	40	45	50	59	61	52	49	46	43	33	31	–
	6–8 GHz	35	40	46	55	58	50	45	42	39	29	28	–

Typical Performance Data

Figure 3–Figure 20 show the typical performance data at +25 °C, $V_{DD} = 3.3V$ ($Z_S = Z_L = 50\Omega$), unless otherwise specified.

Figure 3 • Insertion Loss vs. Frequency (RFC–RFX)

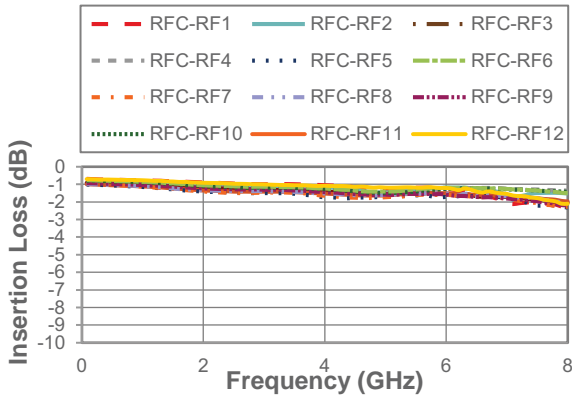

Figure 5 • Insertion Loss vs. Frequency Over V_{DD} (RFC–RF1)

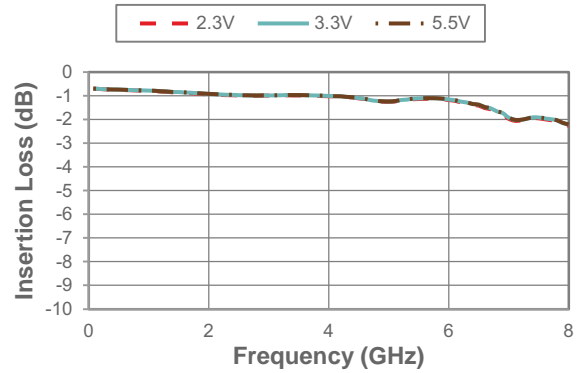

Figure 4 • Insertion Loss vs. Frequency Over Temperature (RFC–RF1)

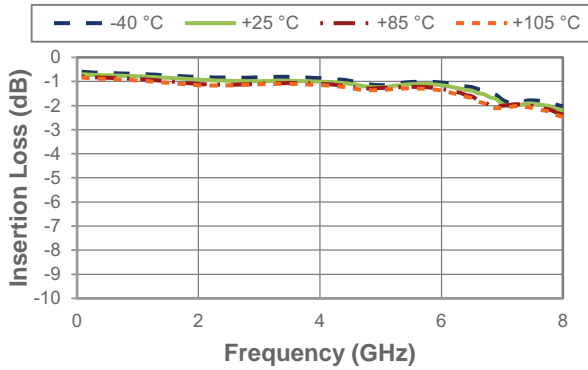

Figure 6 • RFC Port Return Loss vs. Frequency

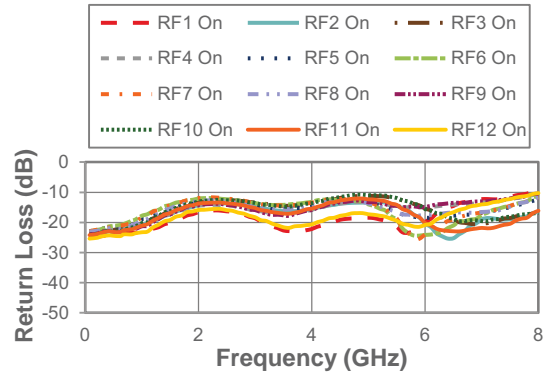

Figure 7 • RFC Port Return Loss vs. Frequency Over Temperature (RF1 On)

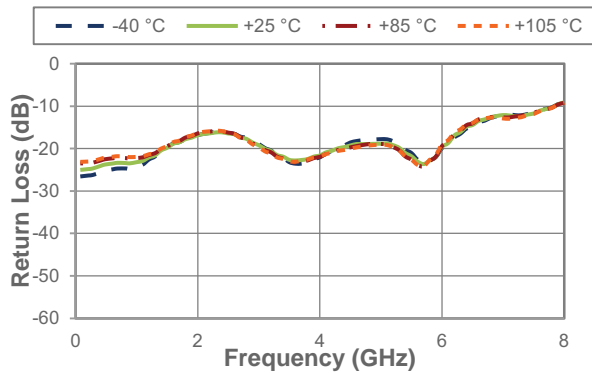

Figure 10 • RF1 Active Port Return Loss vs. Frequency Over Temperature

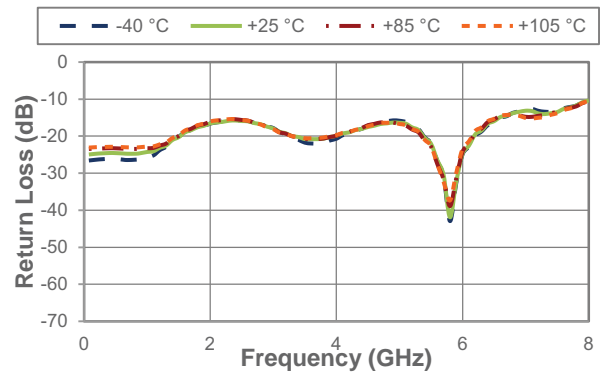

Figure 8 • RFC Port Return Loss vs. Frequency Over V_{DD} (RF1 On)

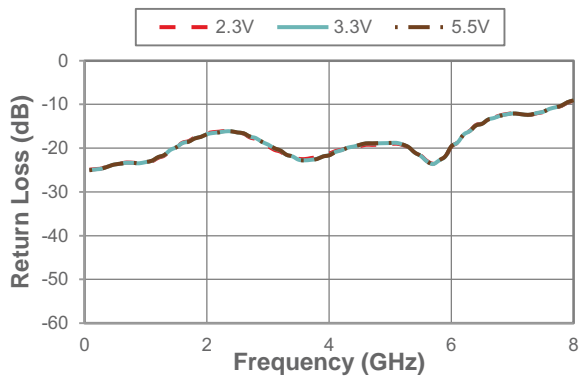

Figure 11 • RF1 Active Port Return Loss vs. Frequency Over V_{DD}

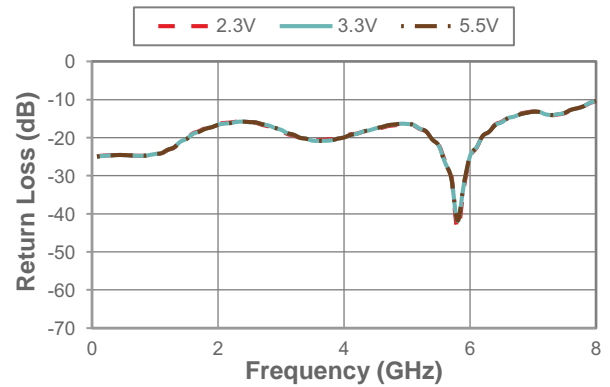

Figure 9 • Active Port Return Loss vs. Frequency

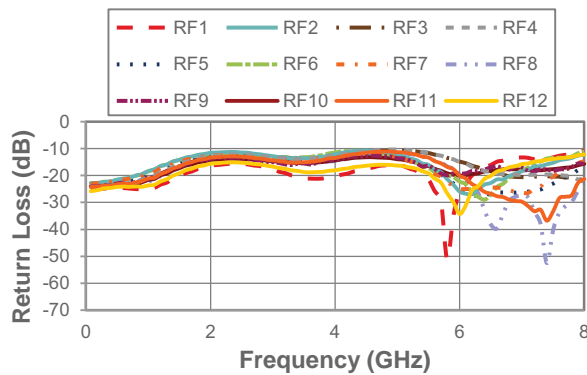

Figure 12 • Terminated Port Return Loss vs. Frequency (RF1 On)

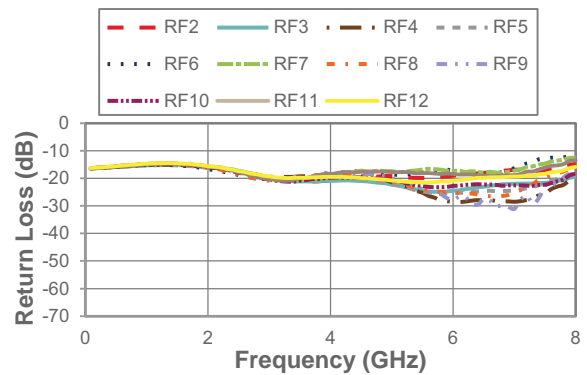

Figure 13 • RF2 Terminated Port Return Loss vs. Frequency Over Temperature (RF1 On)

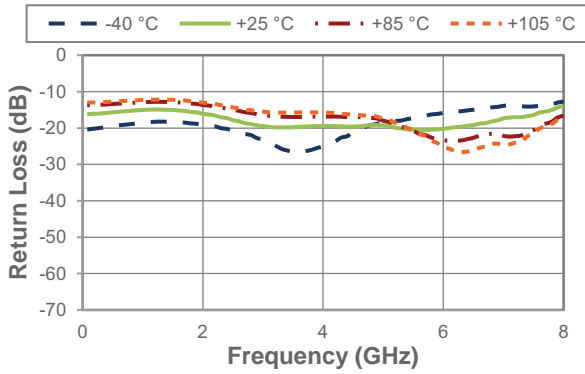

Figure 16 • Isolation vs. Frequency Over V_{DD} (RF1–RF2, RF1 On)

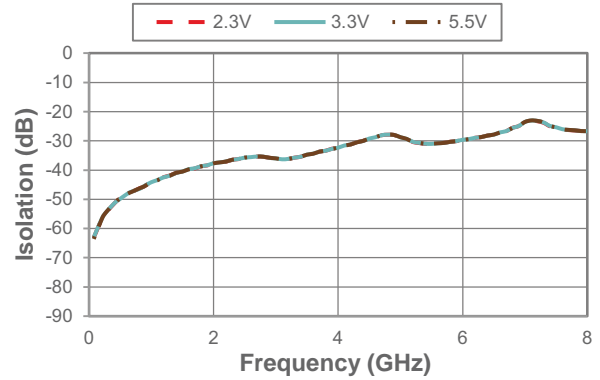

Figure 14 • RF2 Terminated Port Return Loss vs. Frequency Over V_{DD} (RF1 On)

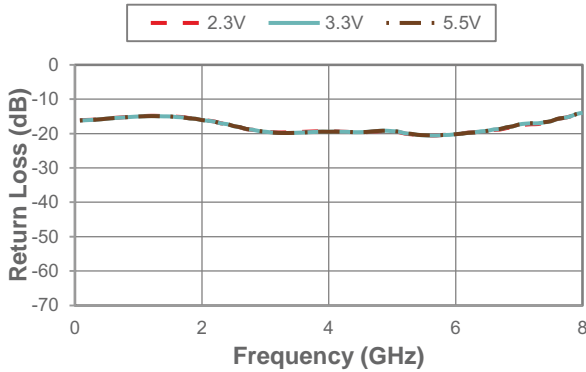

Figure 17 • Isolation vs. Frequency Over Temperature (RFC–RF2, RF1 On)

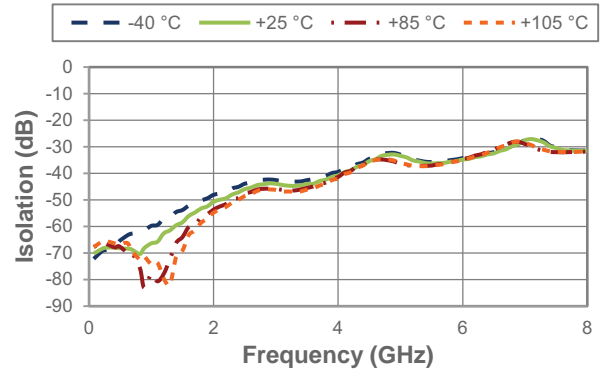

Figure 15 • Isolation vs. Frequency Over Temperature (RF1–RF2, RF1 On)

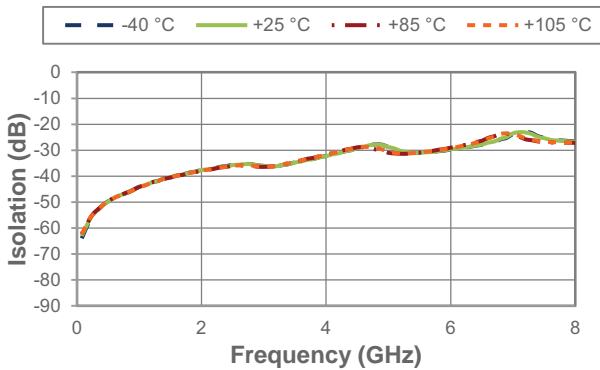

Figure 18 • Isolation vs. Frequency Over V_{DD} (RFC–RF2, RF1 On)

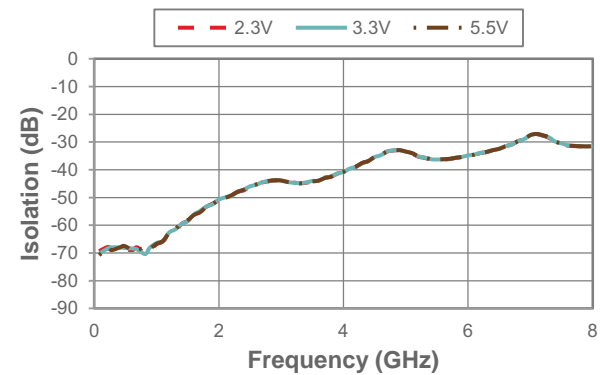

Figure 19 • IIP2 vs. RF Port Measured

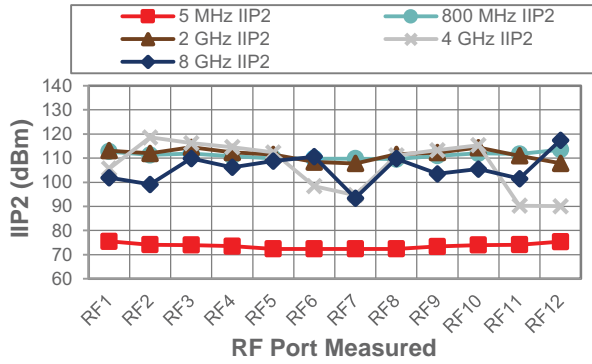
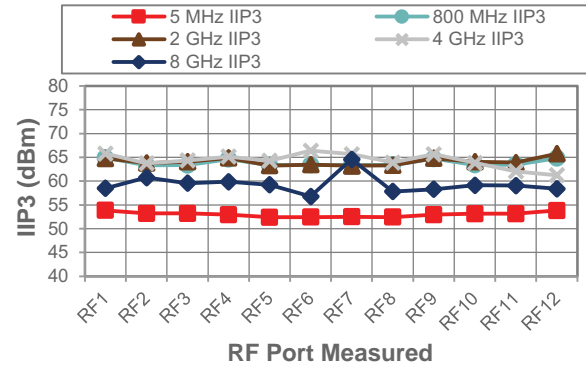

Figure 20 • IIP3 vs. RF Port Measured



Evaluation Kit

The high-throw count RF switch evaluation kit (EVK) includes hardware required to control and evaluate the functionality of the high-throw count switches. The high-throw count RF switch evaluation software can be downloaded at www.psemi.com and requires a PC running Windows® operating system to control the USB interface board. Refer to the *Multi-throw Count RF Switch Evaluation Kit (EVK) User's Manual* for more information.

Figure 21 • Evaluation Board Layout for PE42512

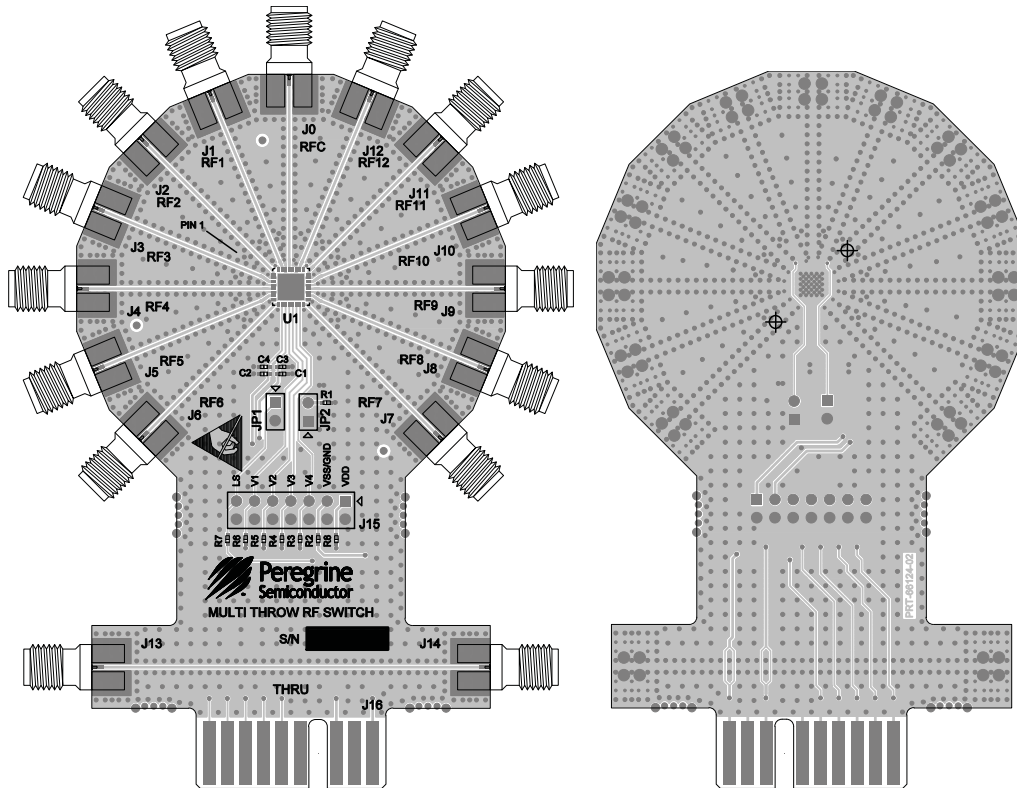

Pin Information

This section provides pinout information for the PE42512. Figure 22 shows the pin map of this device for the available package. Table 8 provides a description for each pin.

Figure 22 • Pin Configuration (Top View)

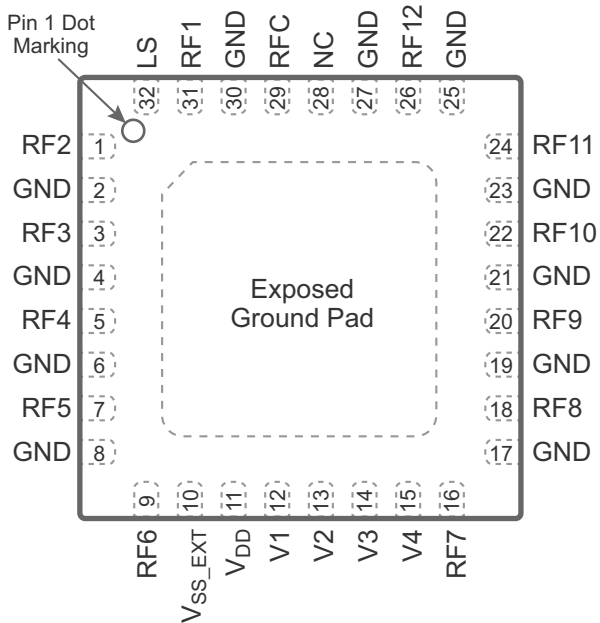

Table 8 • Pin Descriptions for PE42512 (Cont.)

Pin No.	Pin Name	Description
13	V2	Digital control logic input 2
14	V3	Digital control logic input 3
15	V4	Digital control logic input 4
16	RF7 ⁽¹⁾	RF port 7
18	RF8 ⁽¹⁾	RF port 8
20	RF9 ⁽¹⁾	RF port 9
22	RF10 ⁽¹⁾	RF port 10
24	RF11 ⁽¹⁾	RF port 11
26	RF12 ⁽¹⁾	RF port 12
28	NC ⁽³⁾	No connect
29	RFC ⁽¹⁾	RF common port
31	RF1 ⁽¹⁾	RF port 1
32	LS	Logic Select—used to determine the definition for V1, V2, V3 and V4 pins
Pad	GND	Exposed pad: ground for proper operation

Notes:

- 1) RF pins 1, 3, 5, 7, 9, 16, 18, 20, 22, 24, 26, 29 and 31 must be at 0 VDC. The RF pins do not require DC blocking capacitors for proper operation if the 0 VDC requirement is met.
- 2) Use V_{SS_EXT} (pin 10) to bypass and disable internal negative voltage generator. Connect V_{SS_EXT} (pin 10) to GND (V_{SS_EXT} = 0V) to enable internal negative voltage generator.
- 3) Pin 28 (NC) can be connected to GND or left not connected externally.

Table 8 • Pin Descriptions for PE42512

Pin No.	Pin Name	Description
1	RF2 ⁽¹⁾	RF port 2
2, 4, 6, 8, 17, 19, 21, 23, 25, 27, 30	GND	Ground
3	RF3 ⁽¹⁾	RF port 3
5	RF4 ⁽¹⁾	RF port 4
7	RF5 ⁽¹⁾	RF port 5
9	RF6 ⁽¹⁾	RF port 6
10	V _{SS_EXT} ⁽²⁾	External V _{SS} negative voltage control
11	V _{DD}	Supply voltage (nominal 3.3V)
12	V1	Digital control logic input 1

Packaging Information

This section provides packaging data including the moisture sensitivity level, package drawing, package marking and tape-and-reel information.

Moisture Sensitivity Level

The moisture sensitivity level rating for the PE42512 in the 32-lead 5 × 5 × 0.85 mm QFN package is MSL1.

Package Drawing

Figure 23 • Package Mechanical Drawing for 32-lead 5 × 5 × 0.85 mm QFN

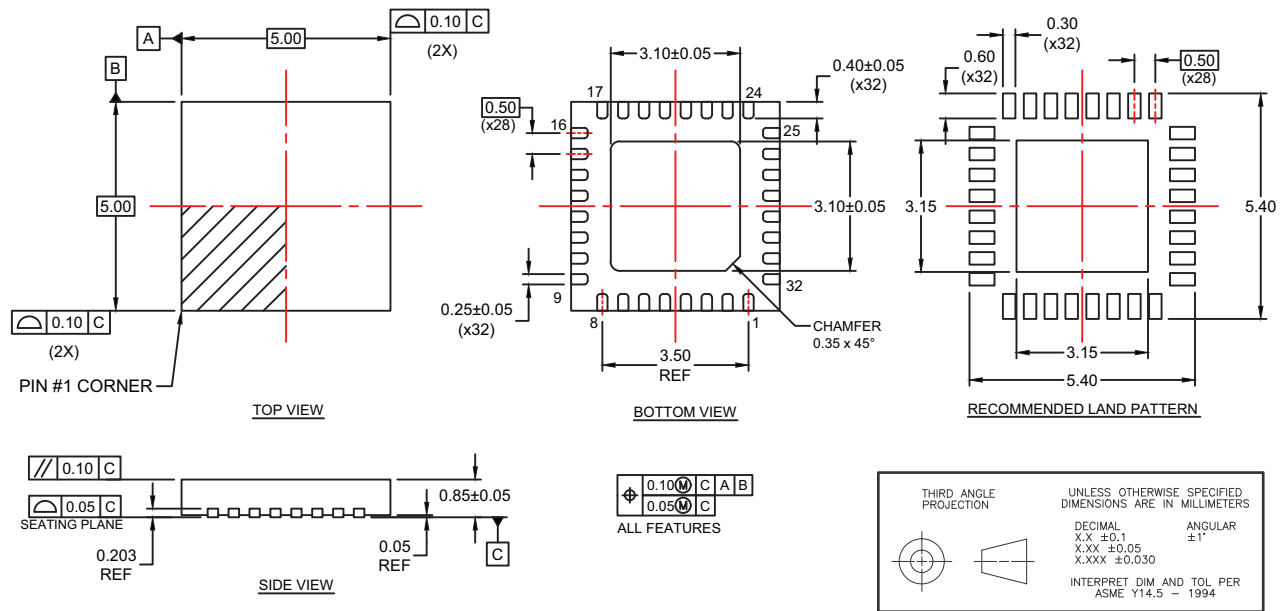

Top-Marking Specification

Figure 24 • Package Marking Specifications for PE42512

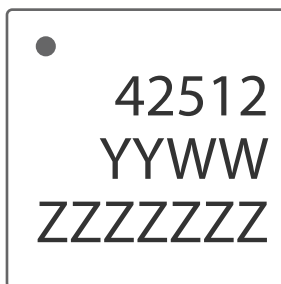

- = Pin 1 indicator
- YY = Last two digits of assembly year
- WW = Assembly work week
- ZZZZZZZ = Assembly lot code (Maximum seven characters)

Tape and Reel Specification

Figure 25 • Tape and Reel Specifications for 32-lead 5 × 5 × 0.85 mm QFN

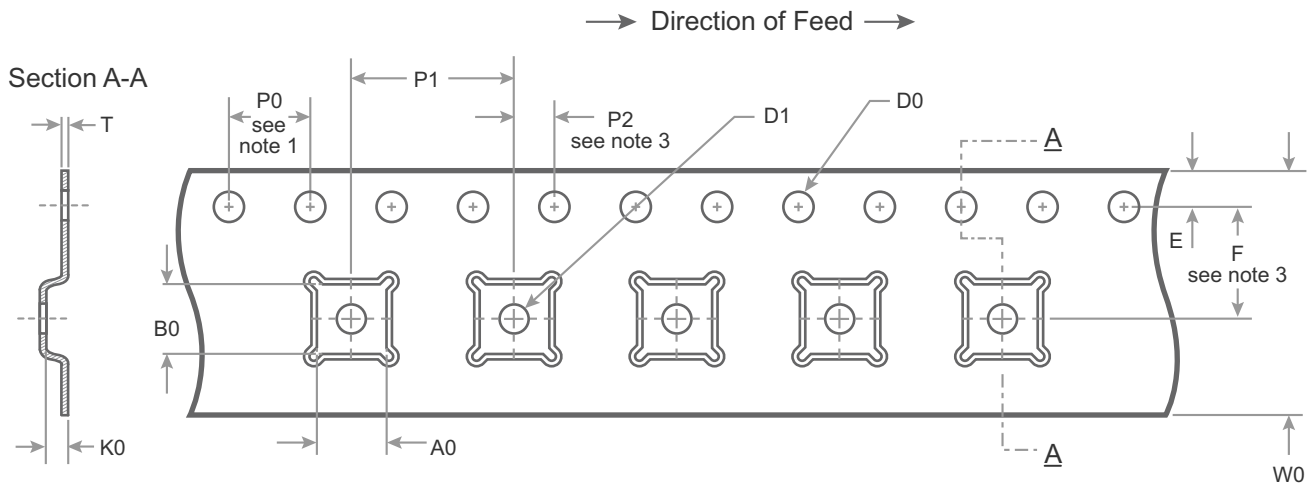

A0	5.25
B0	5.25
K0	1.10
D0	1.50 + 0.1/ -0.0
D1	1.5 min
E	1.75 ± 0.10
F	5.50 ± 0.05
P0	4.00
P1	8.00
P2	2.00 ± 0.05
T	0.30 ± 0.05
W0	12.00 ± 0.30

Notes:

1. 10 Sprocket hole pitch cumulative tolerance ±0.2
2. Camber in compliance with EIA 481
3. Pocket position relative to sprocket hole measured as true position of pocket, not pocket hole

Dimensions are in millimeters unless otherwise specified

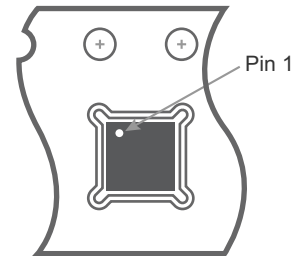

Device Orientation in Tape

Ordering Information

Table 9 lists the available ordering codes for the PE42512 as well as available shipping methods.

Table 9 • Order Codes for PE42512

Order Codes	Description	Packaging	Shipping Method
PE42512A-X	PE42512 SP12T RF switch	Green 32-lead 5 × 5 mm QFN	500 units/T&R
EK42512-02	PE42512 Evaluation kit	Evaluation kit	1/Box

Document Categories

Advance Information

The product is in a formative or design stage. The datasheet contains design target specifications for product development. Specifications and features may change in any manner without notice.

Preliminary Specification

The datasheet contains preliminary data. Additional data may be added at a later date. Peregrine reserves the right to change specifications at any time without notice in order to supply the best possible product.

Product Specification

The datasheet contains final data. In the event Peregrine decides to change the specifications, Peregrine will notify customers of the intended changes by issuing a CNF (Customer Notification Form).

Sales Contact

For additional information, contact Sales at sales@psemi.com.

Disclaimers

The information in this document is believed to be reliable. However, Peregrine assumes no liability for the use of this information. Use shall be entirely at the user's own risk. No patent rights or licenses to any circuits described in this document are implied or granted to any third party. Peregrine's products are not designed or intended for use in devices or systems intended for surgical implant, or in other applications intended to support or sustain life, or in any application in which the failure of the Peregrine product could create a situation in which personal injury or death might occur. Peregrine assumes no liability for damages, including consequential or incidental damages, arising out of the use of its products in such applications.

Patent Statement

Peregrine products are protected under one or more of the following U.S. patents: patents.psemi.com

Copyright and Trademark

©2017, Peregrine Semiconductor Corporation. All rights reserved. The Peregrine name, logo, UTSi and UltraCMOS are registered trademarks and HaRP, MultiSwitch and DuNE are trademarks of Peregrine Semiconductor Corp.