

# SPECIFICATION

- Part No. : **MA412.A.BI.001**
- Product Name : MA412 Storm 2in1 Screwmount Antenna  
LTE MIMO 2in1
- Features : 2\* LTE MIMO 698~960MHz/1710~2170MHz/  
2490~2690MHz Antenna  
Screw-Mount [Permanent Mount]  
Worldwide 4G Bands including 3G and 2G  
Suitable for worldwide HSPA/GSM/GPRS/CDMA/UMTS  
Aerodynamic, Super Low-profile Vandal Resistant Housing  
IP67 Enclosure  
Dims: 216.24\*93.25\*30.95mm  
0.3M CFD-200 with Fakra connectors as standard  
Custom Cables and Connectors Available  
Product conforms to the EMC directive 2014/30/EU.  
**RoHS Compliant**



## 1. Introduction

The Storm MA412 LTE MIMO antenna is a low profile, heavy-duty, fully IP67 waterproof external M2M antenna for use in worldwide telematics applications which require best in class LTE performance.

This unique product, only 30mm high, delivers powerful worldwide 4G LTE MIMO antenna technology at 700/800/900/1700/1800M/1900M/2600MHz.

Typical applications

- HD Video over LTE
- First Responder and Emergency Services
- Intelligent Transport Systems
- Internet of Things (IoT market)
- High Definition Video Broadcast Systems
- Wireless LTE MIMO M2M Devices
- Digital Signage

LTE 4G applications demand high speed data uplink and downlink. High efficiency and high gain MIMO antennas are necessary to achieve the required signal to noise ratio and throughput required to solve these challenges. Taoglas also takes care to have high isolation between the two MIMO antennas to prevent self-interference. The MA412 does not require a ground plane. Low loss cables are used to keep efficiency high over long cable lengths. In contrast, smaller MIMO antennas with poorer quality thinner cables will have much reduced efficiency and isolation, which would lead to a large drop in system throughput or drops, and may indeed not make a system connection at all.

We have a version with SMA(M) also as standard MA412.A.BI.003. Cable length and connector types are customizable. Conformity is declared under the following standard:

Conformity is declared under the following standard: **EN55022 Class B**. This is to declare that the product listed above conform to the EMC directive 2014/30/EU.

## 2. Specification

4G/3G/2G MIMO1 Antenna									
Frequency (MHz)		LTE700	GSM850	GSM900	DCS	PCS	UMTS1	LTE2600	LTE3500
		698~803	824~894	880~960	1710~1880	1850~1990	1920~2170	2490~2690	3300~3600
Efficiency (%)									
On the 50*50cm ground plane	30cm	62.06	41.76	49.16	44.93	59.56	59.39	55.42	37.39
	1M	59.27	39.88	46.95	40.98	54.46	54.71	50.55	33.33
	2M	55.31	36.93	42.81	36.86	48.53	48.56	43.53	27.99
	3M	51.62	34.20	39.76	32.65	42.73	42.47	36.84	23.59
	5M	44.25	28.85	33.36	25.50	32.98	32.90	28.22	16.96
In free space	30cm	65.08	48.08	55.44	49.41	57.62	59.92	54.98	38.19
	1M	62.15	45.91	52.95	45.06	52.69	55.18	50.14	34.83
	2M	58.00	42.54	48.29	40.62	46.96	48.99	43.17	29.65
	3M	54.13	39.46	44.80	35.92	41.31	42.84	36.53	24.66
	5M	46.39	33.24	37.60	28.10	31.89	33.19	27.99	19.14
Average Gain(dBi)									
On the 50*50cm ground plane	30cm	-2.22	-3.98	-3.20	-3.55	-2.27	-2.27	-2.57	-4.36
	1M	-2.42	-4.18	-3.40	-3.95	-2.66	-2.63	-2.97	-4.86
	2M	-2.72	-4.51	-3.80	-4.40	-3.16	-3.14	-3.62	-5.61
	3M	-3.02	-4.84	-4.13	-4.94	-3.72	-3.73	-4.35	-6.36
	5M	-3.70	-5.58	-4.88	-6.00	-4.84	-4.84	-5.50	-7.79
In free space	30cm	-2.02	-3.19	-2.60	-3.11	-2.42	-2.23	-2.62	-4.25
	1M	-2.22	-3.39	-2.80	-3.51	-2.81	-2.59	-3.02	-4.65
	2M	-2.52	-3.72	-3.20	-3.97	-3.31	-3.10	-3.67	-5.35
	3M	-2.82	-4.05	-3.52	-4.50	-3.86	-3.69	-4.39	-6.15
	5M	-3.50	-4.79	-4.28	-5.57	-4.98	-4.80	-5.55	-7.25
Peak Gain(dBi)									
On the 50*50cm ground plane	30cm	5.37	3.66	4.35	6.24	7.04	7.11	7.91	6.46
	1M	5.17	3.46	4.15	5.84	6.64	6.81	7.51	5.96
	2M	4.87	3.06	3.75	5.34	6.14	6.31	6.91	5.16
	3M	4.57	2.76	3.45	4.84	5.64	5.71	6.21	4.46
	5M	3.87	2.06	2.65	3.74	4.44	4.61	5.11	4.82
In free space	30cm	3.54	4.07	4.13	4.67	6.57	6.69	8.11	6.27
	1M	3.34	3.87	3.93	4.27	6.17	6.35	7.71	5.87
	2M	3.04	3.47	3.53	3.77	5.67	5.79	7.11	5.17
	3M	2.74	3.17	3.23	3.27	5.07	5.19	6.41	4.37
	5M	2.04	2.37	2.43	2.17	3.97	4.09	5.31	3.27

4G/3G/2G MIMO2 Antenna									
Frequency (MHz)	LTE700	GSM850	GSM900	DCS	PCS	UMTS1	LTE2600	LTE3500	
	698~803	824~894	880~960	1710~1880	1850~1990	1920~2170	2490~2690	3300~3600	
Efficiency (%)									
On the 50*50cm ground plane	30cm	64.02	46.23	45.95	66.28	61.93	55.94	67.23	32.20
	1M	61.13	44.15	43.91	60.45	56.58	51.48	61.32	28.70
	2M	57.05	40.91	40.05	54.37	50.43	45.69	52.80	24.24
	3M	53.25	37.91	37.20	48.10	44.46	39.97	44.69	20.32
	5M	45.57	31.95	31.19	37.61	34.31	30.95	34.23	14.73
In free space	30cm	55.35	40.93	43.23	62.98	59.12	53.24	67.13	31.79
	1M	52.86	39.09	41.29	57.44	54.01	49.00	61.23	28.99
	2M	49.33	36.19	37.65	51.67	48.14	43.49	52.73	24.68
	3M	46.04	33.55	34.96	45.71	42.45	38.04	44.63	20.53
	5M	39.41	28.29	29.34	35.75	32.75	29.46	34.18	15.93
Average Gain(dBi)									
On the 50*50cm ground plane	30cm	-2.17	-3.38	-3.48	-1.84	-2.17	-2.57	-1.73	-5.25
	1M	-2.37	-3.58	-3.68	-2.24	-2.56	-2.93	-2.13	-5.75
	2M	-2.67	-3.91	-4.08	-2.69	-3.06	-3.44	-2.78	-6.50
	3M	-2.97	-4.23	-4.41	-3.23	-3.62	-4.03	-3.50	-7.25
	5M	-3.64	-4.98	-5.17	-4.29	-4.74	-5.14	-4.66	-8.68
In free space	30cm	-2.87	-3.93	-3.71	-2.04	-2.39	-2.80	-1.73	-5.28
	1M	-3.07	-4.13	-3.91	-2.44	-2.78	-3.16	-2.13	-5.68
	2M	-3.37	-4.46	-4.31	-2.90	-3.28	-3.67	-2.78	-6.38
	3M	-3.67	-4.79	-4.63	-3.43	-3.84	-4.26	-3.51	-7.18
	5M	-4.35	-5.53	-5.39	-4.50	-4.96	-5.37	-4.67	-8.28
Peak Gain(dBi)									
On the 50*50cm ground plane	30cm	6.51	4.09	3.82	7.93	8.06	7.89	8.16	5.48
	1M	6.31	3.89	3.62	7.53	7.66	7.49	7.76	4.98
	2M	6.01	3.59	3.22	7.03	7.16	6.99	7.16	4.28
	3M	5.71	3.19	2.92	6.53	6.66	6.49	6.46	3.48
	5M	5.01	2.49	2.22	5.43	5.46	5.29	5.36	2.18
In free space	30cm	5.21	2.85	3.16	7.48	7.48	7.29	8.13	5.37
	1M	5.01	2.65	2.96	7.08	7.08	6.89	7.73	4.97
	2M	4.71	2.25	2.56	6.58	6.58	6.39	7.13	4.27
	3M	4.41	1.95	2.26	6.08	6.08	5.88	6.43	3.47
	5M	3.71	1.15	1.46	4.98	4.98	4.69	5.33	2.37

ELECTRICAL	
Impedance	50Ω
Polarization	Linear
VSWR	< 3.5
Cable	0.3 meter CFD200 standard, fully customizable
Connector	Fakra(Jack) standard connector , fully customizable
MECHANICAL	
Antenna Dimensions	216.24*93.25*30.95mm
Casing	ABS+PC
Base and thread	Nickel Plated Aluminum
Weight	400g
Ingress Protection Rating	IP67
Maximum Assembly Torque	39.2 N-m
ENVIRONMENTAL	
Operation Temperature	-40°C to 85°C
Storage Temperature	-40°C to 90°C
Humidity	Non-condensing 65°C 95% RH

LTE BANDS				
Band Number	LTE / LTE-Advanced / WCDMA / HSPA / HSPA+ / TD-SCDMA			
	Uplink	Downlink	Covered	Covered
1	UL: 1920 to 1980	DL: 2110 to 2170	✓	✓
2	UL: 1850 to 1910	DL: 1930 to 1990	✓	✓
3	UL: 1710 to 1785	DL: 1805 to 1880	✓	✓
4	UL: 1710 to 1755	DL: 2110 to 2155	✓	✓
5	UL: 824 to 849	DL: 869 to 894	✓	✓
7	UL: 2500 to 2570	DL: 2620 to 2690	✓	✓
8	UL: 880 to 915	DL: 925 to 960	✓	✓
9	UL: 1749.9 to 1784.9	DL: 1844.9 to 1879.9	✓	✓
11	UL: 1427.9 to 1447.9	DL: 1475.9 to 1495.9	✗	✗
12	UL: 699 to 716	DL: 729 to 746	✓	✓
13	UL: 777 to 787	DL: 746 to 756	✓	✓
14	UL: 788 to 798	DL: 758 to 768	✓	✓
17	UL: 704 to 716	DL: 734 to 746 (LTE only)	✓	✓
18	UL: 815 to 830	DL: 860 to 875 (LET only)	✓	✓
19	UL: 830 to 845	DL: 875 to 890	✓	✓
20	UL: 832 to 862	DL: 791 to 821	✓	✓
21	UL: 1447.9 to 1462.9	DL: 1495.9 to 1510.9	✗	✗
22	UL: 3410 to 3490	DL: 3510 to 3590	✓	✗
23	UL: 2000 to 2020	DL: 2180 to 2200 (LTE only)	✓	✓
24	UL: 1625.5 to 1660.5	DL: 1525 to 1559 (LTE only)	✗	✗
25	UL: 1850 to 1915	DL: 1930 to 1995	✓	✓
26	UL: 814 to 849	DL: 859 to 894	✓	✓
27	UL: 807 to 824	DL: 852 to 869 (LTE only)	✓	✓
28	UL: 703 to 748	DL: 758 to 803 (LTE only)	✓	✓
29	UL: -	DL: 717 to 728 (LTE only)	✓	✓
30	UL: 2305 to 2315	DL: 2350 to 2360 (LTE only)	✓	✓
31	UL: 452.5 to 457.5	DL: 462.5 to 467.5 (LTE only)	✗	✗
32	UL: -	DL: 1452 - 1496	✗	✗
35		1850 to 1910	✓	✓
38		2570 to 2620	✓	✓
39		1880 to 1920	✓	✓
40		2300 to 2400	✓	✓
41		2496 to 2690	✓	✓
42		3400 to 3600	✓	✗
43		3600 to 3800	✓	✓

\*Covered bands represent an efficiency greater than 20%

## 3. Antenna Characteristics

### 3.1. LTE MIMO Antenna

#### 3.1.1. Test Setup

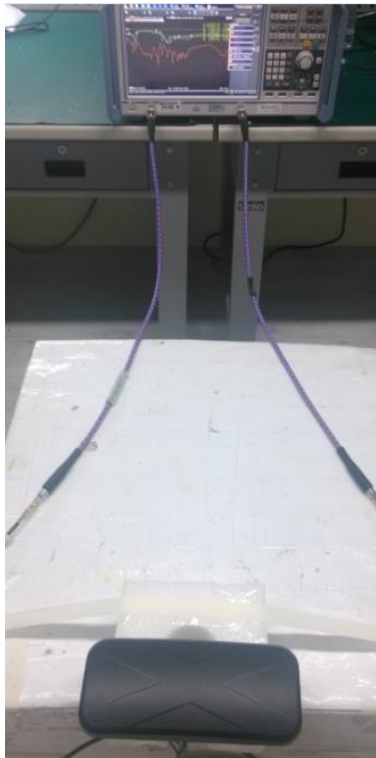

In free space

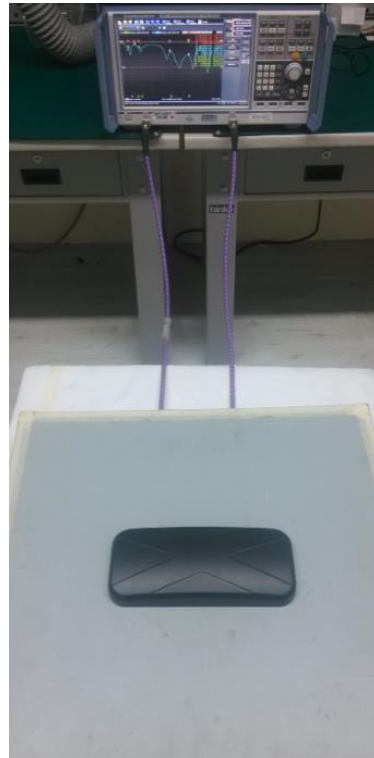

on the 50\*50cm ground plane



### 3.1.2. LTE Antenna Return Loss

Setup on the 50\*50cm ground plane with 0.3 meter cable length

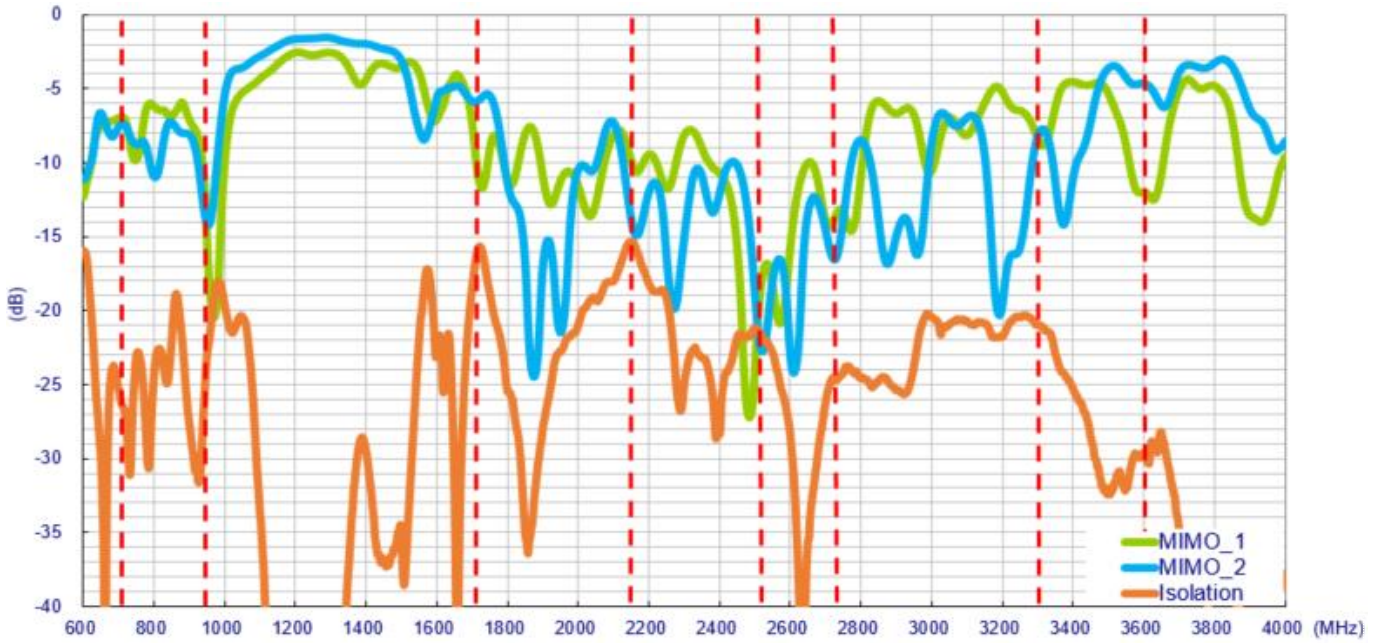

Setup in free space with 0.3 meter cable length

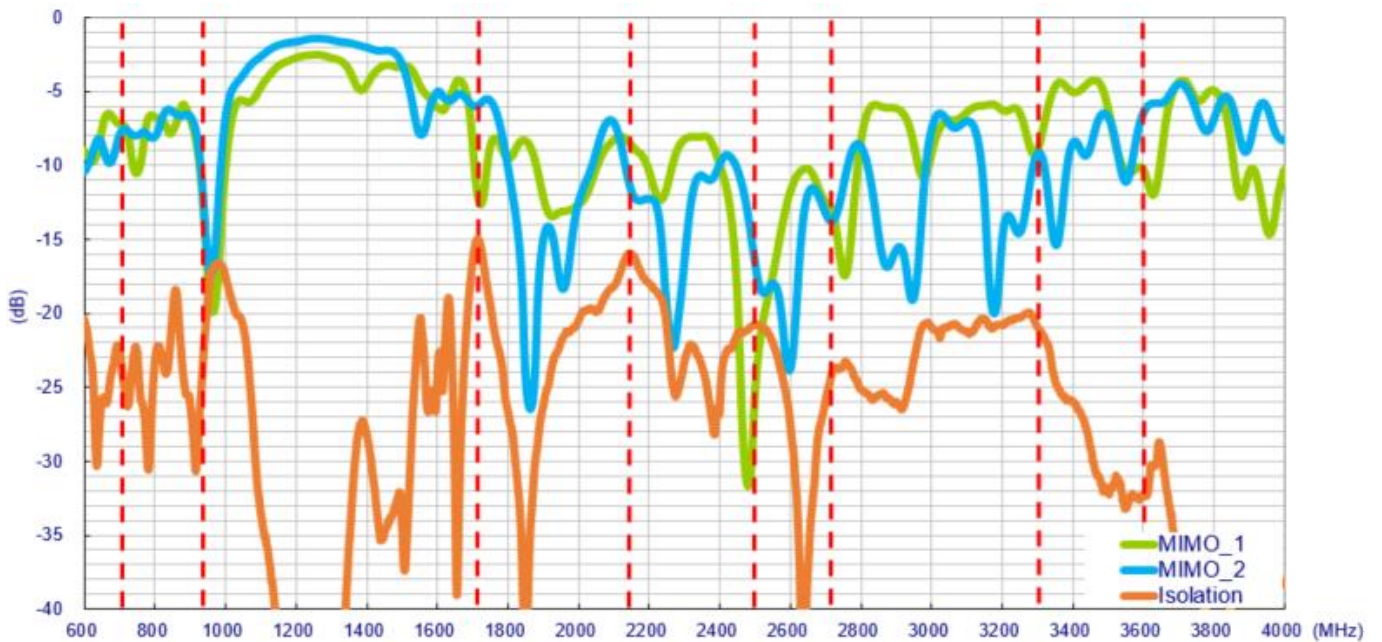



### 3.1.3. LTE Antenna Efficiency

Setup on the 50\*50cm ground plane with 0.3 meter cable length

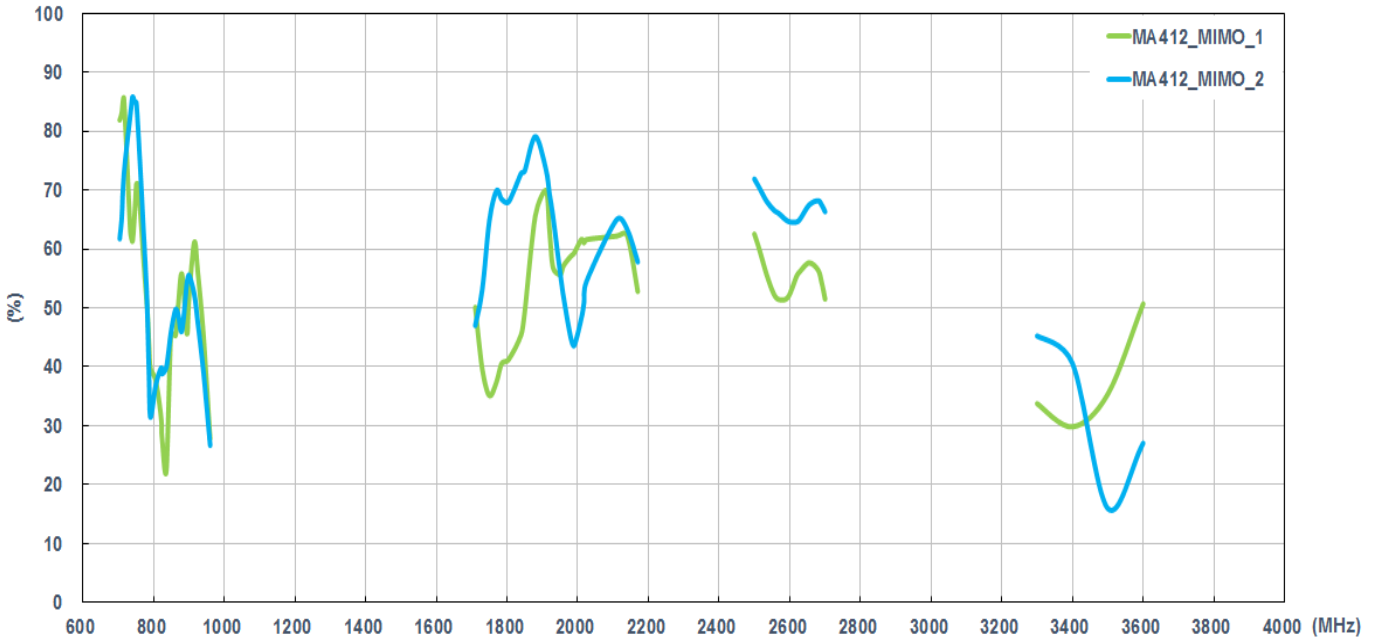

Setup in free space with 0.3 meter cable length

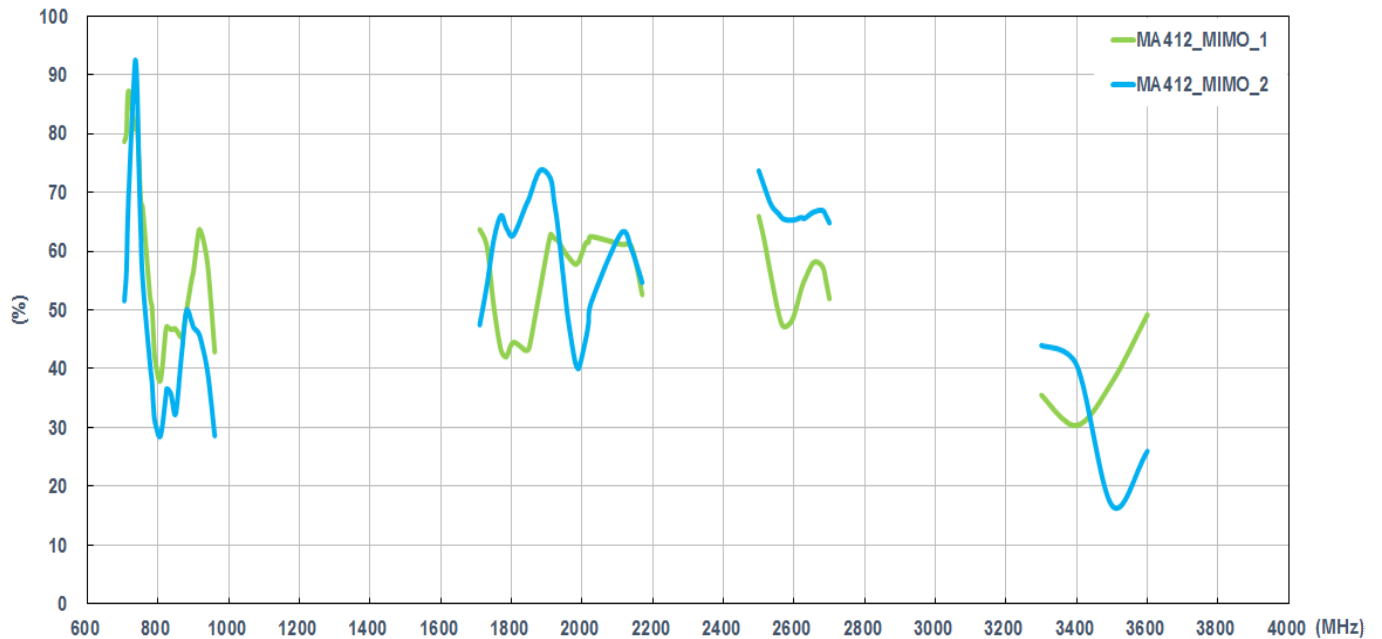

### 3.1.4. LTE Antenna Peak Gain

Setup on the 50\*50cm ground plane with 0.3 meter cable length

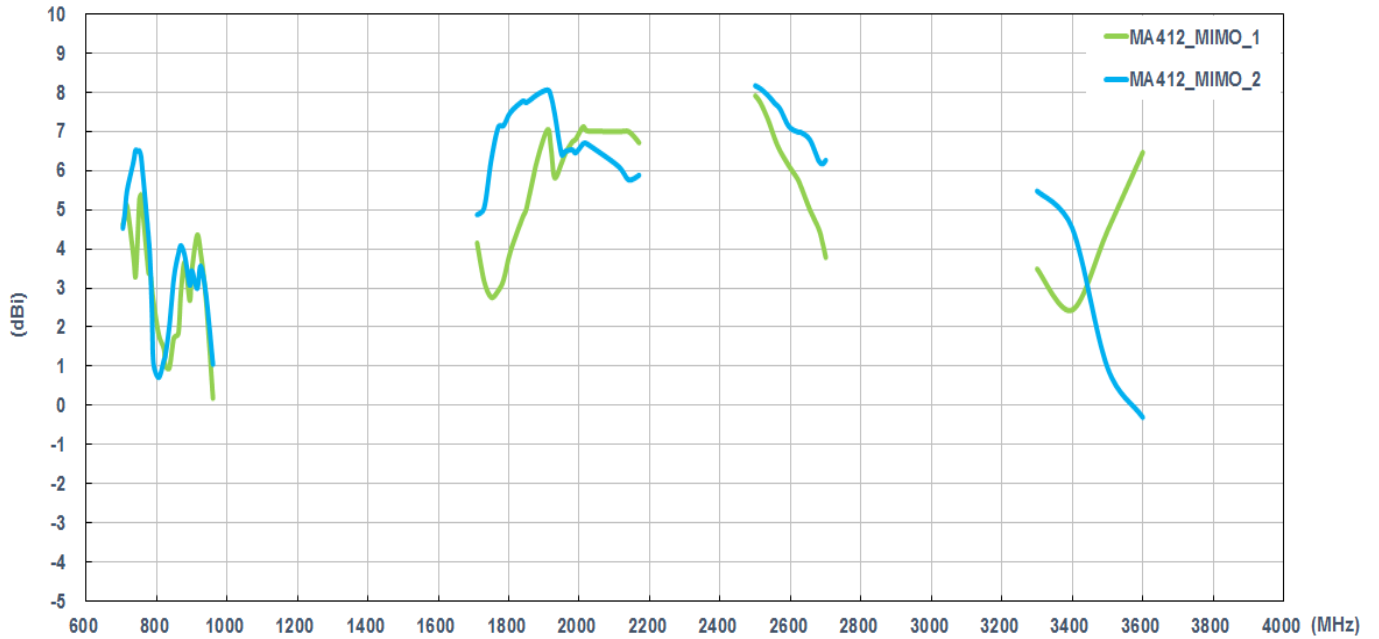

Setup in free space with 0.3 meter cable length

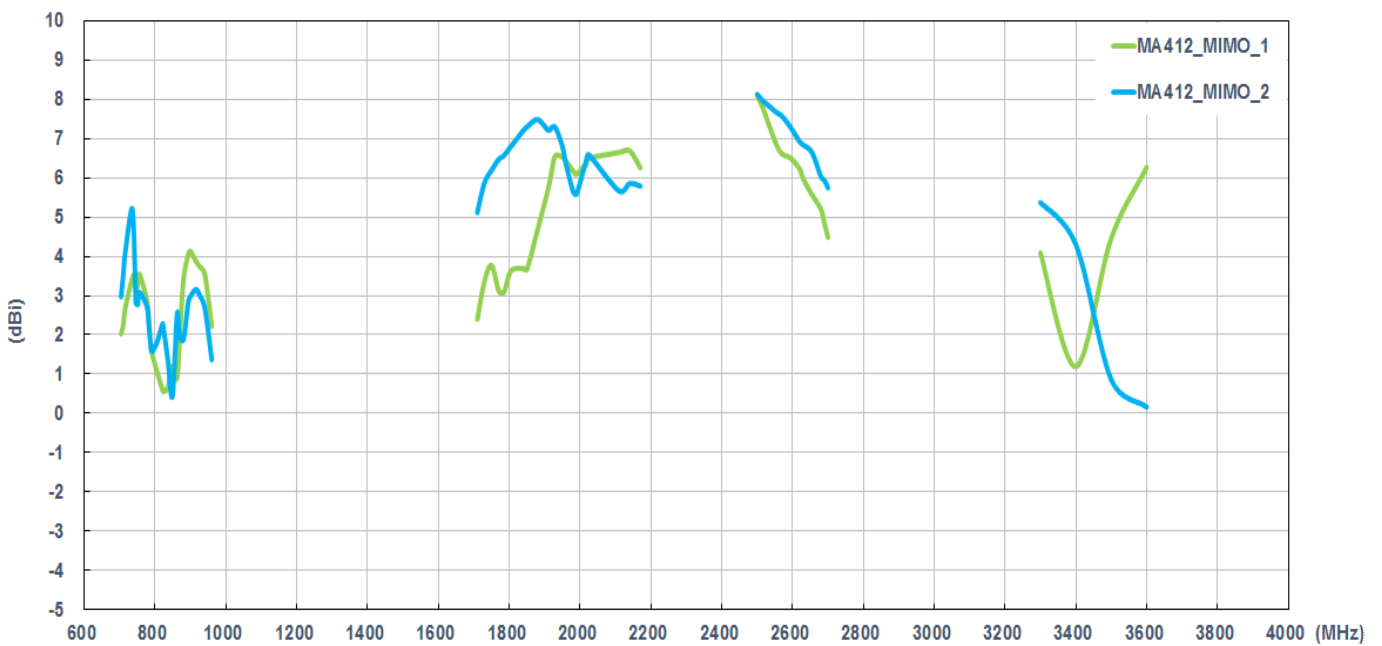

### 3.1.5. LTE Antenna Average gain

Setup on the 50\*50cm ground plane with 0.3 meter cable length

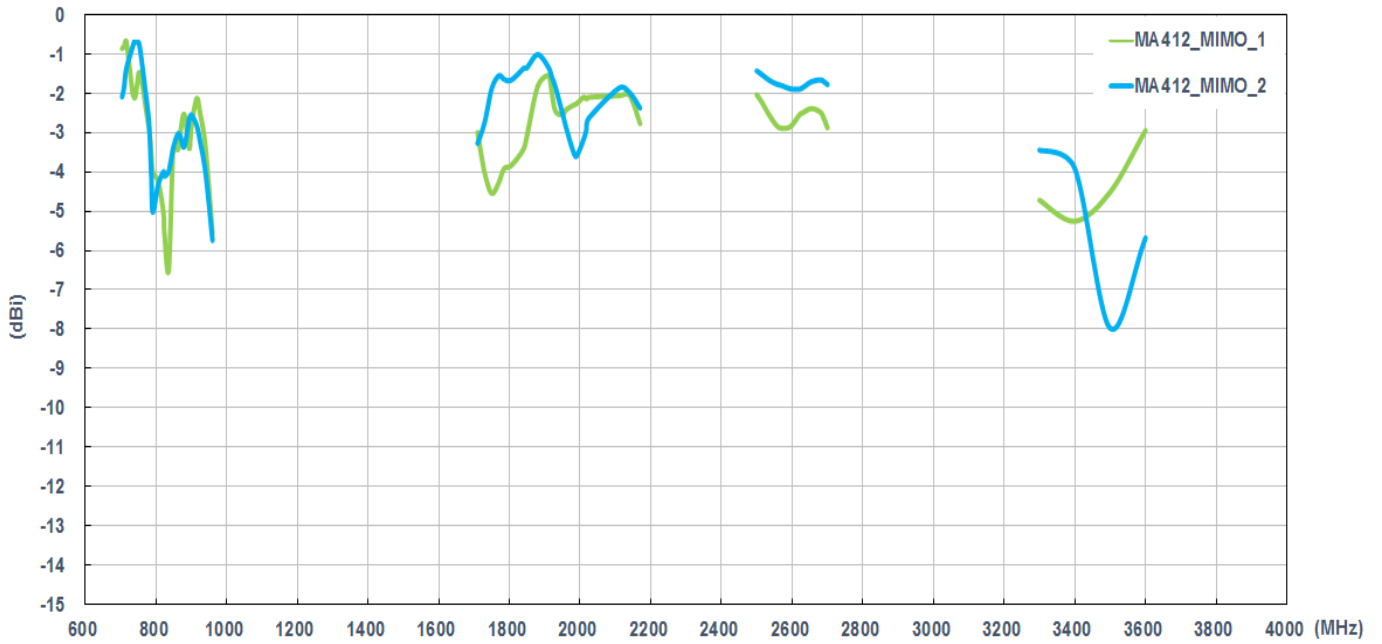

Setup in free space with 0.3 meter cable length

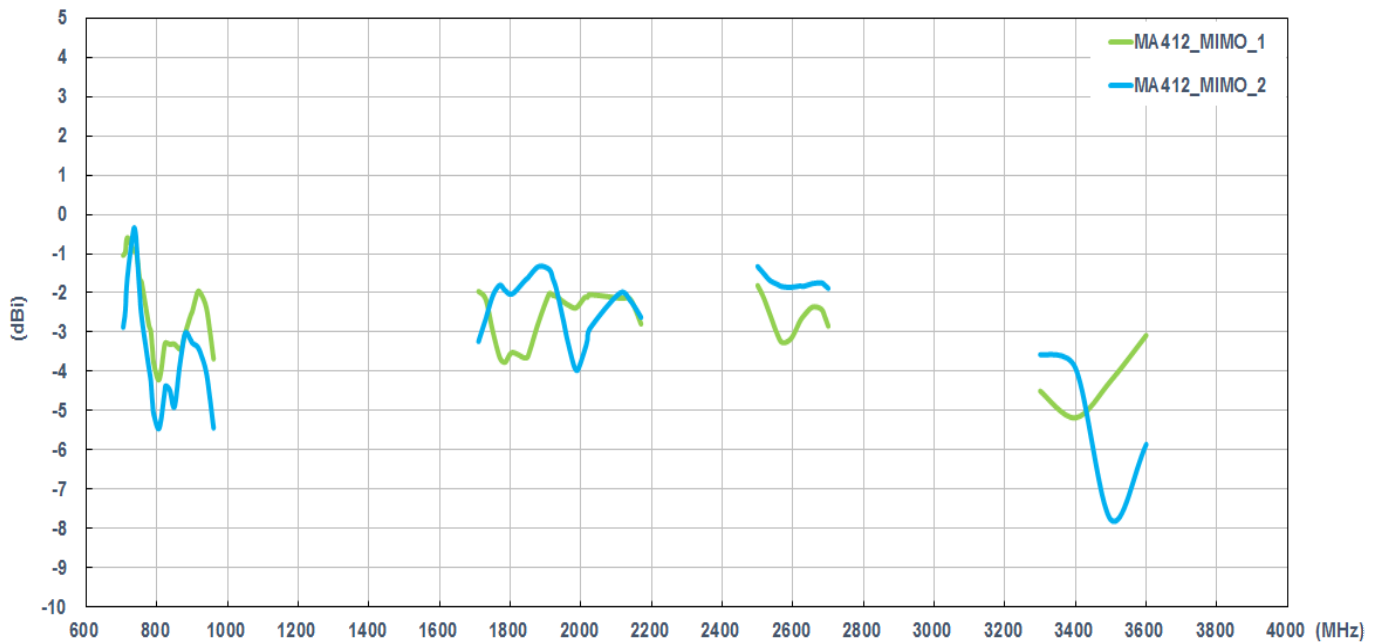

### 3.1.6. Test Setup For Antenna Radiation Pattern (ETS Anechoic chamber)

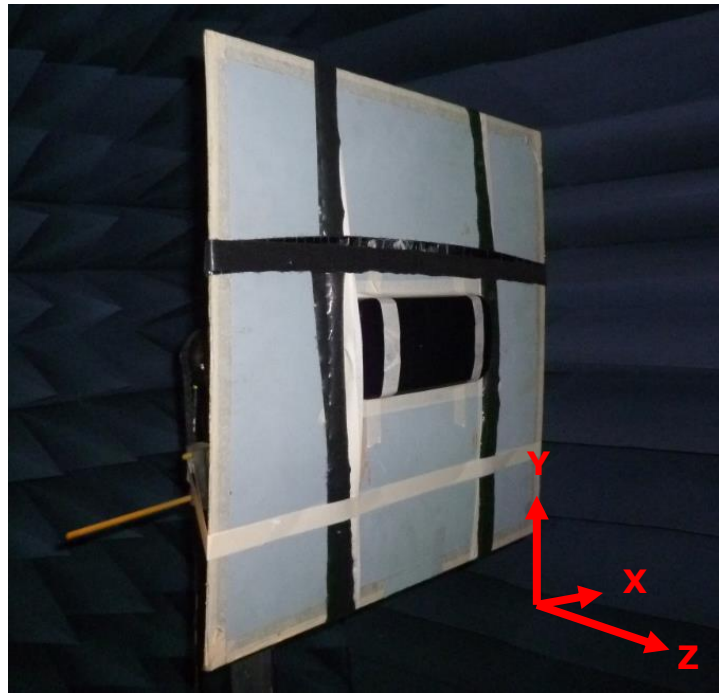

On the 50\*50cm ground plane

### 3.1.7. 2D Radiation pattern (MIMO1 with 0.3M cable length on the 50\*50 ground plane)

XY Plane

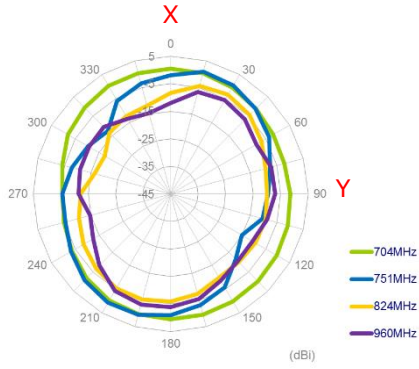

XZ Plane

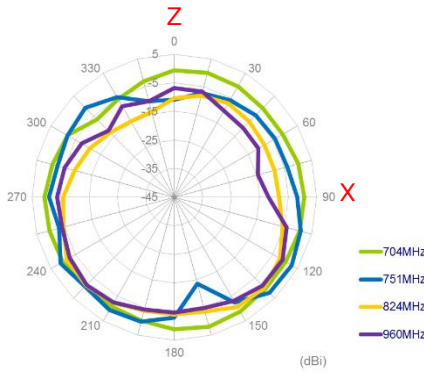

YZ Plane

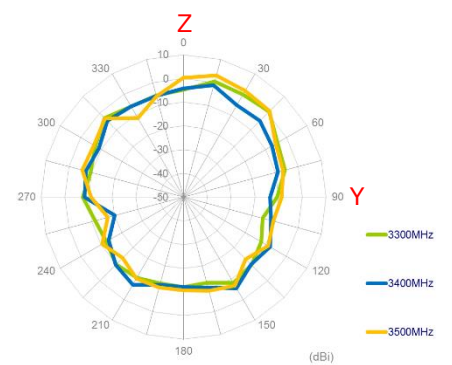
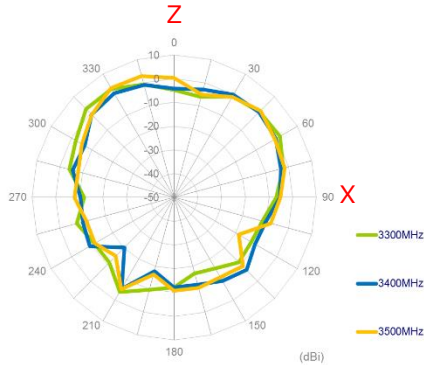
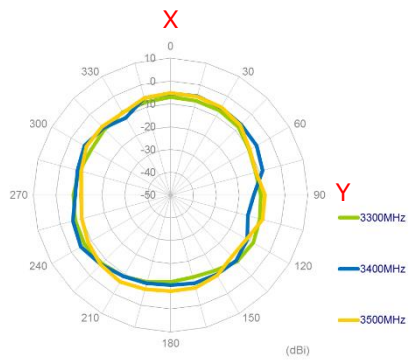
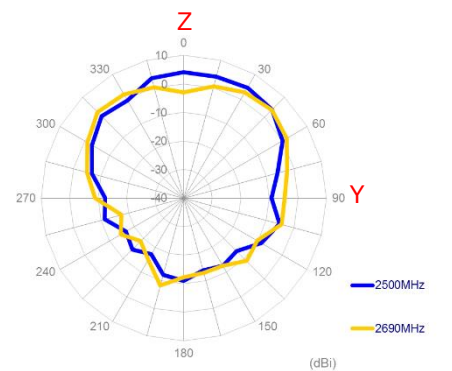
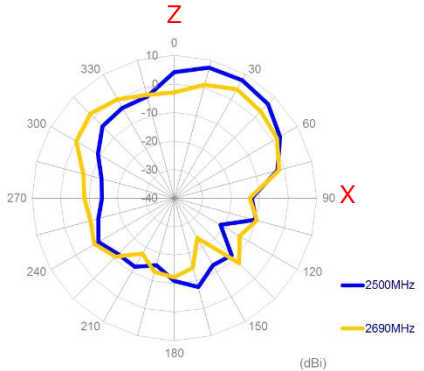
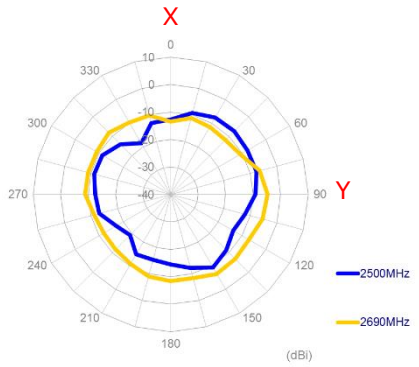
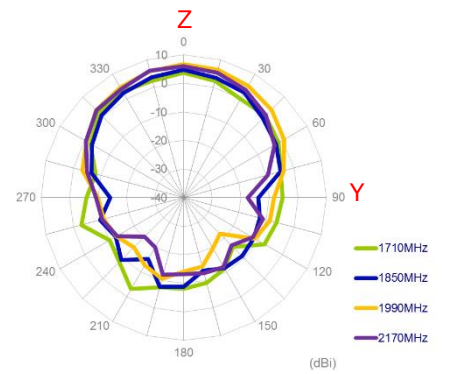
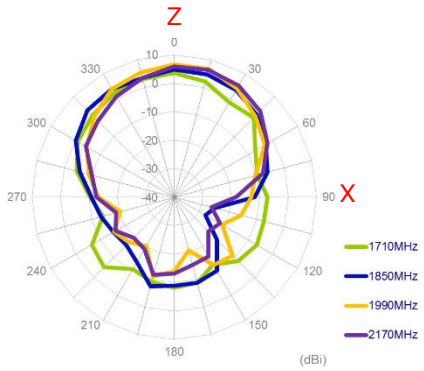
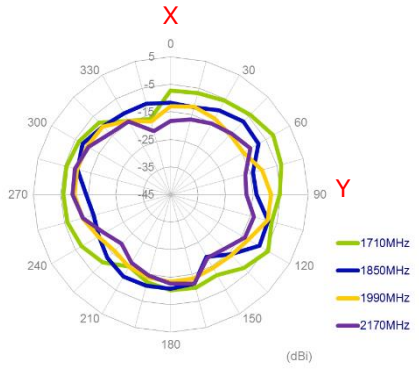
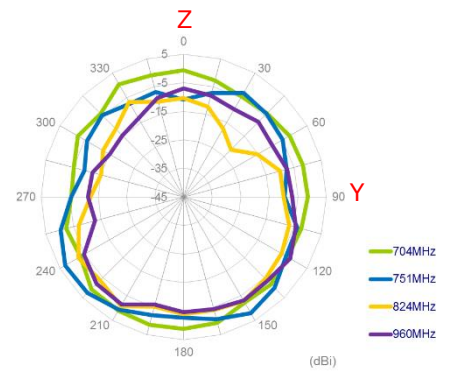

### 3.1.8. 3D Radiation pattern (MIMO1 with 0.3M cable length on the 50\*50 ground plane)

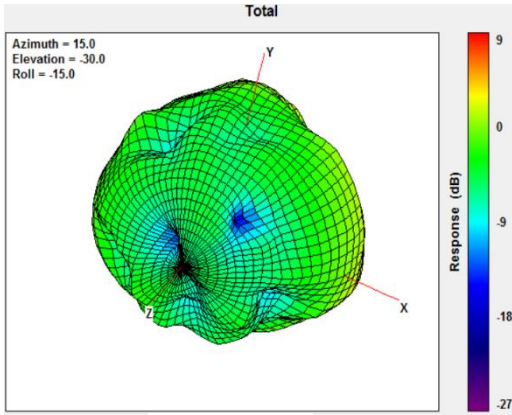

704MHz

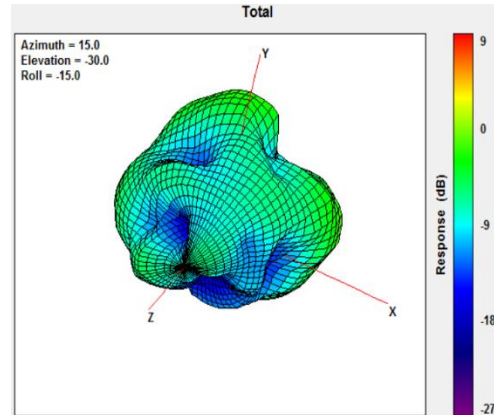

960MHz

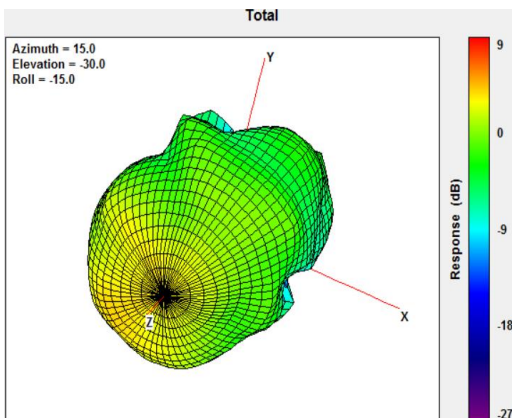

1710MHz

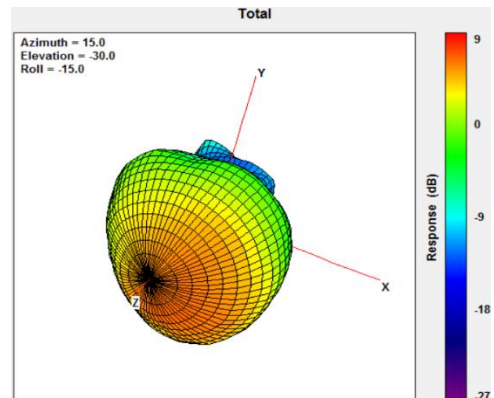

2170MHz

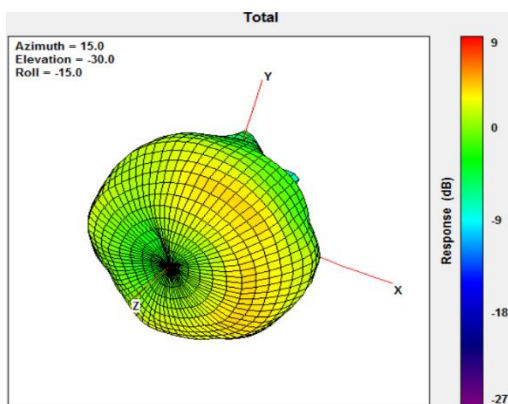

2690MHz

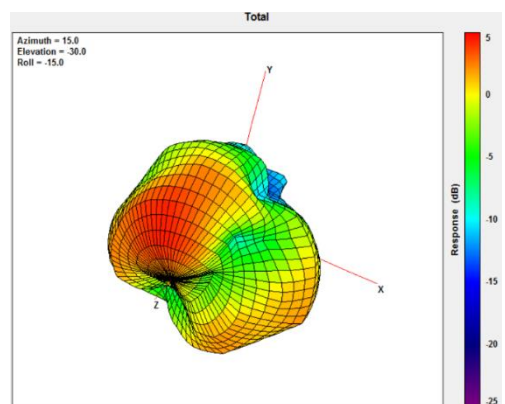

3500MHz



### 3.1.9. 2D Radiation pattern (MIMO2 with 0.3M cable length on the 50\*50 ground plane)

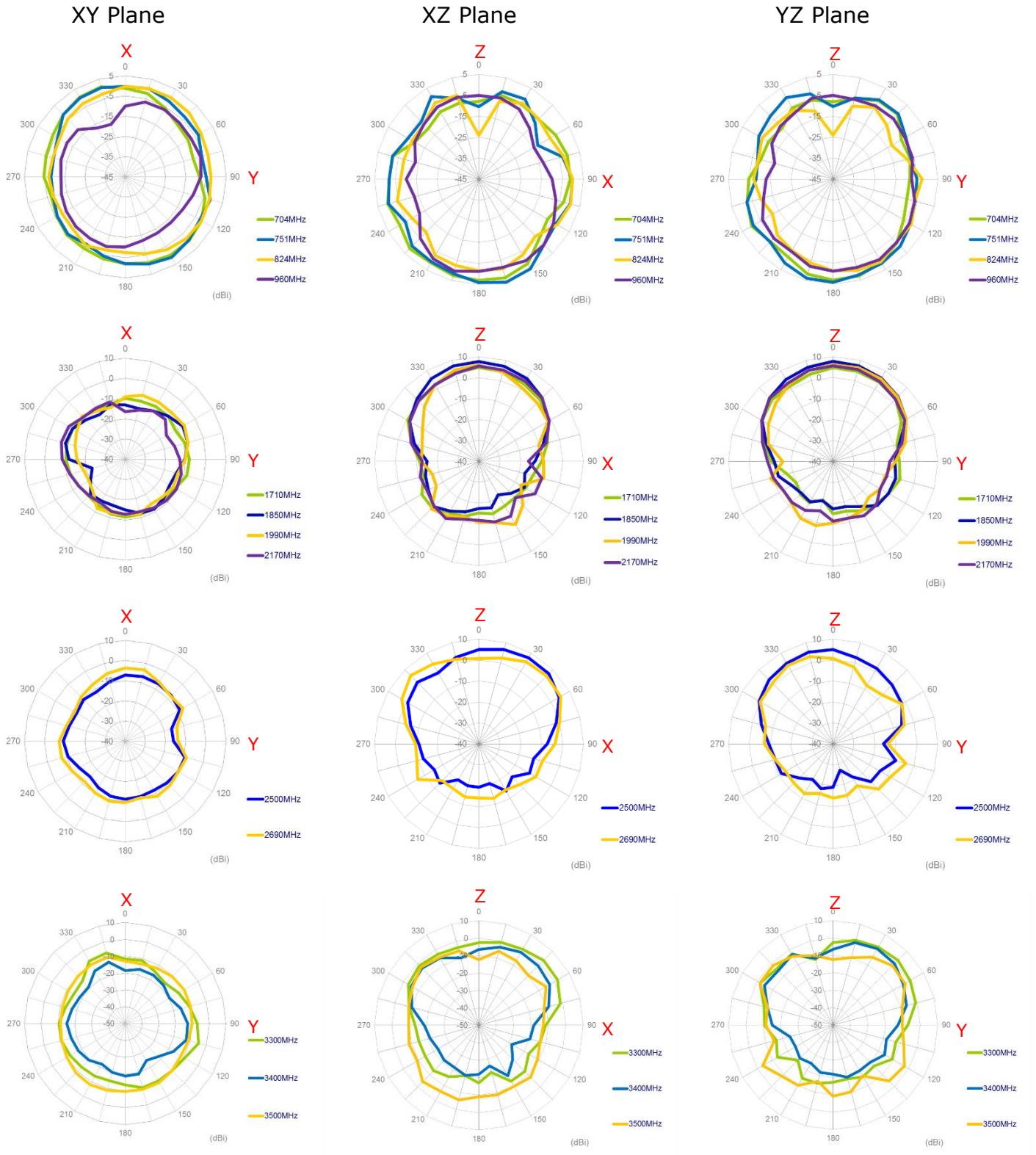



### 3.1.10. 3D Radiation pattern (MIMO2 with 0.3M cable length on the 50\*50 ground plane)

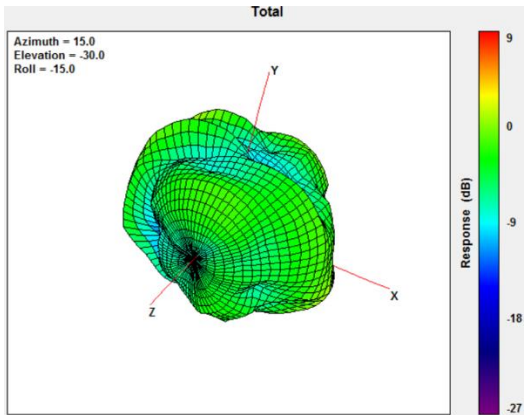

704MHz

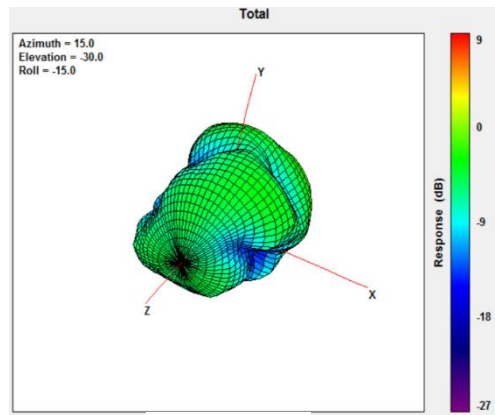

960MHz

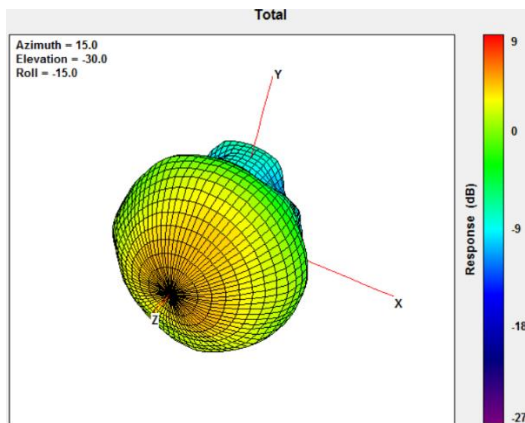

1710MHz

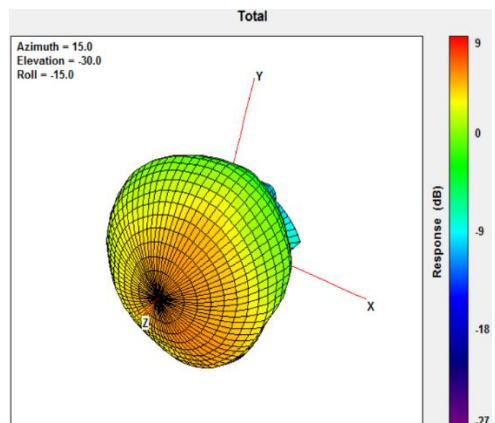

2170MHz

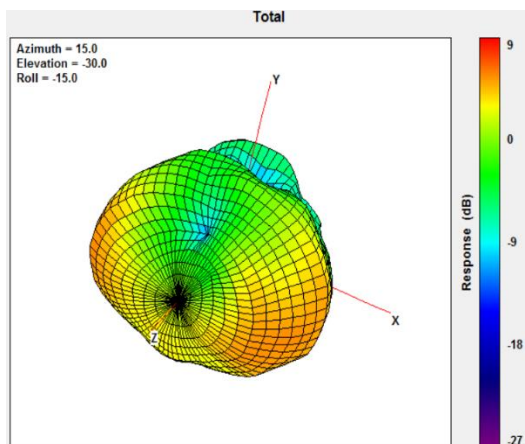

2690MHz

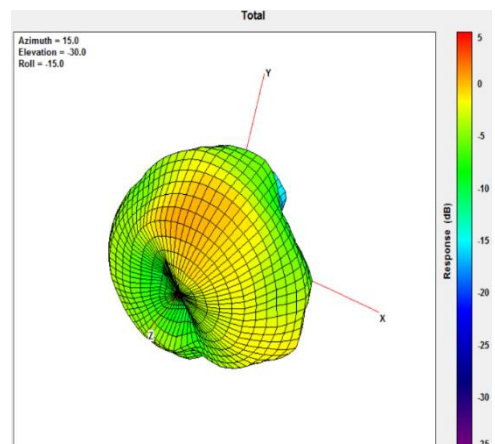

3500MHz

### 3.1.11. Test Setup for Antenna Radiation Pattern (ETS Anechoic chamber)

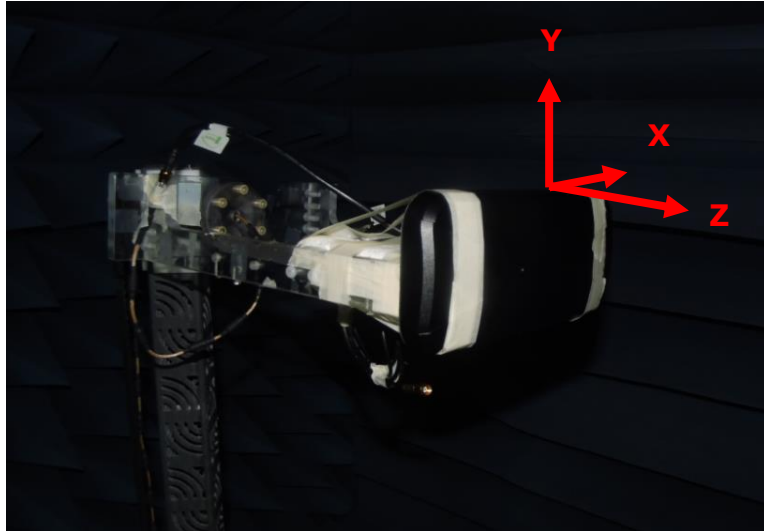

In free space

### 3.1.12. 2D Radiation pattern (MIMO1 with 0.3M cable length in free space)

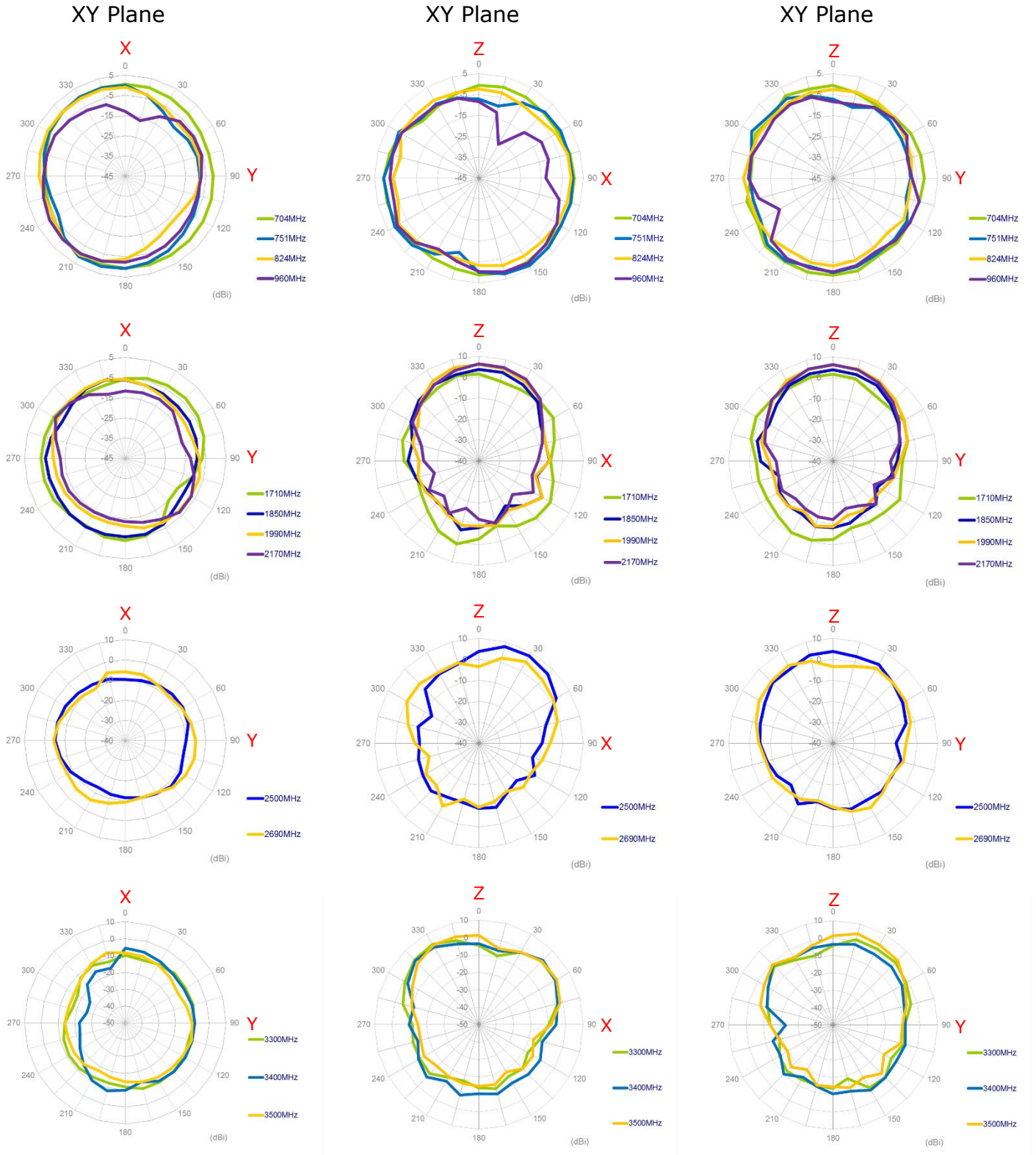

### 3.1.13. 3D Radiation pattern (MIMO1 with 0.3M cable length in free space)

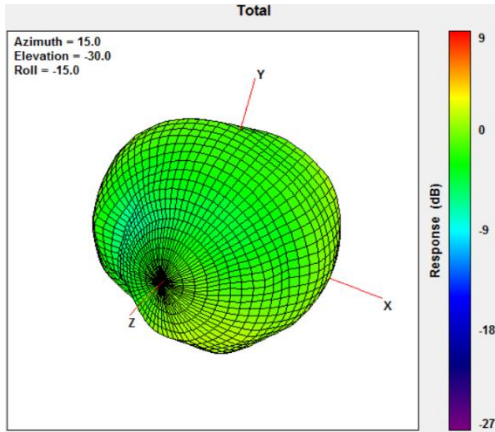

704MHz

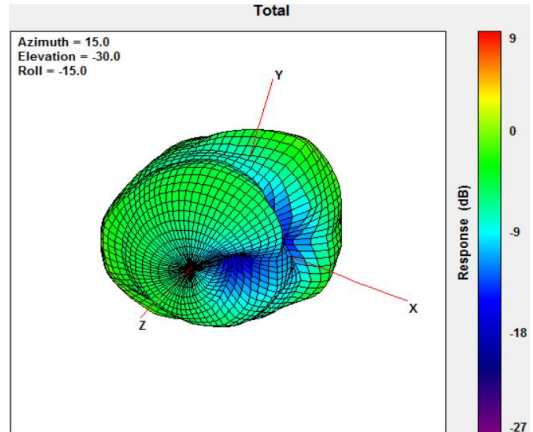

960MHz

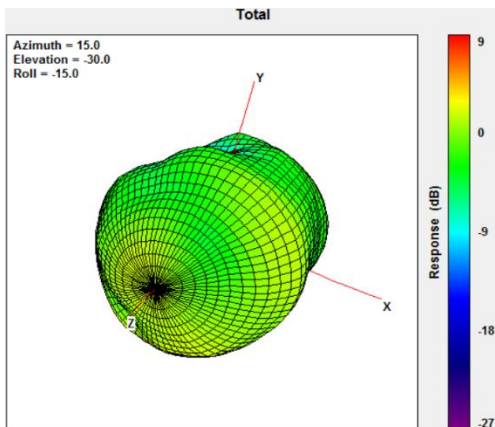

1710MHz

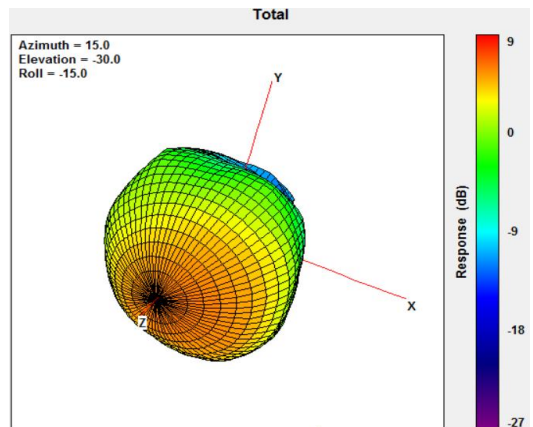

2170MHz

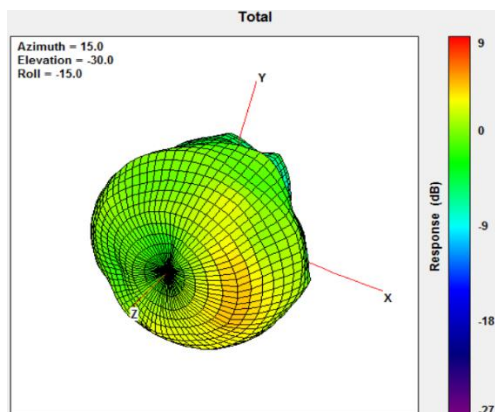

2690MHz

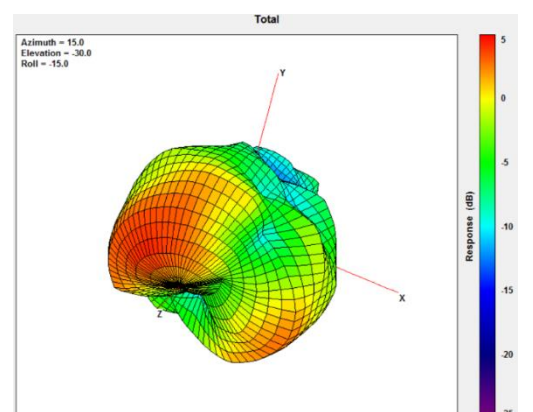

3500MHz



### 3.1.14. 2D Radiation pattern (MIMO2 with 0.3M cable length in free space)

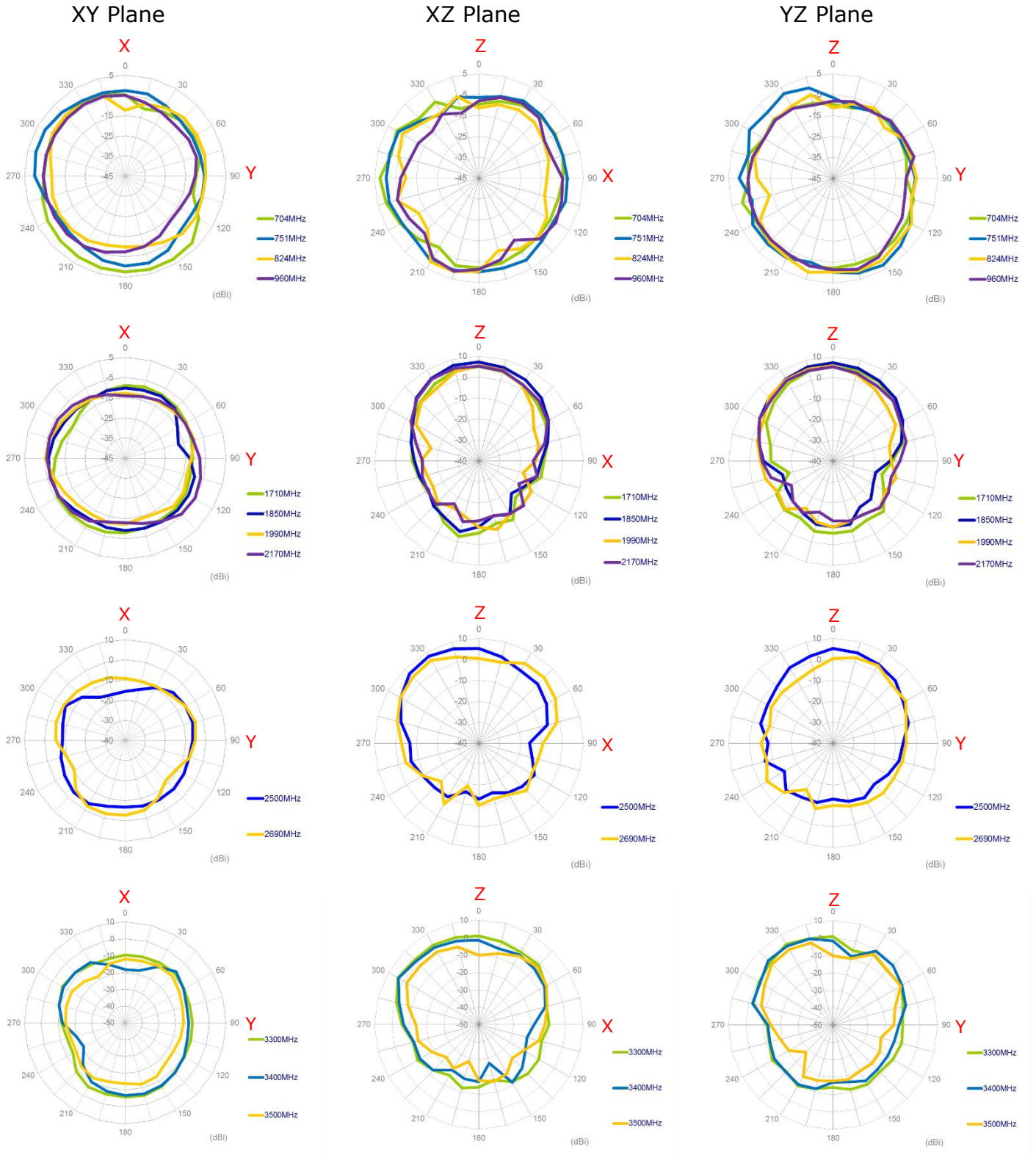

### 3.1.15. 3D Radiation pattern (MIMO2 with 0.3M cable length in free space)

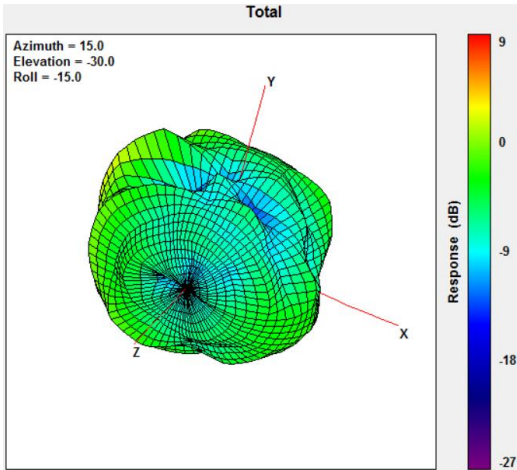

704MHz

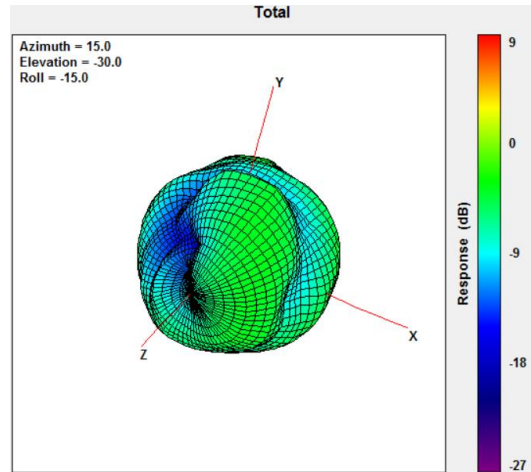

960MHz

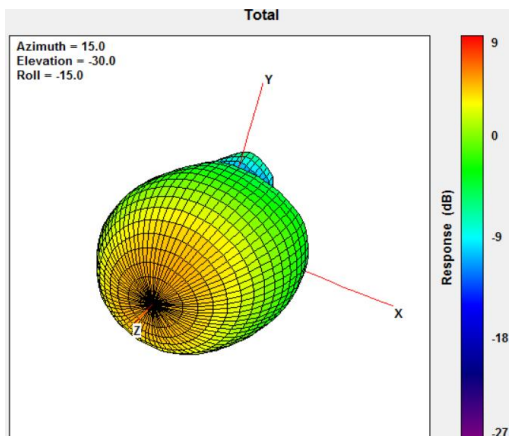

1710MHz

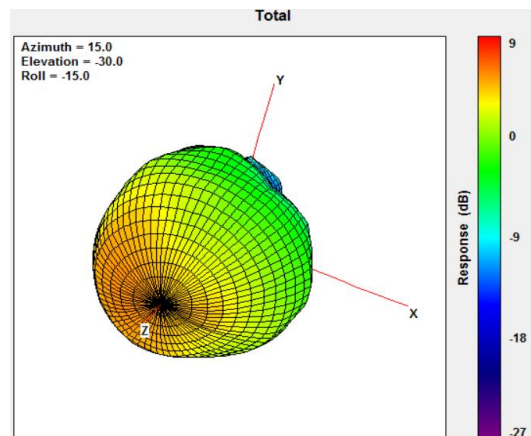

2170MHz

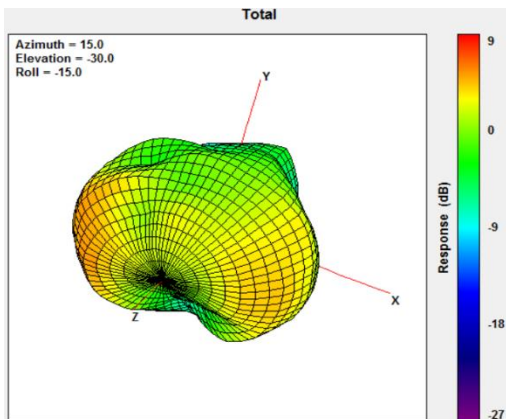

2690MHz

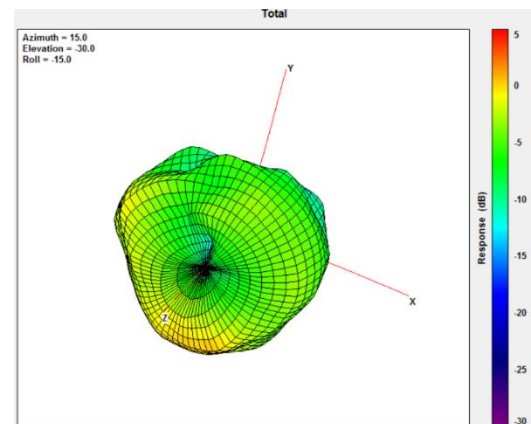

3500MHz

## 4. Mechanical Drawing (Units: mm)

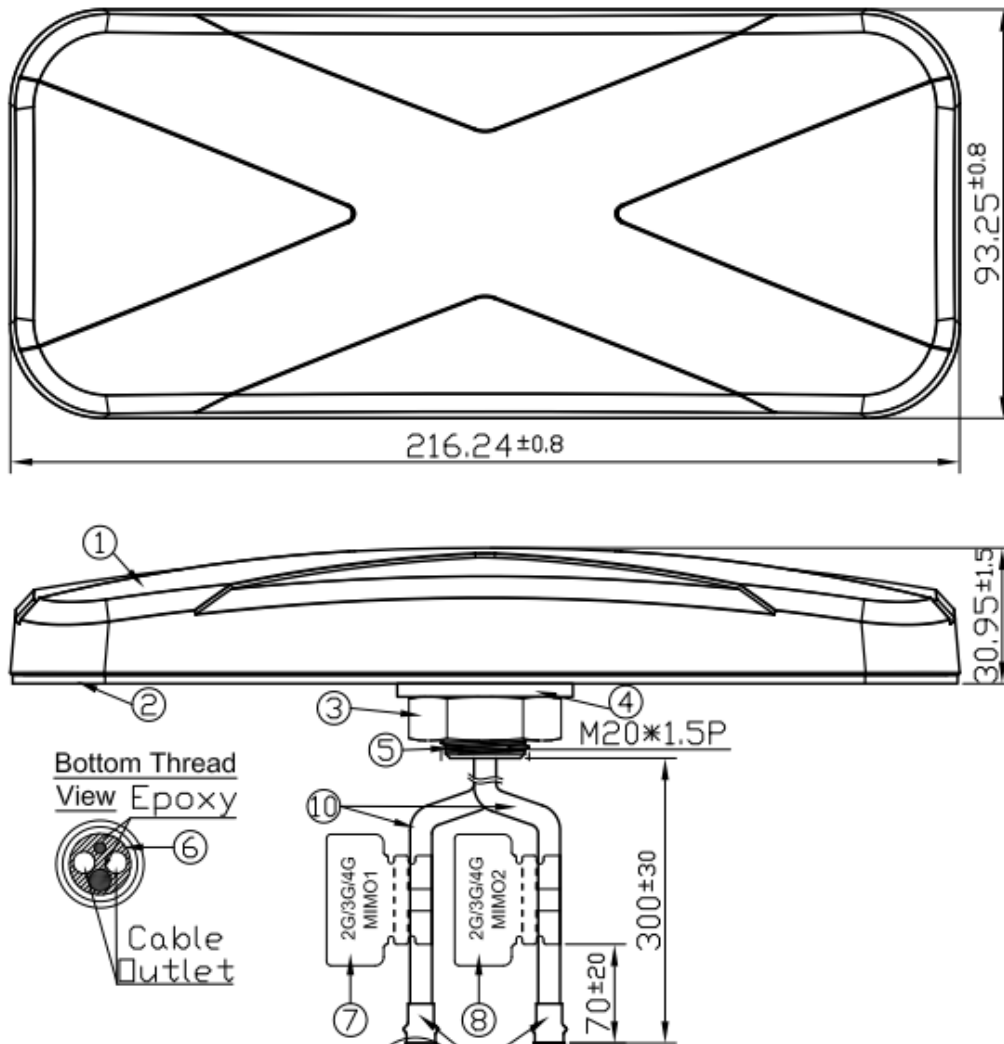

	Name	Material	Finish	
1	Housing	ABS & PC	Black	1
2	Closed Cell Foam and Adhesive Tape	3M 9448+CR-4305	Black	1
3	Nut_M20*1.5P*10H Cut	Steel	Ni Plated	1
4	Washer_Cut	Steel	Ni Plated	1
5	Metal Base	AL	Ni Plated	1
6	Cable Rubber	Silicone Rubber	Black	1
7	2G/3G/4G MIMO1 Label	Coated Paper	Grey	1
8	2G/3G/4G MIMO2 Label	Coated Paper	White	1
9	Heat Shrink Tube	PE	Black	2
10	CFD200 Coaxial Cable	PVC	Black	2
11	Fakra Code D Jack	PA66	Violet	2



### 4.1. Connector Drawing (Units mm)

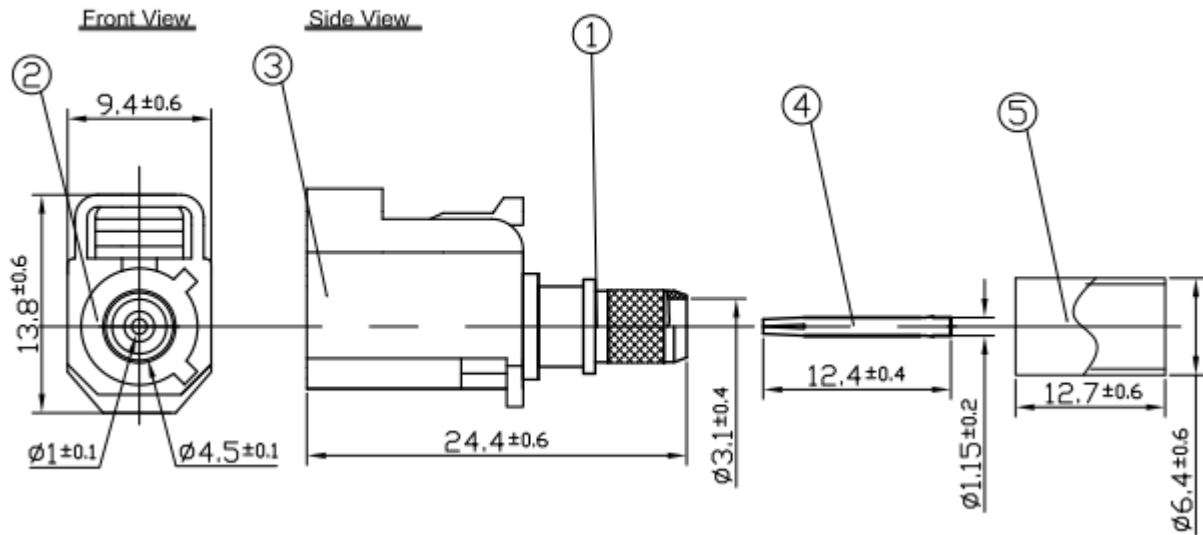

Detail "A"

	Name	Material	Finish	QTY
1	Body	Copper	Ni Plated	1
2	Insulator	Teflon	White	1
3	Shell	PA66	Violet	1
4	Female contact	P.B	Gold Plated	1
5	Ferrule	Copper	Ni Plated	1

## 5. Installation

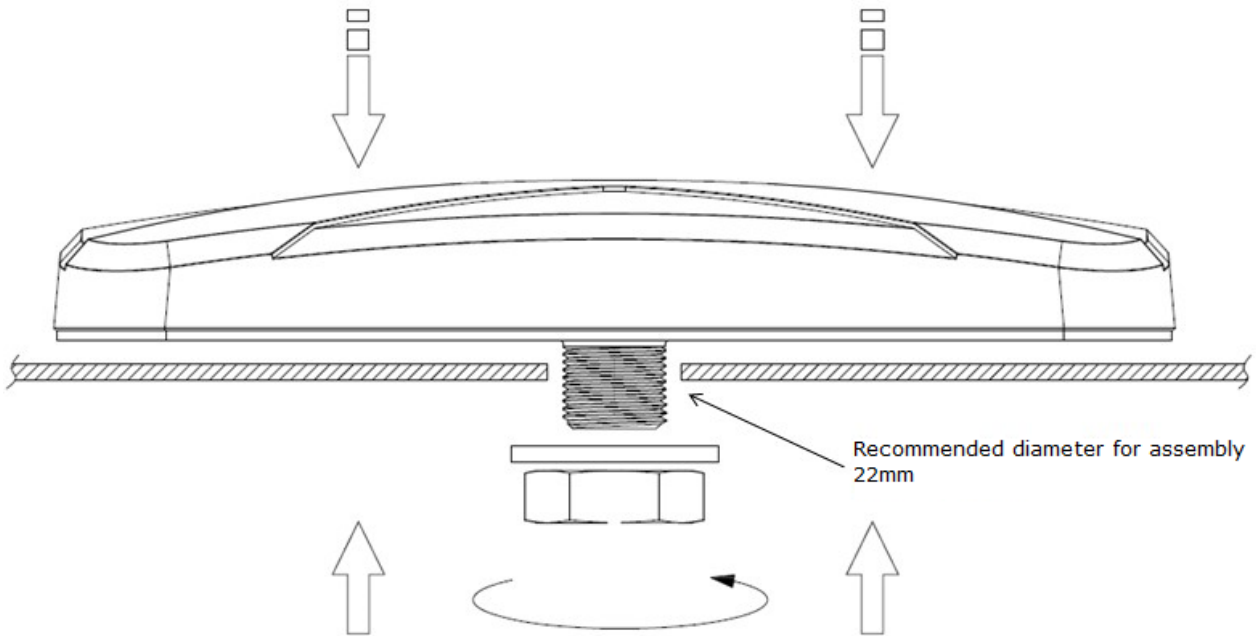

Recommended torque for mounting is 29.4 N.m  
Maximum torque for mounting is 39.2 N.m

## 6. Packaging

**MA412.A.BI.001**

### Packaging Specifications

1pc MA412.A.BI.001 per small box  
 Box Dimensions - 325x125x106mm  
 Weight - 630g

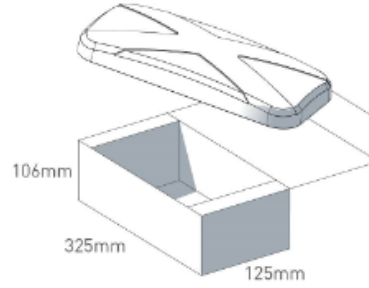

9 small boxes in one carton  
 Carton Dimensions - 360x360x400mm  
 Weight - 6.57Kg

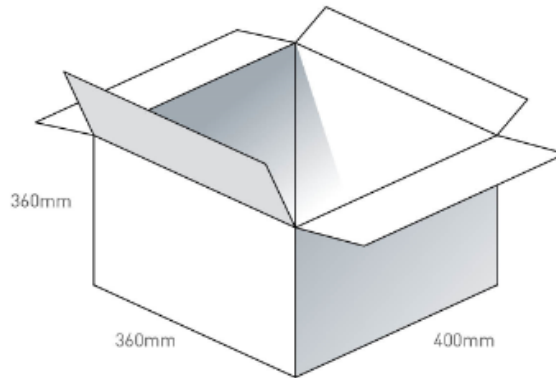

Pallet Dimensions 1080x720x1350mm  
 15 Cartons per Pallet  
 5 Cartons per layer  
 3 Layers

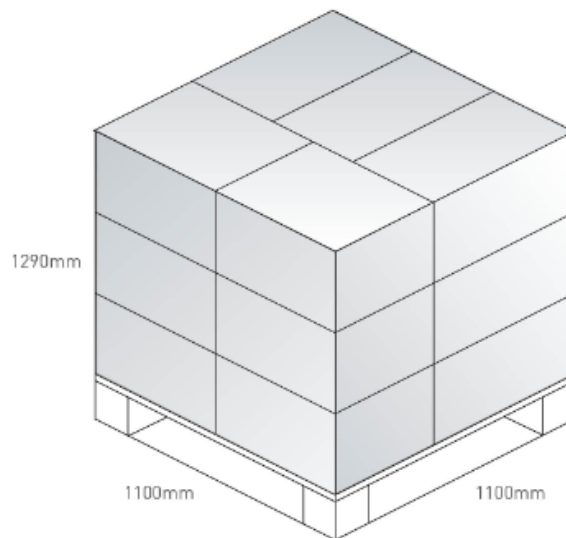

## 7. Application Note (LTE MIMO Antenna)

The MA412 antenna performance with different cable lengths and different environments is shown below.

### 7.1. On the 50\*50cm ground plane

#### 7.1.1. Return Loss (MIMO\_1 on the 50\*50cm ground plane)

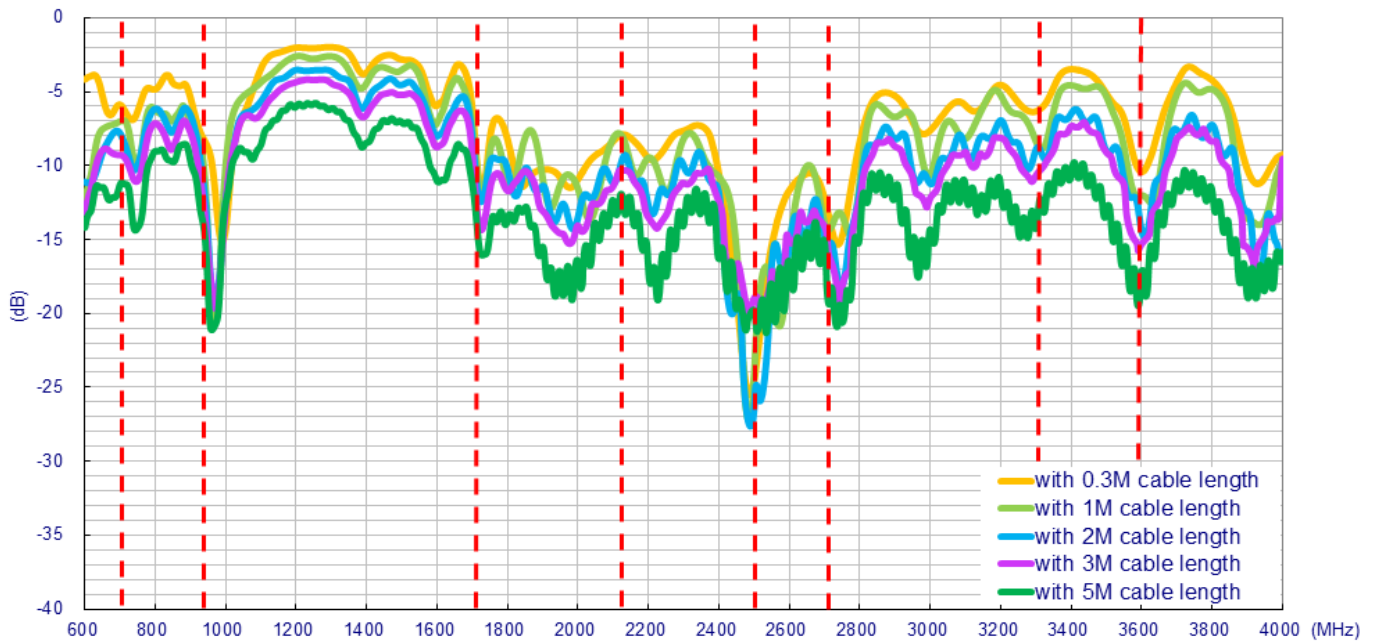

#### 7.1.2 Return Loss (MIMO\_2 on the 50\*50cm ground plane)

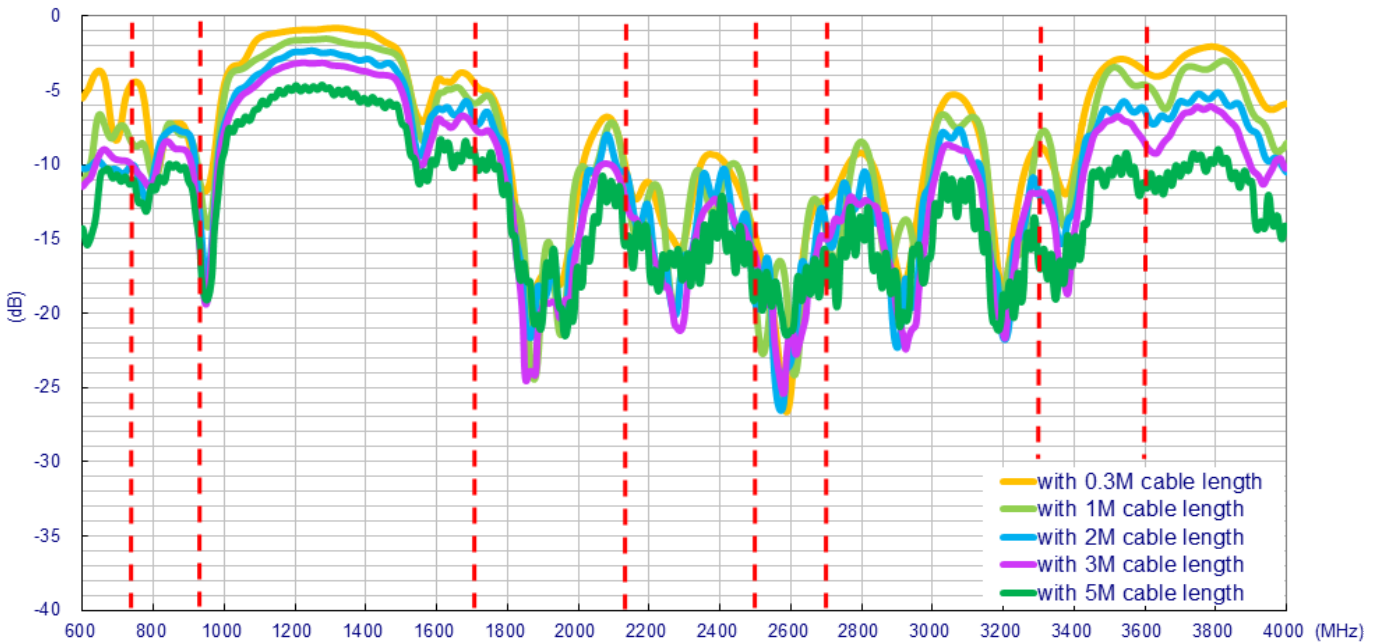

### 7.1.2. Insertion Loss (on the 50\*50cm ground plane)

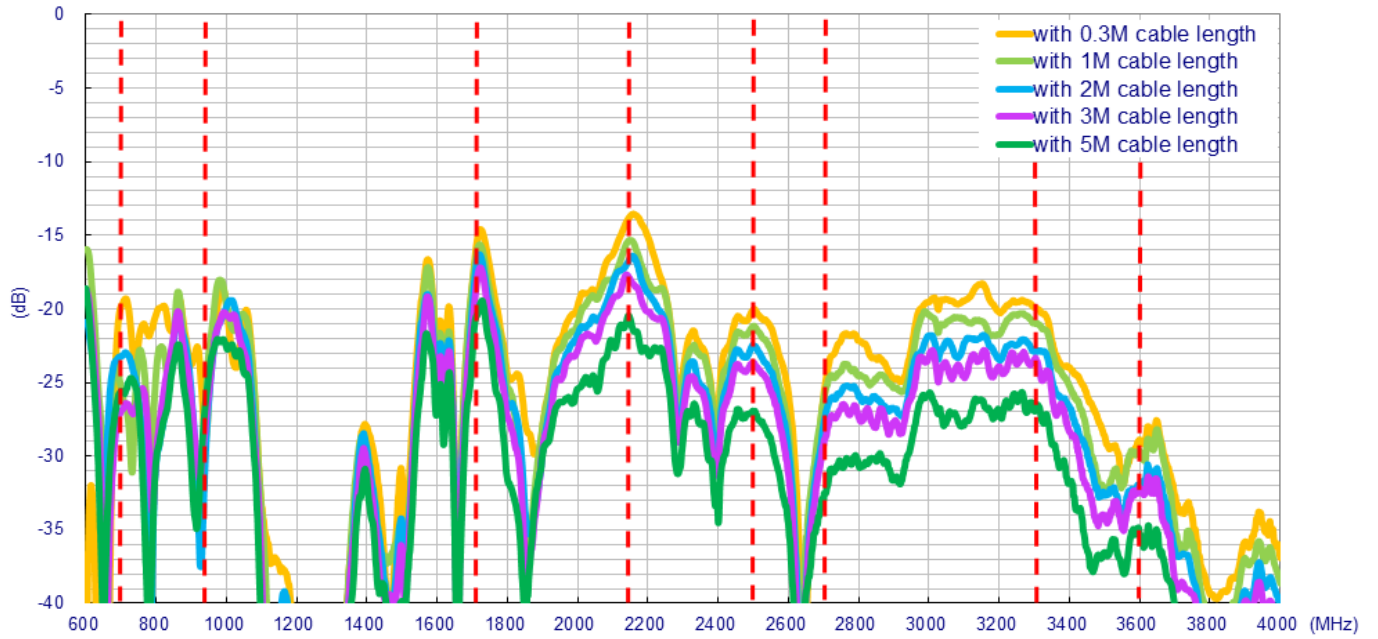

### 7.1.3. Efficiency (MIMO\_1 on the 50\*50cm ground plane)

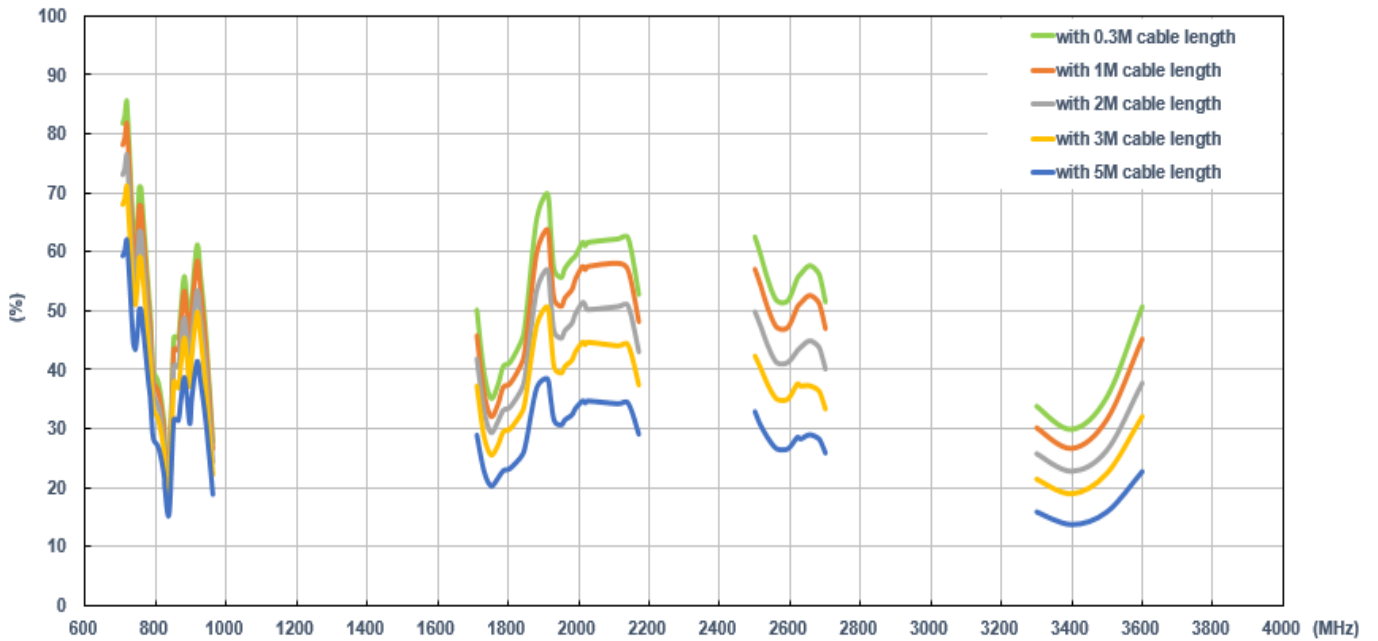

### 7.1.4. Efficiency (MIMO\_2 on the 50\*50cm ground plane)

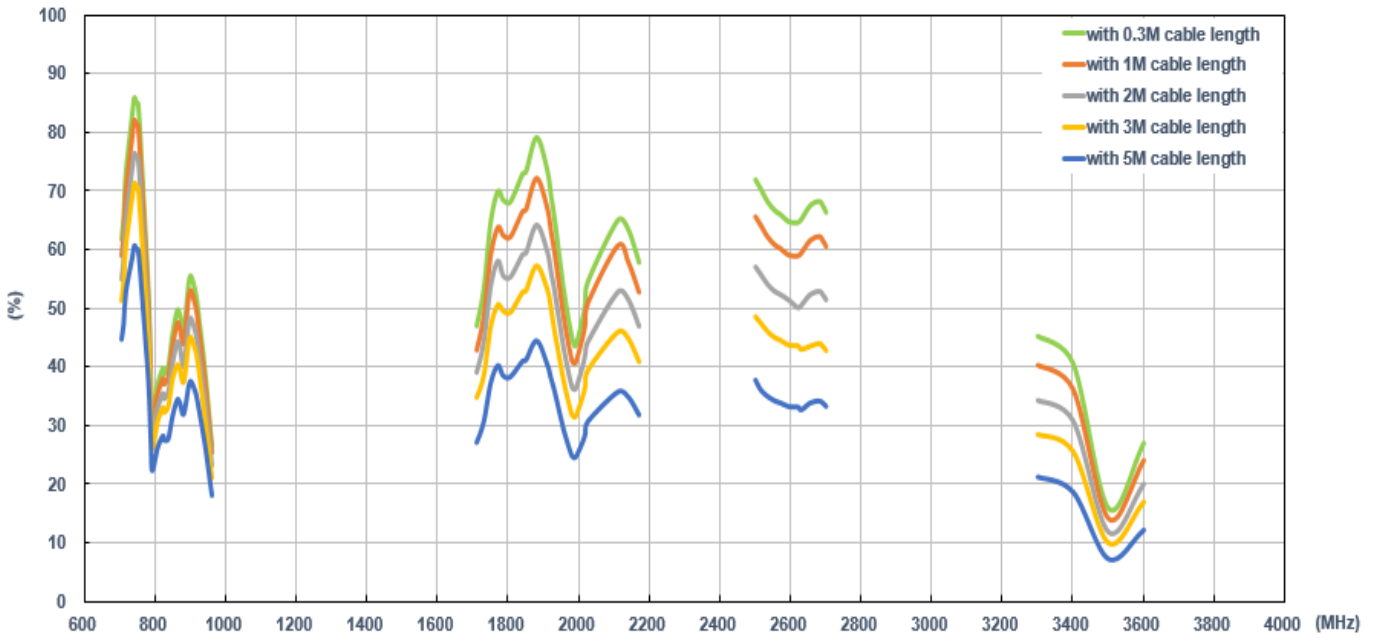

### 7.1.5. Average Gain (MIMO\_1 on the 50\*50cm ground plane)

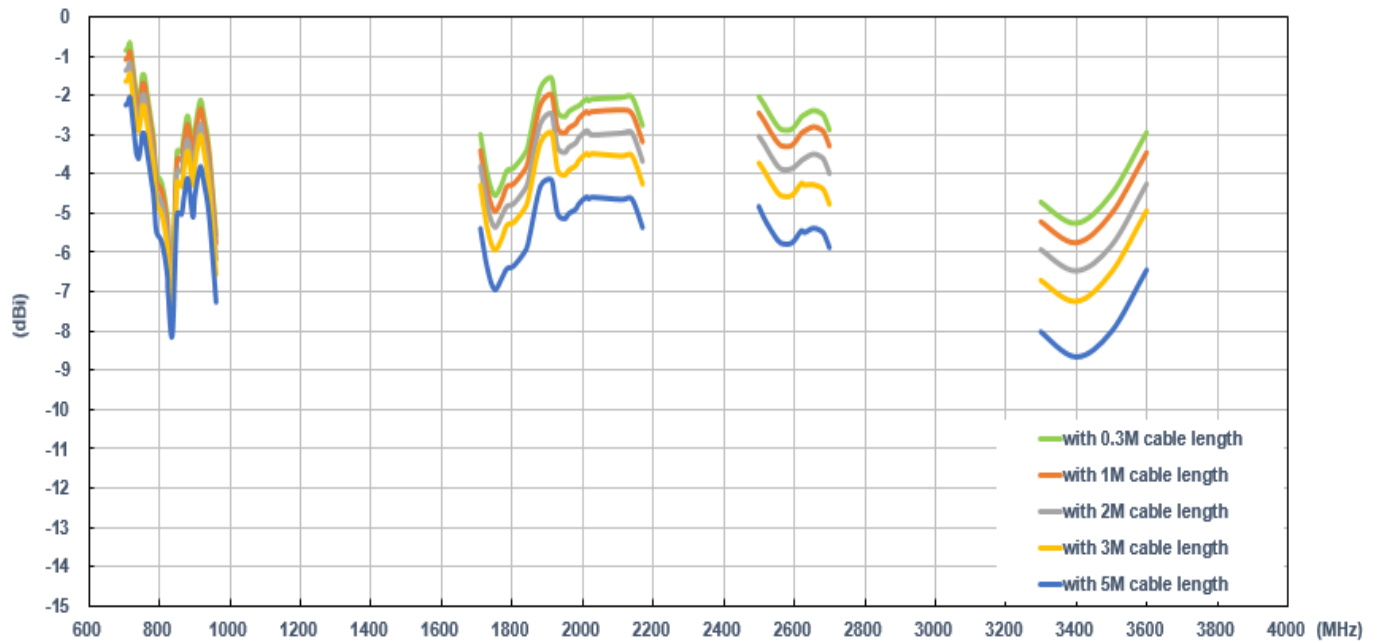

7.1.6. Average Gain (MIMO\_2 on the 50\*50cm ground plane)

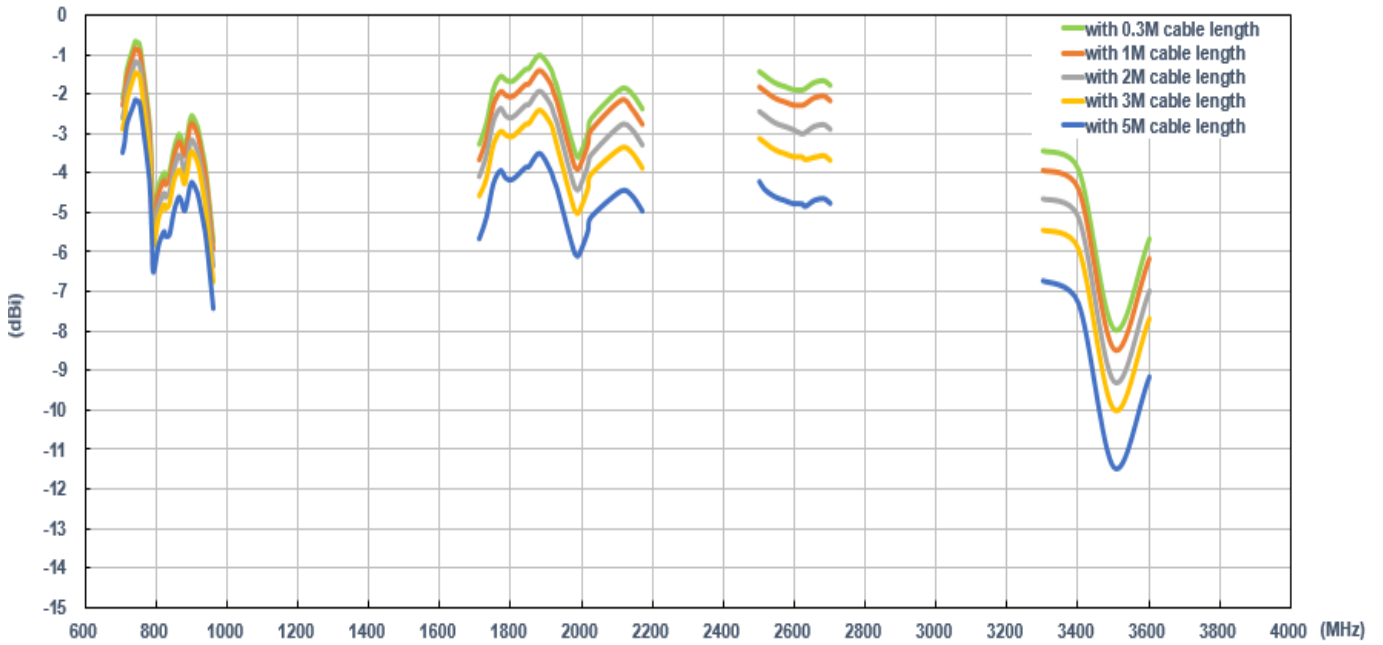

7.1.7. Peak Gain (MIMO\_1 on the 50\*50cm ground plane)

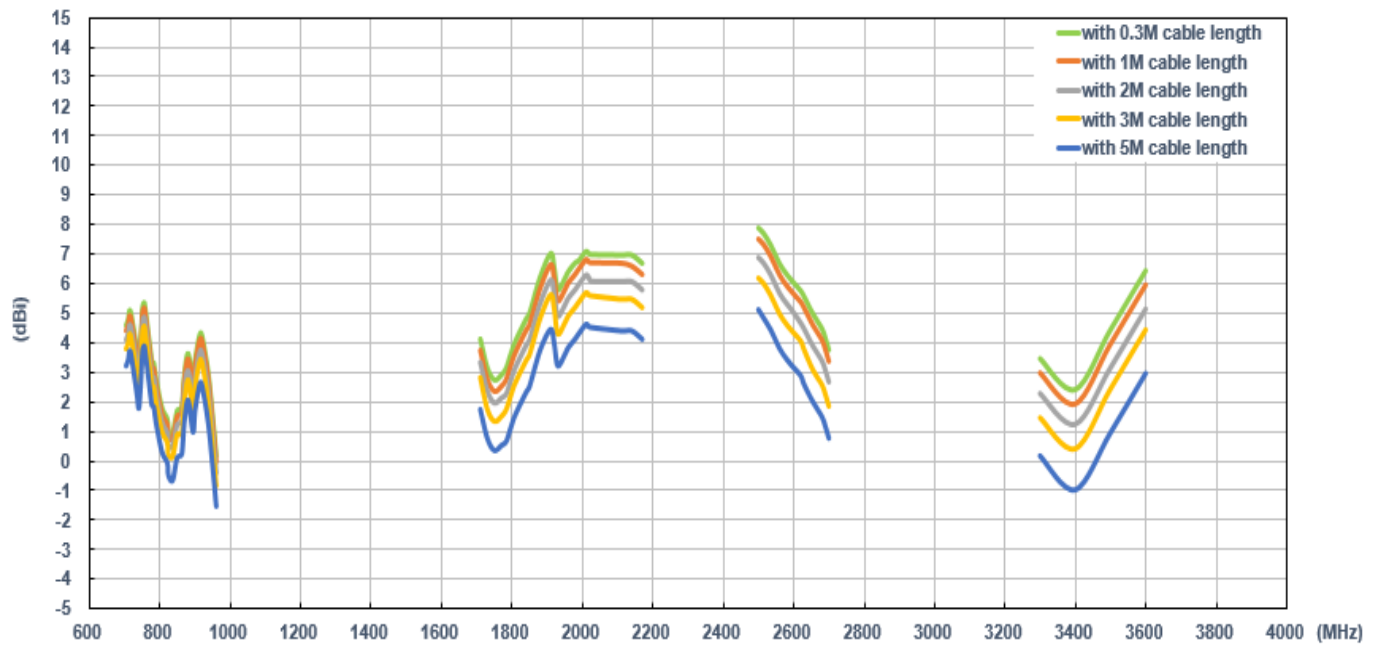



### 7.1.8. Peak Gain (MIMO\_2 on the 50\*50cm ground plane)

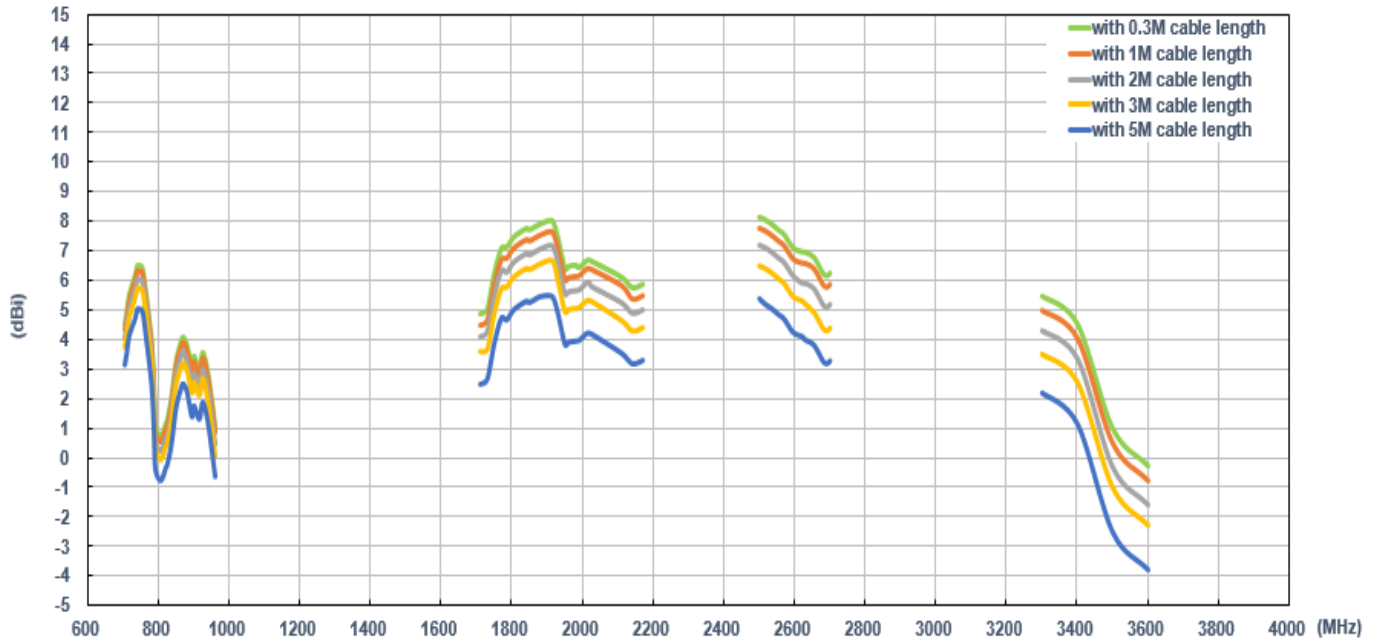

## 7.2. In Free Space

### 7.2.1. Return Loss (MIMO\_1 in free space)

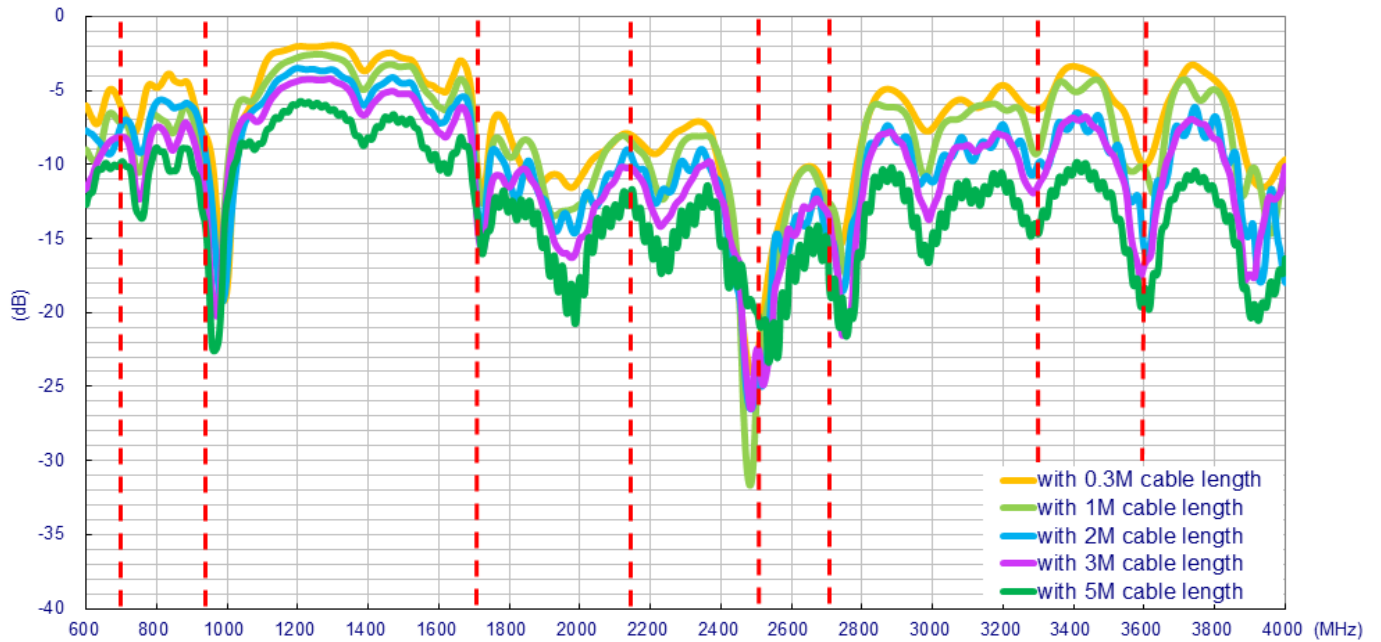

### 7.2.2. Return Loss (MIMO\_2 in free space)

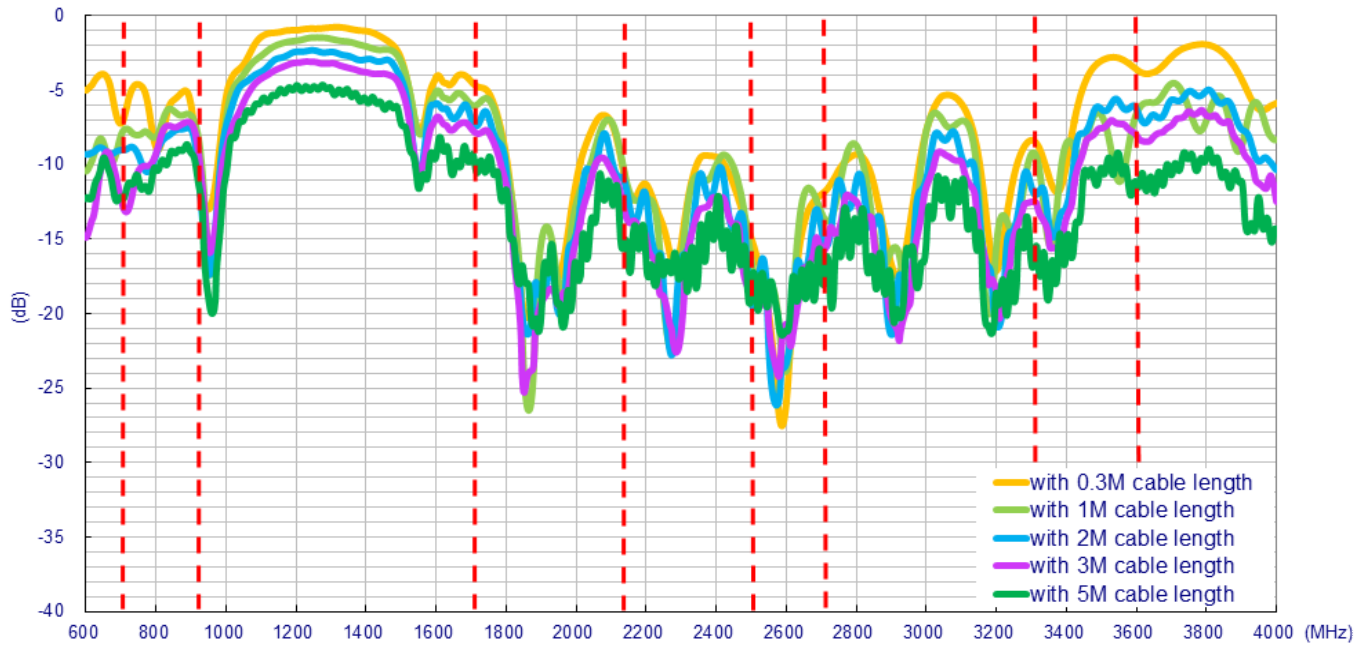

### 7.2.3. Insertion Loss (in free space)

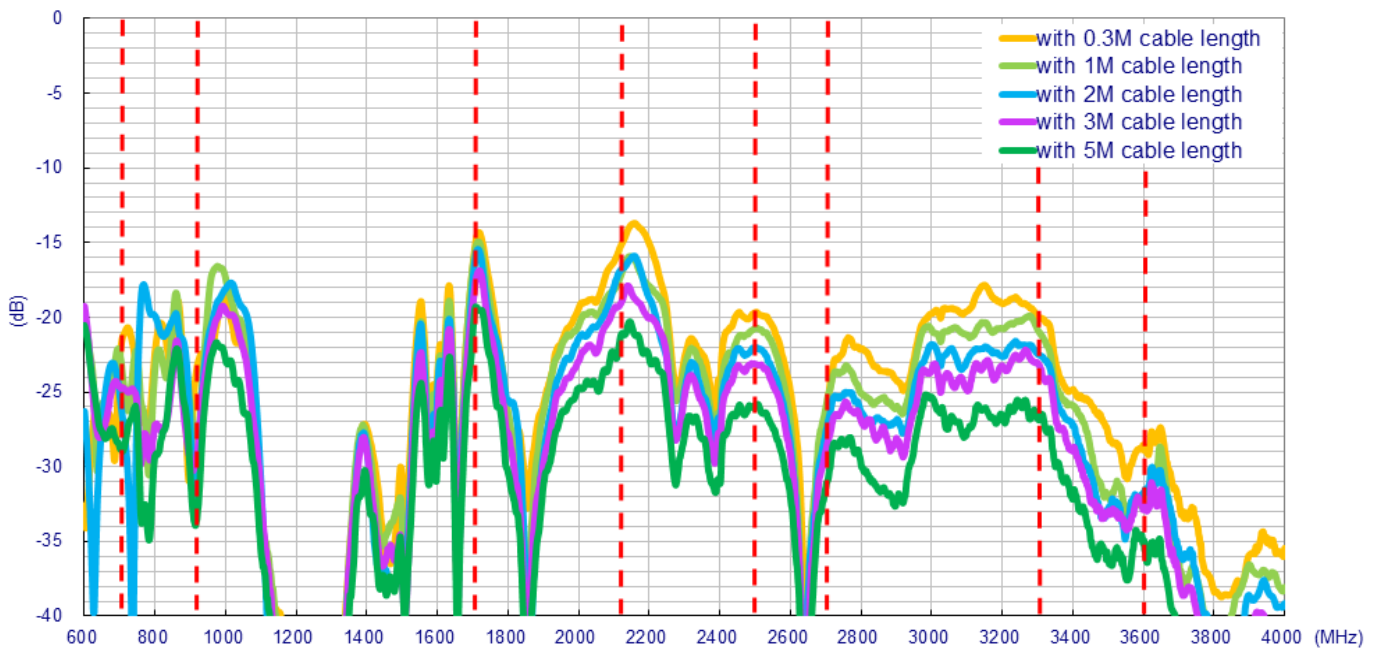

### 7.2.4. Efficiency (MIMO\_1 in free space)

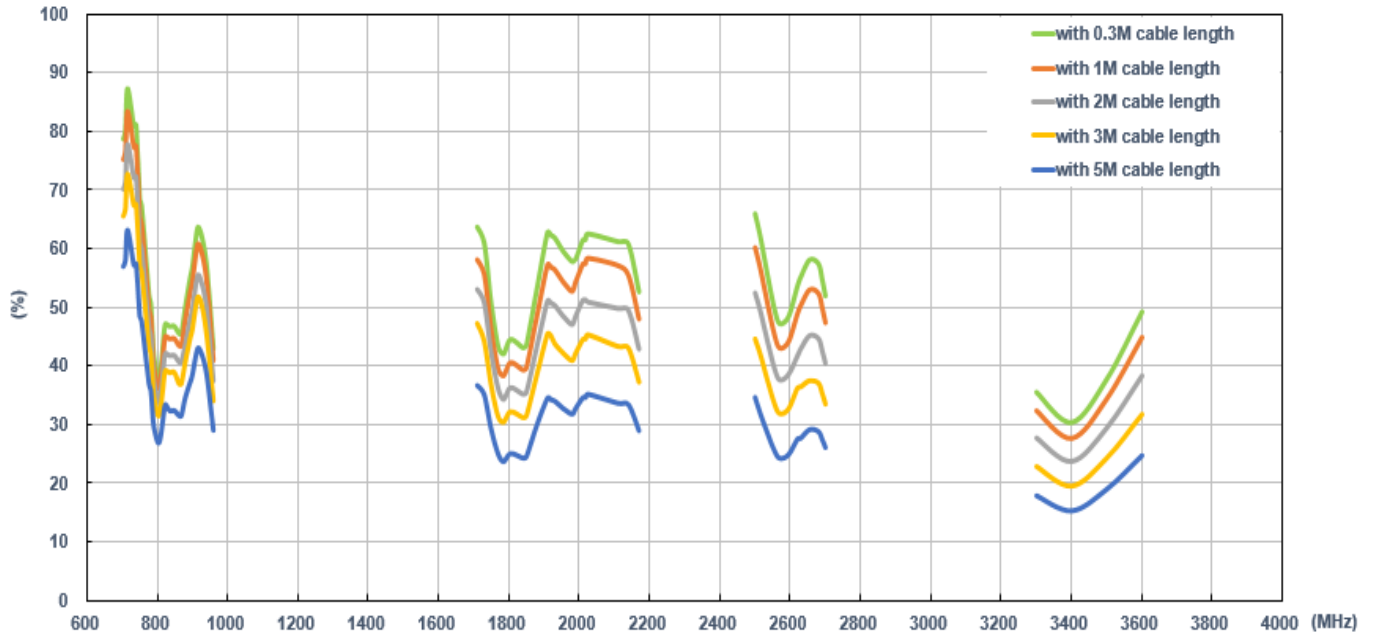

### 7.2.5. Efficiency (MIMO\_2 in free space)

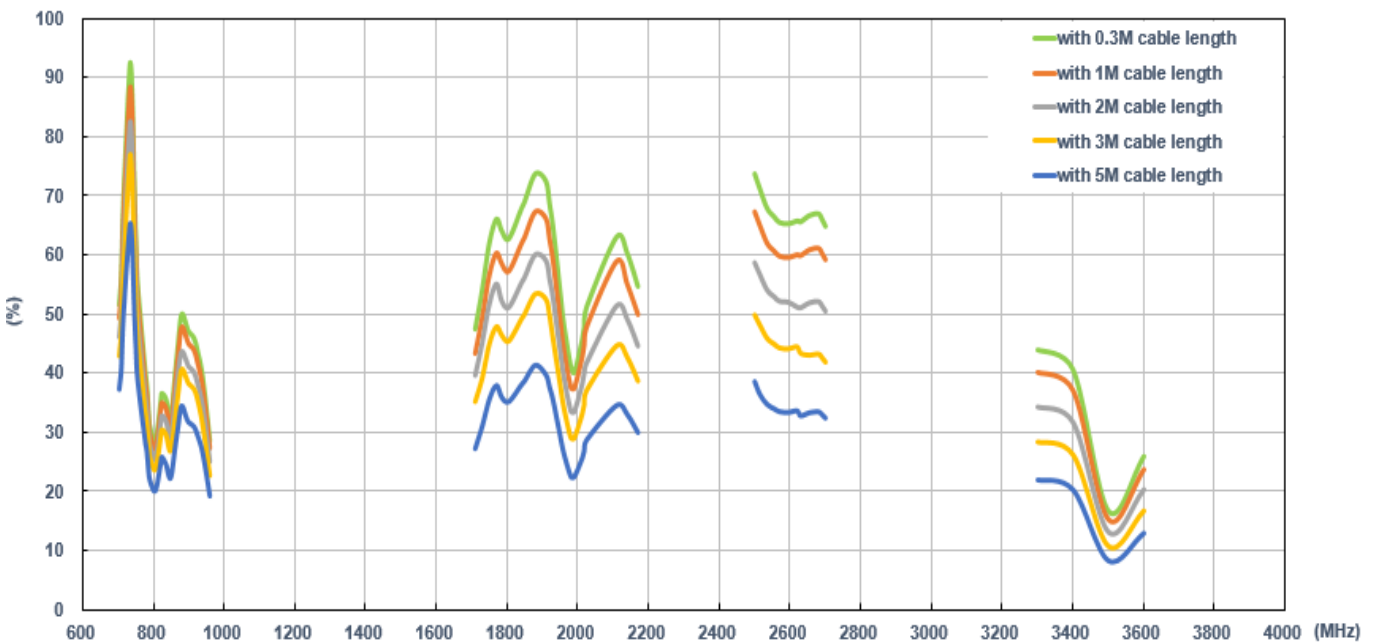

### 7.2.6. Average Gain (MIMO\_1 in free space)

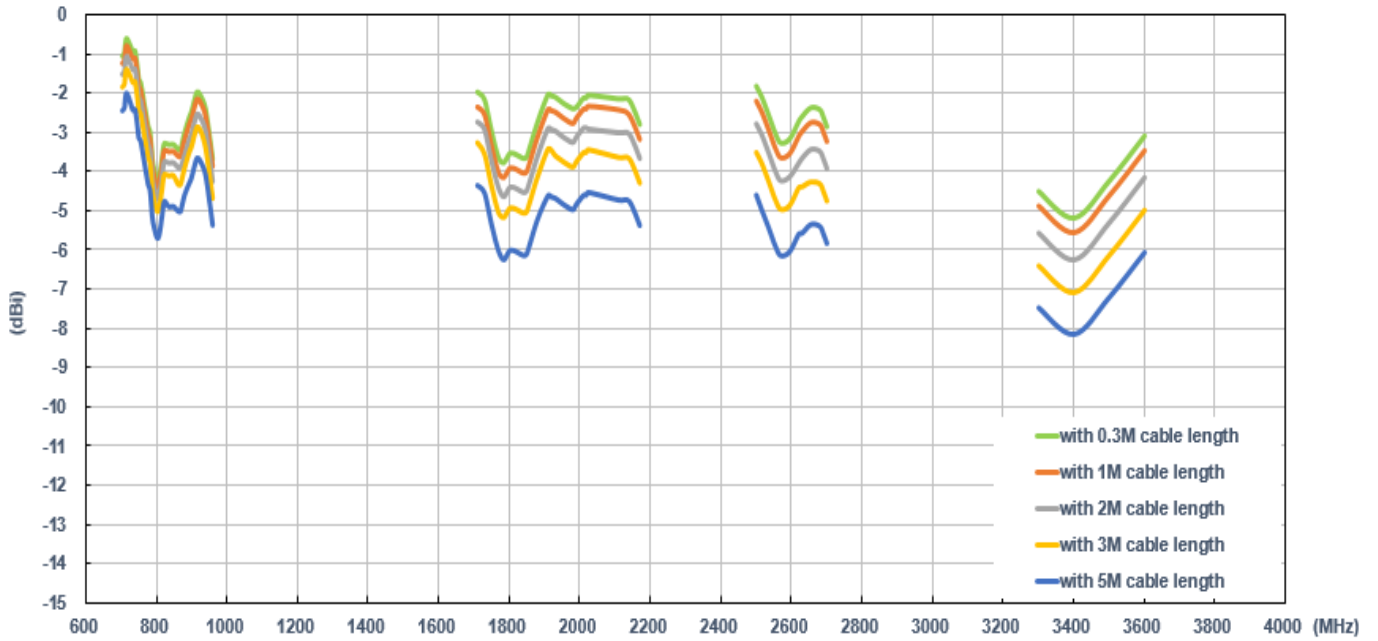

### 7.2.7. Average Gain (MIMO\_2 in free space)

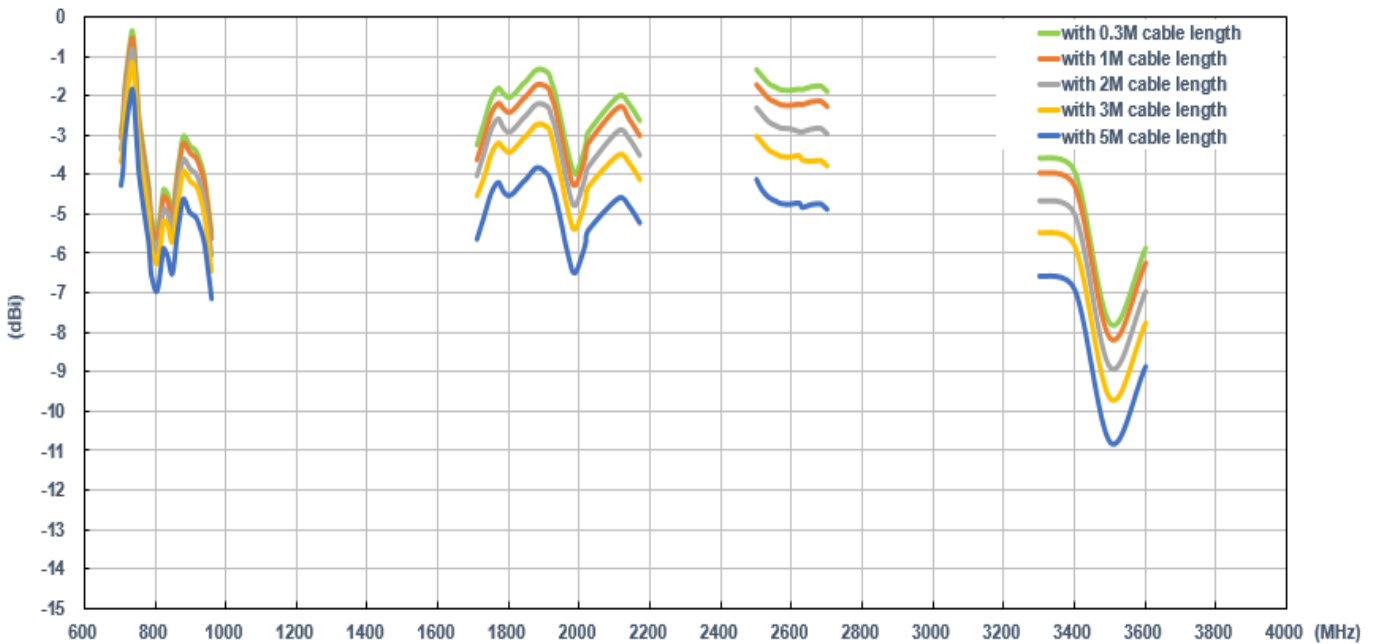

### 7.2.8. Peak Gain (MIMO\_1 in free space)

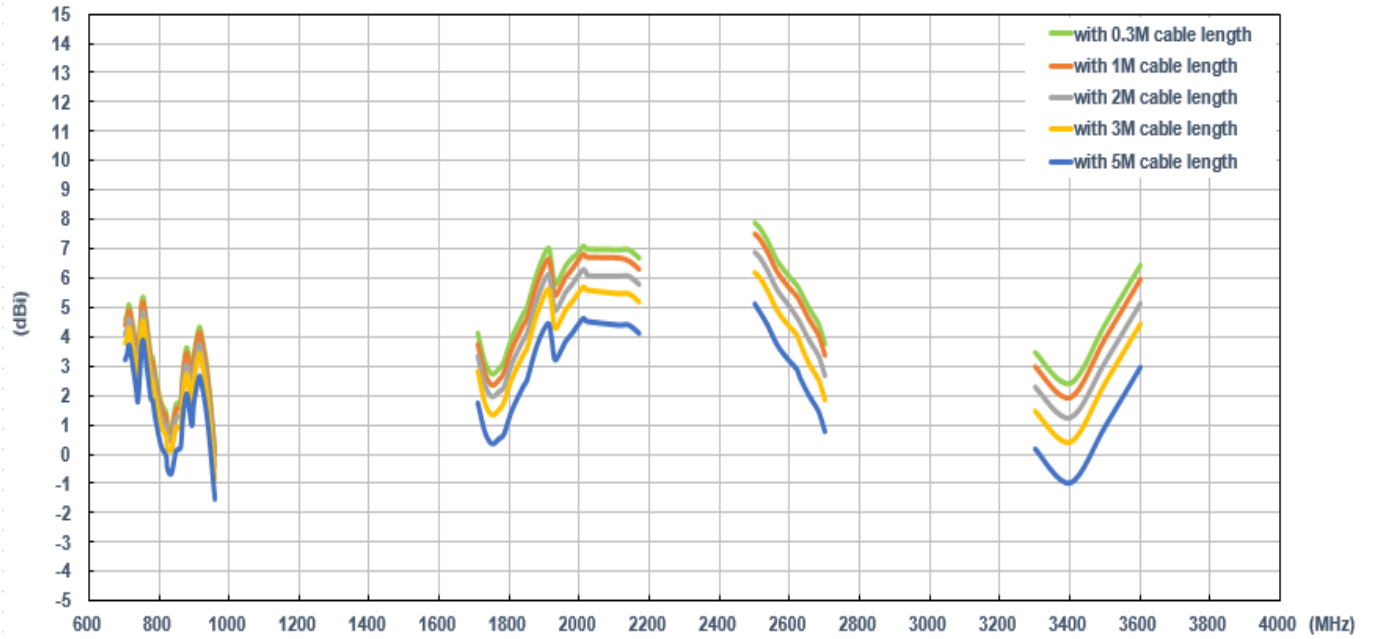

### 7.2.9. Peak Gain (MIMO\_2 in free space)

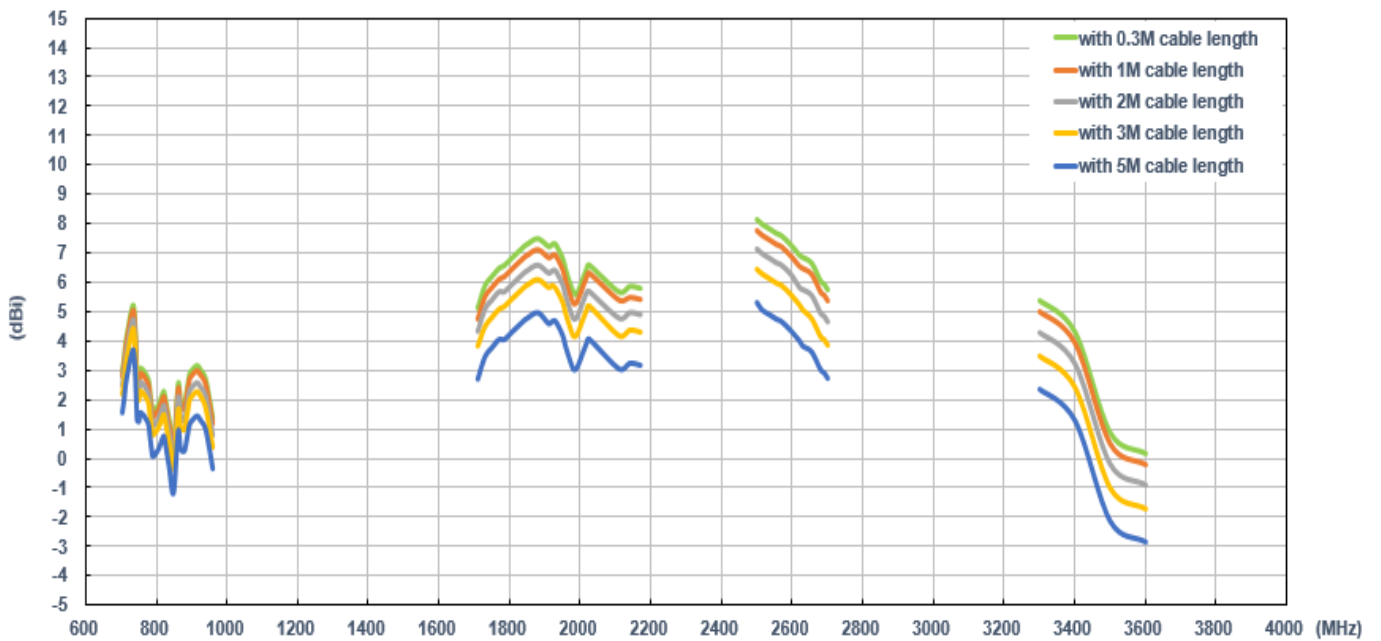



Taoglas makes no warranties based on the accuracy or completeness of the contents of this document and reserves the right to make changes to specifications and product descriptions at any time. Taoglas reserves all rights to this document and the information contained herein.

Reproduction, use or disclosure to third parties without express permission is strictly prohibited.

Copyright © Taoglas