

IEC Appliance Outlet F or H, Screw-on Mounting, Front Side, Solder, PCB or Quick-connect Terminal



Flange with countersunk holes



Flange with through holes special type

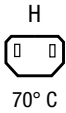
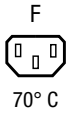

See below:

**Approvals and Compliances**

**Description**

- Panel Mount :  
Screw-on mounting , from front side
- 1 Function :

- Connector , Pin temperature 70 °C , protection class I or II ,
- Solder, Quick Connect or PCB Terminal

**Weblinks**

[pdf datasheet](#), [html-datasheet](#), [General Product Information](#), [Distributor-Stock-Check](#), [Accessories](#), [Detailed request for product](#)

**Technical Data**

Ratings IEC	10A / 250VAC; 50Hz
Ratings UL/CSA	15A / 250VAC; 60Hz
Dielectric Strength	> 4 kVAC between L-N > 2 kVAC between L/N-PE (1 min/50Hz)
Allowable Operation Temperature	-25 °C to 70 °C
IP-Protection	from front side IP 20 acc. to IEC 60529
Insulation cover	Suitable for appliances with protection class I or II acc. to IEC 61140
Terminal	Solder, Quick Connect or PCB Terminal straight
Material: Housing	PA6, black or grey, UL 94V-0

**Approvals and Compliances**

Detailed information on product approvals, code requirements, usage instructions and detailed test conditions can be looked up in [Details about Approvals](#)

**Approvals**





The approval mark is used by the testing authorities to certify compliance with the safety requirements placed on electronic products.

Approval Reference Type: 5091

Approval Logo	Certificates	Certification Body	Description
	<a href="#">VDE Approvals</a>	VDE	VDE Certificate Number: 40010295
	<a href="#">UL Approvals</a>	UL	UL File Number: E57445
	<a href="#">CSA Approvals</a>	CSA	CSA Certification Record: 27324

## Product standards

Product standards that are referenced

Organization	Design	Standard	Description
	Designed according to	IEC 60320-1	Appliance couplers for household and similar general purposes
	Designed according to	IEC 60320-1	Appliance couplers for household and similar general purposes
	Designed according to	UL 498	Standard for Attachment Plugs and Receptacles
	Designed according to	CSA C22.2 no. 42	General Use Receptacles, Attachment Plugs, and Similar Wiring Devices





## Application standards

Application standards where the product can be used

Organization	Design	Standard	Description
	Designed for applications acc.	IEC/UL 60950	IEC 60950-1 includes the basic requirements for the safety of information technology equipment.

## Compliances

The product complies with following Guide Lines

Identification	Details	Initiator	Description
	<a href="#">CE declaration of conformity</a>	SCHURTER AG	The CE marking declares that the product complies with the applicable requirements laid down in the harmonisation of Community legislation on its affixing in accordance with EU Regulation 765/2008.
	RoHS	SCHURTER AG	EU Directive RoHS 2011/65/EU
	China RoHS	SCHURTER AG	The law SJ / T 11363-2006 (China RoHS) has been in force since 1 March 2007. It is similar to the EU directive RoHS.
	REACH	SCHURTER AG	On 1 June 2007, Regulation (EC) No 1907/2006 on the Registration, Evaluation, Authorization and Restriction of Chemicals 1 (abbreviated as "REACH") entered into force.

## Dimensions [mm]

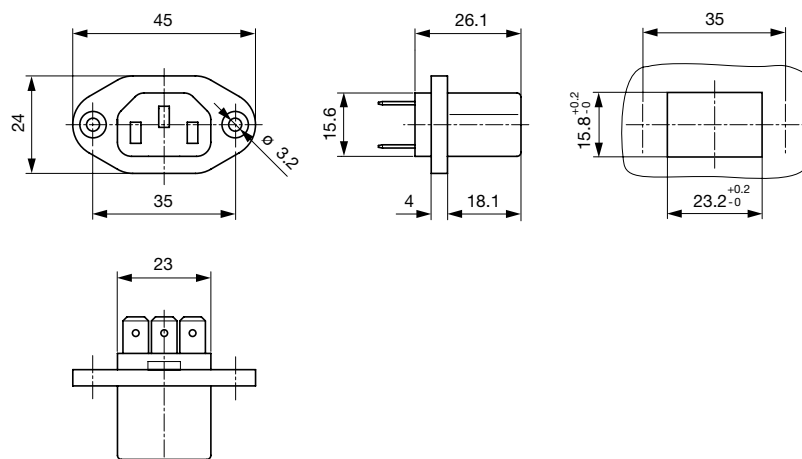

Flange with countersunk holes

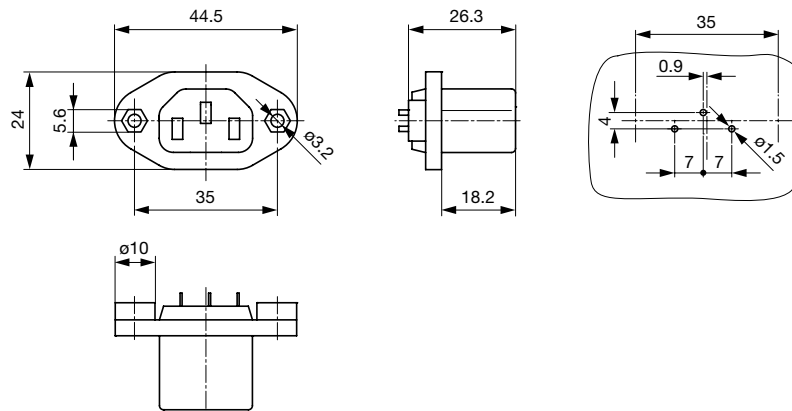

Flange with through holes special type

### Config. Code

5091 - H - A B C 0 - D - E O

The characters are placeholders for the correspondingly keys of selections from the key tables.



5091 - H - A B C 0 - D - E O = Type

Type	Configuration key
protection class II	B
protection class I	X

Terminal Ground	Configuration key
without terminal	0
solder terminal	1
PCB-terminal standard (additional solder terminal)	4
Blade terminal (6.3 x 0.8 mm)	9

Symbols similar as in table A

5091 - H - A B C 0 - D - E O = Terminals

Terminal L	Configuration key
solder terminal 	1
PCB-terminal standard (additional solder terminal) 	4
Blade terminal (6.3 x 0.8 mm) 	9

5091 - H - A B C 0 - D - E O = Color

Color	Configuration key
Black	A
Grey	B

5091 - H - A B C 0 - D - E O = Style

Style	Configuration key
flange with countersunk holes	1
flange with through holes	2
flange with through holes (special type)	7

5091 - H - A B C 0 - D - E O = Terminals

Terminal N	Configuration key
solder terminal	1
PCB-terminal standard (additional solder terminal)	4
Blade terminal (6.3 x 0.8 mm)	9

Symbols similar as in table A

5091 - H - A B C 0 - D - E O = Features

Features	Configuration key
not used	0
dead cover	1
holder for 1 fuse (text legible, when inlet on top)	2
holder for 1 fuse (text legible, when inlet on bottom)	3
holder for 1 or 2 fuses (text legible, when inlet on top)	4

5091 - H - A B C 0 - D - E O = Terminals

Features	Configuration key	Features	Configuration key
holder for 1 or 2 fuses (text legible, when inlet on bottom)	5	thermal circuit breaker for rated current 8A	C
voltage selector with 1 fuse	6	thermal circuit breaker for rated current 10A	D
voltage selector with 2 fuses	7	thermal circuit breaker for rated current 15A	E
thermal circuit breaker for rated current 4A	A	thermal circuit breaker for rated current 20A	F
thermal circuit breaker for rated current 6A	B		

## All Variants

Type	Terminals L / N	Terminal Ground	Color	Style	Features	Config. Code	Order Number
protection class I	solder terminal	solder terminal	Grey	flange with countersunk holes	-	5091-X-1110-B-1	6182.0002
protection class I	PCB-terminal standard (additional solder terminal)	PCB-terminal standard (additional solder terminal)	Black	flange with through holes (special type)	-	5091-X-4440-A-7	6182.0004
protection class I	PCB-terminal standard (additional solder terminal)	PCB-terminal standard (additional solder terminal)	Grey	flange with through holes (special type)	-	5091-X-4440-B-7	6182.0005
protection class I	Blade terminal (6.3 x 0.8 mm)	Blade terminal (6.3 x 0.8 mm)	Black	flange with countersunk holes	-	5091-X-9990-A-1	6182.0006
protection class I	Blade terminal (6.3 x 0.8 mm)	Blade terminal (6.3 x 0.8 mm)	Grey	flange with countersunk holes	-	5091-X-9990-B-1	6182.0008

The listed variants should be available from stock. Other versions on request [www.schurter.com/contact](http://www.schurter.com/contact)

Most Popular.

Availability for all products can be searched real-time: <https://www.schurter.com/en/Stock-Check/Stock-Check-SCHURTER>

**Packaging unit** 100 Pcs

## Mating Inlets/Plugs

### Category / Description

#### Appliance Inlet Overview complete



6100-3, Mounting: Screw, Solder terminals or quick connect terminals, Appliance Inlet: IEC C14	6100-3
6100-4, Mounting: Snap-in, Solder terminals or quick connect terminals, Appliance Inlet: IEC C14	6100-4
G-Stecker, Mounting: Appliance Inlet : IEC C14 Without fuse holder	6150
6010, Mounting: Snap-in, Solder, quick-connect, screw, PCB, Appliance Inlet: IEC C14	6010
0711, Mounting: Snap-in, 0.8 mm, Solder, Appliance Inlet: IEC C14	0711

[Appliance Inlet further types to 5091](#)

...

#### Distribution Unit Overview complete



Distribution Unit for Snap-in Mounting with 1 IEC Appliance Inlet C14 and 1 Appliance Outlet F	0712
Distribution Unit with 1 IEC Appliance Inlet C14 and 2 Appliance Outlets F, Shuttered	4741
Distribution Unit with 1 IEC Appliance Inlet C14 and 4 Appliance Outlets F	4747
Distribution Unit with 1 IEC Appliance Inlet C14 or Power Cord, 4, 5 or 6 IEC Appliance Outlets F and Extra Components	4740
EMC Power Strip with Line Filter	FLBB

[Distribution Unit further types to 5091](#)

#### IEC Inlet Filter Overview complete



GRF2, Mounting: Rear Side, With EMC-shield and without line filter, 10 A, Plug Connector, Appliance Inlet: IEC C14, Suitable for appliances with protection class I	GRF2
5110, Mounting: Screw, Front Side, Filter: Standard and Medical Version, Without fuse holder: 10 A, Thermoplastic Appliance Inlet: IEC C14, prewired, Suitable for appliances with protection class I	5110
KFS, Mounting: Screw, Front Side, Filter: Standard Version, Without fuse holder: 10 A, Appliance Inlet: IEC C14, pre-wired	KFS

[IEC Inlet Filter further types to 5091](#)

Category / Description

[Power Entry Module Overview complete](#)



DD11, Mounting: Screw-on mounting, Rocker switch: non-illuminated or illuminated 2-pole, Quick connect terminals 4.8 x 0.8 mm, Appliance Inlet: IEC C14, With or without protection cover, Fuse holder: 1 or 2 pole, Suitable for appliances with protection class I	DD11
DD21, Mounting: Screw-on mounting Rear Side, Rocker switch: non-illuminated or illuminated 2-pole, additional quick connect 4.8 x 0.8 mm Appliance Inlet: IEC C14, Fuse holder: 1 or 2 pole	DD21
DC11, Mounting: Screw, Rocker switch: non-illuminated or illuminated 1 or 2 pole, Quick connect terminals 4.8 x 0.8 mm, Appliance Inlet: IEC C14, Without fuse holder: Suitable for appliances with protection class I or II	DC11
KEB1, Mounting: Screw, Quick connect terminals 4.8 x 0.8 mm, Without fuse holder: Rocker switch, non-illuminated or illuminated, red, 1-pole, Appliance Inlet: IEC C14, 250 VAC, prewired, Suitable for appliances with protection class I	KEB1
KEB2, Mounting: Screw, Quick connect terminals 4.8 x 0.8 mm, Without fuse holder: Rocker switch, non-illuminated or illuminated, 2-pole, Appliance Inlet: IEC C14, 250 VAC, prewired, Suitable for appliances with protection class I	KEB2

[Power Entry Module further types to 5091](#)

...

[Power Entry Module with line filter Overview complete](#)



DD14, Mounting: Screw-on mounting, Front Side, Filter, Standard and Medical Version, Fuse holder: 1 or 2 pole, 10 A, Rocker switch: 2-pole, non-illuminated Appliance Inlet: IEC C14, prewired	DD14
KFB1, Mounting: Screw, Front Side, Filter: Standard Version, Without fuse holder: 10 A, Rocker switch: 1-pole, Appliance Inlet: IEC C14, prewired	KFB1
KFB2, Mounting: Screw, Front Side, Filter: Standard and Medical Version, Without fuse holder: 10 A, Rocker switch: 2-pole, Appliance Inlet: IEC C14, prewired	KFB2
DC12, Mounting: Screw, Front-/Rear-Side, Filter, Standard and Medical Version, Without fuse holder: 10 A, Rocker switch: 1 or 2 pole, non-illuminated or illuminated Appliance Inlet: IEC C14, prewired	DC12
DC22 Mounting: Screw, Rear Side, PCB, 10 A, Filter: Standard and Medical Version, Without fuse holder: Rocker switch: 1 or 2 pole, non-illuminated or illuminated, Appliance Inlet: IEC C14, Suitable for appliances with protection class I	DC22

[Power Entry Module with line filter further types to 5091](#)

...