

01

0105

DIN circular connectors

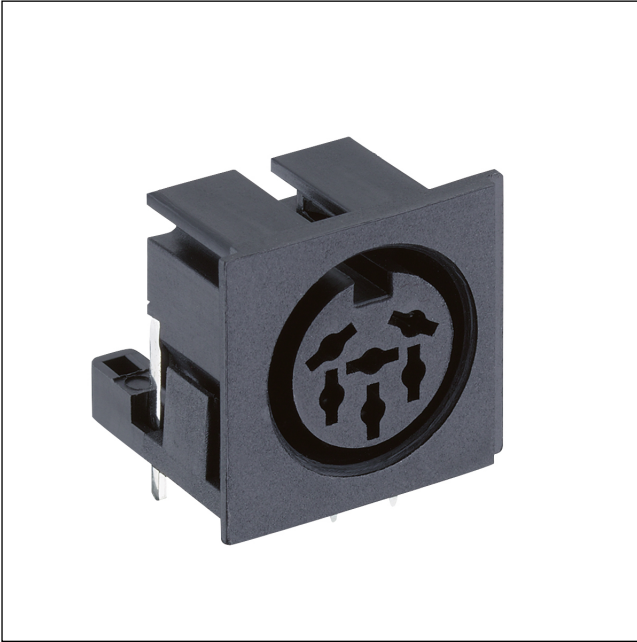

DIN chassis socket, right angle version, with ground contact, suitable for locking, for printed circuit boards

01

0105

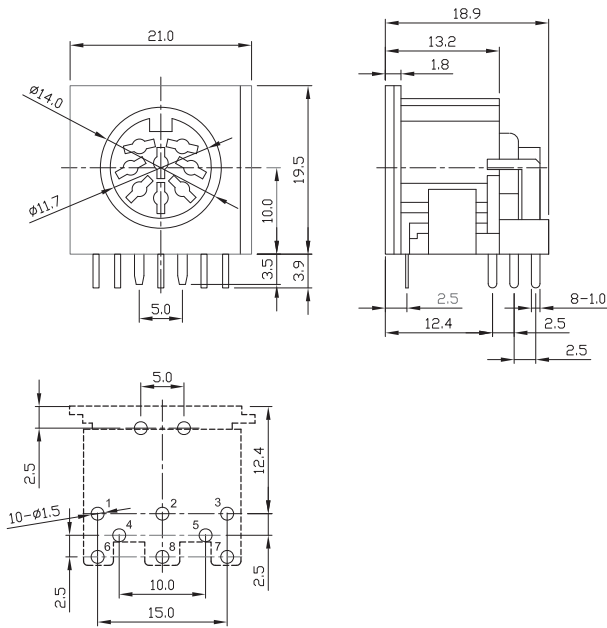

DIN 41524

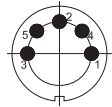

0105 05

DIN 45322

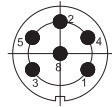

0105 06

DIN 45326

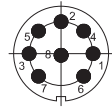

0105 08-1

- \*a distance of ground contact pins 5 mm
- \*b Printed circuit board layout, solder side view

### Environmental conditions

Temperature range -20 °C/+70 °C

### Materials

Insulating body	PBT, V-0 according to UL94
Contact spring	CuZn, tin-plated
Ground contact spring	CuZn, tin-plated
Cover	PBT, V-0 according to UL94



### Mechanical data

Mating cycles	5000
Insertion force	4,9–49 N
Withdrawal force	4,9–49 N

### Electrical data (at T<sub>amb</sub> 20 °C)

Contact resistance	≤ 20 mΩ
Rated current	4 A
Rated voltage	24 V AC
Rated impulse voltage	1000 V AC/60 s
Insulation resistance	≥ 100 MΩ

### Associated products

Counterparts  
 0131       0137

01

0105

Designation	Pole Number	PU (Pieces)	MDQ (Pieces)
0105 05	5	100	300
0105 06	6	100	300
0105 08-1	8	100	300

**Packaging:**  
in a tray