

DC/DC Converter for IGBT driver



Patent Protection **RoHS**

FEATURES

- High efficiency up to 81%
- Ultra Compact SIP package
- Isolation voltage: 3K VAC
- Max. Capacitive Load: 1000uF
- Ultra low isolation capacitance
- Operating temperature range: -40°C to +105°C
- No-load operation allowed

QAxx1 series are DC-DC converters for IGBT drivers. Their ultra low isolation capacitance can improve the capability of anti-interference. The built-in common-ground mode of the unique asymmetric voltage output mode reduces the driver loss of IGBT driver. They feature short-circuit protection and auto-recovery, and can be widely used in:

1. General inverter
2. AC servo drive system
3. Electric welding machine
4. Uninterruptible power supply (UPS)

Selection Guide

Part No.	Input		Output		Efficiency (%Min./Typ) @ Full Load	Max. Capacitive Load (μF)
	Input Voltage(VDC)	Input Current(mA, Typ.)	Output Voltage (VDC)+Vo/-Vo	Output Current (mA)+Io/-Io		
	Nominal(Range)	full load/no-load				
QA121	12 (11.4-12.6)	280/40	+15/-8.0	+120/-120	78/81	1000
QA151	15 (14.25-15.75)	230/35				
QA241	24 (22.8-25.2)	144/30				

Input Specifications

Item	Operating Conditions		Min.	Typ.	Max.	Unit
Input Surge Voltage	QA121	DC	-0.7	--	14	VDC
	QA151	DC	-0.7	--	16	
	QA241	DC	-0.7	--	26	
Input Filter			Filter capacitor			
Hot Plug			Unavailable			

Output Specifications

Item	Operating Conditions		Min.	Typ.	Max.	Unit	
Output Voltage	QA121	+Vo	Vin=12VDC, Pin6 & Pin7 +Io= +120mA	14.25	15	15.75	VDC
		-Vo	Vin=12VDC, Pin5 & Pin6 -Io= -120mA	-6.4	-8	-9.6	
	QA151	+Vo	Vin=15VDC, Pin6 & Pin7 +Io= +120mA	14.25	15	15.75	
		-Vo	Vin=15VDC, Pin5 & Pin6 -Io= -120mA	-6.4	-8	-9.6	
	QA241	+Vo	Vin=24VDC, Pin6 & Pin7 +Io= +120mA	14.25	15	15.75	
		-Vo	Vin=24VDC, Pin5 & Pin6 -Io= -120mA	-6.4	-8	-9.6	
Output Voltage Accuracy	100mA load		Positive output	-5	--	+5	%
			Negative output	-20	--	+20	
		10% -100% load	See tolerance envelope Curve(Fig. 2, Fig. 3)				
Line Regulation	Input voltage range		Positive output	-5	--	+5	%
			Negative output	-20	--	+20	
Load Regulation	10%-100% load		Positive output	--	8	15	%
			Negative output	--	10	15	

Temperature Coefficient	Full load	--	--	±0.03	%/°C
Ripple & Noise*	20MHz bandwidth	--	100	200	mVp-p
Output Short Circuit Protection		--	--	1	s

Note: * Ripple and noise are measured by "parallel cable" method, please see DC-DC Converter Application Notes for specific operation.

General Specifications

Item	Operating Conditions	Min.	Typ.	Max.	Unit
Isolation Voltage	Input-output, with the test time of 1 minute and the leak current lower than 1mA	3000	--	--	VAC
Insulation Resistance	Input-output, isolation voltage 500VDC	1000	--	--	MΩ
Isolation Capacitance	Input-output, 100KHz/0.1V	--	6	10	pF
Operating Temperature	Derating when operating temperature up to 85°C, (see Fig. 2)	-40	--	105	°C
Storage Temperature		-55	--	125	
Pin Welding Resistance Temperature	Welding spot is 1.5mm away from the casing, 10 seconds	--	--	300	
Casing Temperature Rise	Ta=25°C, nominal input, full load output	--	--	40	
Storage Humidity	Non-condensing	5	--	95	%RH
MTBF	MIL-HDFK-217F@25°C	3500	--	--	K hours

Physical Specifications

Casing Material	Black flame-retardant and heat-resistant plastic
Dimensions	19.50*9.80*12.50mm
Weight	4.3g (Typ.)
Cooling Method	Free air convection

EMC Specifications

EMS	ESD	IEC/EN61000-4-2	Contact ±8KV	perf. Criteria B
	EFT	IEC/EN61000-4-4	±2KV	perf. Criteria B
	Surge	IEC/EN61000-4-5	±2KV (Input to Output)	perf. Criteria B

Product Characteristic Curve

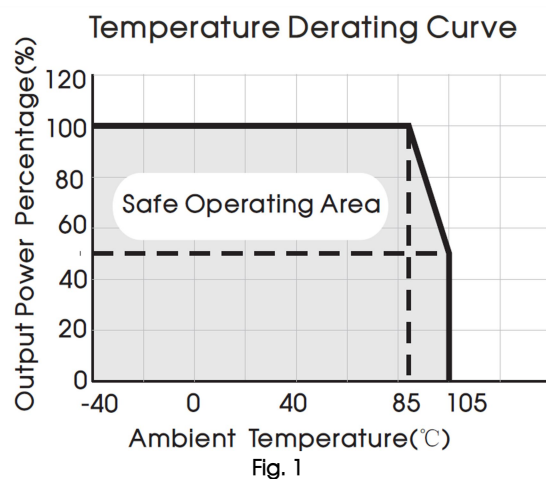

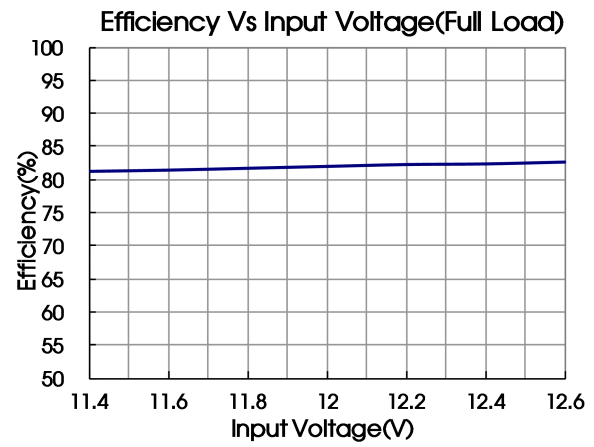
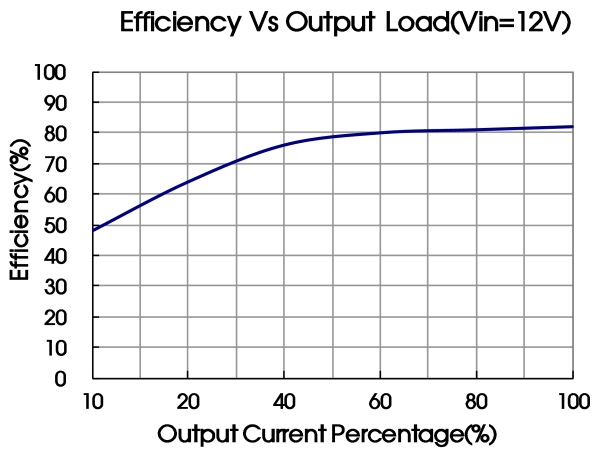
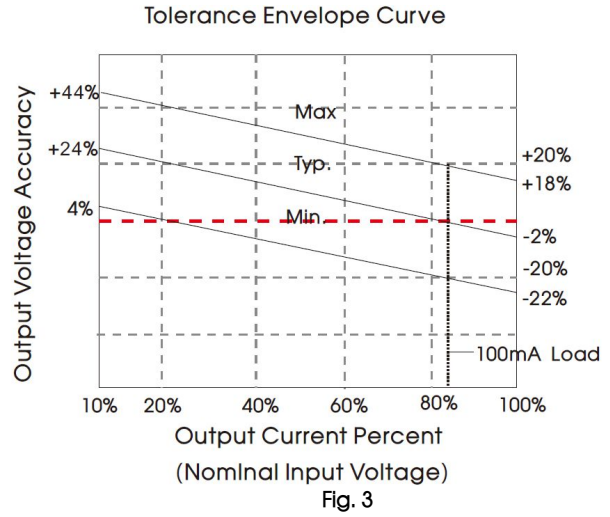
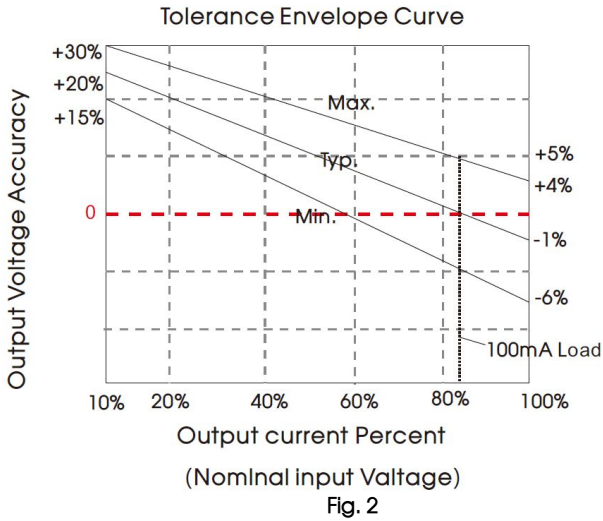

Note: Take QA121 as an example, other models can be corresponding reference

Design Reference

1. Typical application

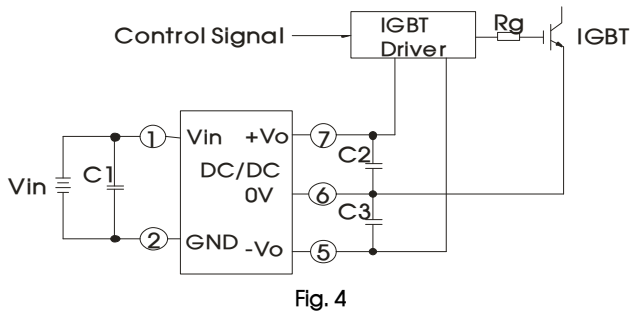

C1/ C2 /C3
100uF/35V (Low internal resistance capacitance)

Note: On both ends of capacitance C2 and C3 shunt respectively a capacitance value in 1uF -10uF ceramic capacitors.

2. It is not allowed to connect modules output in parallel to enlarge the power

3. For more information please find DC-DC converter application notes on www.mornsun-power.com

Dimensions and Recommended Layout

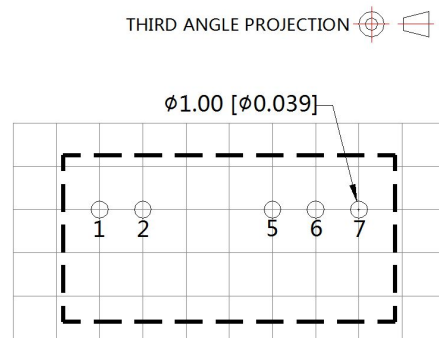
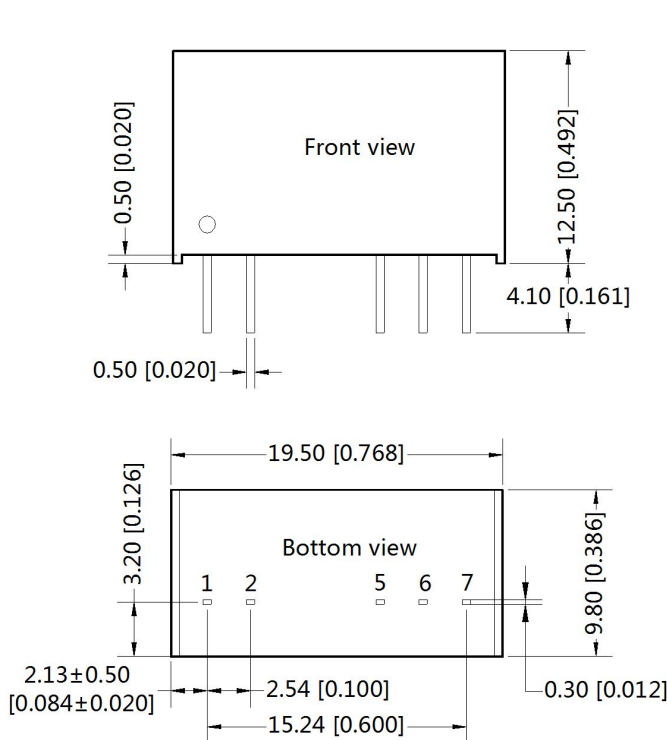

Note: Grid 2.54*2.54mm

Pin-Out	
Pin	Function
1	Vin
2	GND
5	-Vo
6	0V
7	+Vo

Note:
Unit :mm[inch]
Pin section tolerances:±0.10[±0.004]
General tolerances:±0.50[±0.020]

Notes:

1. Packing information please refer to Product Packing Information ,Packing bag number: 58200013;
2. The lead wire connecting the power supply module and IGBT driver should be as short as possible during use;
3. The output filtering capacitor should be as close as possible to the power supply module and IGBT driver;
4. The peak of the IGBT driver gate drive current is high, so low internal resistance electrolytic capacitor is recommended to be used for the power supply module output filter capacitor;
5. The average output power of the driver must be lower than that of the power supply module;
6. Consider fixing in place with glue near the module if being used in vibration occasions;
7. The maximum capacitive load is measured under the full input voltage range and full load condition;
8. Unless otherwise specified, parameters in this datasheet were measured under the conditions of Ta=25°C, humidity<75% with nominal input voltage and rated output load;
9. All index testing methods in this datasheet are based on our Company's corporate standards;
10. The performance parameters of the product models listed in this manual are as above, but some parameters of non-standard model products may exceed the requirements mentioned above. Please contact our technicians directly for specific information;
11. We can provide product customization service;
12. Specifications are subject to change without prior notice.

MORNSUN Guangzhou Science & Technology Co., Ltd.

Address: No. 5, Kehui St. 1, Kehui Development Center, Science Ave., Guangzhou Science City, Luogang District, Guangzhou, P. R. China
Tel: 86-20-38601850-8801 Fax: 86-20-38601272 E-mail: info@mornsun.cn