



# DL35-B15852

Dx35

MID RANGE DISTANCE SENSORS

**SICK**  
Sensor Intelligence.



### Ordering information

Type	Part no.
DL35-B15852	1057658

Other models and accessories → [www.sick.com/Dx35](http://www.sick.com/Dx35)



### Detailed technical data

#### Performance

<b>Measuring range</b>	200 mm ... 35,000 mm, on reflective tape "Diamond Grade" <sup>1)</sup>
<b>Resolution</b>	0.1 mm
<b>Repeatability</b>	0.5 mm ... 5 mm <sup>2) 3) 4)</sup>
<b>Accuracy</b>	Typ. ± 15 mm <sup>3)</sup>
<b>Response time</b>	2.5 ms / 6.5 ms / 12.5 ms / 24.5 ms / 96.5 ms <sup>5) 6)</sup>
<b>Switching frequency</b>	333 Hz / 100 Hz / 50 Hz / 25 Hz / 6 Hz <sup>5) 6)</sup>
<b>Output time</b>	1 ms/2 ms/4 ms/8 ms/32 ms <sup>7) 5)</sup>
<b>Light source</b>	Laser, infrared <sup>8)</sup>
<b>Laser class</b>	1 (EN 60825-1)
<b>Typ. light spot size (distance)</b>	15 mm x 15 mm (at 2 m)
<b>Additional function</b>	Set speed: Super Fast ... Super Slow, teach-in of analog output and invertible analog output, Output Q <sub>2</sub> , selectable: 4 mA ... 20 mA / 0 V ... 10 V / switching output, Switching mode: Distance to reflective tape (DtR) / switching window (Wnd) / object between sensor and background (ObSB), teach-in of switching output and switching output invertible, IO-Link, Multifunctional input: laser off / external teach / deactivated, reset to factory default
<b>Laser service life (MTTF at 25 °C)</b>	100,000 h

<sup>1)</sup> See characteristic curves repeatability.

<sup>2)</sup> Equivalent to 1  $\sigma$ .

<sup>3)</sup> On reflective tape "Diamond Grade"

<sup>4)</sup> 6 % ... 90 % remission.

<sup>5)</sup> Depending on the set speed: Super Fast ... Super Slow.

<sup>6)</sup> Lateral entry of the object into the measuring range.

<sup>7)</sup> Continuous change of distance in measuring range.

<sup>8)</sup> Wavelength: 827 nm; max. output: 130 mW; pulse duration: 3.5 ns; duty cycle: 1/250.

## Interfaces

<b>Analog output</b>	1 x 4 mA ... 20 mA ( $\leq 450 \Omega$ ) / 1 x 0 V ... 10 V ( $\geq 50 \text{ k}\Omega$ ) / - <sup>1)</sup>
<b>Resolution analog output</b>	12 bit
<b>Switching output</b>	1 x / 2 x push-pull: PNP/NPN (100 mA), IO-Link <sup>2) 3) 4)</sup>
<b>Multifunctional input (MF)</b>	1 x <sup>5)</sup>
<b>Hysteresis</b>	0 mm ... 34,950 mm <sup>6)</sup>
<b>Data interface</b>	IO-Link

<sup>1)</sup> Output Q<sub>2</sub>, selectable: 4 mA ... 20 mA / 0 V ... 10 V / switching output.

<sup>2)</sup> Output Q short-circuit protected.

<sup>3)</sup> Voltage drop < 3 V.

<sup>4)</sup> Output Q<sub>2</sub>, adaptable: 4 mA ... 20 mA/0 V ... 10 V/switching output/Q<sub>1</sub> not/deactivated.

<sup>5)</sup> Response time  $\leq 60$  ms.

<sup>6)</sup> Configurable via IO-Link.

## Mechanics/electronics

<b>Supply voltage V<sub>s</sub></b>	DC 12 V ... 30 V <sup>1) 2)</sup>
<b>Ripple</b>	$\leq 5 V_{pp}$ <sup>3)</sup>
<b>Power consumption</b>	$\leq 1.7 \text{ W}$ <sup>4) 5)</sup>
<b>Initialization time</b>	$\leq 500$ ms
<b>Warm-up time</b>	$\leq 20$ min
<b>Housing material</b>	Plastic (ABS and PC) Acrylic glass (PMMA)
<b>Connection type</b>	Male connector, M12, 5-pin
<b>Indication</b>	LEDs
<b>Weight</b>	65 g

<sup>1)</sup> Limit values, reverse-polarity protected, operation in short-circuit protected network: max. 8 A.

<sup>2)</sup> When using IO-Link output V<sub>s</sub> > 18 V. When using analog voltage output V<sub>s</sub> > 13 V.

<sup>3)</sup> May not fall short of or exceed V<sub>s</sub> tolerances.

<sup>4)</sup> At 20 °C.

<sup>5)</sup> Without load.

## Ambient data

<b>Enclosure rating</b>	IP 65, IP 67
<b>Protection class</b>	III
<b>Ambient temperature</b>	Operation: -30 °C ... +55 °C <sup>1)</sup> Storage: -40 °C ... +75 °C
<b>Typ. Ambient light immunity</b>	40 klx
<b>Vibration resistance</b>	EN 60068-2-6 / EN 60068-2-64
<b>Shock resistance</b>	EN 60068-2-27

<sup>1)</sup> U<sub>v</sub>  $\leq 24$  V.

**Dimensional drawing** (Dimensions in mm (inch))

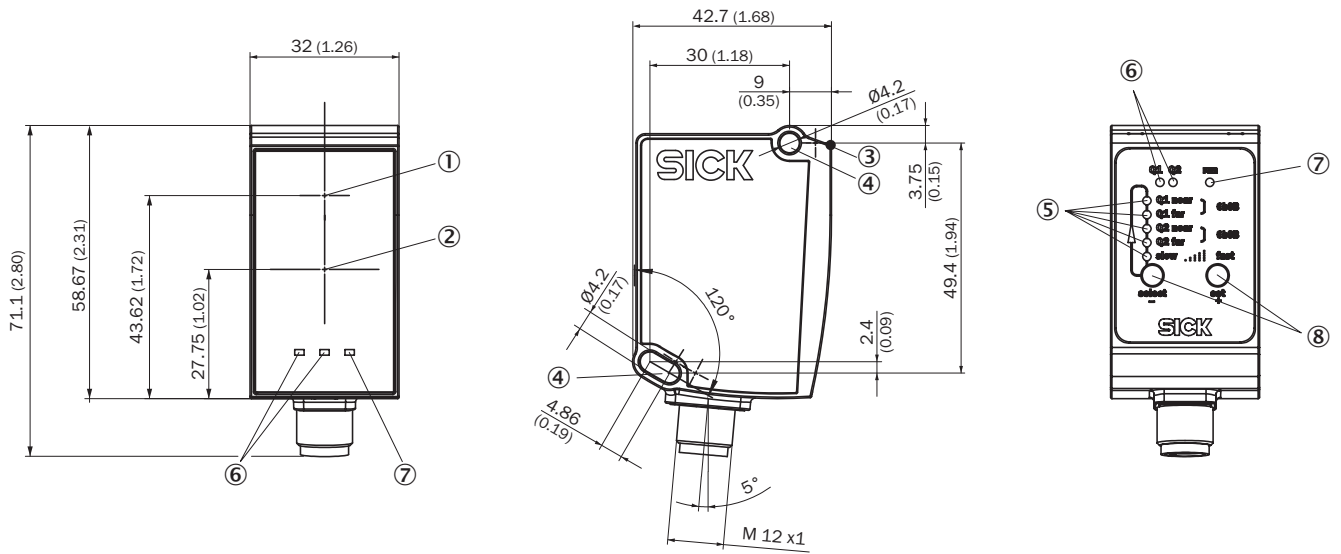

- ① Optical axis, sender
- ② Optical axis, receiver
- ③ Zero level
- ④ Mounting hole M4
- ⑤ Status indicator output Qa/Q2
- ⑥ Status LEDs output Q<sub>1</sub>
- ⑦ Operating indicator
- ⑧ Operating elements

**Connection type**

Male connector M12, 5-pin

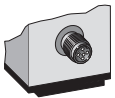

**Connection diagram**

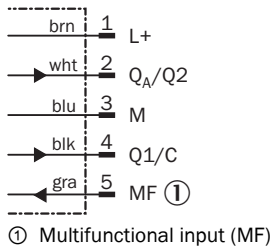

## Repeatability

DL35, DR35

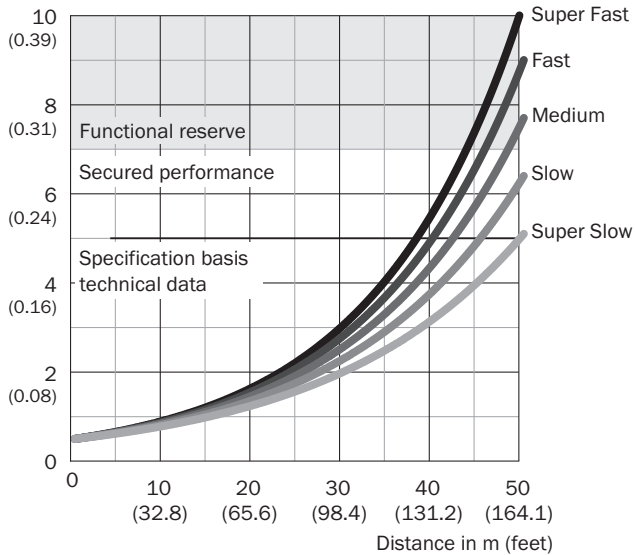

### Super Slow ... Super Fast

Repeatability in mm (inch)







## Recommended accessories

Other models and accessories → [www.sick.com/Dx35](http://www.sick.com/Dx35)

	Brief description	Type	Part no.
<b>Universal bar clamp systems</b>			
	Plate N02 for universal clamp bracket, Zinc plated steel (sheet), Zinc die cast (clamping bracket), Universal clamp (5322626), mounting hardware	BEF-KHS-N02	2051608
<b>Mounting brackets and mounting plates</b>			
	Mounting bracket: horizontal sending axis for ceiling or floor installation or vertical sending axis for wall installation, steel, zinc coated, incl. mounting material, steel, zinc coated, mounting hardware for the sensor included	BEF-WN-DX35	2069592
<b>Terminal and alignment brackets</b>			
	Alignment unit, steel, zinc coated, mounting hardware for the sensor included	BEF-AH-DX50	2048397
<b>Plug connectors and cables</b>			
	Head A: female connector, M12, 5-pin, straight Head B: cable Cable: PVC, unshielded, 2 m	DOL-1205-G02M	6008899

1) Customizable length by sheet. Width max. 74.9 cm, length max. 91.4 cm.

	Brief description	Type	Part no.
	Head A: female connector, M12, 5-pin, angled Head B: cable Cable: PVC, unshielded, 2 m	DOL-1205-W02M	6008900
	Head A: female connector, M12, 5-pin, straight, A-coded Head B: male connector, M12, 5-pin, straight, A-coded Cable: digital I/Os, drag chain use, PUR, halogen-free, unshielded, 2 m	DSL-1205-G02MC	6025931
<b>Reflectors</b>			
	Reflector plate, reflective tape "Diamond Grade", 330 mm x 330 mm, material base plate: aluminum, screw connection, Screw-on, 4 hole mounting	PL240DG	1017910
	"Diamond grade" reflective tape, self-adhesive, ready to assemble from the sheet, 74.9 cm x 91.4 cm <sup>1)</sup> , self-adhesive	REF-DG-K	4019634

<sup>1)</sup> Customizable length by sheet. Width max. 74.9 cm, length max. 91.4 cm.

## SICK AT A GLANCE

SICK is one of the leading manufacturers of intelligent sensors and sensor solutions for industrial applications. A unique range of products and services creates the perfect basis for controlling processes securely and efficiently, protecting individuals from accidents and preventing damage to the environment.

We have extensive experience in a wide range of industries and understand their processes and requirements. With intelligent sensors, we can deliver exactly what our customers need. In application centers in Europe, Asia and North America, system solutions are tested and optimized in accordance with customer specifications. All this makes us a reliable supplier and development partner.

Comprehensive services complete our offering: SICK LifeTime Services provide support throughout the machine life cycle and ensure safety and productivity.

For us, that is “Sensor Intelligence.”

## WORLDWIDE PRESENCE:

Contacts and other locations –[www.sick.com](http://www.sick.com)