

High Speed PT IGBT

POWER MOS 8® is a high speed Punch-Through switch-mode IGBT. Low E_{off} is achieved through leading technology silicon design and lifetime control processes. A reduced E_{off} - $V_{CE(ON)}$ tradeoff results in superior efficiency compared to other IGBT technologies. Low gate charge and a greatly reduced ratio of C_{res}/C_{ies} provide excellent noise immunity, short delay times and simple gate drive. The intrinsic chip gate resistance and capacitance of the poly-silicone gate structure help control di/dt during switching, resulting in low EMI, even when switching at high frequency.

APT102GA60B2

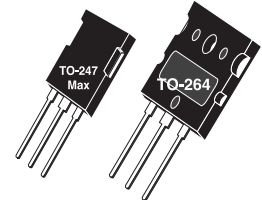

APT102GA60L



Single die IGBT

FEATURES

- Fast switching with low EMI
- Very Low E_{off} for maximum efficiency
- Ultra low C_{res} for improved noise immunity
- Low conduction loss
- Low gate charge
- Increased intrinsic gate resistance for low EMI
- RoHS compliant 

TYPICAL APPLICATIONS

- ZVS phase shifted and other full bridge
- Half bridge
- High power PFC boost
- Welding
- UPS, solar, and other inverters
- High frequency, high efficiency industrial

Absolute Maximum Ratings

Symbol	Parameter	Ratings	Unit
V_{CES}	Collector Emitter Voltage	600	V
I_{C1}	Continuous Collector Current @ $T_c = 25^\circ\text{C}$ ¹	183	A
I_{C2}	Continuous Collector Current @ $T_c = 100^\circ\text{C}$	102	
I_{CM}	Pulsed Collector Current ²	307	
V_{GE}	Gate-Emitter Voltage ³	±30	V
P_D	Total Power Dissipation @ $T_c = 25^\circ\text{C}$	780	W
SSOA	Switching Safe Operating Area @ $T_j = 150^\circ\text{C}$	307A @ 600V	
T_J, T_{STG}	Operating and Storage Junction Temperature Range	-55 to 150	°C
T_L	Lead Temperature for Soldering: 0.063" from Case for 10 Seconds	300	

Static Characteristics

 $T_J = 25^\circ\text{C}$ unless otherwise specified

Symbol	Parameter	Test Conditions	Min	Typ	Max	Unit
$V_{BR(CES)}$	Collector-Emitter Breakdown Voltage	$V_{GE} = 0V, I_C = 250\mu\text{A}$	600			V
$V_{CE(on)}$	Collector-Emitter On Voltage	$V_{GE} = 15V, I_C = 62A$ $T_J = 25^\circ\text{C}$ $T_J = 125^\circ\text{C}$		2.0 1.9	2.5	
$V_{GE(th)}$	Gate Emitter Threshold Voltage	$V_{GE} = V_{CE}, I_C = 2.5mA$	3	4.5	6	
I_{CES}	Zero Gate Voltage Collector Current	$V_{CE} = 600V, V_{GE} = 0V$ $T_J = 25^\circ\text{C}$ $T_J = 125^\circ\text{C}$			1000 5000	μA
I_{GES}	Gate-Emitter Leakage Current	$V_{GS} = \pm 30V$			±100	

Thermal and Mechanical Characteristics

Symbol	Characteristic	Min	Typ	Max	Unit
$R_{\theta JC}$	Junction to Case Thermal Resistance	-	-	0.16	°C/W
W_T	Package Weight	-	5.9	-	g
Torque	Mounting Torque (TO-247 Package), 4-40 or M3 screw			10	in·lbf

Dynamic Characteristics

T_J = 25°C unless otherwise specified

APT102GA60B2_L

Symbol	Parameter	Test Conditions	Min	Typ	Max	Unit	
C _{ies}	Input Capacitance	Capacitance V _{GE} = 0V, V _{CE} = 25V f = 1MHz		8170		pF	
C _{oes}	Output Capacitance			630			
C _{res}	Reverse Transfer Capacitance			78			
Q _g ⁴	Total Gate Charge	Gate Charge V _{GE} = 15V V _{CE} = 300V I _C = 62A		294		nC	
Q _{ge}	Gate-Emitter Charge			56			
Q _{gc}	Gate- Collector Charge			106			
SSOA	Switching Safe Operating Area	T _J = 150°C, R _G = 4.7Ω ⁵ , V _{GE} = 15V, L = 100uH, V _{CE} = 600V	307			A	
t _{d(on)}	Turn-On Delay Time	Inductive Switching (25°C) IGBT and Diode V _{CC} = 400V V _{GE} = 15V I _C = 62A R _G = 4.7Ω ⁵ T _J = +25°C		28		ns	
t _r	Current Rise Time			37			
t _{d(off)}	Turn-Off Delay Time			212			
t _f	Current Fall Time			101			
E _{on2}	Turn-On Switching Energy				1354		μJ
E _{off} ⁷	Turn-Off Switching Energy				1614		
t _{d(on)}	Turn-On Delay Time		Inductive Switching (125°C) IGBT and Diode V _{CC} = 400V V _{GE} = 15V I _C = 62A R _G = 4.7Ω ⁵ T _J = +125°C		27		ns
t _r	Current Rise Time				37		
t _{d(off)}	Turn-Off Delay Time				247		
t _f	Current Fall Time				142		
E _{on2}	Turn-On Switching Energy				2106		μJ
E _{off} ⁷	Turn-Off Switching Energy				1852		

- 1 Continuous current limited by package lead temperature.
 - 2 Repetitive Rating: Pulse width and case temperature limited by maximum junction temperature.
 - 3 Pulse test: Pulse Width < 380μs, duty cycle < 2%.
 - 4 See Mil-Std-750 Method 3471.
 - 5 R_G is external gate resistance, not including internal gate resistance or gate driver impedance. (MIC4452)
 - 6 E_{on2} is the clamped inductive turn on energy that includes a commutating diode reverse recovery current in the IGBT turn on energy loss. A combi device is used for the clamping diode.
 - 7 E_{off} is the clamped inductive turn-off energy measured in accordance with JEDEC standard JESD24-1.
- Microsemi reserves the right to change, without notice, the specifications and information contained herein.

Typical Performance Curves

APT102GA60B2_L

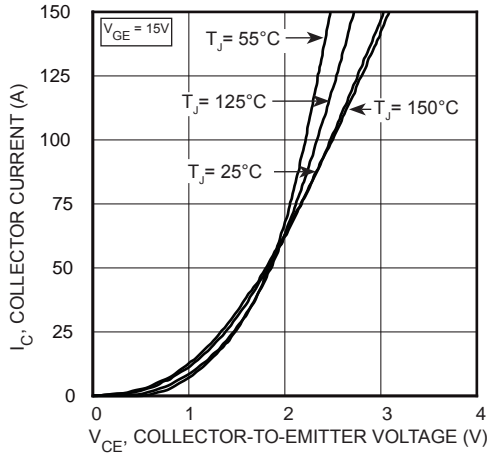

FIGURE 1, Output Characteristics ($T_J = 25^\circ\text{C}$)

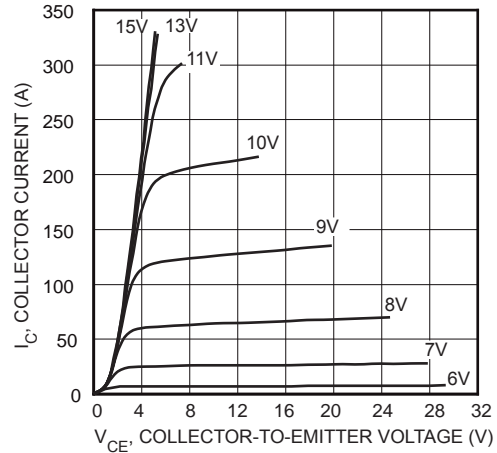

FIGURE 2, Output Characteristics ($T_J = 25^\circ\text{C}$)

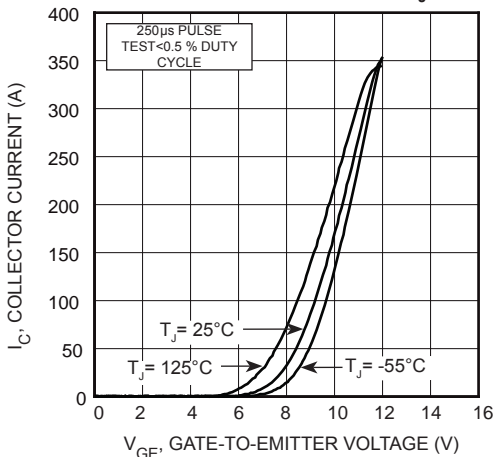

FIGURE 3, Transfer Characteristics

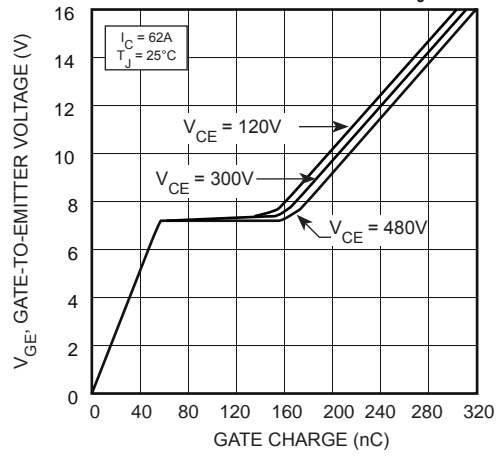

FIGURE 4, Gate charge

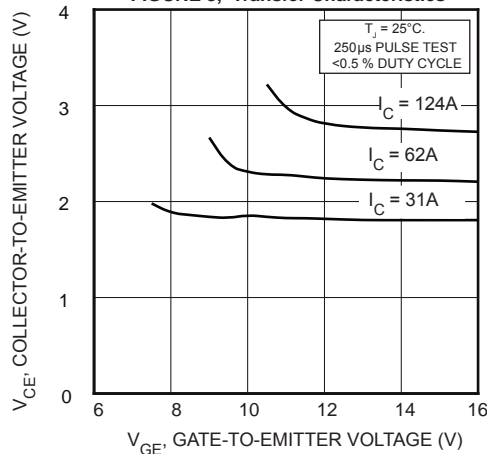

FIGURE 5, On State Voltage vs Gate-to-Emitter Voltage

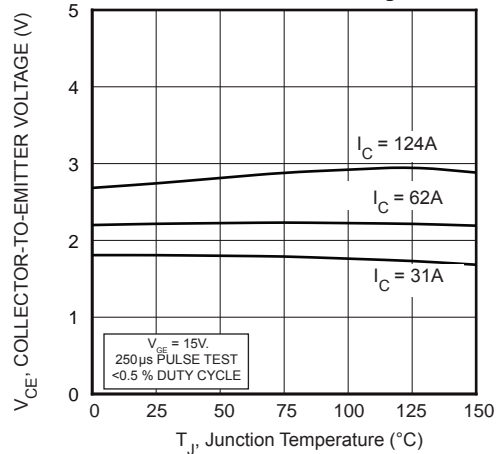

FIGURE 6, On State Voltage vs Junction Temperature

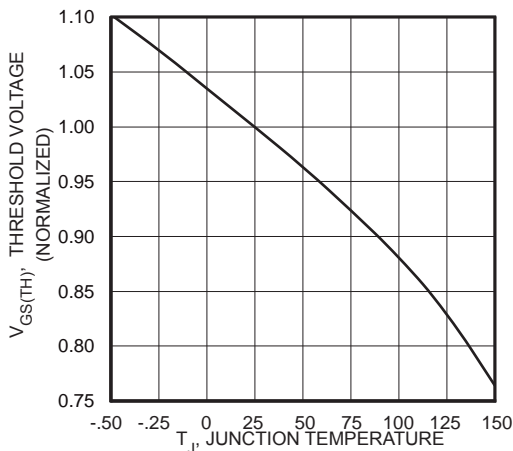

FIGURE 7, Threshold Voltage vs Junction Temperature

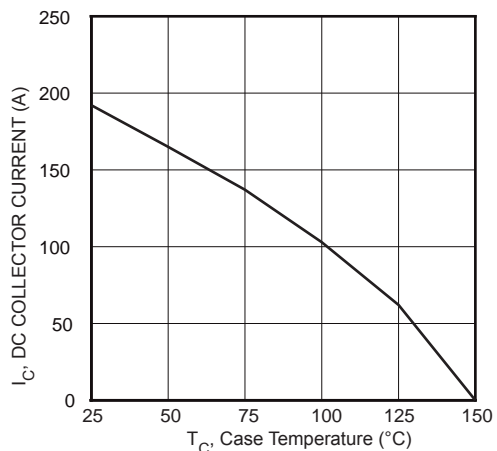

FIGURE 8, DC Collector Current vs Case Temperature

Typical Performance Curves

APT102GA60B2_L

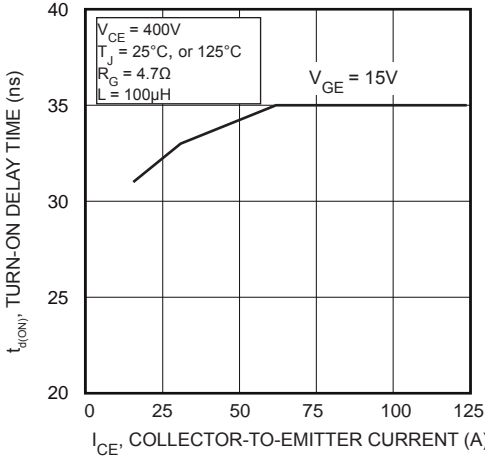

FIGURE 9, Turn-On Delay Time vs Collector Current

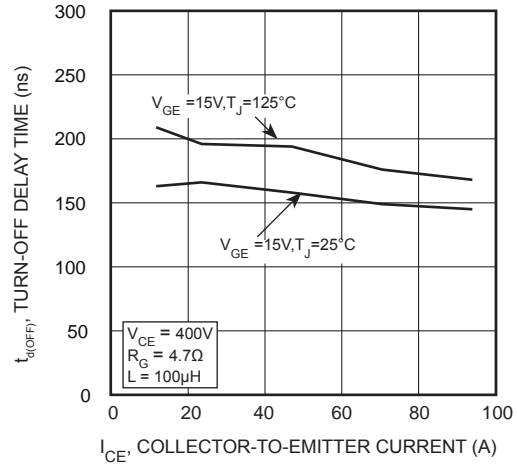

FIGURE 10, Turn-Off Delay Time vs Collector Current

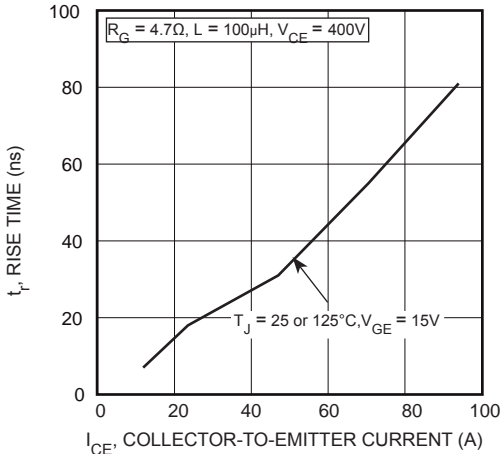

FIGURE 11, Current Rise Time vs Collector Current

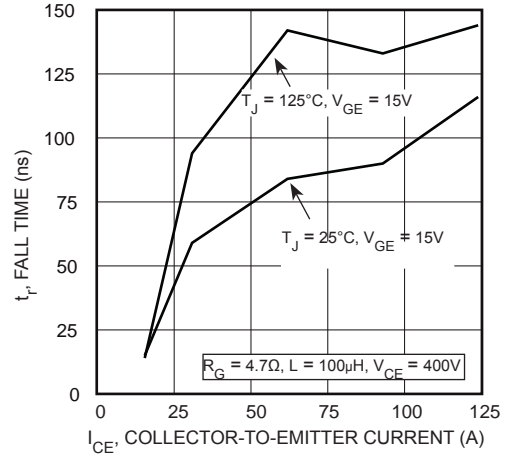

FIGURE 12, Current Fall Time vs Collector Current

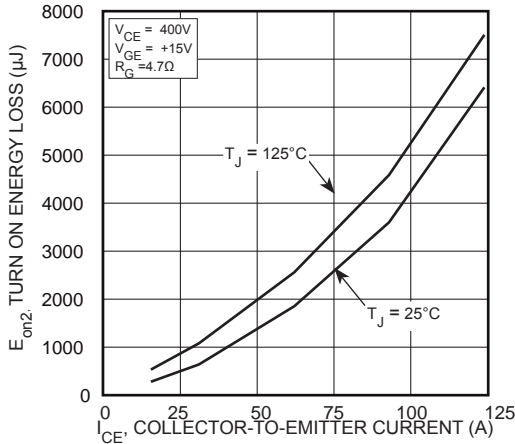

FIGURE 13, Turn-On Energy Loss vs Collector Current

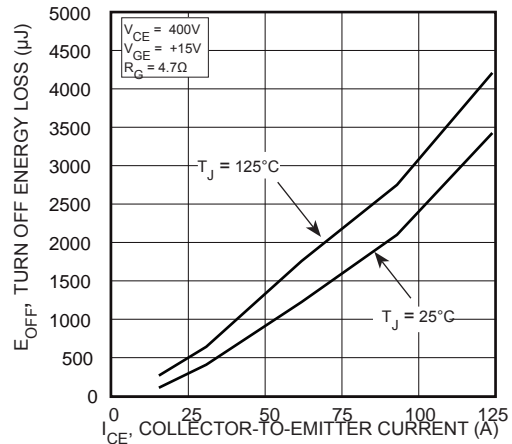

FIGURE 14, Turn-Off Energy Loss vs Collector Current

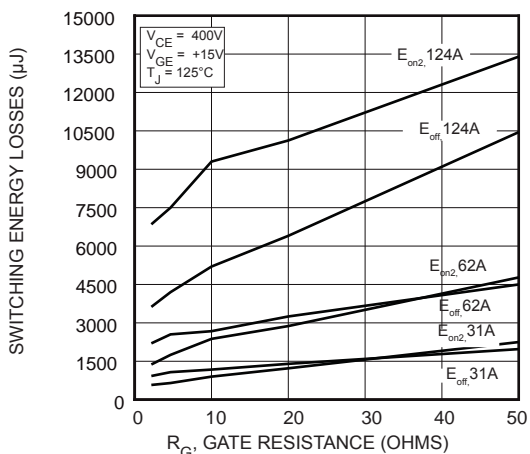

FIGURE 15, Switching Energy Losses vs Gate Resistance

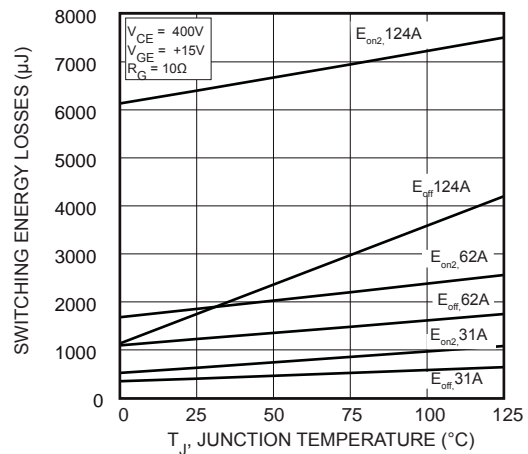

FIGURE 16, Switching Energy Losses vs Junction Temperature

Typical Performance Curves

APT102GA60B2_L

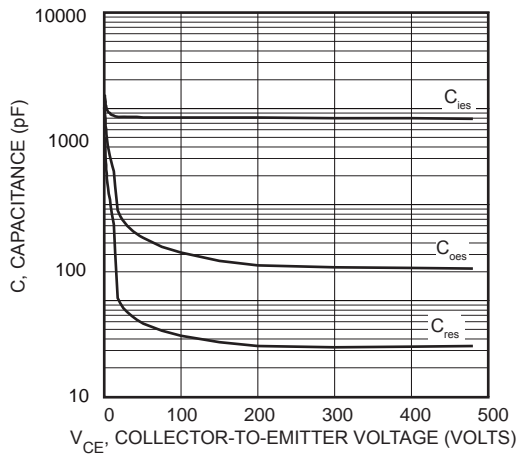

FIGURE 17, Capacitance vs Collector-To-Emitter Voltage

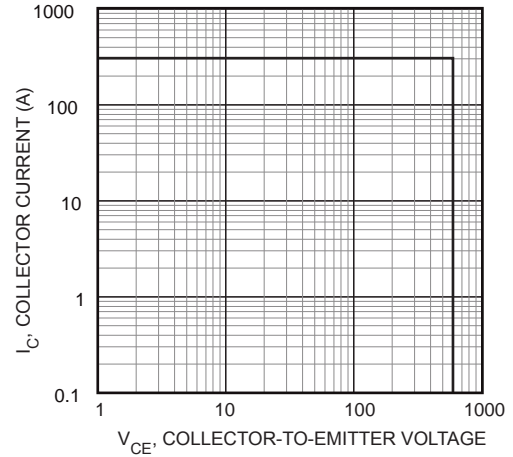

FIGURE 18, Minimum Switching Safe Operating Area

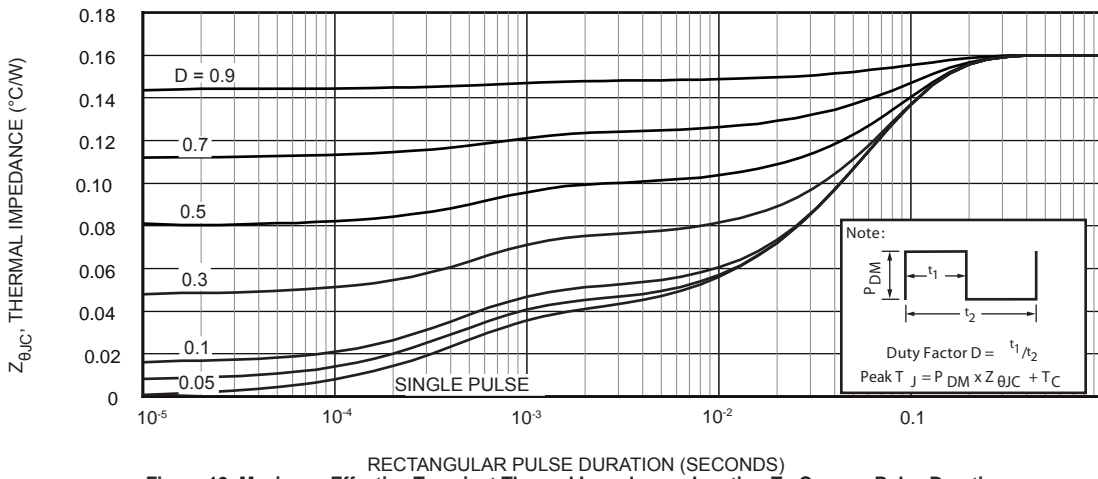

Figure 19, Maximum Effective Transient Thermal Impedance, Junction-To-Case vs Pulse Duration

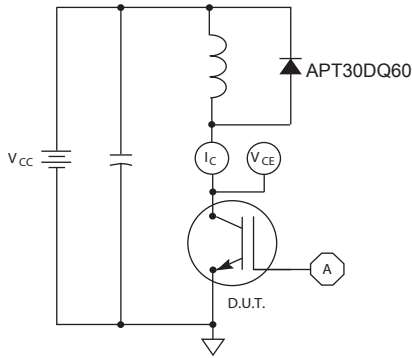

Figure 20, Inductive Switching Test Circuit

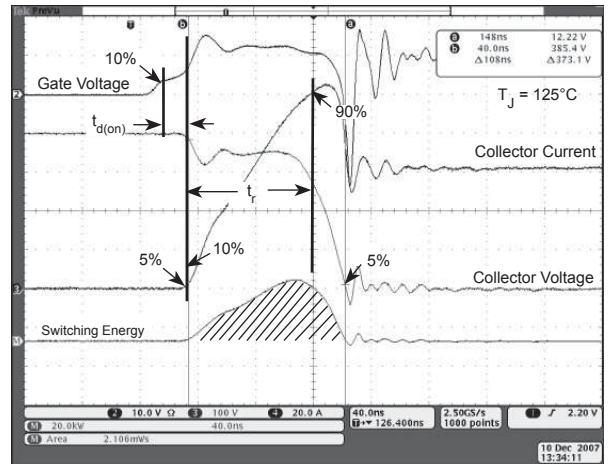

Figure 21, Turn-on Switching Waveforms and Definitions

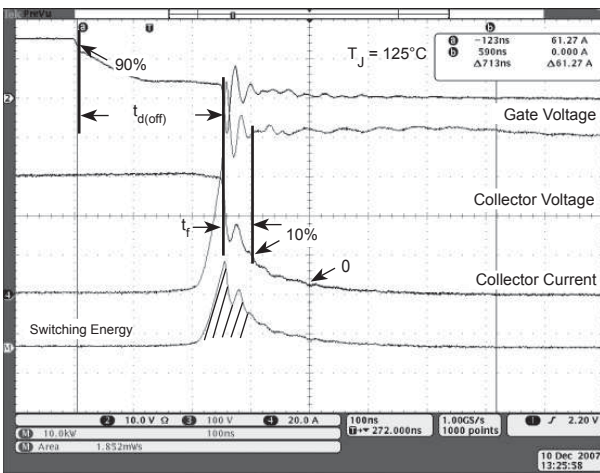
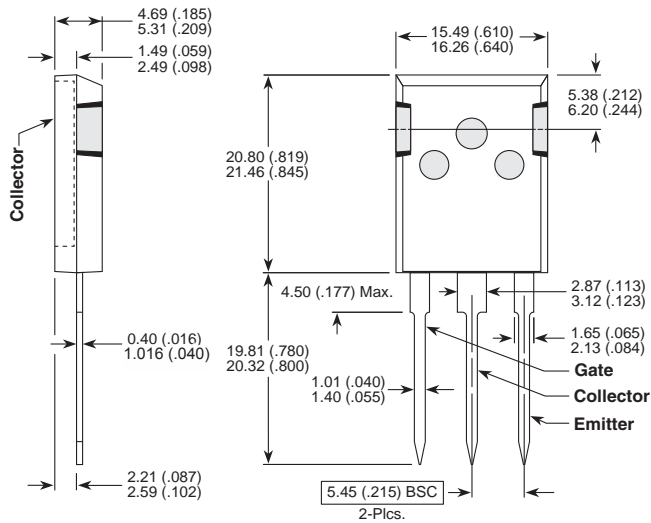

Figure 22, Turn-off Switching Waveforms and Definitions

T-MAX™ (B2) Package Outline



These dimensions are equal to the TO-247 without the mounting hole.

Dimensions in Millimeters and (Inches)

TO-264 (L) Package Outline

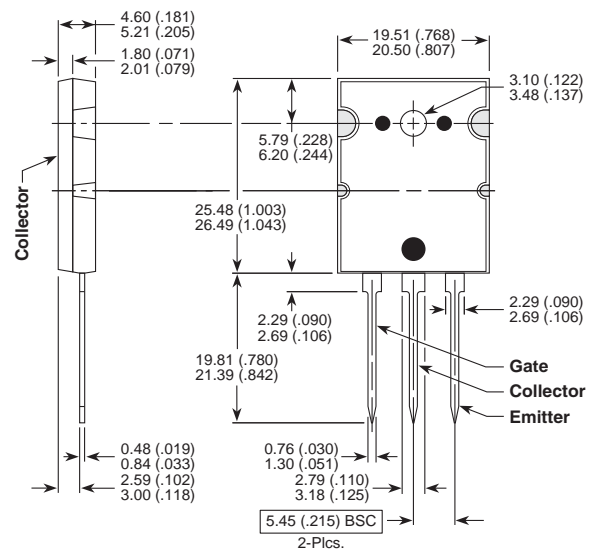

Dimensions in Millimeters and (Inches)