



POWER SUPPLY

- AC 100-240V Wide-range Input
- Width only 39mm
- Efficiency up to 94.3%, Excellent Partial Load Efficiency
- 20% Output Power Reserves
- Safe Hiccup^{PLUS} Overload Mode
- Easy Fuse Breaking due to High Overload Peak Current
- Active Power Factor Correction (PFC)
- Minimal Inrush Current Surge
- Full Power Between -25°C and +60°C
- Shut-down Input
- DC-OK Relay Contact
- Meets ITE, ATEX, Class I Div2 and SEMI F47 Requirements
- 3 Year Warranty

GENERAL DESCRIPTION

The DIMENSION CP-Series units are high-end power supplies in a medium price range without compromising quality, reliability and performance. The CP-Series is part of the DIMENSION power supply family. The most outstanding features of CP10.121 are the high efficiency, advanced inrush current limitation, active PFC and the wide operational temperature range.

The CP-Series includes all the essential basic functions. The devices have a power reserve of 20% included, which may even be used continuously at temperatures up to +45°C. Additionally, the CP10 can deliver three times the nominal output current for at least 12ms which helps to trip fuses on faulty output branches.

High immunity to transients and power surges as well as low electromagnetic emission, a shut-down input, a DC-OK relay contact and a large international approval package for a variety of applications makes this unit suitable for nearly every situation.

SHORT-FORM DATA

Output voltage	DC 12V	
Adjustment range	12 - 15V	
Output current	16A	at 12V, amb <60°C
	19.2A	at 12V, amb <45°C
	12.8A	at 15V, amb <60°C
	15.4A	at 15V, amb <45°C
Output power	192W	ambient <60°C
	230W	ambient <45°C
Output ripple	< 50mVpp	20Hz to 20MHz
AC Input voltage	AC 100-240V	-15% / +10%
Mains frequency	50-60Hz	±6%
AC Input current	1.74 / 0.92A	at 120 / 230Vac
DC Input	DC 110-150V	±20%
Power factor	0.99 / 0.96	at 120 / 230Vac
AC Inrush current	6 / 9A pk	at 40°C 120/230Vac
Efficiency	92.8 / 94.3%	at 120 / 230Vac
Losses	14.9 / 11.6W	at 120 / 230Vac
Temp. range	-25°C to +70°C	operational
Derating	4.8W/°C	+60 to +70°C
Hold-up time	50 / 50ms	at 120 / 230Vac
Dimensions	39x124x117mm	WxHxD
Weight	600g / 1.3lb	

ORDER NUMBERS

Power Supply	CP10.121	12-15V Standard unit
Accessory	ZM12.SIDE YR40.242	Side mount bracket Redundancy module

MARKINGS



EMC, LVD, ATEX



Marine, planned

INDEX

	Page		Page
1. Intended Use	3	21. RoHS, REACH and Other Fulfilled Standards ..	17
2. Installation Requirements.....	3	22. Physical Dimensions and Weight	18
3. AC-Input.....	4	23. Accessories	19
4. DC-Input.....	5	23.1. ZM12.SIDE - Side Mounting Bracket.....	19
5. Input Inrush Current	5	23.2. Redundancy Module	20
6. Output	6	24. Application Notes.....	21
7. Hold-up Time.....	7	24.1. Peak Current Capability	21
8. DC-OK Relay Contact	8	24.2. Back-feeding Loads	22
9. Shut-down Input	8	24.3. External Input Protection.....	22
10. Efficiency and Power Losses.....	9	24.4. Output Circuit Breakers.....	22
11. Lifetime Expectancy and MTBF.....	10	24.5. Parallel Use to Increase Output Power....	23
12. Functional Diagram.....	10	24.6. Parallel Use for Redundancy	23
13. Terminals and Wiring.....	11	24.7. Series Operation	24
14. Front Side and User Elements.....	12	24.8. Inductive and Capacitive Loads.....	24
15. EMC.....	13	24.9. Charging of Batteries	24
16. Environment.....	14	24.10. Operation on Two Phases	25
17. Protection Features	15	24.11. Use in a Tightly Sealed Enclosure	25
18. Safety Features	15	24.12. Mounting Orientations	26
19. Dielectric Strength	16		
20. Approvals.....	17		

The information presented in this document is believed to be accurate and reliable and may change without notice. No part of this document may be reproduced or utilized in any form without permission in writing from the publisher.

TERMINOLOGY AND ABBREVIATIONS

PE and \oplus symbol	PE is the abbreviation for Protective Earth and has the same meaning as the symbol \oplus .
Earth, Ground	This document uses the term "earth" which is the same as the U.S. term "ground".
T.b.d.	To be defined, value or description will follow later.
AC 230V	A figure displayed with the AC or DC before the value represents a nominal voltage with standard tolerances (usually $\pm 15\%$) included. E.g.: DC 12V describes a 12V battery disregarding whether it is full (13.7V) or flat (10V)
230Vac	A figure with the unit (Vac) at the end is a momentary figure without any additional tolerances included.
50Hz vs. 60Hz	As long as not otherwise stated, AC 100V and AC 230V parameters are valid at 50Hz mains frequency. AC 120V parameters are valid for 60Hz mains frequency.
may	A key word indicating flexibility of choice with no implied preference.
shall	A key word indicating a mandatory requirement.
should	A key word indicating flexibility of choice with a strongly preferred implementation.

1. INTENDED USE

This device is designed for installation in an enclosure and is intended for the general professional use such as in industrial control, office, communication, and instrumentation equipment.

Do not use this power supply in equipment, where malfunction may cause severe personal injury or threaten human life.

2. INSTALLATION REQUIREMENTS

This device may only be installed and put into operation by qualified personnel.

This device does not contain serviceable parts. The tripping of an internal fuse is caused by an internal defect.

If damage or malfunction should occur during installation or operation, immediately turn power off and send unit to the factory for inspection.

Mount the unit on a DIN-rail so that the terminals are located on the bottom of the unit. For other mounting orientations see de-rating requirements in this document. See chapter 24.12.

This device is designed for convection cooling and does not require an external fan. Do not obstruct airflow and do not cover ventilation grid (e.g. cable conduits) by more than 15%!

Keep the following installation clearances: 40mm on top, 20mm on the bottom, 5mm on the left and right sides are recommended when the device is loaded permanently with more than 50% of the rated power. Increase this clearance to 15mm in case the adjacent device is a heat source (e.g. another power supply).

A disconnecting means shall be provided for the output of the power supplies when used in applications according to CSA C22.2 No 107.1-01.

 **WARNING** Risk of electrical shock, fire, personal injury or death.

- Do not use the power supply without proper grounding (Protective Earth). Use the terminal on the input block for earth connection and not one of the screws on the housing.
- Turn power off before working on the device. Protect against inadvertent re-powering.
- Make sure that the wiring is correct by following all local and national codes.
- Do not modify or repair the unit.
- Do not open the unit as high voltages are present inside.
- Use caution to prevent any foreign objects from entering the housing.
- Do not use in wet locations or in areas where moisture or condensation can be expected.
- Do not touch during power-on, and immediately after power-off. Hot surfaces may cause burns.

Notes for use in hazardous location areas:

The power supply is suitable for use in Class I Division 2 Groups A, B, C, D locations and for use in Group II Category 3 (Zone 2) environments and are evaluated according to EN 60079-0:2012 and EN 60079-15:2010.

WARNING EXPLOSION HAZARDS!

Substitution of components may impair suitability for this environment. Do not disconnect the unit or operate the voltage adjustment or S/P jumper unless power has been switched off or the area is known to be non-hazardous.

A suitable enclosure must be provided for the end product which has a minimum protection of IP54 and fulfils the requirements of the EN 60079-15:2010.

3. AC-INPUT

AC input	nom.	AC 100-240V	suitable for TN-, TT- and IT mains networks
AC input range	min.	85-264Vac	continuous operation
	min.	264-300Vac	< 500ms
Allowed voltage L or N to earth	max.	300Vac	continuous, IEC 62103
Input frequency	nom.	50-60Hz	±6%
Turn-on voltage	typ.	80Vac	steady-state value, see Fig. 3-1
	typ.	55Vac	dynamic value (250ms)
Shut-down voltage	typ.	70Vac	steady-state value, see Fig. 3-1
External input protection	See recommendations in chapter 24.3.		

		AC 100V	AC 120V	AC 230V	
Input current	typ.	2.11A	1.74A	0.92A	at 12V, 16A, see Fig. 3-3
Power factor*)	typ.	0.99	0.99	0.96	at 12V, 16A, see Fig. 3-4
Crest factor**)	typ.	1.5	1.5	1.65	at 12V, 16A
Start-up delay	typ.	300ms	290ms	240ms	see Fig. 3-2
Rise time	typ.	18ms	18ms	18ms	at 12V, 16A const. current load, 0mF load capacitance, see Fig. 3-2
	typ.	35ms	35ms	35ms	at 12V, 16A const. current load, 16mF load capacitance,, see Fig. 3-2
Turn-on overshoot	max.	200mV	200mV	200mV	see Fig. 3-2
External input protection	See recommendations in chapter 24.3.				

*) The power factor is the ratio of the true (or real) power to the apparent power in an AC circuit.

***) The crest factor is the mathematical ratio of the peak value to RMS value of the input current waveform.

Fig. 3-1 **Input voltage range**

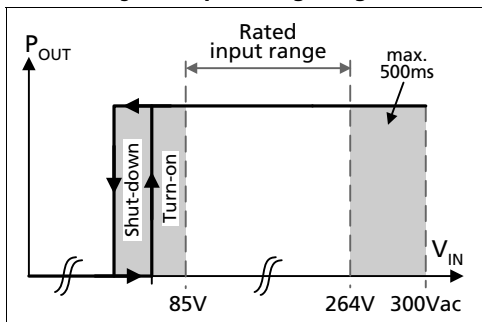

Fig. 3-3 **Input current vs. output current at 12V output voltage**

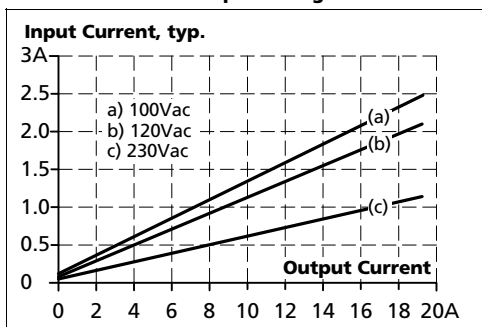

Fig. 3-2 **Turn-on behavior, definitions**

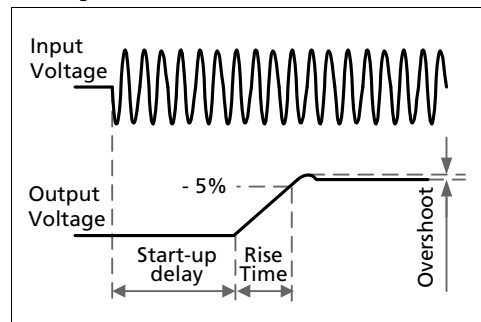
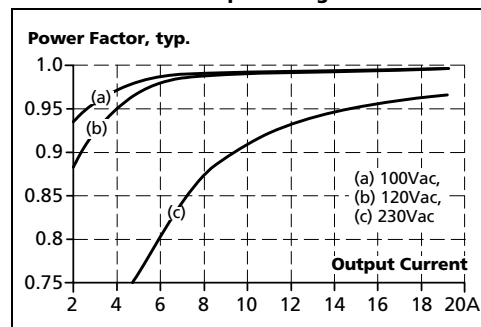

Fig. 3-4 **Power factor vs. output current at 12V output voltage**



4. DC-INPUT

DC input	nom.	DC 110-150V	±20%
DC input range	min.	88-187Vdc	continuous operation
DC input current	typ.	1.9A	110Vdc, at 12V, 16A
Allowed Voltage L/N to Earth	max.	375Vdc	continuous, IEC 62103
Turn-on voltage	typ.	80Vdc	steady state value
Shut-down voltage	typ.	70Vdc	steady state value

Fig. 4-1 **Wiring for DC Input**

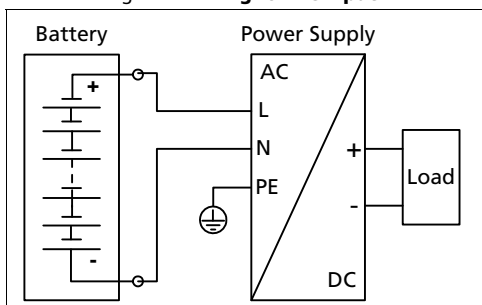

Instructions for DC use:

- Use a battery or a similar DC source. A supply from the intermediate DC-bus of a frequency converter is not recommended and can cause a malfunction or damage the unit.
- Connect +pole to L and -pole to N.
- Connect the PE terminal to an earth wire or to the machine ground.

5. INPUT INRUSH CURRENT

An active inrush limitation circuit (NTCs, which are bypassed by a relay contact) limits the input inrush current after turn-on of the input voltage.

The charging current into EMI suppression capacitors is disregarded in the first microseconds after switch-on.

		AC 100V	AC 120V	AC 230V	
Inrush current	max.	11A _{peak}	7A _{peak}	11A _{peak}	at 40°C, cold start
	typ.	9A _{peak}	6A _{peak}	6A _{peak}	at 25°C, cold start
	typ.	9A _{peak}	6A _{peak}	9A _{peak}	at 40°C, cold start
Inrush energy	max.	0.1A ² s	0.1A ² s	0.4A ² s	at 40°C, cold start

Fig. 5-1 **Typical turn-on behaviour at nominal load, 120Vac input and 25°C ambient**

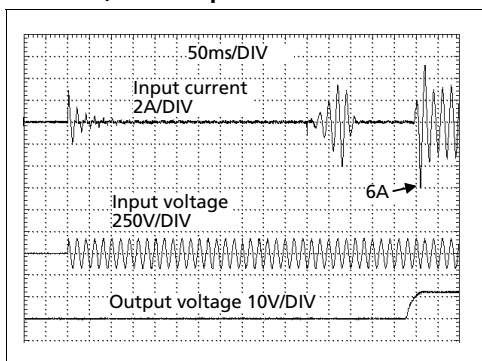
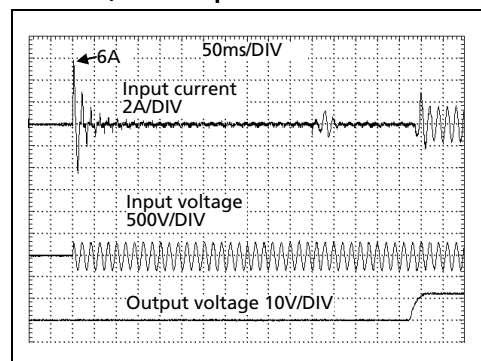

Fig. 5-2 **Typical turn-on behaviour at nominal load, 230Vac input and 25°C ambient**



6. OUTPUT

Output voltage	nom.	12V	
Adjustment range	min.	12-15V	guaranteed
	max.	16.5V ^{****)}	at clockwise end position of potentiometer
Factory settings	typ.	12.0V	±0.2%, at full load and cold unit
Line regulation	max.	10mV	85-300Vac
Load regulation	max.	50mV	static value, 0A → 16A; see Fig. 6-1
Ripple and noise voltage	max.	50mVpp	20Hz to 20MHz, 50Ohm
Output current	nom.	16A	at 12V, ambient temperature <60°C, see Fig. 6-1
	nom.	19.2A ^{*)}	at 12V, ambient temperature <45°C, see Fig. 16-1
	nom.	12A	at 12V and 70°C ambient temperature, see Fig. 16-1
	nom.	12.8A	at 15V, ambient temperature <60°C, see Fig. 6-1
	nom.	15.4A ^{*)}	at 15V, ambient temperature <45°C, see Fig. 16-1
	nom.	9.6A	at 15V and 70°C ambient temperature, see Fig. 16-1
	typ.	48A	up to at least 12ms ^{****)} , output voltage stays above 10V, see Fig. 6-2 and Fig. 24-3, This peak current is available once every five seconds (hardware controlled).
Output power	nom.	192W	continuously available
	nom.	230W ^{*)}	Power Boost ^{*)}
Overload behaviour		cont. current	output voltage > 6.5Vdc, see Fig. 6-1
		Hiccup ^{PLUS} mode ^{**)}	output voltage < 6.5Vdc, see Fig. 6-1
Short-circuit current	min.	22.5A ^{***)}	load impedance <30mOhm, see Fig. 6-3
	max.	27.5A ^{***)}	load impedance <30mOhm, see Fig. 6-3
	max.	7.9A	average (R.M.S.) current, load impedance 50mOhm, see Fig. 6-3
		min.	50A
	typ.	55A	up to 12ms, load impedance <30mOhm, see Fig. 6-2
Output capacitance	typ.	5 350µF	included inside the power supply

***) Power Boost**

This power/ current is continuously allowed up to an ambient temperature of 45°C.

Above 45°C, do not use this power/ current longer than a duty cycle of 10% and/ or not longer than 1 minute every 10 minutes.

*****) Hiccup^{PLUS} Mode**

At heavy overloads (when output voltage falls below 6.5V), the power supply delivers continuous output current for 2s. After this, the output is switched off for approx. 18s before a new start attempt is automatically performed. This cycle is repeated as long as the overload exists. If the overload has been cleared, the device will operate normally. See Fig. 6-3

******) Discharge current of output capacitors is not included.**

*******) This is the maximum output voltage which can occur at the clockwise end position of the potentiometer due to tolerances. It is not a guaranteed value which can be achieved. The typical value is about 15.5V.**

*******) Reduced pulse length for AC 100V mains.**

Fig. 6-1 **Output voltage vs. output current, typ.**

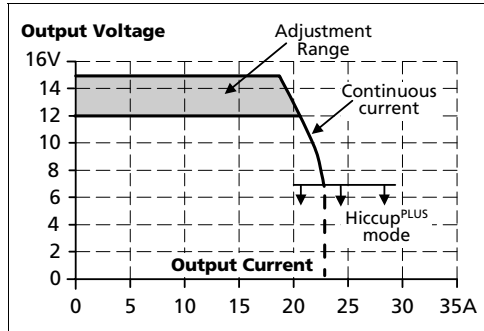

Fig. 6-2 **Dynamic output current capability, typ.**

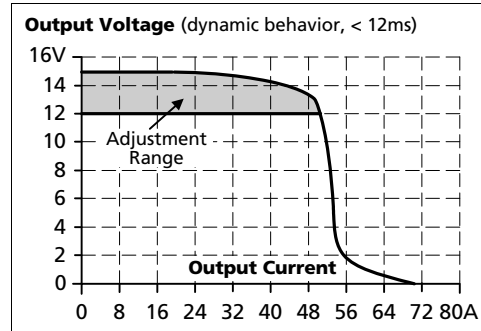
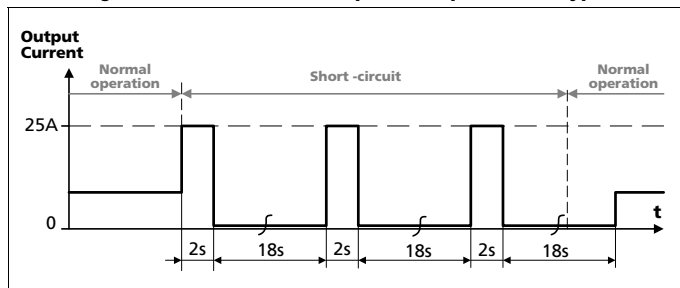

Fig. 6-3 **Short-circuit on output, Hiccup^{PLUS} mode, typ.**



7. HOLD-UP TIME

		AC 100V	AC 120V	AC 230V	
Hold-up Time	typ.	108ms	108ms	108ms	at 12V, 8A, see Fig. 7-1
	min.	81ms	81ms	81ms	at 12V, 8A, see Fig. 7-1
	typ.	50ms	50ms	50ms	at 12V, 16A, see Fig. 7-1
	min.	38ms	38ms	38ms	at 12V, 16A, see Fig. 7-1

Fig. 7-1 **Hold-up time vs. input voltage**

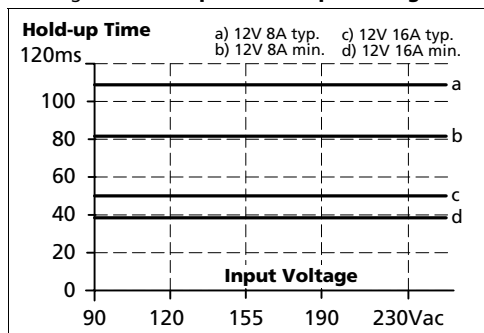
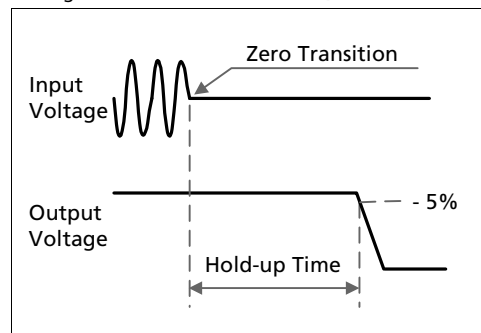

Fig. 7-2 **Shut-down behavior, definitions**



8. DC-OK RELAY CONTACT

This feature monitors the output voltage on the output terminals of a running power supply.

Contact closes	As soon as the output voltage reaches typ. 90% of the adjusted output voltage level.	
Contact opens	As soon as the output voltage dips more than 10% below the adjusted output voltage. Short dips will be extended to a signal length of 100ms. Dips shorter than 1ms will be ignored.	
Contact ratings	max. 60Vdc 0.3A, 30Vdc 1A, 30Vac 0.5A	resistive load
	min. 1mA at 5Vdc	min. permissible load
Isolation voltage	See dielectric strength table in section 18.	

Fig. 8-1 DC-ok relay contact behavior

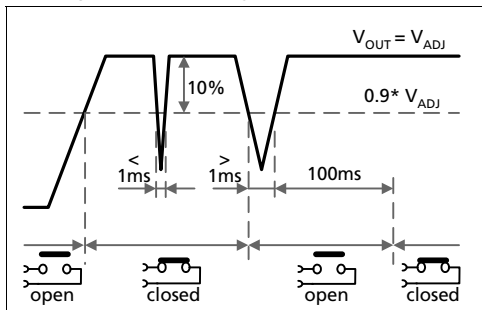

9. SHUT-DOWN INPUT

This feature allows to switch-off the power supply output with a signal switch or transistor.

A link between pin 15 and 16 turns the power supply off.

Pin 15 is referenced to the (-) output voltage.

The open-loop voltage between pin 16 and pin 15 can be up to 18V, the maximum current, when activating the shut-down, can be up to 2.5mA.

The threshold level to switch-off the output is typically 5V and the turn-on threshold is typically 9V.

When multiple power supplies are connected in parallel, pin 15 and pin 16 are also allowed to be paralleled to control all units with the same switch or transistor.

Please note: The shut-down function has no safety feature included.

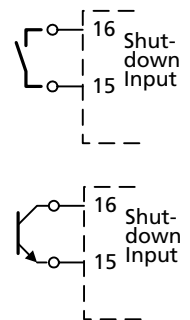
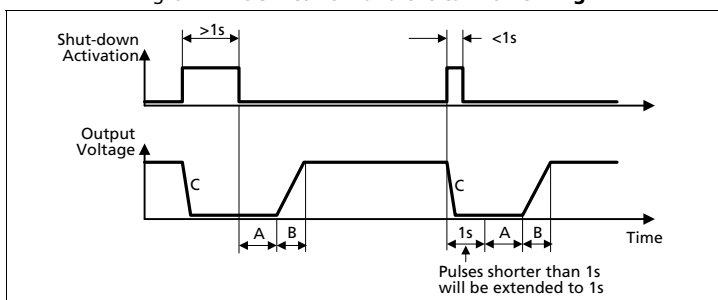

Fig. 9-1 The switch-off and the turn-on timing



- A:** Turn-on delay acc. Fig. 3-2
- B:** Rise time acc. Fig. 3-2
- C:** No active discharge of the output after switch-off

10. EFFICIENCY AND POWER LOSSES

		AC 100V	AC 120V	AC 230V	
Efficiency	typ.	92.1%	92.8%	94.3%	at 12V, 16A
	typ.	92.0%	92.7%	94.2%	at 12V, 19.2A (Power Boost)
Average efficiency*)	typ.	91.6%	92.2%	93.3%	25% at 4A, 25% at 8A, 25% at 12A. 25% at 16A
Power losses	typ.	0.5W	0.5W	0.6W	Shut-down activated
	typ.	3.1W	3.0W	2.5W	at 12V, 0A
	typ.	8.0W	7.8W	6.7W	at 12V, 8A
	typ.	16.5W	14.9W	11.6W	at 12V, 16A
	typ.	20.0W	18.1W	13.9W	at 12V, 19.2A (Power Boost)

*) The average efficiency is an assumption for a typical application where the power supply is loaded with 25% of the nominal load for 25% of the time, 50% of the nominal load for another 25% of the time, 75% of the nominal load for another 25% of the time and with 100% of the nominal load for the rest of the time.

**) In OFF mode, the unit fulfills the ErP requirements of the European Union.

Fig. 10-1 Efficiency vs. output current at 12V, typ.

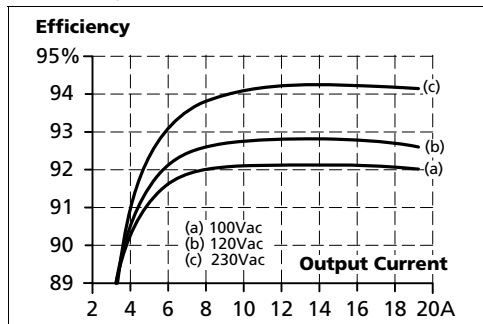

Fig. 10-2 Losses vs. output current at 12V, typ.

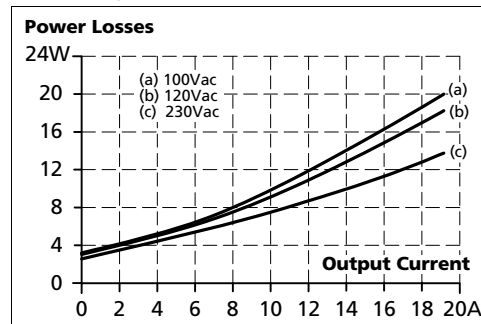

Fig. 10-3 Efficiency vs. input voltage at 12V, 16A, typ.

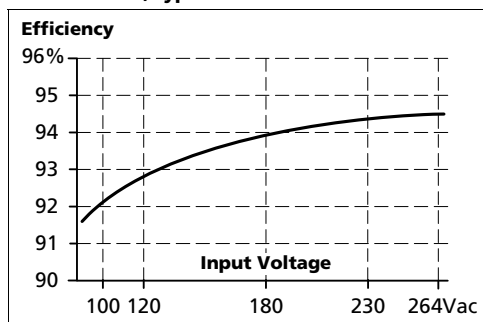
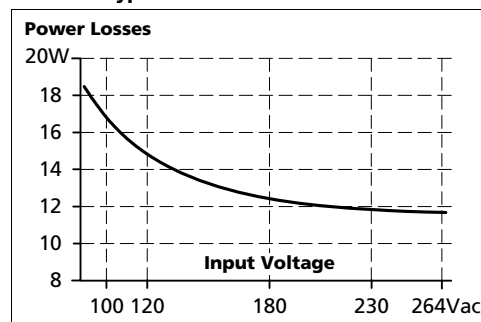

Fig. 10-4 Losses vs. input voltage at 12V, 16A, typ.



11. LIFETIME EXPECTANCY AND MTBF

	AC 100V	AC 120V	AC 230V	
Lifetime expectancy*)	155 000h *)	176 000h *)	189 000h *)	at 12V, 8A and 40°C
	437 000h *)	499 000h *)	534 000h *)	at 12V, 8A and 25°C
	66 000h	75 000h	97 000h	at 12V, 16A and 40°C
	188 000h *)	213 000h *)	275 000h *)	at 12V, 16A and 25°C
	33 000h	40 000h	57 000h	at 12V, 19.2A and 40°C
	94 000h	112 000h	160 000h *)	at 12V, 19.2A and 25°C
MTBF**) SN 29500, IEC 61709	587 000h	607 000h	690 000h	at 12V, 16A and 40°C
	1 025 000h	1 056 000h	1 185 000h	at 12V, 16A and 25°C
MTBF**) MIL HDBK 217F	246 000h	249 000h	278 000h	at 12V, 16A and 40°C; Ground Benign GB40
	333 000h	337 000h	381 000h	at 12V, 16A and 25°C; Ground Benign GB25
	55 000h	55 000h	64 000h	at 12V, 16A and 40°C; Ground Fixed GF40
	70 000h	71 000h	83 000h	at 12V, 16A and 25°C; Ground Fixed GF25

- *) The **Lifetime expectancy** shown in the table indicates the minimum operating hours (service life) and is determined by the lifetime expectancy of the built-in electrolytic capacitors. Lifetime expectancy is specified in operational hours and is calculated according to the capacitor's manufacturer specification. The manufacturer of the electrolytic capacitors only guarantees a maximum life of up to 15 years (131 400h). Any number exceeding this value is a calculated theoretical lifetime which can be used to compare devices.
- **) **MTBF** stands for **Mean Time Between Failure**, which is calculated according to statistical device failures, and indicates reliability of a device. It is the statistical representation of the likelihood of a unit to fail and does not necessarily represent the life of a product. The MTBF figure is a statistical representation of the likelihood of a device to fail. A MTBF figure of e.g. 1 000 000h means that statistically one unit will fail every 100 hours if 10 000 units are installed in the field. However, it cannot be determined if the failed unit has been running for 50 000h or only for 100h.

12. FUNCTIONAL DIAGRAM

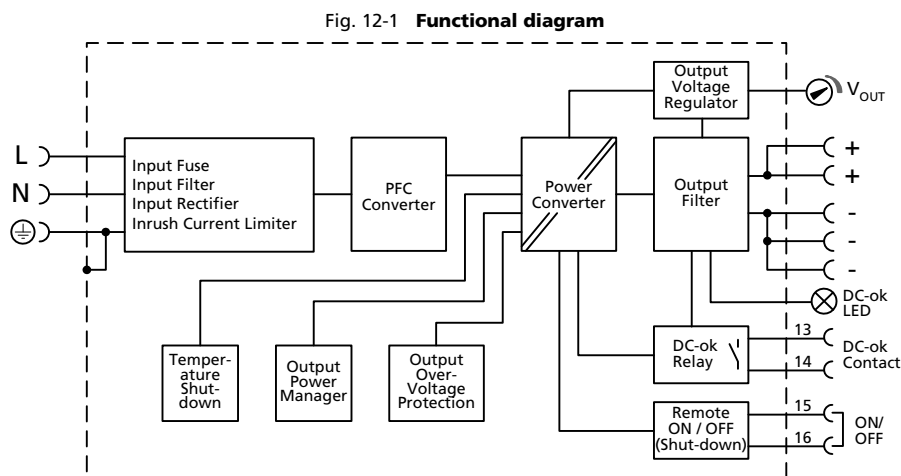

13. TERMINALS AND WIRING

The terminals are IP20 finger safe constructed and suitable for field- and factory wiring.

Type	Input and output screw terminals	DC-OK-Signal, Shut-down input push-in terminals
Solid wire	max. 6mm ²	max. 1.5mm ²
Stranded wire	max. 4mm ²	max. 1.5mm ²
American Wire Gauge	AWG20-10	AWG28-16
Wire diameter	max. 2.8mm (including ferrules)	max. 1.6mm (including ferrules)
Wire stripping length	7mm / 0.28inch	7mm / 0.28inch
Screwdriver	3.5mm slotted or cross-head No 2	not required
Recommended tightening torque	1Nm, 9lb.in	not applicable

Instructions:

- Use appropriate copper cables that are designed for minimum operating temperatures of:
60°C for ambient up to 45°C and
75°C for ambient up to 60°C minimum
90°C for ambient up to 70°C minimum.
- Follow national installation codes and installation regulations!
- Ensure that all strands of a stranded wire enter the terminal connection!
- Do not use the unit without PE connection.
- Unused terminal compartments should be securely tightened.
- Ferrules are allowed.

Daisy chaining:

Daisy chaining (jumping from one power supply output to the next) is allowed as long as the average output current through one terminal pin does not exceed 25A. If the current is higher, use a separate distribution terminal block as shown in Fig. 13-2.

Fig. 13-1 Daisy chaining of outputs

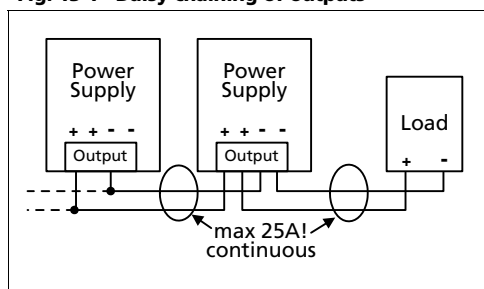
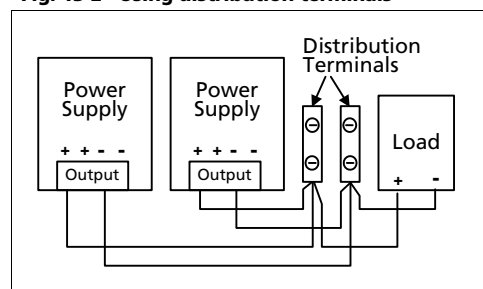

Fig. 13-2 Using distribution terminals



14. FRONT SIDE AND USER ELEMENTS

Fig. 14-1
Front side



- A Input Terminals** (screw terminal)
 - N, L** Line input
 - ⊕ PE (Protective Earth) input
- B Output Terminals** (screw terminal, two identical + poles and three identical - poles)
 - + Positive output
 - Negative (return) output
- C Output voltage potentiometer**
Open the flap to adjust the output voltage. Factory set: 12.0V
- D DC-OK LED** (green)
On, when the output voltage is >90% of the adjusted output voltage
- E DC-OK Relay Contact** (quick-connect spring-clamp terminals)
Monitors the output voltage of the running power supply.
See chapter 8 for details.
- F Shut-down Input** (quick-connect spring-clamp terminals)
Pin 15 and 16 must be connected to turn the power supply off.
See chapter 9 for details.

15. EMC

The power supply is suitable for applications in industrial environment as well as in residential, commercial and light industry environment without any restrictions.

EMC Immunity		According generic standards: EN 61000-6-1 and EN 61000-6-2		
Electrostatic discharge	EN 61000-4-2	contact discharge	8kV	Criterion A
		air discharge	15kV	Criterion A
Electromagnetic RF field	EN 61000-4-3	80MHz-2.7GHz	20V/m	Criterion A
Fast transients (Burst)	EN 61000-4-4	input lines	4kV	Criterion A
		output lines	2kV	Criterion A
		DC-OK signal (coupling clamp)	2kV	Criterion A
		Shut-down input	2kV	Criterion A
Surge voltage on input	EN 61000-4-5	L → N	2kV	Criterion A
		L → PE, N → PE	4kV	Criterion A
Surge voltage on output	EN 61000-4-5	+ → -	1kV	Criterion A
		+ / - → PE	2kV	Criterion A
Surge voltage on Signals	EN 61000-4-5	DC-OK signal → PE	1kV	Criterion A
		Shut-down input → PE	1kV	Criterion A
Conducted disturbance	EN 61000-4-6	0.15-80MHz	20V	Criterion A
Mains voltage dips	EN 61000-4-11	0% of 100Vac	0Vac, 20ms	Criterion A
		40% of 100Vac	40Vac, 200ms	Criterion C
		70% of 100Vac	70Vac, 500ms	Criterion C
		0% of 200Vac	0Vac, 20ms	Criterion A
		40% of 200Vac	80Vac, 200ms	Criterion A
		70% of 200Vac	140Vac, 500ms	Criterion A
Voltage interruptions	EN 61000-4-11	0% of 200Vac (=0V)	5000ms	Criterion C
		Voltage sags		
Voltage sags	SEMI F47 0706	dips on the input voltage according to SEMI F47 standard		
		80% of 120Vac (96Vac)	1000ms	Criterion A
		70% of 120Vac (84Vac)	500ms	Criterion A
		50% of 120Vac (60Vac)	200ms	Criterion A
Powerful transients	VDE 0160	over entire load range	750V, 0.3ms	Criterion A

Criteria:

- A:** Power supply shows normal operation behavior within the defined limits.
- C:** Temporary loss of function is possible. Power supply may shut-down and restarts by itself. No damage or hazards for the power supply will occur.

EMC Emission		According generic standards: EN 61000-6-3 and EN 61000-6-4	
Conducted emission input lines	EN 55011, EN 55015, EN 55022, FCC Part 15, CISPR 11, CISPR 22	Class B	
Conducted emission output lines**)	IEC/CISPR 16-1-2, IEC/CISPR 16-2-1	limits for DC power port according EN 61000-6-3 fulfilled	
Radiated emission	EN 55011, EN 55022	Class B	
Harmonic input current	EN 61000-3-2	Class A fulfilled between 0A and 19.2A load	
		Class C fulfilled between 10A and 19.2A load	
Voltage fluctuations, flicker	EN 61000-3-3	fulfilled*)	

This device complies with FCC Part 15 rules.

Operation is subjected to following two conditions: (1) this device may not cause harmful interference, and (2) this device must accept any interference received, including interference that may cause undesired operation.

- *) tested with constant current loads, non pulsing
- **) for information only, not mandatory for EN 61000-6-3

Switching Frequencies	The power supply has three converters with two different switching frequencies included.	
Switching frequency 1	110kHz	PFC converter, input voltage and output power dependent
Switching frequency 2	110kHz to 140kHz	Main converter, output power dependent
Switching frequency 3	60kHz	Auxiliary converter

16. ENVIRONMENT

Operational temperature ^{*)}	-25°C to +70°C (-13°F to 158°F)	reduce output power according Fig. 16-1
Storage temperature	-40°C to +85°C (-40°F to 185°F)	for storage and transportation
Output de-rating	2.5W/°C 4.8W/°C	45°C to 60°C (113°F to 140°F) 60°C to 70°C (140°F to 158°F)
Humidity ^{**)}	5 to 95% r.h.	IEC 60068-2-30
Vibration sinusoidal	2-17.8Hz: ±1.6mm; 17.8-500Hz: 2g ^{***)} 2 hours / axis ^{***)}	IEC 60068-2-6
Shock	30g 6ms, 20g 11ms ^{***)} 3 bumps / direction, 18 bumps in total	IEC 60068-2-27
Altitude	0 to 2000m (0 to 6 560ft) 2000 to 6000m (6 560 to 20 000ft)	without any restrictions reduce output power or ambient temperature, see Fig. 16-2. IEC 62103, EN 50178, overvoltage category II
Altitude de-rating	13.5W/1000m or 5°C/1000m	> 2000m (6500ft), see Fig. 16-2
Over-voltage category	III II	IEC 62103, EN 50178, altitudes up to 2000m altitudes from 2000m to 6000m
Degree of pollution	2	IEC 62103, EN 50178, not conductive
LABS compatibility	The unit does not release any silicone or other LABS-critical substances and is suitable for use in paint shops.	

*) Operational temperature is the same as the ambient or surrounding temperature and is defined as the air temperature 2cm below the unit.

***) Do not energize while condensation is present

***) Tested in combination with DIN-Rails according to EN 60715 with a height of 15mm and a thickness of 1.3mm and standard orientation.

Fig. 16-1 Output current vs. ambient temp.

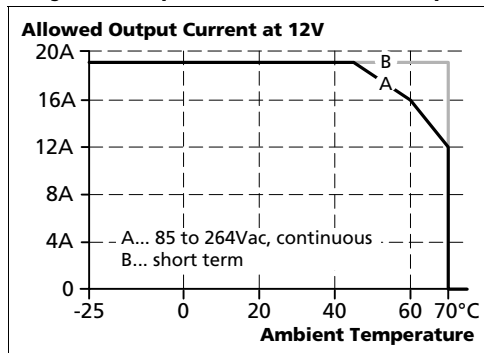
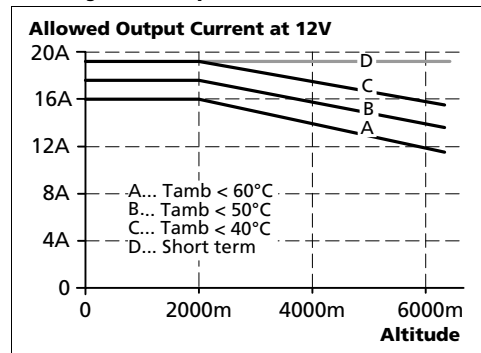

Fig. 16-2 Output current vs. altitude



17. PROTECTION FEATURES

Output protection	Electronically protected against overload, no-load and short-circuits ^{*)}	
Output over-voltage protection	typ. 18.2Vdc max. 19Vdc	In case of an internal power supply defect, a redundant circuit limits the maximum output voltage. The output shuts down and automatically attempts to restart.
Degree of protection	IP 20	EN/IEC 60529 For use in a controlled environment according to CSA 22.2 No 107.1-01.
Penetration protection	> 4mm	e.g. screws, small parts
Over-temperature protection	yes	Output shut-down with automatic restart
Input transient protection	MOV (Metal Oxide Varistor)	
Internal input fuse	included	not user replaceable

^{*)} In case of a protection event, audible noise may occur.

18. SAFETY FEATURES

Input / output separation ^{*)}	SELV PELV double or reinforced insulation	IEC/EN 60950-1 IEC/EN 60204-1, EN 50178, IEC 62103, IEC 60364-4-41
Class of protection	I	PE (Protective Earth) connection required
Isolation resistance	> 5MΩ	input to output, 500Vdc
PE resistance	< 0.1Ω	PE terminal to housing
Touch current (leakage current)	typ. 0.14mA / 0.36mA typ. 0.20mA / 0.50mA typ. 0.33mA / 0.86mA max. 0.18mA / 0.43mA max. 0.26mA / 0.61mA max. 0.44mA / 1.05mA	100Vac, 50Hz, TN-,TT-mains / IT-mains 120Vac, 60Hz, TN-,TT-mains / IT-mains 230Vac, 50Hz, TN-,TT-mains / IT-mains 110Vac, 50Hz, TN-,TT-mains / IT-mains 132Vac, 60Hz, TN-,TT-mains / IT-mains 264Vac, 50Hz, TN-,TT-mains / IT-mains

^{*)} double or reinforced insulation

19. DIELECTRIC STRENGTH

The output voltage is floating and has no ohmic connection to the ground. Type and factory tests are conducted by the manufacturer. Field tests may be conducted in the field using the appropriate test equipment which applies the voltage with a slow ramp (2s up and 2s down). Connect all input-terminals together as well as all output poles before conducting the test. When testing, set the cut-off current settings to the value in the table below.

Fig. 19-1 Dielectric strength

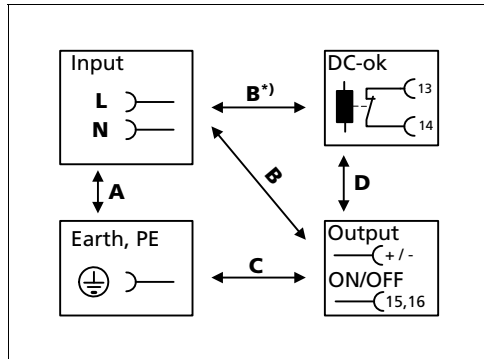









		A	B	C	D
Type test	60s	2500Vac	4000Vac	1000Vac	500Vac
Factory test	5s	2500Vac	2500Vac	500Vac	500Vac
Field test	5s	2000Vac	2000Vac	500Vac	500Vac
Cut-off current setting		> 10mA	> 10mA	> 20mA	> 1mA



To fulfil the PELV requirements according to EN60204-1 § 6.4.1, we recommend that either the + pole, the – pole or any other part of the output circuit shall be connected to the protective earth system. This helps to avoid situations in which a load starts unexpectedly or can not be switched off when unnoticed earth faults occur.

B*) When testing input to DC-OK ensure that the max. voltage between DC-OK and the output is not exceeded (column D). We recommend connecting DC-OK pins and the output pins together when performing the test.

20. APPROVALS

EC Declaration of Conformity		The CE mark indicates conformance with the - EMC directive, - Low-voltage directive (LVD) and the - ATEX directive
IEC 60950-1 2 nd Edition		CB Scheme, Information Technology Equipment
UL 508		Listed for use as Industrial Control Equipment; U.S.A. (UL 508) and Canada (C22.2 No. 107-1-01); E-File: E198865
UL 60950-1 2 nd Edition		Recognized for use as Information Technology Equipment, Level 5; U.S.A. (UL 60950-1) and Canada (C22.2 No. 60950-1); E-File: E137006 Applicable for altitudes up to 2000m.
ANSI / ISA 12.12.01-2007 Class I Div 2		Recognized for use in Hazardous Location Class I Div 2 T4 Groups A,B,C,D systems; U.S.A. (ANSI / ISA 12.12.01-2007) and Canada (C22.2 No. 213-M1987)
EN 60079-0, EN 60079-15 ATEX	 II 3G Ex nA nC II T4 Gc	Approval for use in hazardous locations Zone 2 Category 3G. Number of ATEX certificate: EPS 15 ATEX 1 101 X The power supply must be built-in in an IP54 enclosure.
IEC 60079-0, IEC 60079-15		Suitable for use in Class 1 Zone 2 Groups IIa, IIb and IIc locations. Number of IECEx certificate: IECEx EPS 15.0079X
Marine, planned		GL (Germanischer Lloyd) classified Environmental category: C, EMC2 Marine and offshore applications

21. ROHS, REACH AND OTHER FULFILLED STANDARDS

RoHS Directive		Directive 2011/65/EU of the European Parliament and the Council of June 8 th , 2011 on the restriction of the use of certain hazardous substances in electrical and electronic equipment.
REACH Directive		Directive 1907/2006/EU of the European Parliament and the Council of June 1 st , 2007 regarding the Registration, Evaluation, Authorisation and Restriction of Chemicals (REACH)

22. PHYSICAL DIMENSIONS AND WEIGHT

Width	39mm 1.54"
Height	124mm 4.88"
Depth	117mm 4.61" The DIN-rail height must be added to the unit depth to calculate the total required installation depth.
Weight	600g / 1.3lb
DIN-Rail	Use 35mm DIN-rails according to EN 60715 or EN 50022 with a height of 7.5 or 15mm.
Housing material	Body: Aluminium alloy Cover: zinc-plated steel
Installation clearances	See chapter 2

Fig. 22-1 **Front view**

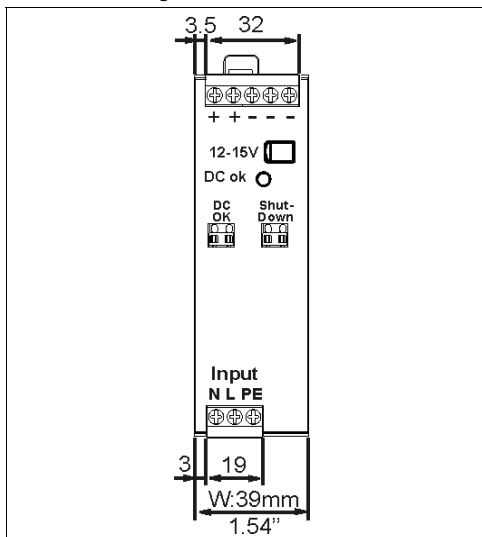
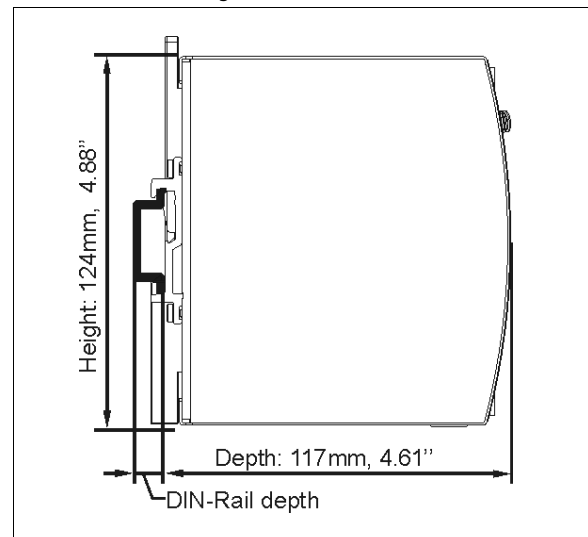

Fig. 22-2 **Side view**



23. ACCESSORIES

23.1. ZM12.SIDE - SIDE MOUNTING BRACKET

This bracket is used to mount DIMENSION units sideways with or without utilizing a DIN-Rail. The two aluminum brackets and the black plastic slider of the unit have to be detached, so that the steel brackets can be mounted.

For sideways DIN-rail mounting, the removed aluminum brackets and the black plastic slider need to be mounted on the steel bracket.

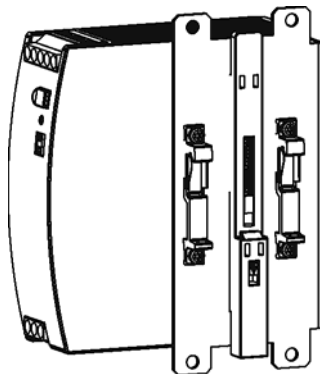

Side mounting with DIN-rail brackets

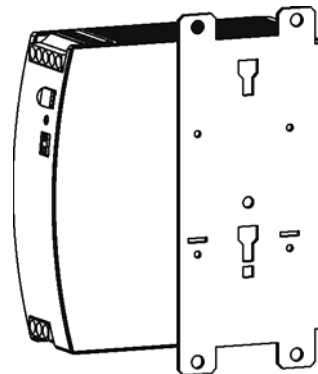

Side mounting without DIN-rail brackets

23.2. REDUNDANCY MODULE

YR40.242 – 2x 20A Inputs, 1x 40A output



The YR40.242 is equipped with two input channels, which are individually decoupled by utilizing MOSFET technology. Using MOSFETs instead of diodes reduces the heat generation and the voltage drop between input and output. The YR40.242 does not require an additional auxiliary voltage and is self-powered even in case of a short circuit across the output.

Due to the low power losses, the unit is very slender and only requires 36mm width on the DIN-rail.

Fig. 23-1 Typical 1+1 Redundant configuration for 16A with the YR40.242 MOSFET redundancy module

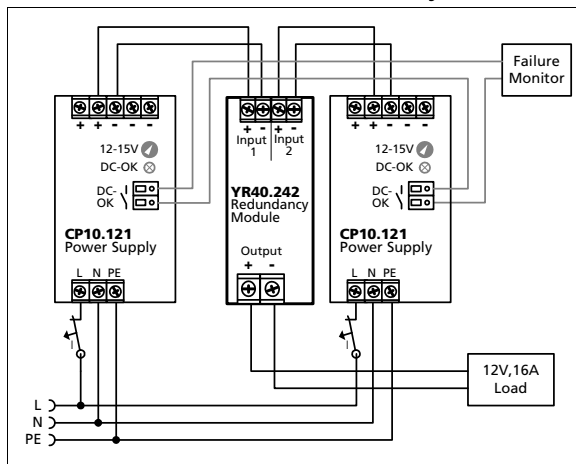

24. APPLICATION NOTES

24.1. PEAK CURRENT CAPABILITY

The unit can deliver peak currents (up to several milliseconds) which are higher than the specified short term currents. This helps to start current demanding loads. Solenoids, contactors and pneumatic modules often have a steady state coil and a pick-up coil. The inrush current demand of the pick-up coil is several times higher than the steady-state current and usually exceeds the nominal output current (including the PowerBoost). The same situation applies when starting a capacitive load.

The peak current capability also ensures the safe operation of subsequent circuit breakers of load circuits. The load branches are often individually protected with circuit breakers or fuses. In case of a short or an overload in one branch circuit, the fuse or circuit breaker need a certain amount of over-current to open in a timely manner. This avoids voltage loss in adjacent circuits.

The extra current (peak current) is supplied by the power converter and the built-in large sized output capacitors of the power supply. The capacitors get discharged during such an event, which causes a voltage dip on the output. The following two examples show typical voltage dips:

Fig. 24-1 **Peak load with 2x the nominal current for 50ms, typ.**

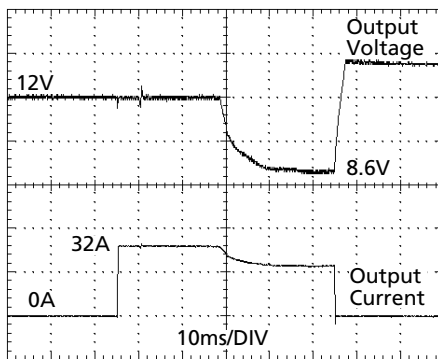

32A Peak load (resistive) for 50ms
Output voltage dips from 12V to 8.6V.

Fig. 24-2 **Peak load with 5x the nominal current for 5ms, typ.**

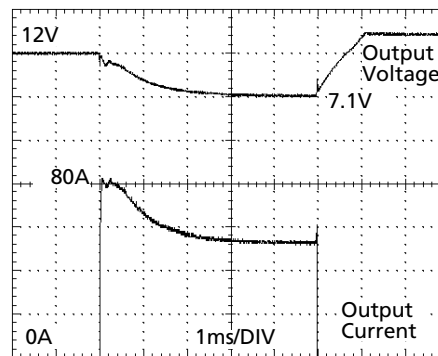

80A Peak load (resistive) for 5ms
Output voltage dips from 12V to 7.1V.

Fig. 24-3 **48A Peak load, typ.**

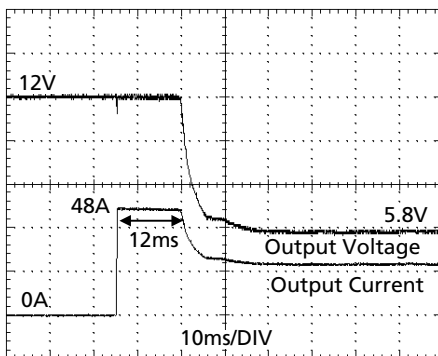

High Overload Current (typ. 48A for 12ms) enables easy fuse tripping

Please note: The DC-OK relay triggers when the voltage dips more than 10% for longer than 1ms.

Peak current voltage dips	typ.	from 12V to 8.6V	at 32A for 50ms, resistive load
	typ.	from 12V to 7.4V	at 80A for 2ms, resistive load
	typ.	from 12V to 7.1V	at 80A for 5ms, resistive load

24.2. BACK-FEEDING LOADS

Loads such as decelerating motors and inductors can feed voltage back to the power supply. This feature is also called return voltage immunity or resistance against Back- E.M.F. (Electro Magnetic Force).

This power supply is resistant and does not show malfunctioning when a load feeds back voltage to the power supply. It does not matter whether the power supply is on or off.

The maximum allowed feed-back-voltage is 25Vdc. The maximum allowed feed-back peak current is 64A. Higher currents can temporarily shut-down the output voltage. The absorbing energy can be calculated according to the built-in large sized output capacitor which is specified in chapter 6.

24.3. EXTERNAL INPUT PROTECTION

The unit is tested and approved for branch circuits up to 30A (UL) and 32A (IEC). An external protection is only required if the supplying branch has an ampacity greater than this. Check also local codes and local requirements. In some countries local regulations might apply.

If an external fuse is necessary or utilized, minimum requirements need to be considered to avoid nuisance tripping of the circuit breaker. A minimum value of 6A B- or C-Characteristic breaker should be used.

24.4. OUTPUT CIRCUIT BREAKERS

Standard miniature circuit breakers (MCB's or UL 1077 circuit breakers) are commonly used for AC-supply systems and may also be used on 12V branches.

MCB's are designed to protect wires and circuits. If the ampere value and the characteristics of the MCB are adapted to the wire size that is used, the wiring is considered as thermally safe regardless of whether the MCB opens or not.

To avoid voltage dips and under-voltage situations in adjacent 12V branches which are supplied by the same source, a fast (magnetic) tripping of the MCB is desired. A quick shutdown within 10ms is necessary corresponding roughly to the ride-through time of PLC's. This requires power supplies with high current reserves and large output capacitors. Furthermore, the impedance of the faulty branch must be sufficiently small in order for the current to actually flow. The best current reserve in the power supply does not help if Ohm's law does not permit current flow. The following table has typical test results showing which B- and C-Characteristic MCBs magnetically trip depending on the wire cross section and wire length.

Fig. 24-4 Test circuit

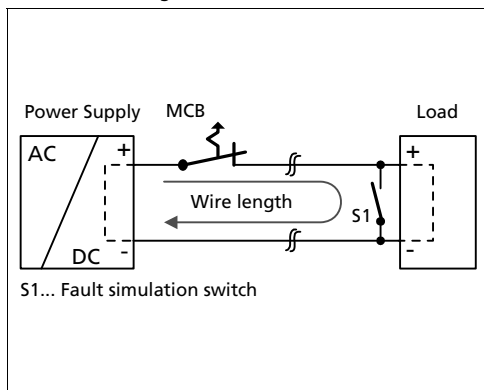

Maximal wire length^{*)} for a fast (magnetic) tripping:

	0.75mm ²	1.0mm ²	1.5mm ²	2.5mm ²
C-2A	11m	15m	22m	35m
C-3A	9m	13m	18m	23m
C-4A	5m	8m	12m	17m
C-6A	-	1m	2m	3m
B-6A	6m	11m	15m	23m
B-10A	2m	3m	3m	4m
B-13A	1m	2m	3m	4m

*) Don't forget to consider twice the distance to the load (or cable length) when calculating the total wire length (+ and - wire).

24.5. PARALLEL USE TO INCREASE OUTPUT POWER

CP10.121 power supplies can be paralleled to increase the output power. The output voltage of all power supplies shall be adjusted to the same value ($\pm 100\text{mV}$) with the same load conditions on all units, or the units can be left with the factory settings. There is no feature included which balances the load current between the power supplies. Usually the power supply with the higher adjusted output voltage draws current until it goes into current limitation. This means no harm to this power supply as long as the ambient temperature stays below 40°C .

If more than three units are connected in parallel, a fuse or circuit breaker with a rating of 25A or 32A is required on each output. Alternatively, a diode or redundancy module can also be utilized.

Energize all units at the same time to avoid the overload Hiccup^{PLUS} mode. It also might be necessary to cycle the input power (turn-off for at least five seconds), if the output was in Hiccup^{PLUS} mode due to overload or short circuits and the required output current is higher than the current of one unit.

Restrictions:

Keep an installation clearance of 15mm (left / right) between two power supplies and avoid installing the power supplies on top of each other.

Do not use power supplies in parallel in mounting orientations other than the standard mounting orientation (terminals on bottom of the unit) or in any other condition where a derating of the output current is required (e.g. altitude, ...).

Pay attention that leakage current, EMI, inrush current, harmonics will increase when using multiple power supplies.

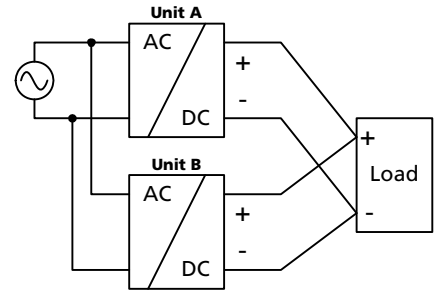

24.6. PARALLEL USE FOR REDUNDANCY

Power supplies can be paralleled for redundancy to gain higher system availability. Redundant systems require a certain amount of extra power to support the load in case one power supply unit fails. The simplest way is to put two decoupled power supplies in parallel. This is called a 1+1 redundancy. In case one power supply unit fails, the other one is automatically able to support the load current without any interruption. Redundant systems for a higher power demand are usually built in a N+1 method. E.g. five power supplies, each rated for 16A are paralleled to build a 64A redundant system. For N+1 redundancy the same restrictions apply as for increasing the output power, see also chapter 24.5.

Please note: Always use a redundancy module to decouple power supplies from each other. This prevents that the defective unit becomes a load for the other power supplies and the output voltage cannot be maintained any more. Further information and wiring configurations can be found in chapter 23.2.

Recommendations for building redundant power systems:

- Use separate input fuses for each power supply.
- Monitor the individual power supply units. Therefore, use the DC-OK relay contact of the CP10 power supply.
- It is desirable to set the output voltages of all units to the same value ($\pm 100\text{mV}$) or leave it at the factory setting.

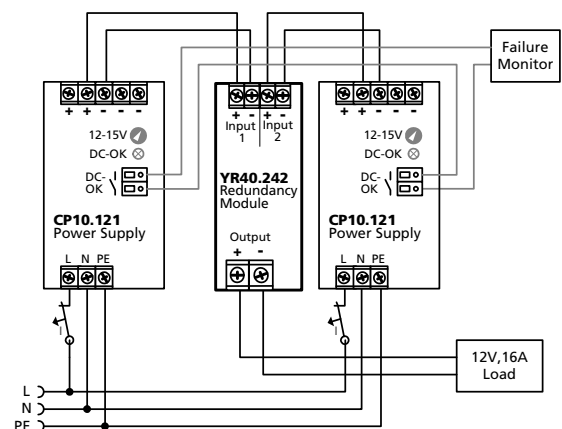

24.7. SERIES OPERATION

Power supplies of the same type can be connected in series for higher output voltages. It is possible to connect as many units in series as needed, providing the sum of the output voltage does not exceed 150Vdc. Voltages with a potential above 60Vdc are not SELV any more and can be dangerous. Such voltages must be installed with a protection against touching.

Earthing of the output is required when the sum of the output voltage is above 60Vdc.

Avoid return voltage (e.g. from a decelerating motor or battery) which is applied to the output terminals.

Restrictions:

Keep an installation clearance of 15mm (left / right) between two power supplies and avoid installing the power supplies on top of each other.

Do not use power supplies in series in mounting orientations other than the standard mounting orientation (terminals on bottom of the unit).

Pay attention that leakage current, EMI, inrush current, harmonics will increase when using multiple power supplies.

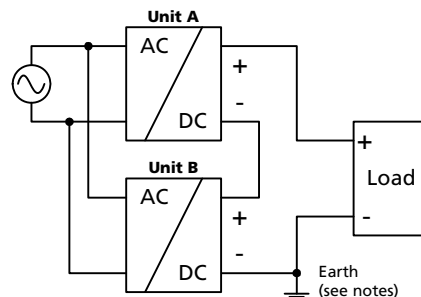

24.8. INDUCTIVE AND CAPACITIVE LOADS

The unit is designed to supply any kind of loads, including capacitive and inductive loads. If extreme large capacitors, such as EDLCs (electric double layer capacitors or "UltraCaps") with a capacitance larger than 5F are connected to the output, the unit might charge the capacitor in the Hiccup^{PLUS} mode (see chapter 6).

24.9. CHARGING OF BATTERIES

The power supply can be used to charge lead-acid or maintenance free batteries (SLA or VRLA batteries).

Instructions for charging batteries:

- a) Set output voltage (measured at no load and at the battery end of the cable) very precisely to the end-of-charge voltage.

End-of-charge voltage	13.9V	13.75V	13.6V	13.4V
Battery temperature	10°C	20°C	30°C	40°C

- b) Use a 25A circuit breaker (or blocking diode) between the power supply and the battery.
 c) Ensure that the output current of the power supply is below the allowed charging current of the battery.
 d) Ensure that the ambient temperature of the power supply stays below 40°C.
 e) The return current to the power supply (battery discharge current is typ. 2.6mA when the power supply is switched off (except in case a blocking diode is utilized).

24.10. OPERATION ON TWO PHASES

The power supply can also be used on two-phases of a three-phase-system. Such a phase-to-phase connection is allowed as long as the supplying voltage is below 240V^{+10%}.

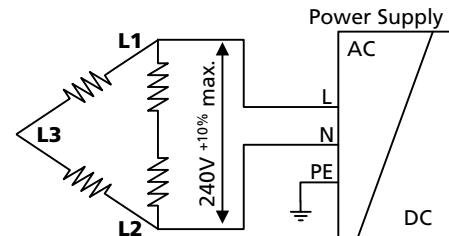

24.11. USE IN A TIGHTLY SEALED ENCLOSURE

When the power supply is installed in a tightly sealed enclosure, the temperature inside the enclosure will be higher than outside. In such situations, the inside temperature defines the ambient temperature for the power supply.

The following measurement results can be used as a reference to estimate the temperature rise inside the enclosure.

The power supply is placed in the middle of the box, no other heat producing items are inside the box

Input: 230Vac

Case A: Enclosure: Rittal Typ IP66 Box PK 9519 100, plastic, 180x180x165mm
 Load: 12V, 12.8A; (=80%) load is placed outside the box
 Temperature inside the box: 46.2°C (in the middle of the right side of the power supply with a distance of 1cm)
 Temperature outside the box: 24.4°C
 Temperature rise: 21.8K

Case B: Enclosure: Rittal Typ IP66 Box PK 9519 100, plastic, 180x180x165mm
 Load: 12V, 16A; load is placed outside the box
 Temperature inside the box: 53.4°C (in the middle of the right side of the power supply with a distance of 1cm)
 Temperature outside the box: 26.0°C
 Temperature rise: 27.4K

Case C: Enclosure: Rittal Typ IP66 Box PK 9516 100, plastic, 110x180x165mm
 Load: 12V, 12.8A; (=80%) load is placed outside the box
 Temperature inside the box: 47.4°C (in the middle of the right side of the power supply with a distance of 1cm)
 Temperature outside the box: 24.6°C
 Temperature rise: 22.8K

Case D: Enclosure: Rittal Typ IP66 Box PK 9519 100, plastic, 110x180x165mm
 Load: 12V, 16A; load is placed outside the box
 Temperature inside the box: 56.3°C (in the middle of the right side of the power supply with a distance of 1cm)
 Temperature outside the box: 25.7°C
 Temperature rise: 30.6K

24.12. MOUNTING ORIENTATIONS

Mounting orientations other than all terminals on the bottom require a reduction in continuous output power or a limitation in the maximum allowed ambient temperature. The amount of reduction influences the lifetime expectancy of the power supply. Therefore, two different derating curves for continuous operation can be found below:

Curve A1 Recommended output current.

Curve A2 Max allowed output current (results in approximately half the lifetime expectancy of A1).

Fig. 24-5
Mounting Orientation A
(Standard orientation)

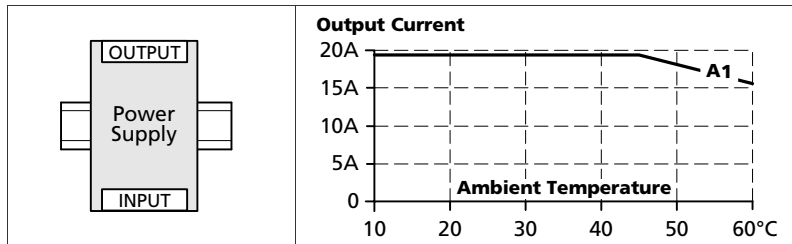

Fig. 24-6
Mounting Orientation B
(Upside down)

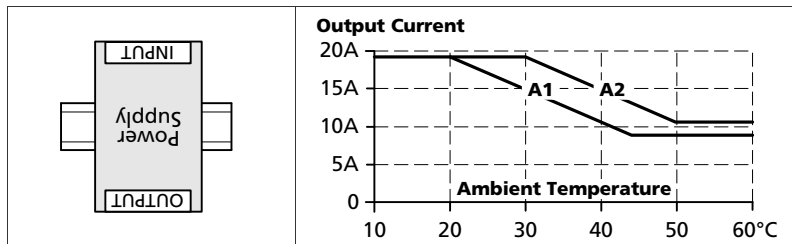

Fig. 24-7
Mounting Orientation C
(Table-top mounting)

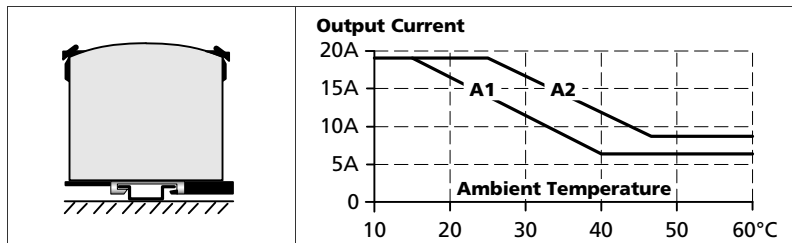

Fig. 24-8
Mounting Orientation D
(Horizontal cw)

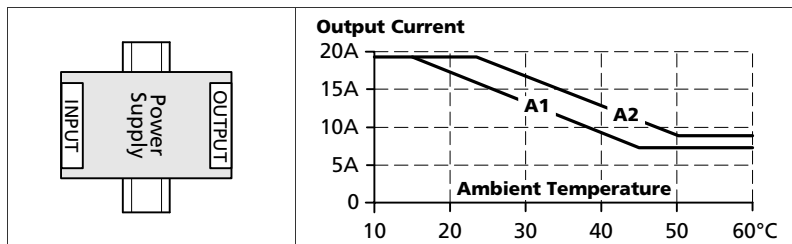
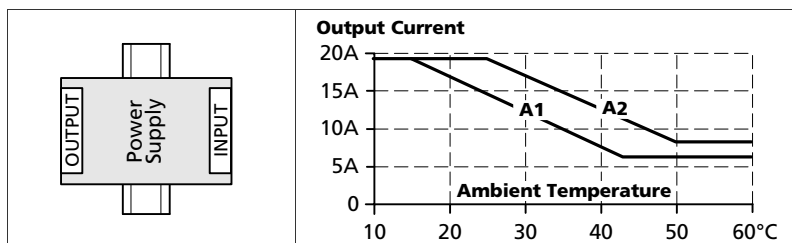

Fig. 24-9
Mounting Orientation E
(Horizontal ccw)



Feb. 2016 / Rev. 1.1 DS-CP10.121-EN
All parameters are specified at 12V, 16A, 230Vac, 50Hz, 25°C ambient and after a 5 minutes run-in time unless otherwise noted.