

PROPER USE GUIDELINES

Cumulative Trauma Disorders can result from the prolonged use of manually powered hand tools. Hand tools are intended for occasional use and low volume applications. A wide selection of powered application equipment for extended-use, production operations is available.

1. INTRODUCTION

This instruction sheet provides information on product application and installation, maintenance, and inspection procedures for:

CRIMPING HEADS USED IN...	
TOOL 69005	TOOL 69010
300454	38394
	38923

Figure 1

These instructions may be used for heads not listed in Figure 1 but accompanied by this instruction sheet. For unlisted heads, use the wire strip dimensions given in Figure 3 for an identical size head.

For information regarding general operation of the pneumatic tool, refer to Instruction Sheet 408-1410 (packaged with the tools). Read these instructions thoroughly before using the crimping head.

NOTE Dimensions on this sheet are in millimeters [with inches in brackets]. Figures and illustrations are for reference only and are not drawn to scale.

Reasons for reissue are provided in Section 8, REVISION SUMMARY.

2. DESCRIPTION

The interchangeable crimping heads have integral jaws that close in an arc-like motion. After an operator locates the terminal between the jaws and inserts the wire, the trigger is depressed and the jaws close, crimping the terminal to the wire. The jaws remain closed until the trigger is released.

Crimping heads are coated with preservative to prevent rust and corrosion. Wipe the preservative from heads, particularly from crimping surfaces.

DANGER Avoid personal injury. Keep fingers clear of crimping jaws when activating tool.

3. INSTALLATION AND REMOVAL OF CRIMPING HEAD

3.1. Installation

1. Disconnect tool from air supply.

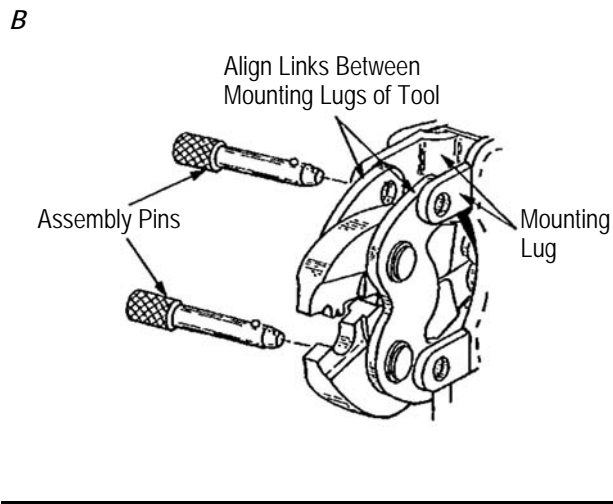
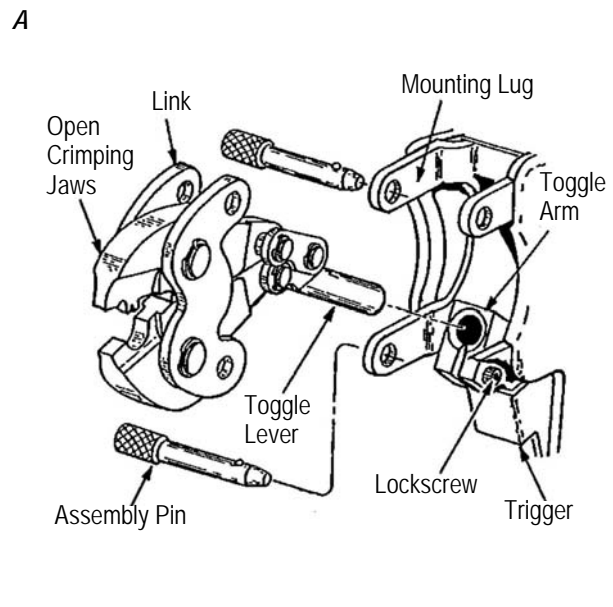

Figure 2

CAUTION Do not operate tool without having head installed and lockscrew tightened.

2. Remove assembly pins from mounting lugs as shown in Figure 2A.

3. Pull toggle arm forward and loosen lockscrew in toggle arm. Do not remove lockscrew. See Figure 2A.

TOOL	CRIMPING HEAD	WIRE RANGE	WIRE STRIP LENGTH									
			TERMINAL (Std)		TERMINAL (Lg Bbl)		FLAG TERMINAL		BUTT SPLICE		PARALLEL SPLICE	
			MIN	MAX	MIN	MAX	MIN	MAX	MIN	MAX	MIN	MAX
69005	300454	22-16	4.37 [.172]	5.16 [.203]	6.35 [.250]	7.14 [.281]	---	---	6.35 [.250]	7.14 [.281]	7.95 [.313]	8.74 [.344]
		16-14										
		16-14 HD 12-10	6.35 [.250]	7.14 [.281]	---	---	---	---	6.35 [.250]	7.14 [.281]	7.95 [.313]	8.74 [.344]
69010	38394‡	8	8.33 [.328]	8.61 [.339]	---	---	---	---	10.31 [.406]	11.09 [.437]	10.31 [.406]	11.09 [.437]
	38923‡	6	9.93 [.391]	10.72 [.422]	---	---	---	---	11.88 [.468]	12.7 [.50]	11.09 [.437]	11.88 [.468]

‡Also used for high temperature and heat resistant STRATO-THERM terminals and splices.

Figure 3

- Open jaws and insert toggle lever of crimping head all the way into hole in toggle arm.
- Tighten lock screw just enough to hold toggle lever in toggle arm.
- Move head so that links align between mounting lugs of tool. See Figure 2B.
- After head is aligned, lower it to provide access to lock screw on toggle arm. Tighten lock screw.
- Move head back between mounting lugs and insert assembly pins.
- Connect tool to air supply (550-690kPa [85-100psi]). Tool is now ready to be used.

3.2. Removal

- Disconnect tool from air supply.
- Remove assembly pins and lower head until lock screw in toggle arm is visible.
- Loosen lock screw and pull head out of toggle arm.

4. WIRE STRIPPING AND CRIMPING PROCEDURES



Avoid personal injury. When operating air tool, exercise caution while holding terminals, splices or wire near crimping area.

- Strip wire to dimension listed in Figure 3. Do not nick or cut conductor strands.
- Insert stripped wire into wire barrel of terminal or splice, as shown in Figure 4, 5, 6, or 7.
- Place terminal or splice in crimping jaws as shown in Figure 4, 5, 6, or 7. For best results, when brazed seam on splice is visible, position seam toward upper jaw.

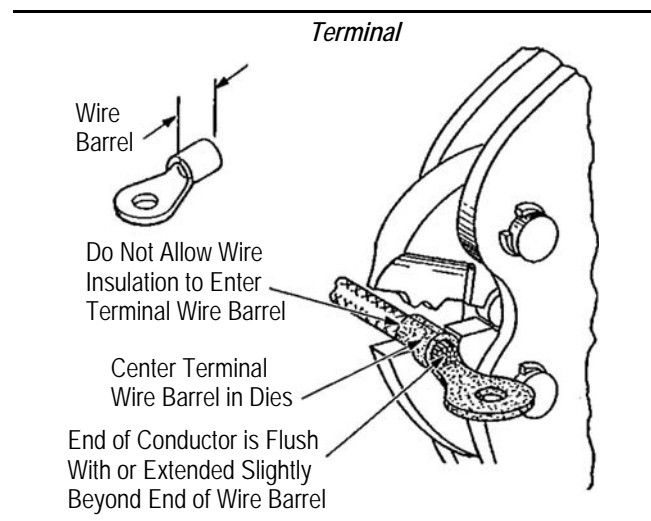

Figure 4

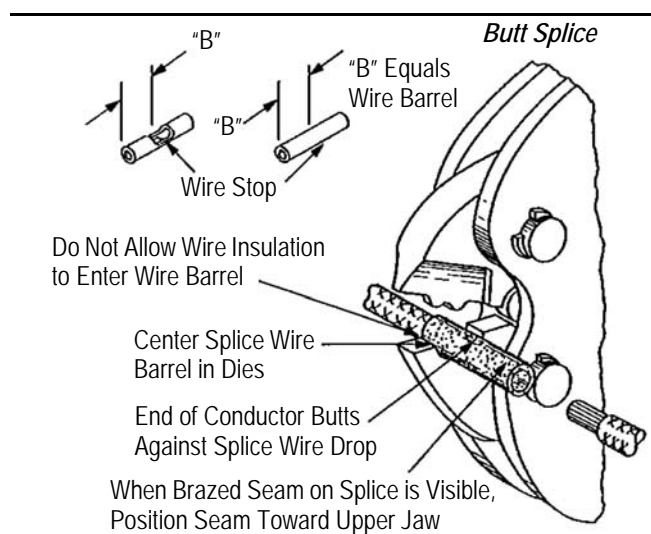

Figure 5

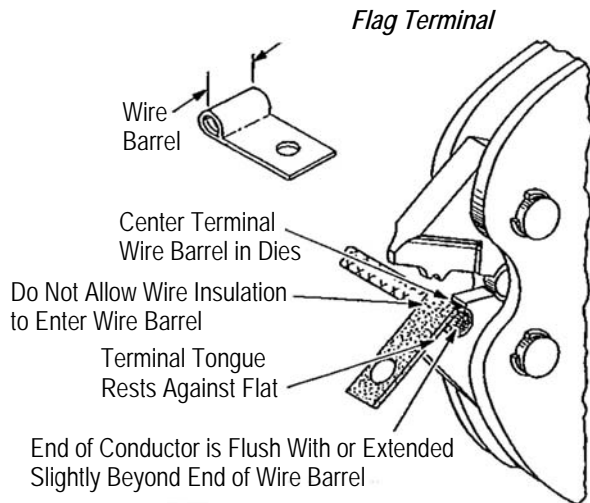
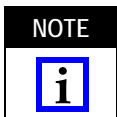

Figure 6



When using heads that have three (3) die closures, make certain terminal or splice is placed in correct closure for the wire size being used. When crimping flag terminals, make certain terminal tongue is held against flat of lower jaw until crimp is started. See Figure 6.

4. Hold terminal or splice in place and activate tool to complete the crimp.
5. To crimp other half of butt splice, remove it and reposition uncrimped half in crimping jaws and follow same procedure used to crimp first half of splice. If splice cannot be turned, turn tool around.
6. Refer to Section 5 and Figure 8 for terminal or splice crimp inspection procedure.

5. CRIMP INSPECTION

Inspect crimped terminals and splices by checking the features described in Figure 8. Use only the terminations that meet conditions shown in the "ACCEPT" column. "REJECT" terminations can be avoided through careful use of instructions in Section 4, and by performing regular tool maintenance as instructed in Section 6.

6. MAINTENANCE/INSPECTION PROCEDURE

TE Connectivity recommends that a maintenance/inspection program be performed periodically to ensure dependable and uniform terminations. Heads should be inspected at least once a month.

Parallel Splices

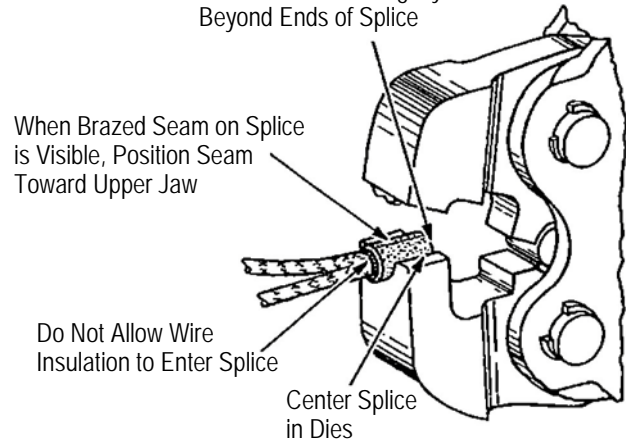
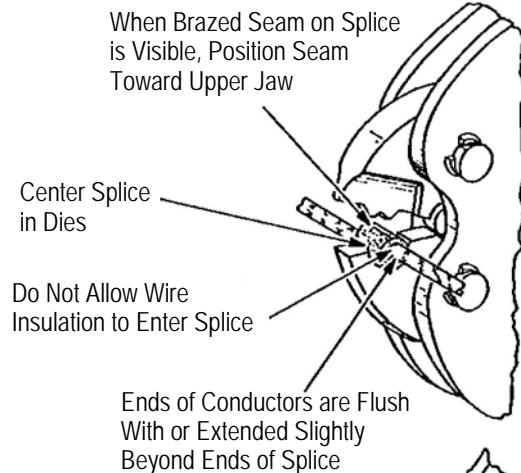

Figure 7

Frequency of inspection may be adjusted to suit your requirements through experience. Frequency of inspection depends on:

1. The care, amount of use, and handling of the head.
2. The type and size of the products crimped.
3. The degree of operator skill.
4. The presence of abnormal amounts of dust and dirt.
5. Your own established standards.

Each crimping head is thoroughly inspected before packaging. New crimping heads should be inspected in accordance with Section 6 immediately upon its arrival at your facility.

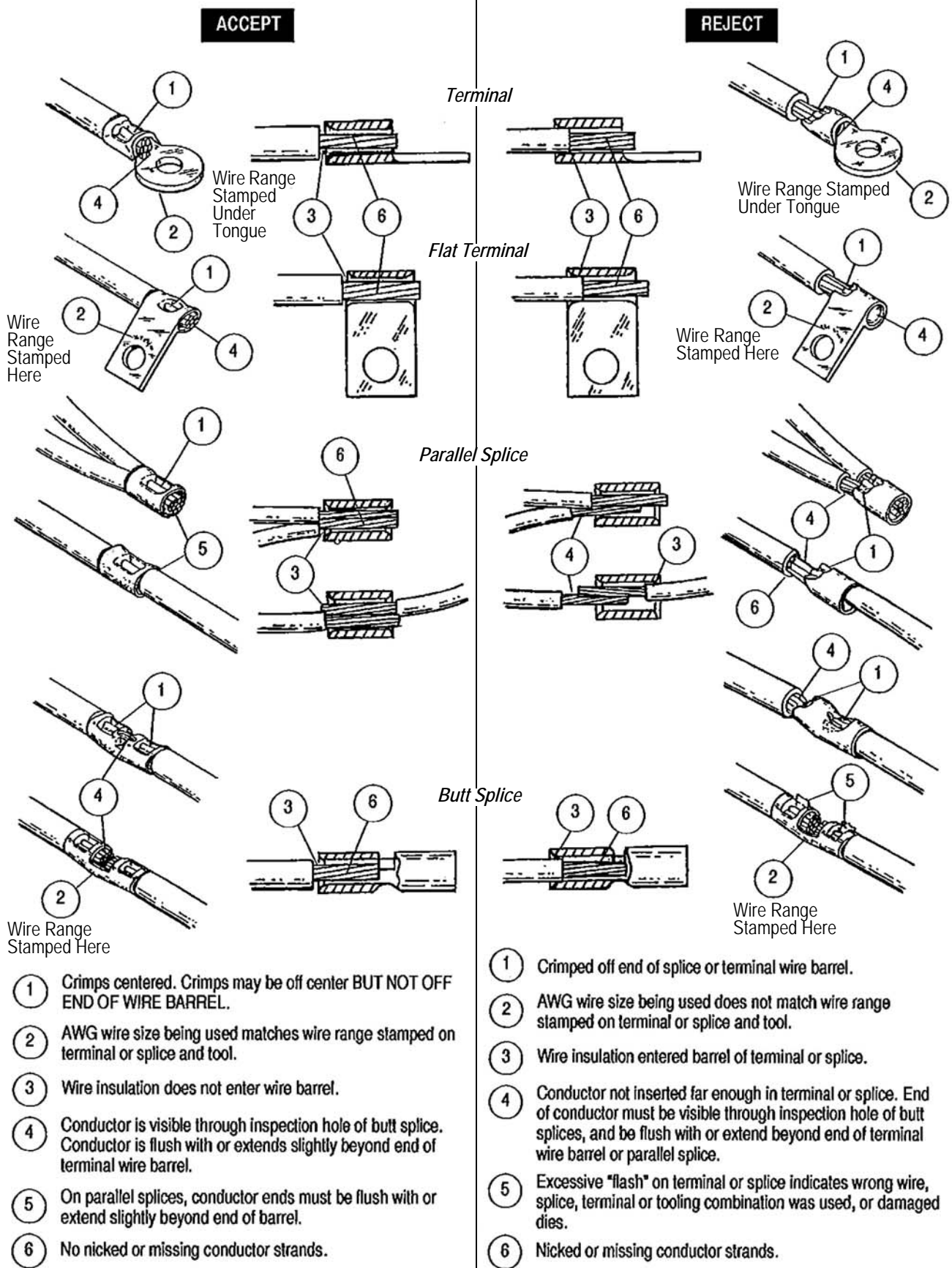

Figure 8

6.1. Cleaning

The crimping head should be immersed in degreasing compound to remove accumulated dirt, grease, and foreign matter. Remove remaining degreasing compound with a clean, lint-free cloth. When degreasing compounds are not available, head may be wiped clean with a lint-free cloth. Relubricate head as instructed in Paragraph 6.3 before placing it back in service.

6.2. Visual Inspection

1. Inspect the crimping head for missing pins or retaining rings. If parts are missing or defective, refer to Figure 12 for customer-replaceable parts.
2. Inspect the die closure surfaces for flattened, broken, or pitted conditions. Although dies may gage within permissible limits, worn or damaged die closure surfaces are objectionable and can affect the quality of the crimp. Examples of possible damaged die closure surfaces are shown in Figure 9.

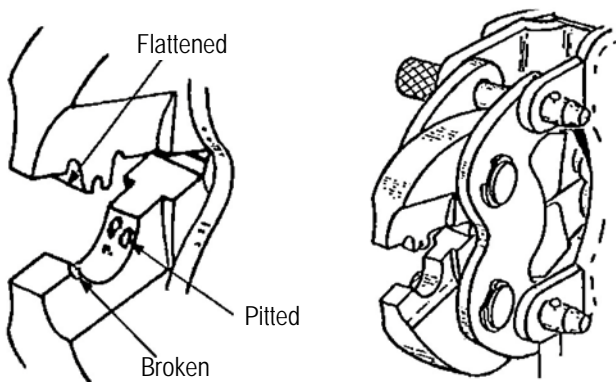

Figure 9

6.3. Lubrication

Lubricate all pins, pivot points, and bearing surfaces with any good SAE 20 motor oil as follows:

- Heads used in daily production - Lubricate daily
- Heads used daily (occasional) - Lubricate weekly
- Heads used weekly - Lubricate monthly

Wipe excess oil from head, particularly from die closure area. Oil transferred from the die closure onto certain terminations may affect the electrical characteristics of an application.

6.4. Gaging the Crimping Chambers

This inspection requires the use of a plug gage conforming to the dimensions provided in Figure 10. TE does not manufacture or market these gages. To gage the crimping chamber, proceed as follows:

1. DISCONNECT AIR SUPPLY and remove head from tool.
2. Remove traces of oil or dirt from jaw bottoming surfaces, die closure surfaces, and plug gage elements.
3. With crimping jaws bottomed, check the wire barrel crimp die closure using the proper plug gage. Hold gage in straight alignment with the die closure and carefully try to insert, without forcing, the GO element. See Figure 11. The GO element must pass completely through the die closure.
4. Try to insert the NO-GO element. The NO-GO element may enter partially, but must not pass completely through the die closure.

If crimping chambers conform to gage inspection, the tool is considered dimensionally correct, and should be lubricated with a THIN coat of any good SAE 20 motor oil. If not, refer to Section 7, REPLACEMENT AND REPAIR for customer repair service.

7. REPLACEMENT AND REPAIR

Customer-replaceable parts are listed in Figure 12. A complete inventory can be stocked and controlled to prevent lost time when replacement of parts is necessary. Order replacement parts through your TE Representative, or call 1-800-526-5142, or send a facsimile of your purchase, or write to:

CUSTOMER SERVICE (038-035)
 TYCO ELECTRONICS CORPORATION
 PO BOX 3608
 HARRISBURG PA 17105-3608

Tools may also be returned to TE for evaluation and repair. For tool repair service, contact a TE Representative at 1-800-526-5136.

8. REVISION SUMMARY

Revisions to this document include:

- Updated document to corporate requirements
- Reactivation of document
- Deleted obsolete part numbers and related information throughout document

Suggested Plug Gage Design

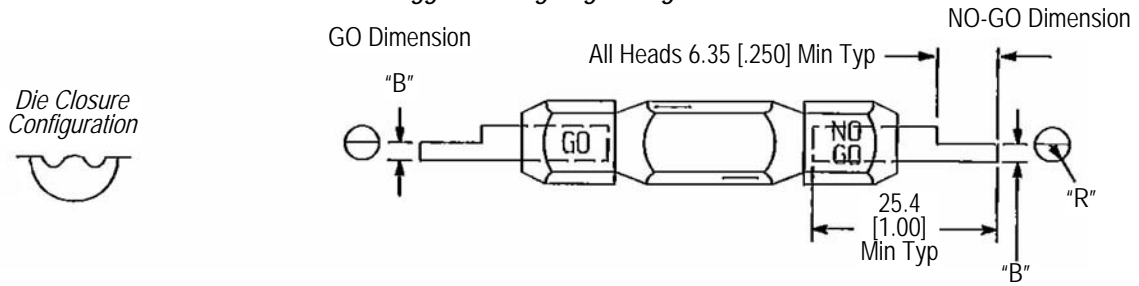

HEAD NUMBER	WIRE SIZE	GAGE ELEMENT DIMENSION "B"		RADIUS "R"
		GO	NO-GO	
38394	8	2.540-2.547 [.1000-.1003]	2.690-2.692 [.1059-.1060]	3.58 [.141]
38923	6	3.149-3.157 [.1240-.1243]	3.299-3.302 [.1299-.1300]	3.96 [.156]
300454	22-16	1.168-1.176 [.0460-.0463]	1.318-1.320 [.0519-.0520]	1.57 [.062]
	16-14	1.371-1.379 [.0540-.0543]	1.521-1.524 [.0599-.0600]	1.57 [.062]
	16-14 HD 12-10	1.930-1.938 [.0760-.0763]	2.080-2.082 [.0819-.0820]	2.36 [.093]

Figure 10

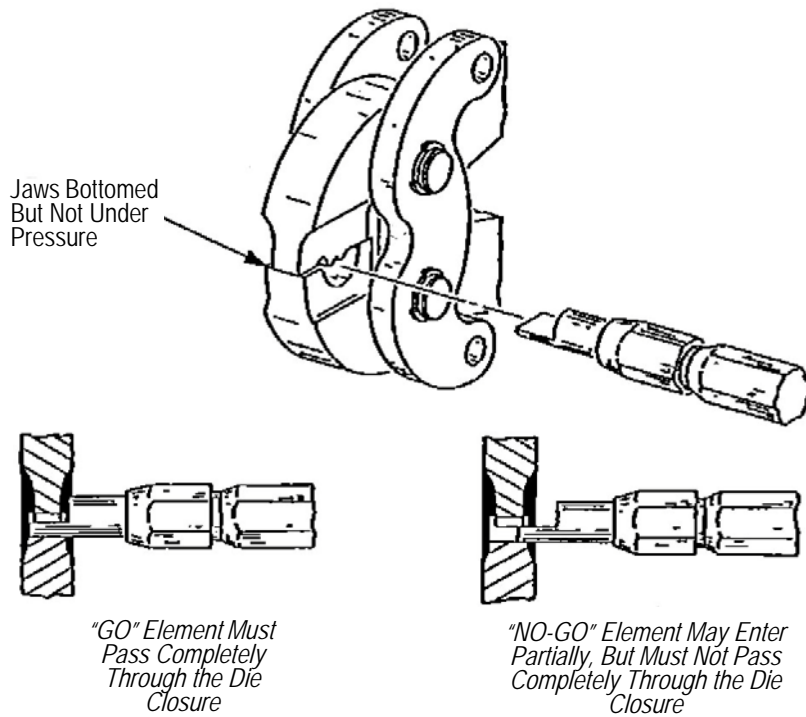
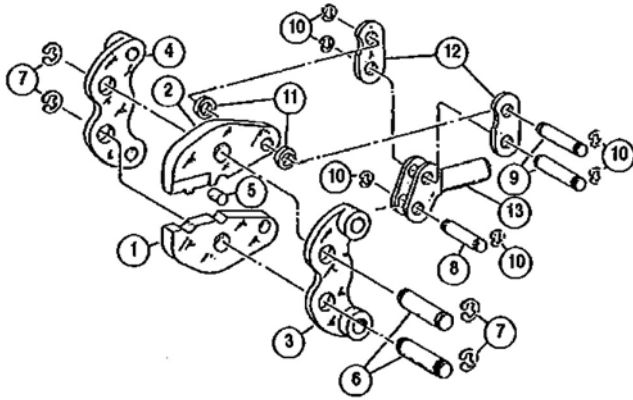

Figure 11

Detail "A"



38923
38394



Detail "B"



300454

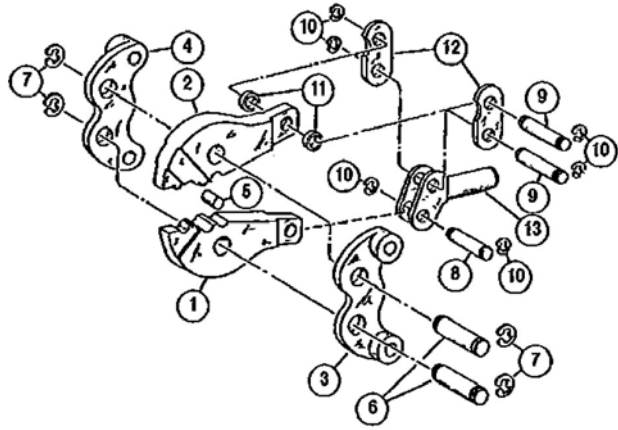

ITEM	DESCRIPTION	QTY PER HEAD	HEAD NUMBERS AND COMPONENT PART NUMBERS		
			38923 (Detail "A")	38394 (Detail "A")	300454 (Detail "B")
1	Crimping Jaw	1	49632	49493	313525-1
2	Crimping Jaw	1	49633	49492	313526-1
3	Link	1	306322-7	306322-1	5-306321-2
4	Link	1	306322-4	306322-4	3-306321-3
5	Pin, Pivot	1	38385	38385	39141
6	Pin	2	38384	38384	38782
7	Ring, Retaining	4	300102	300102	21045-6
8	Pin	1	300448	300448	38783
9	Pin	2	2-23620-9	2-23620-9	38781
10	Ring, Retaining	6	21045-6	21045-6	21045-3
11	Spacer	2	38716	38716	38779
12	Ling, Toggle	2	38380	38380	38039
13	Lever, Toggle	1	38379	38379	38043

Figure 12