

SPECIFICATION

- Part No. : **MAT.500.B**
- Product Name : MAT.500.B 5in1 Multi-Band Antenna Board
LTE MIMO + GPS/GLONASS +Wi-Fi MIMO
- Features : 2* LTE MIMO 698-960MHz/1710-2170MHz/
2490-2690MHz
2* Wi-Fi MIMO 2.4GHz/5GHz
1* GPS-GLONASS Antenna
Worldwide 4G Bands including 3G and 2G
Dims: 157.32mm*103.19mm*30mm
IPEX connectors, 1.37mm cables
RoHS Compliant



1. Introduction

The MAT.500.B embedded antenna board combines LTE MIMO antennas, Wi-Fi MIMO antennas, plus GPS/GLONASS antenna. It can be used as a reference design or actual embedded antenna for telematics applications such as fleet management, asset tracking, and security/surveillance.

The board comes with five IPEX connectors and 1.37mm coax cables for LTE, Wi-Fi, and GPS/GLONASS antennas.

Typical applications:

- Automotive and Heavy Equipment Vehicle Tracking and Telematics
- Remote Asset and Pipeline Monitoring
- HD Video over LTE
- First Responder and Emergency Services
- Global Data Communications/IoT

LTE 4G applications demand high speed data uplink and downlink. High efficiency and high gain MIMO antennas are necessary to achieve the required signal to noise ratio and throughput required to solve these challenges. Taoglas also takes care to have high isolation between the two MIMO antennas to prevent self-interference. Low loss cables are used to keep efficiency high over long cable lengths.

The GPS-GLONASS passive antenna receives efficiently on all two bands, leading to higher location accuracy and stability of tracking in urban environments.

The unique omnidirectional Wi-Fi antennas provide high efficiency and high isolation between antenna elements in a heavy-duty low profile compact structure, delivering powerful MIMO antenna technology for Wi-Fi 802.11n and emerging 802.11ac.

Cable length and connector types are customizable. Contact your regional Taoglas sales office for support.

2. Specification

GPS-GLONASS	
Center Frequency	GPS:1575.42±1.023 MHz GLONASS:1602±5 MHz
Passive Antenna Efficiency	GPS: 75% GLONASS: 68%
Average gain	GPS: -1.2dBi GLONASS: -1.6dBi
Peak gain	GPS: 5.47dBi GLONASS: 4.9dBi
VSWR	2:1 Max
Impedance	50Ω
Axial Ratio	GPS: < 5.1 GLONASS: < 6.3
Polarization	RHCP
Cable	ψ1.37 Micro Coax. 68mm standard, fully customizable
Connector	IPEX standard, fully customizable

4G/3G/2G LTE Antenna							
Frequency (MHz)	LTE700	GSM850	GSM900	DCS	PCS	UMTS1	LTE2600
	698~803	824~894	880~960	1710~1880	1850~1990	1920~2170	2490~2690
Efficiency (%)							
MIMO_1	44.65	50.40	28.06	68.20	67.23	56.83	33.30
MIMO_2	40.43	35.92	25.54	66.06	60.22	56.20	29.30
Average Gain(dBi)							
MIMO_1	-3.58	-3.04	-5.70	-1.67	-1.74	-2.55	-4.78
MIMO_2	-4.00	-4.60	-5.93	-1.83	-2.21	-2.51	-5.34
Peak Gain(dBi)							
MIMO_1	0.28	1.70	1.70	6.79	7.06	6.81	1.35
MIMO_2	0.55	1.07	-1.42	5.23	5.23	4.64	1.38
Envelope Correlation Coefficient (ECC)					< 0.33		
Impedance					50Ω		
Polarization					Linear		
VSWR					< 4		
Cable					ψ1.37 78mm/MIMO_1, 133mm/MIMO_2 standard, fully customizable		
Connector					I-PEX standard, fully customizable		

2.4GHz/5GHz Wi-Fi Antenna		
Frequency (MHz)	2400~2500	4900~5850
Efficiency (%)		
MIMO_1	50.51	61.87
MIMO_2	65.72	60.18
Average Gain(dBi)		
MIMO_1	-2.97	-2.10
MIMO_2	-1.84	-2.22
Peak Gain(dBi)		
MIMO_1	5.14	4.77
MIMO_2	5.82	4.96
Impedance	50Ω	
Polarization	Linear	
VSWR	< 2.2	
Cable	ϕ1.37 Micro Coax. 68mm for MIMO_1, 118mm for MIMO_2 standard, fully customizable	
Connector	I-PEX standard, fully customizable	

MECHANICAL	
Antenna Dimensions	157.32mm*103.19mm*30mm
Weight	66g
ENVIRONMENTAL	
Operation Temperature	-40°C to 85°C
Storage Temperature	-40°C to 90°C
Humidity	Non-condensing 65°C 95% RH



3. Antenna Characteristics

3.1 GPS-GLONASS Antenna

3.1.1 Test Setup



3.1.2 GPS-GLONASS Return Loss

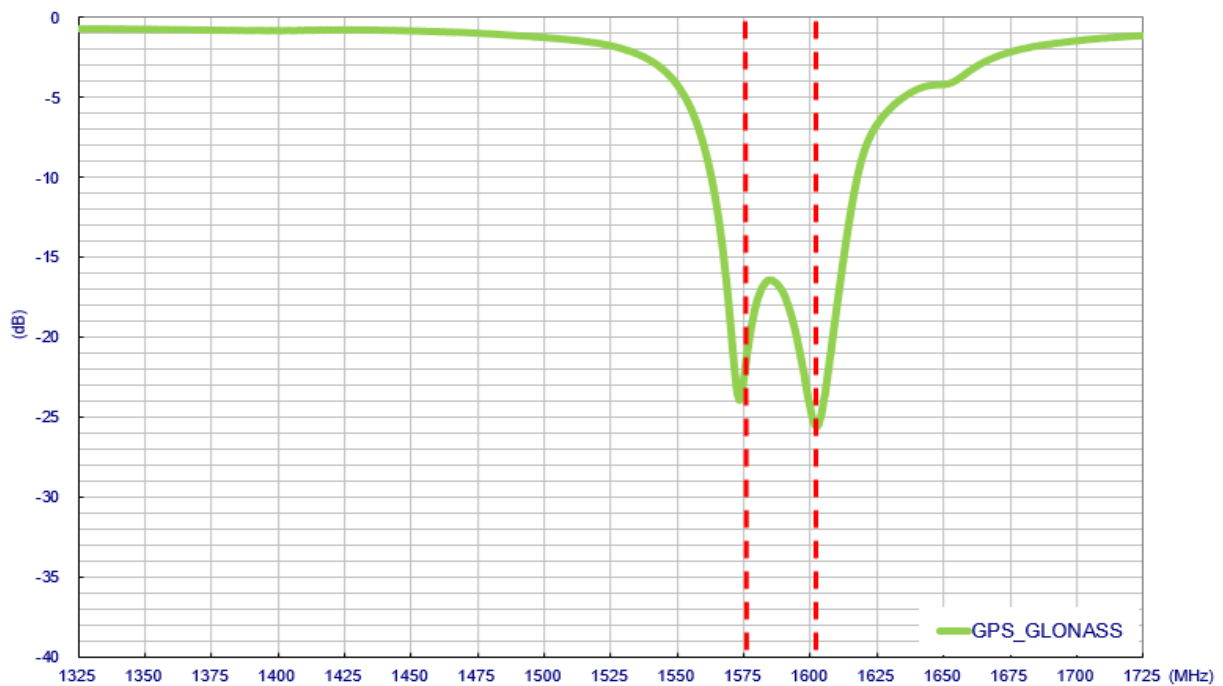

3.1.3 GPS-GLONASS Smith Chart

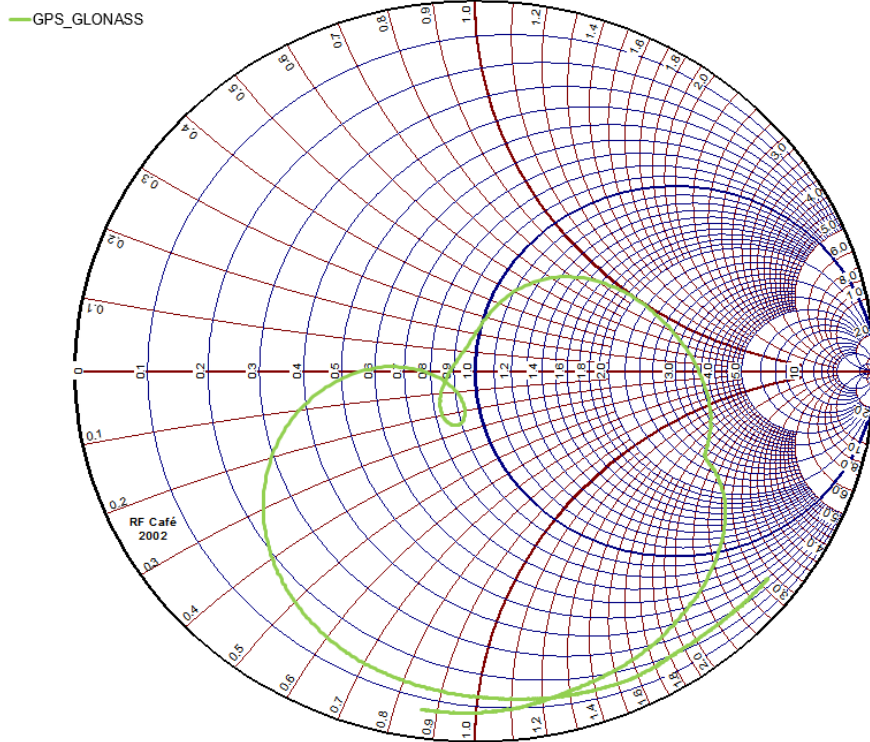

3.1.4 GPS-GLONASS VSWR

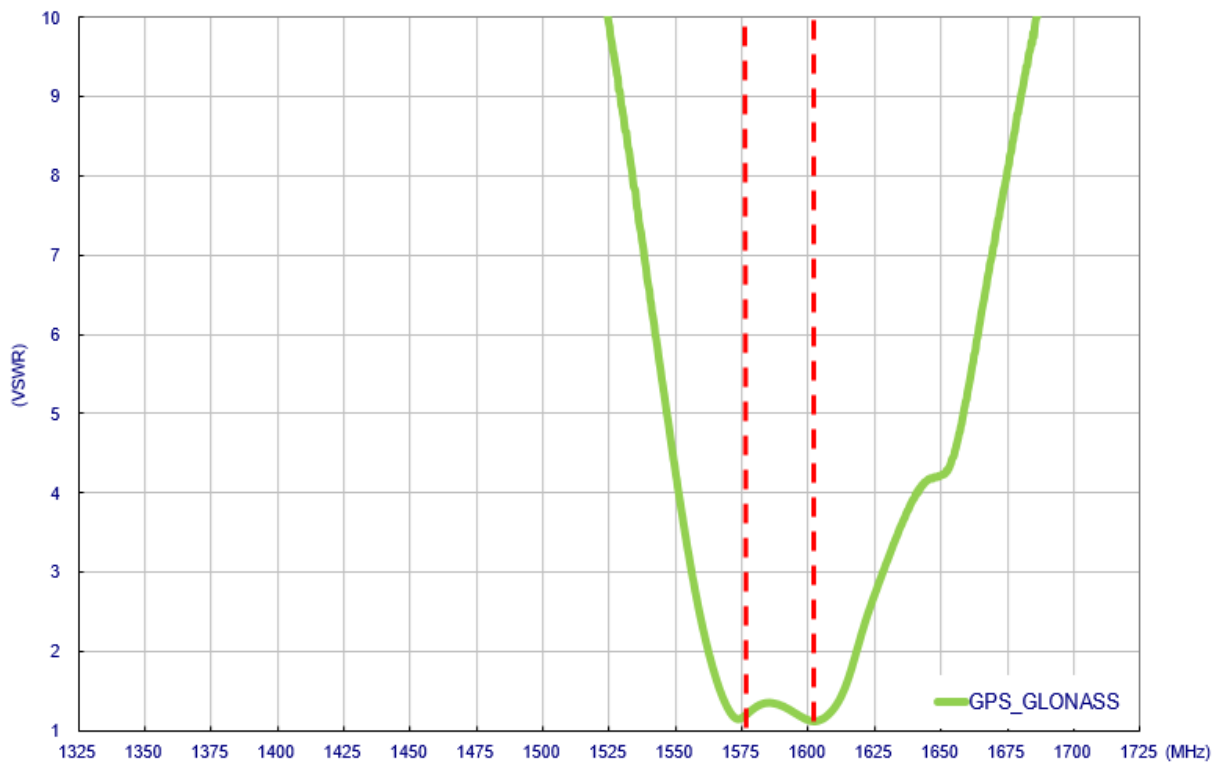

3.1.5 GPS-GLONASS Efficiency

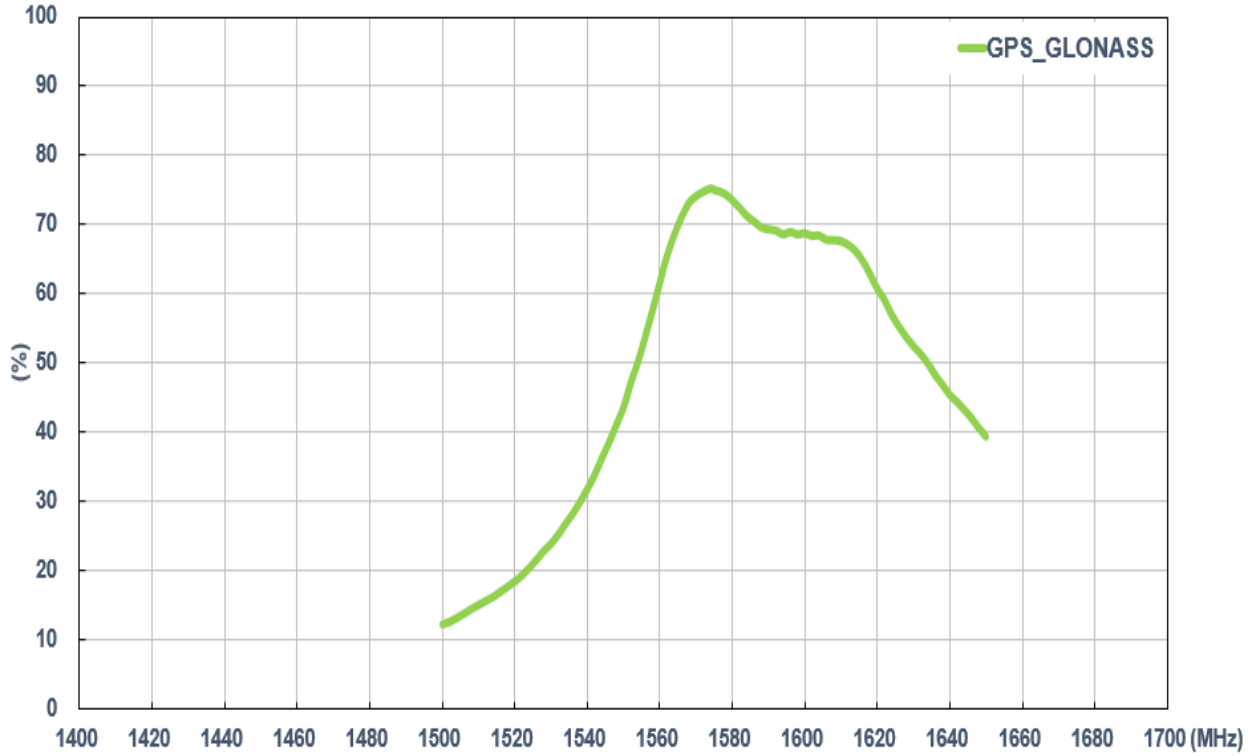

3.1.6 GPS-GLONASS Average Gain

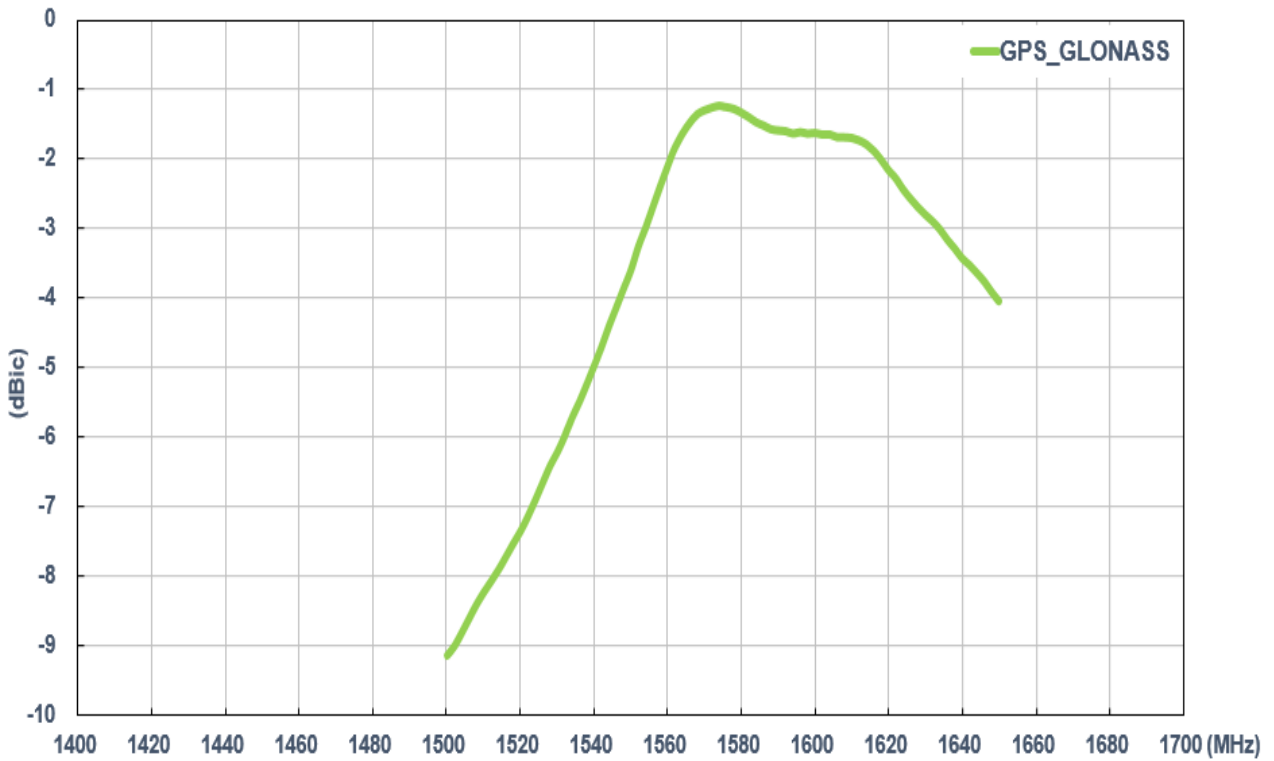

3.1.7 GPS-GLONASS Peak Gain

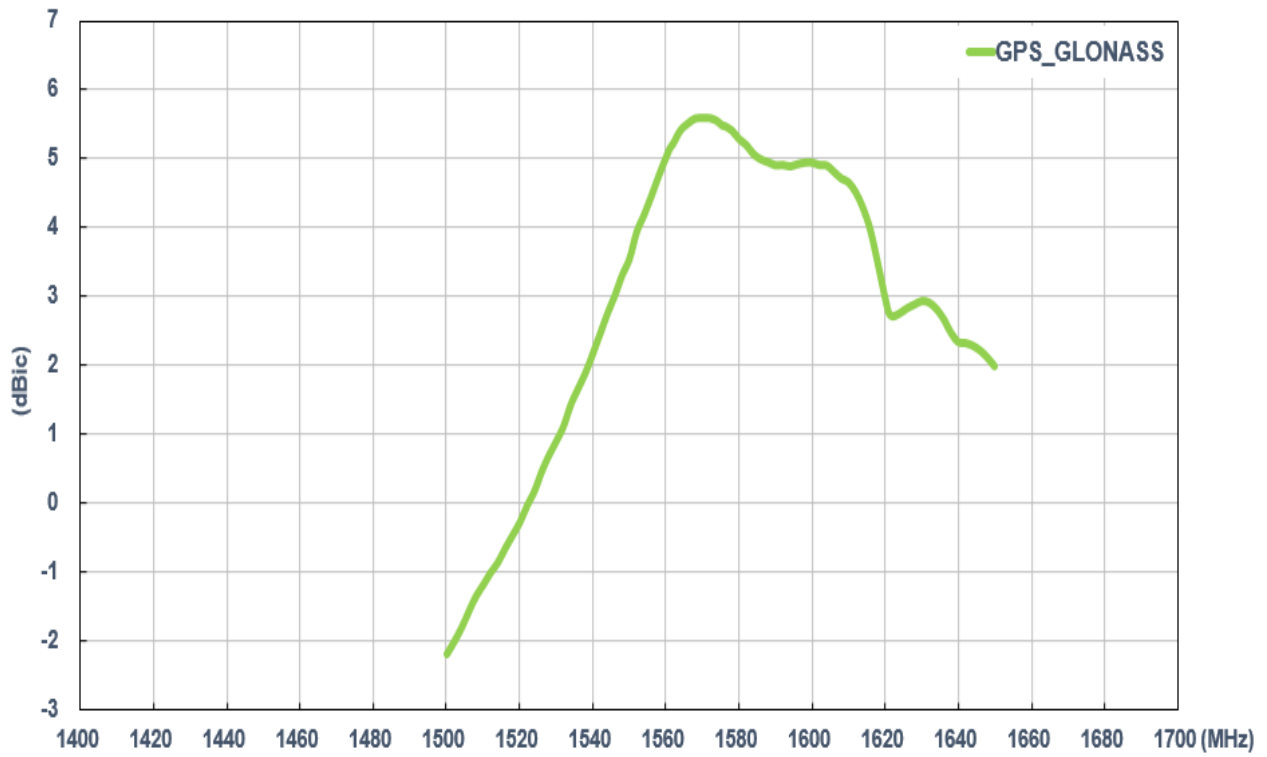

3.1.8 Test Setup for Antenna Radiation Pattern

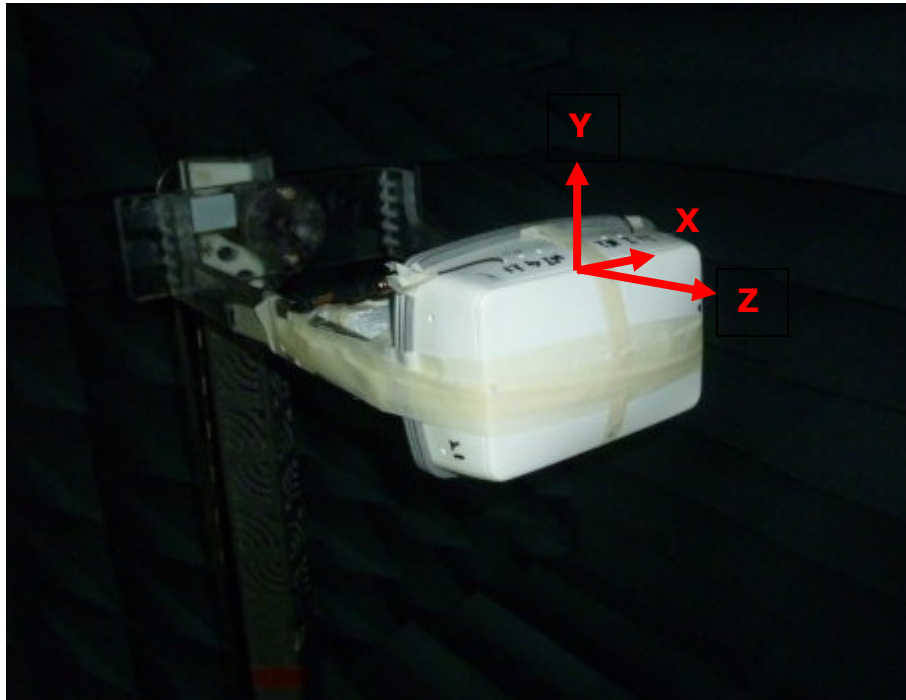

In ZRM 500 Housing

3.1.9 GPS-GLONASS 2D Radiation Pattern

2D Radiation Pattern @ 1575.42MHz

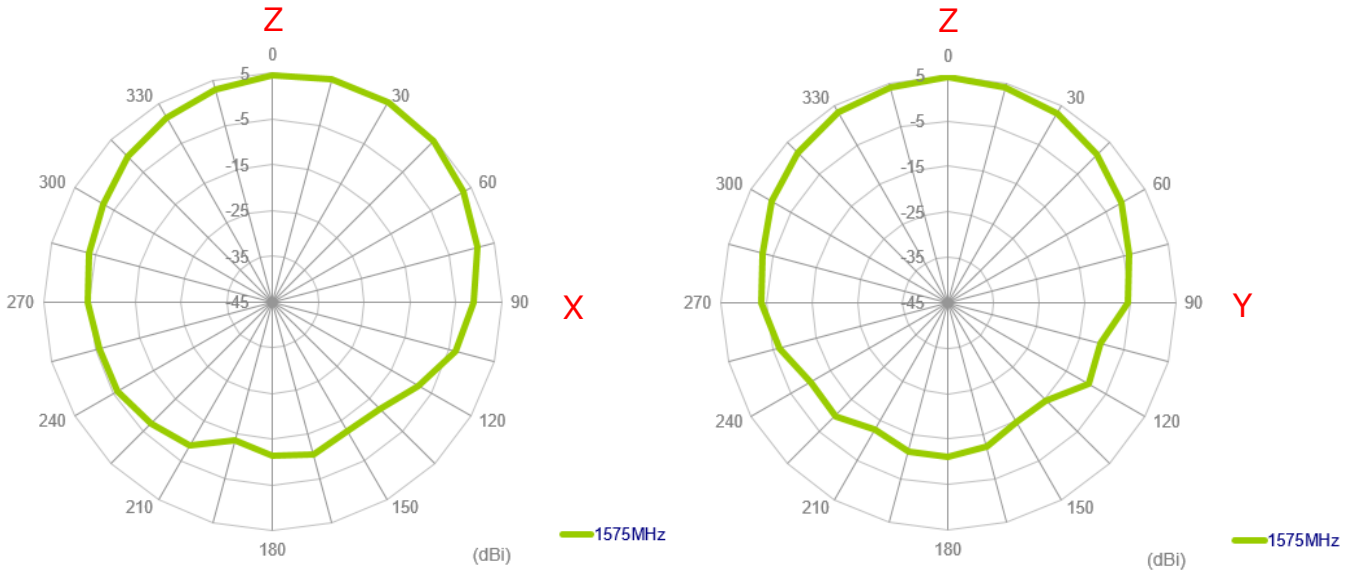

XZ Plane ($\phi=0^\circ$, θ) YZ Plane ($\phi=90^\circ$, $\theta=0\sim 360^\circ$)

3.1.10 GPS-GLONASS 3D Radiation Pattern

3D Radiation pattern @ 1575.42MHz

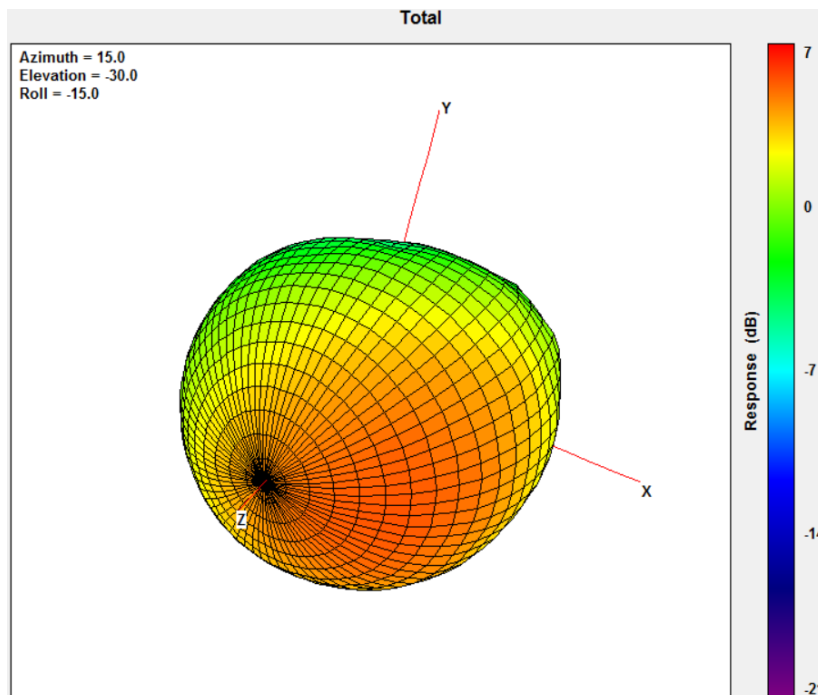

3.1.11 GPS-GLONASS 2D Radiation Pattern

2D Radiation pattern @ 1602MHz

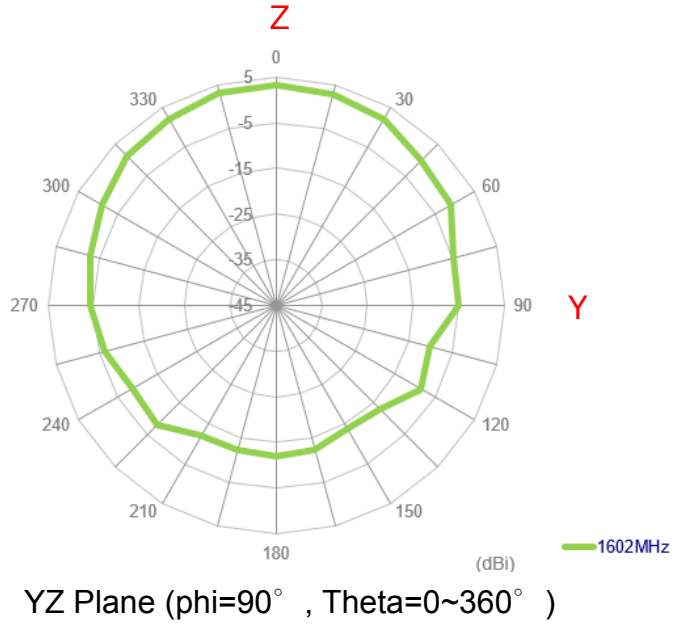
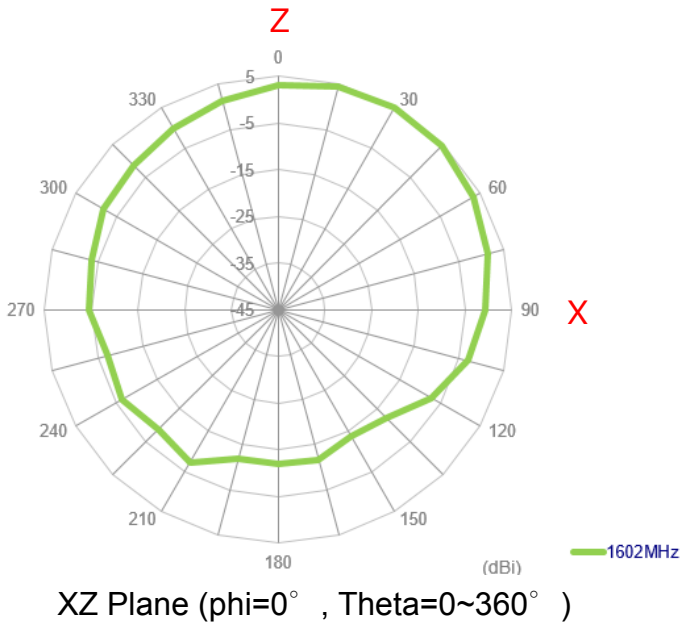

3.1.12 GPS-GLONASS 3D Radiation Pattern

3D Radiation pattern @ 1602MHz

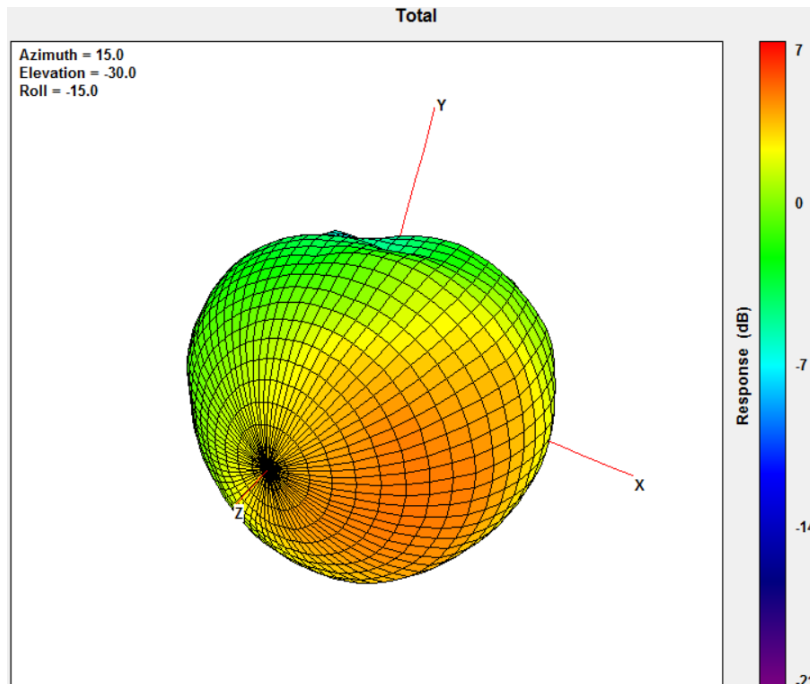

3.1.13 Axial Ratio Pattern

Frequency: 1575.42MHz

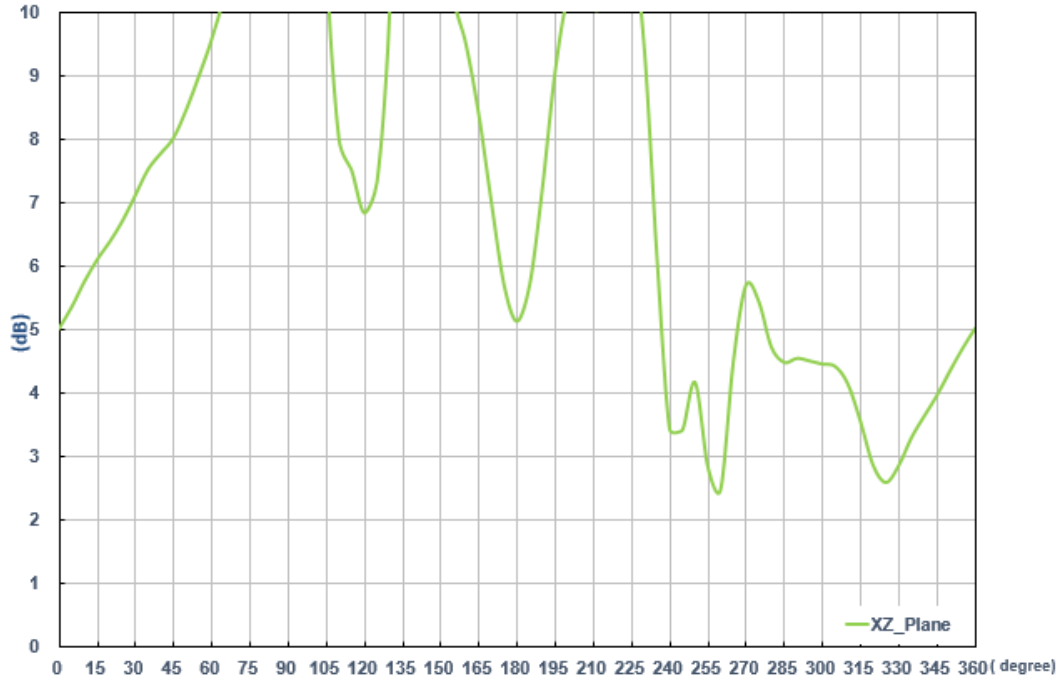

XZ Plane (phi=0° , Theta= -180~180°), 0 degree face Zenith

Frequency: 1602MHz

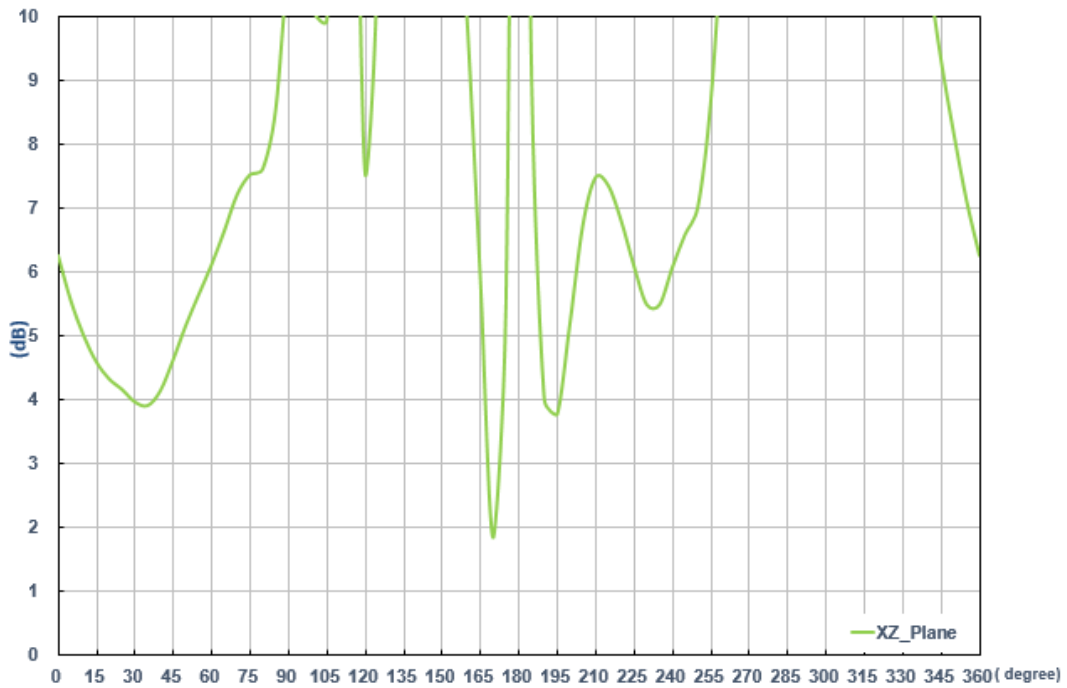

XZ Plane (phi=0° , Theta= -180~180°), 0 degree face Zenith

3.2 LTE_MIMO/Wi-Fi_MIMO Antenna

3.3.1 Test Setup



3.3.2 LTE MIMO Antenna S-parameters

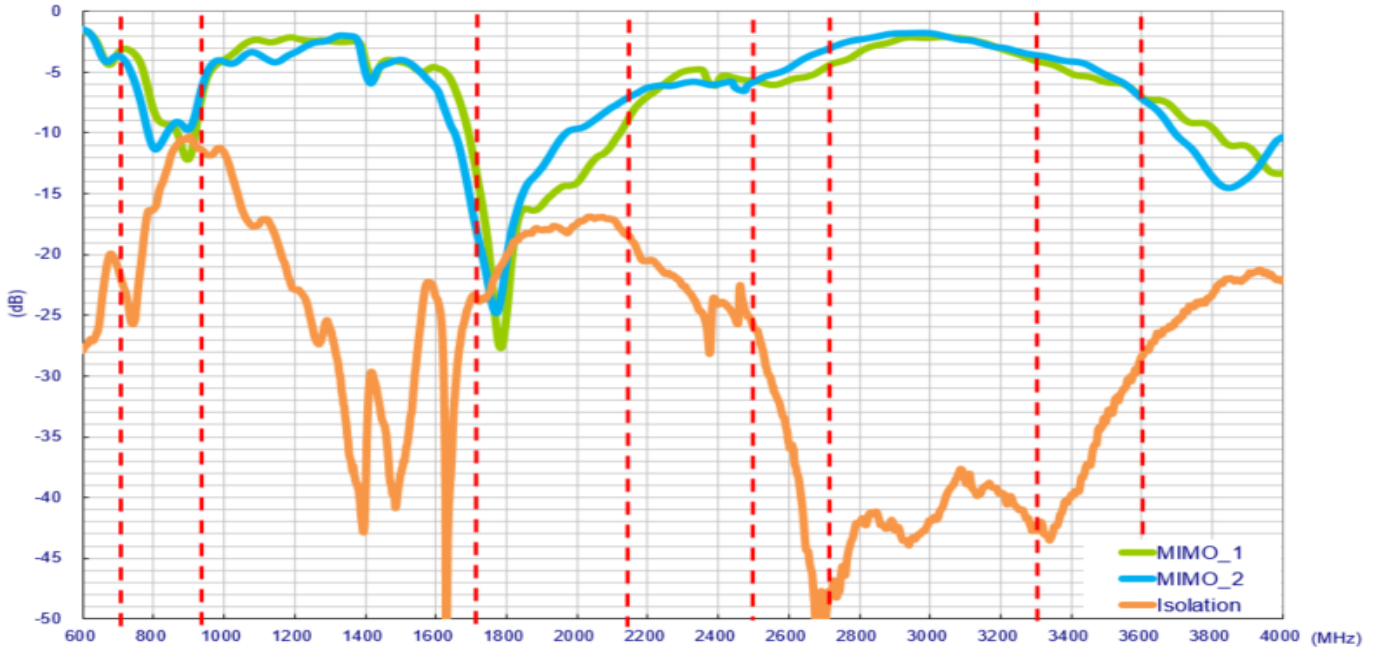

3.3.3 Envelope Correlation Coefficient (LTE)

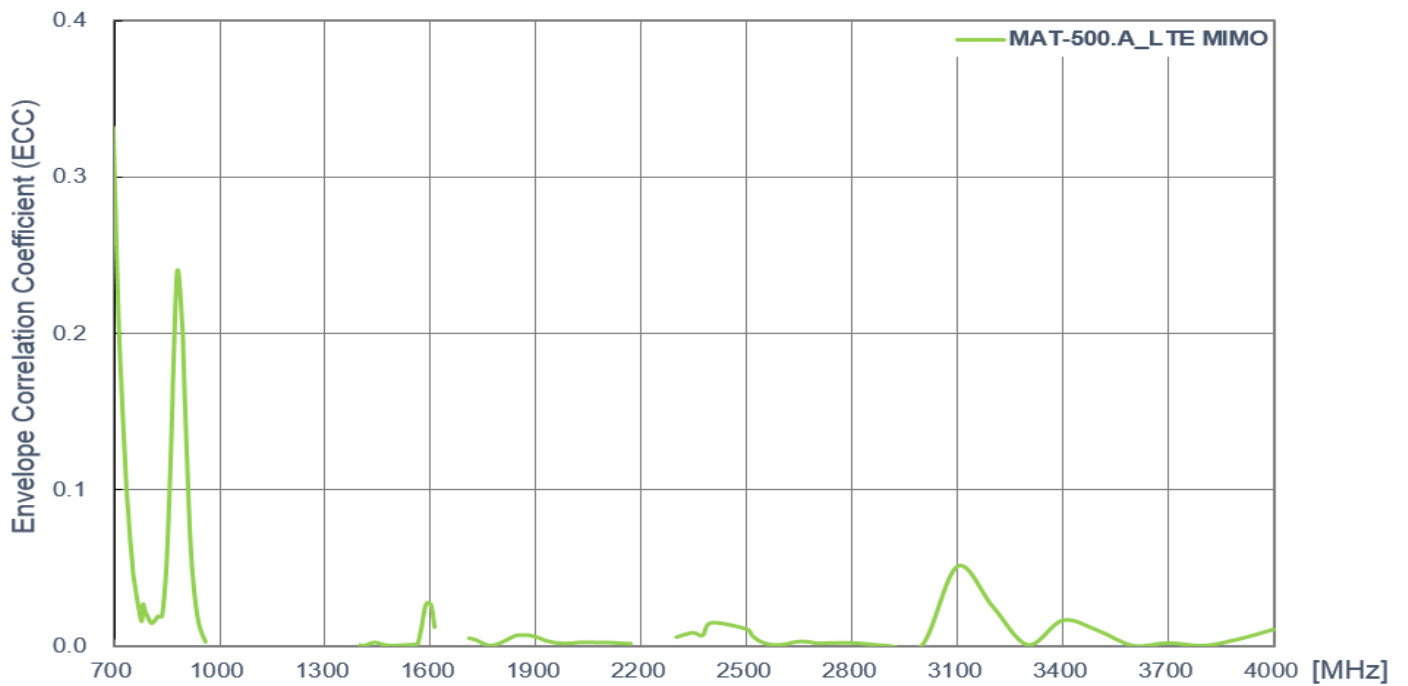

3.3.4 LTE Antenna Efficiency

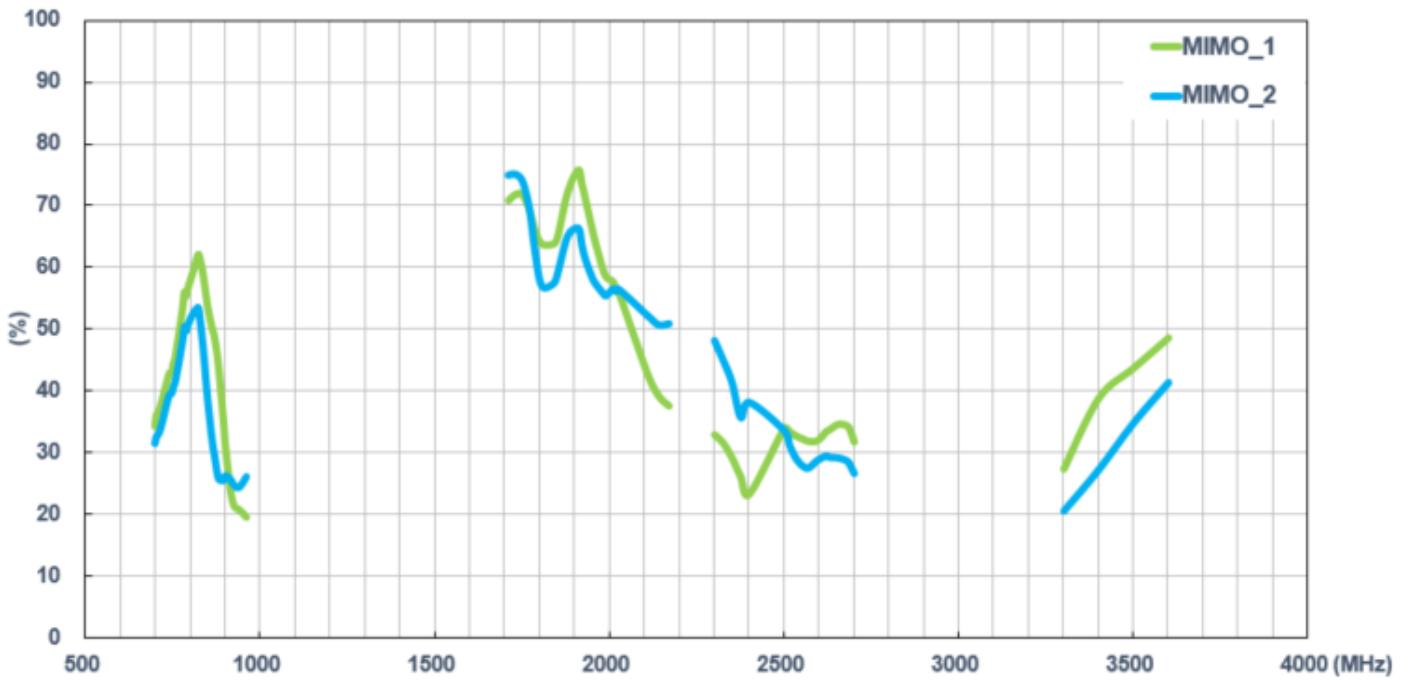

3.3.5 LTE Antenna Peak Gain

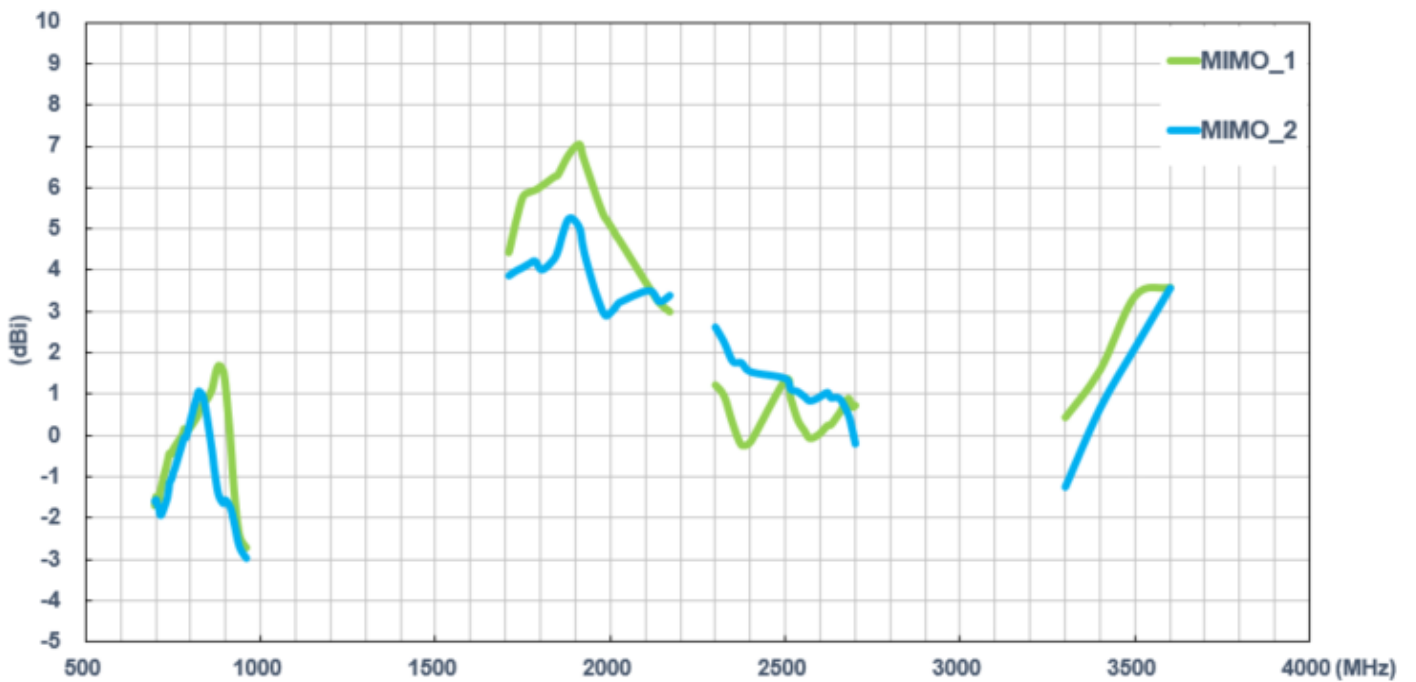

3.3.6 LTE Antenna Average Gain

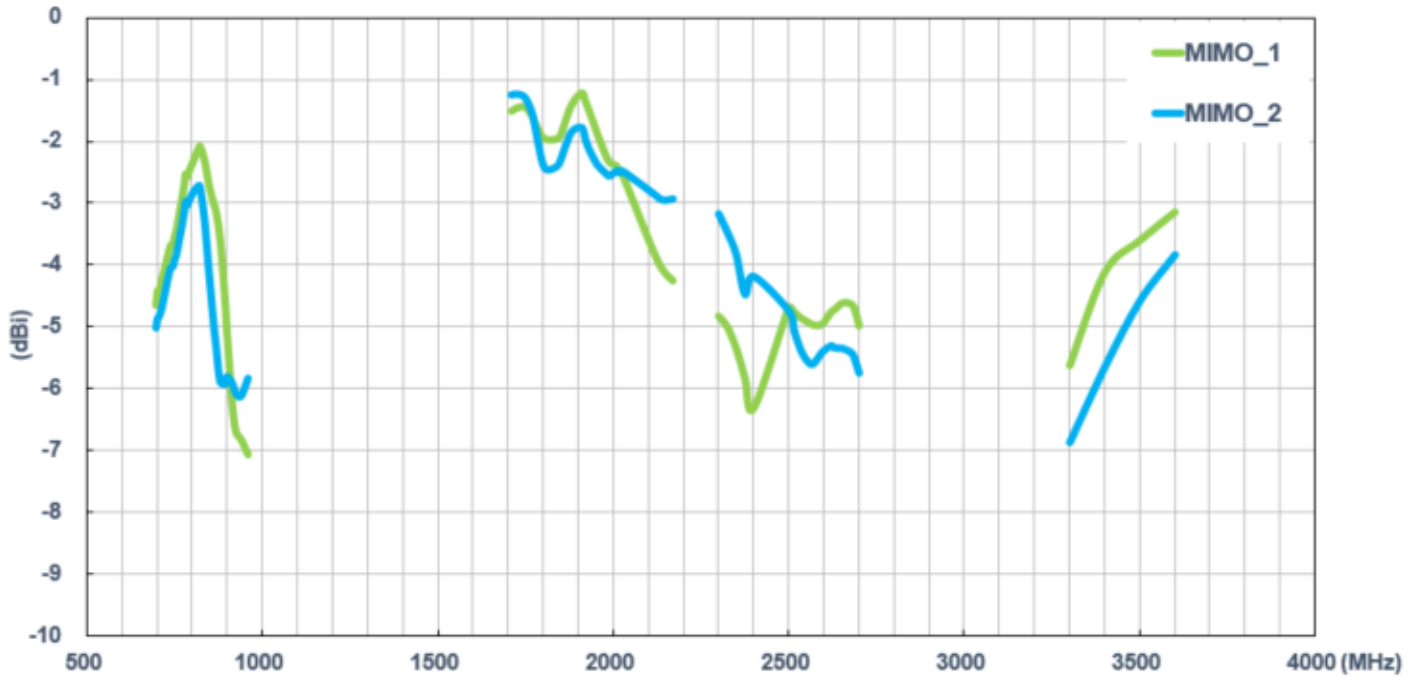

3.3.7 Wi-Fi Antenna Return Loss

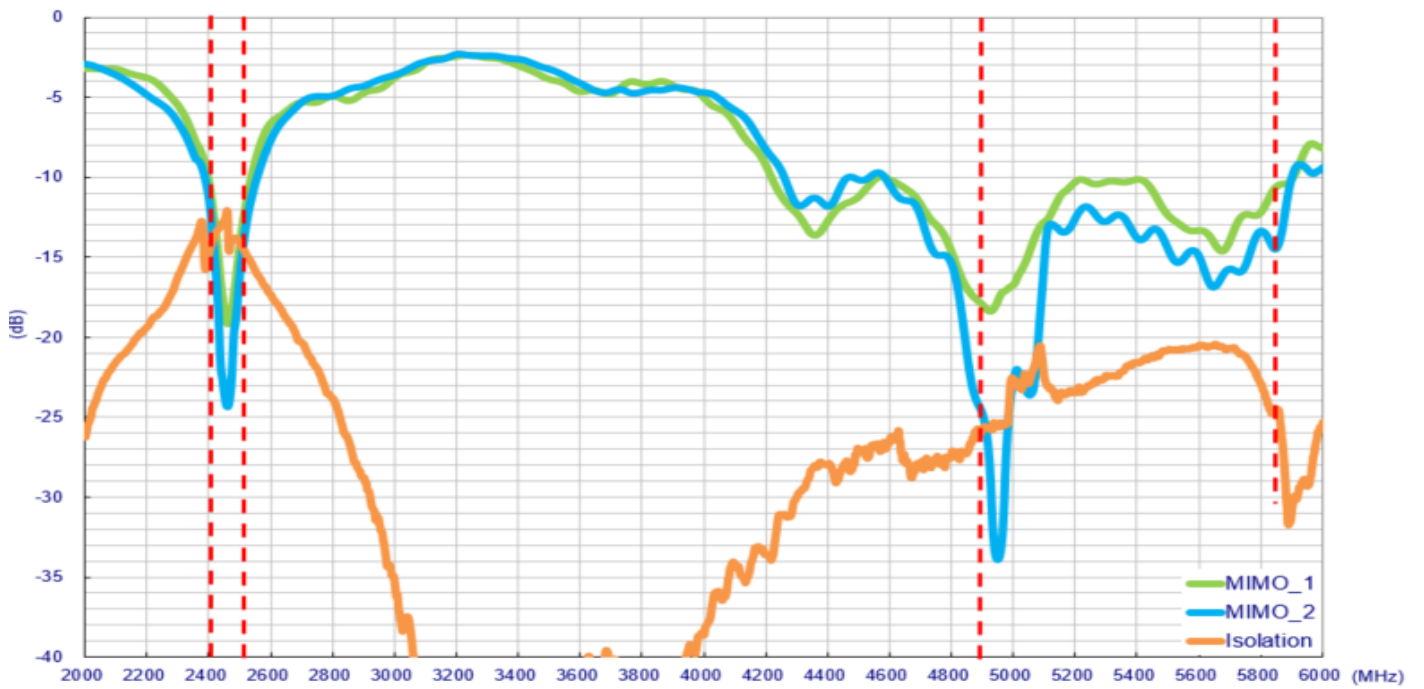

3.3.8 Envelope Correlation Coefficient

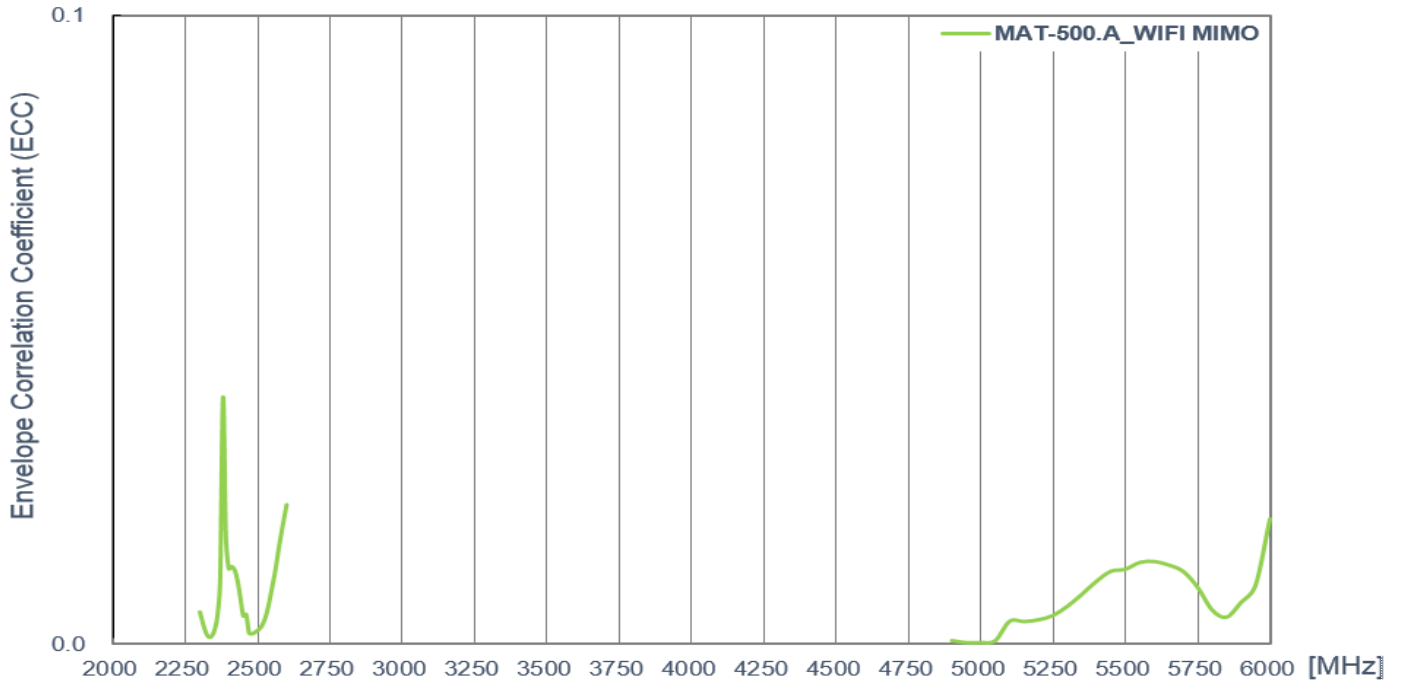

3.3.9 Wi-Fi Antenna Efficiency

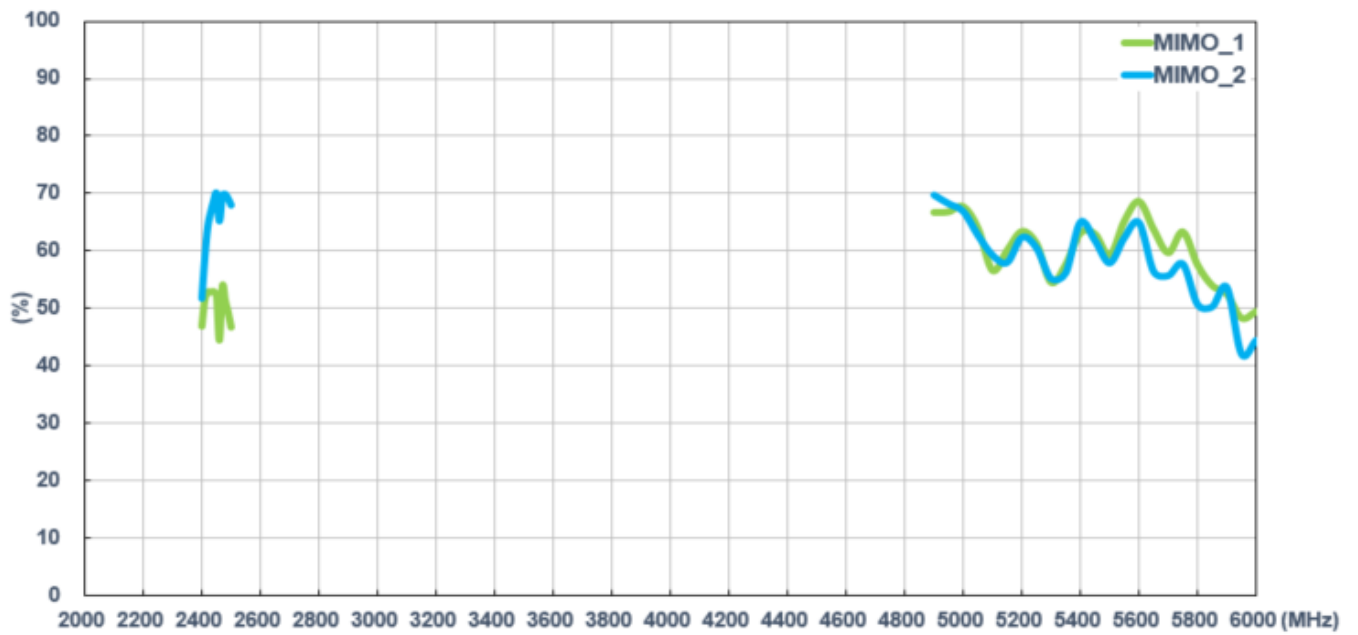

3.3.10 Wi-Fi Antenna Peak Gain

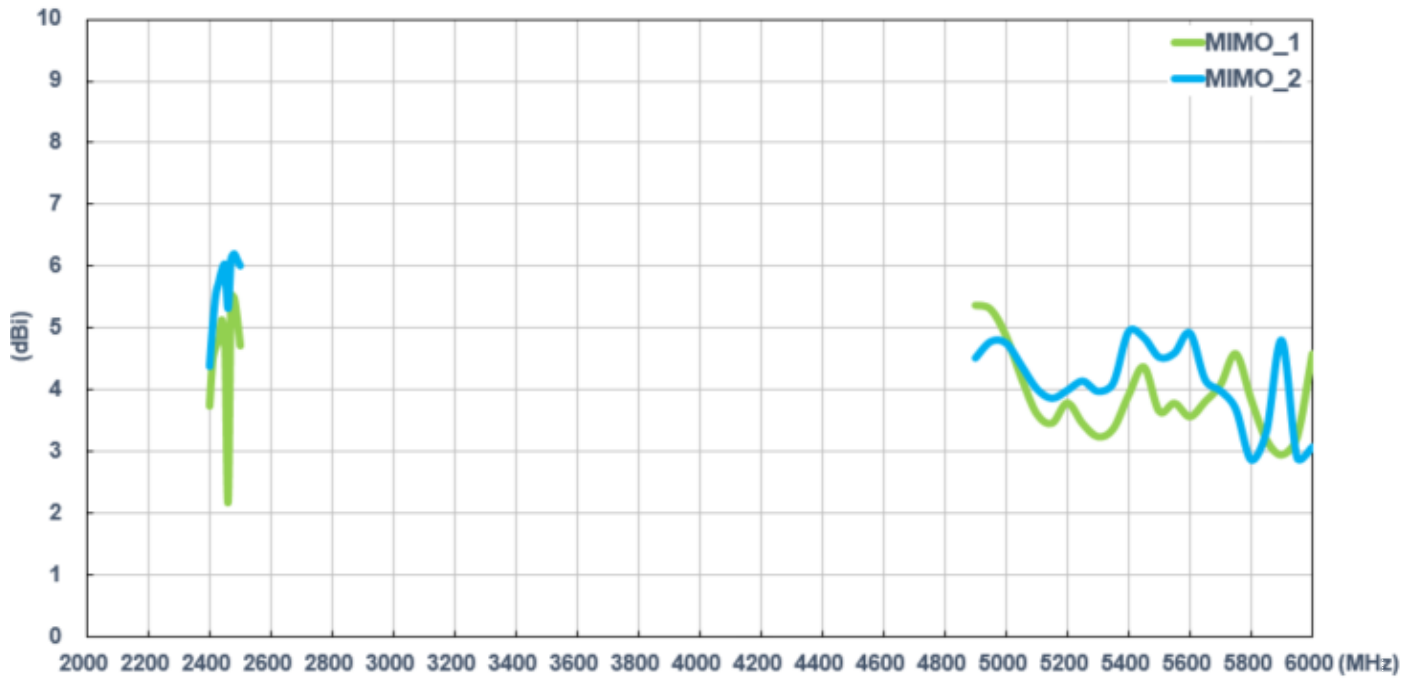

3.3.11 Wi-Fi Antenna Average Gain

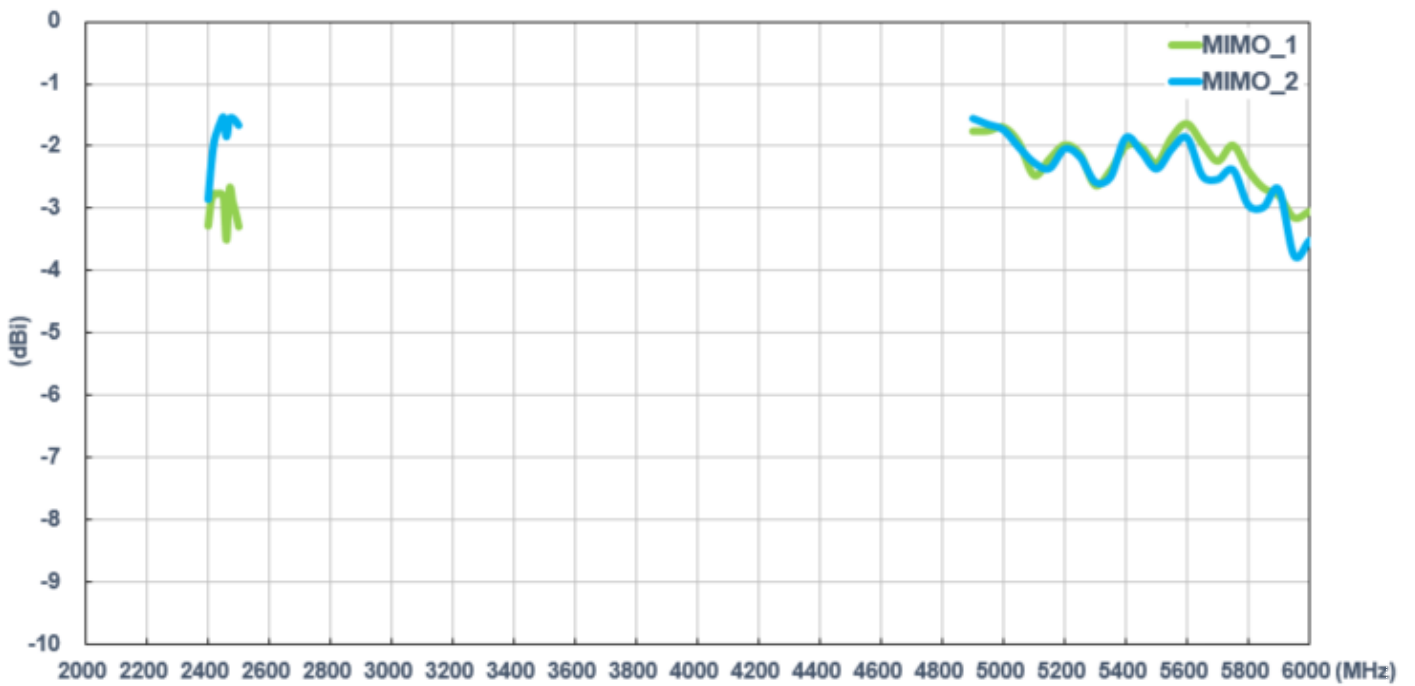

3.3.12 Test Setup For Antenna Radiation Pattern (ETS Anechoic chamber)

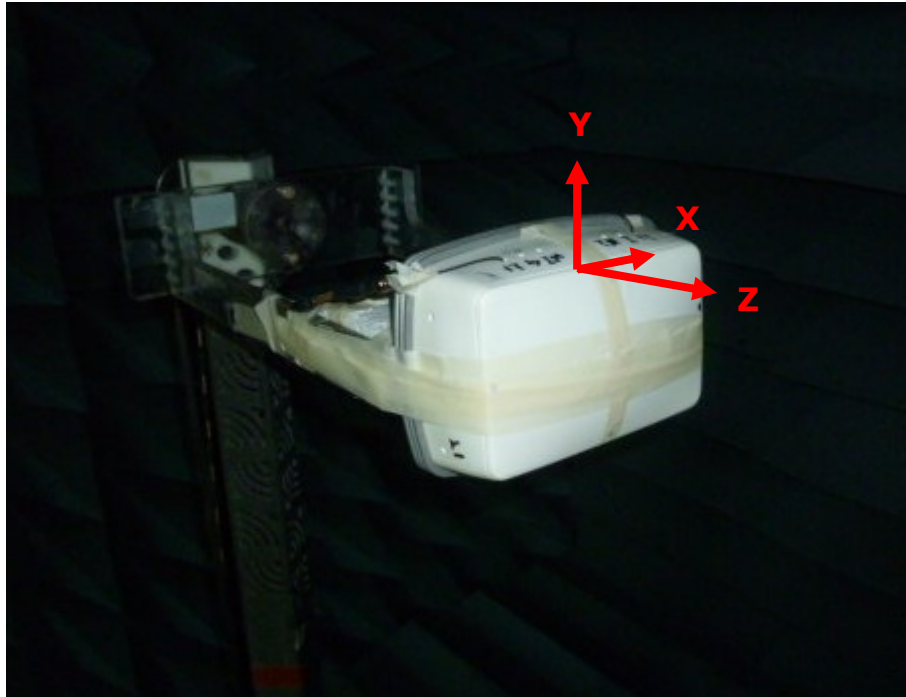

In ZRM50 Housing

3.3.13 2D Radiation Pattern (LTE_MIMO1)

XY Plane

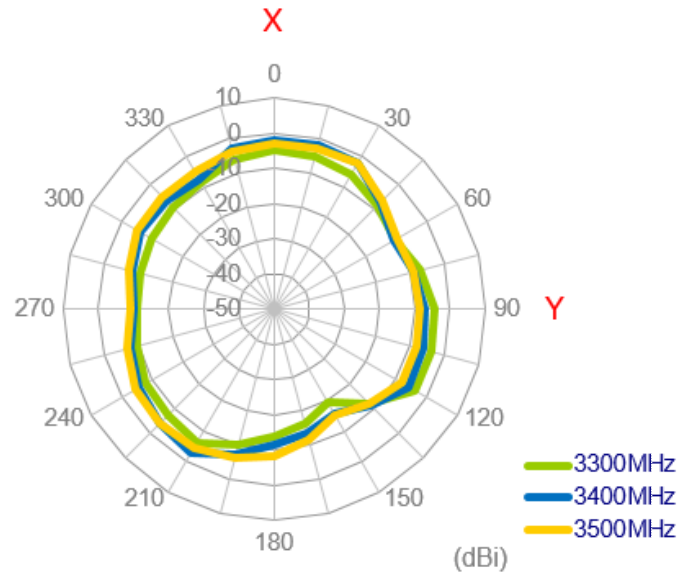
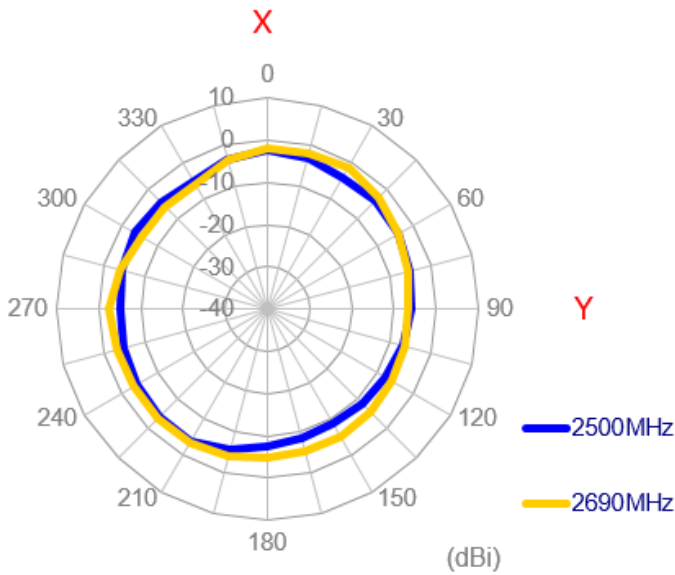
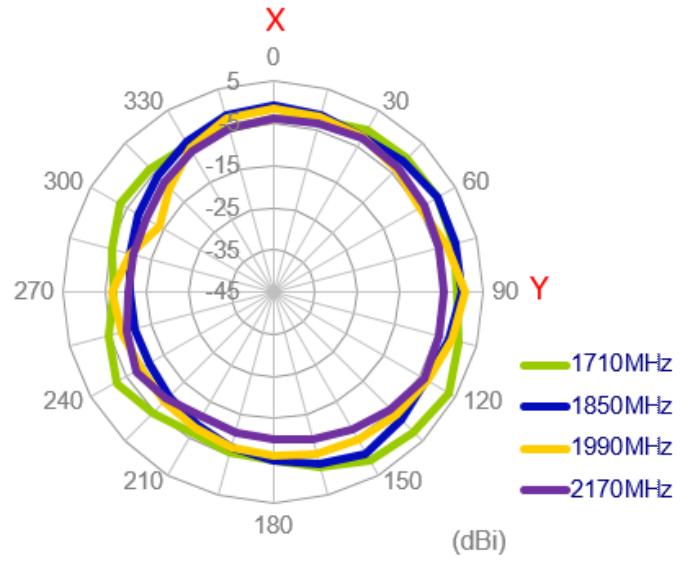
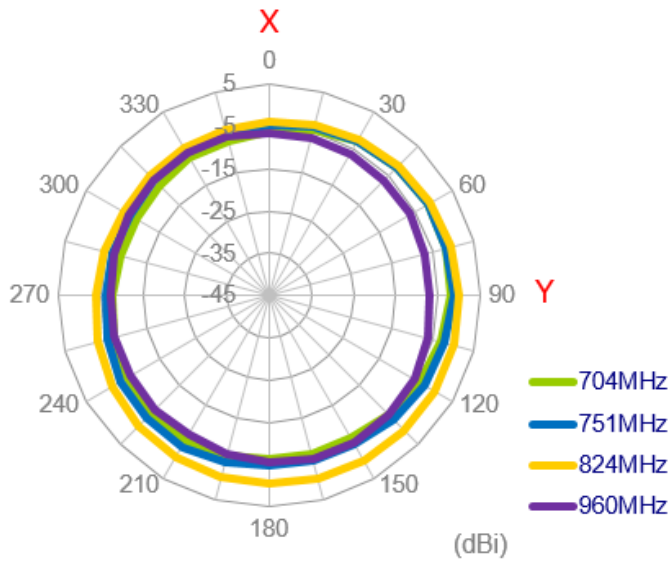

XZ Plane

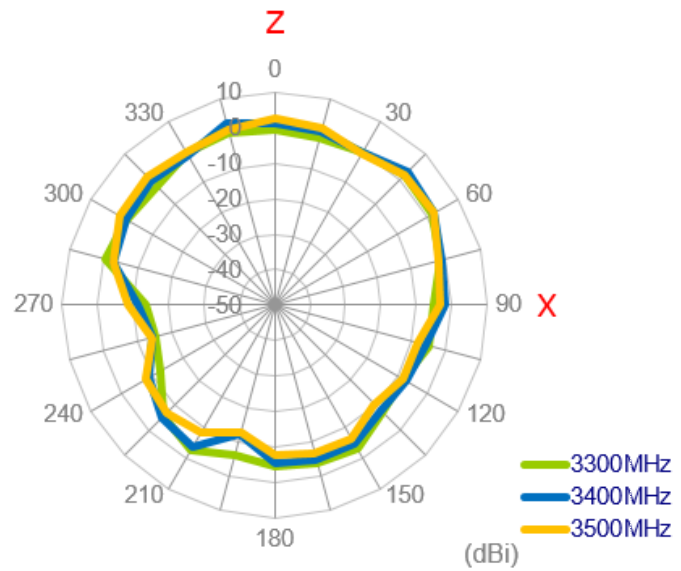
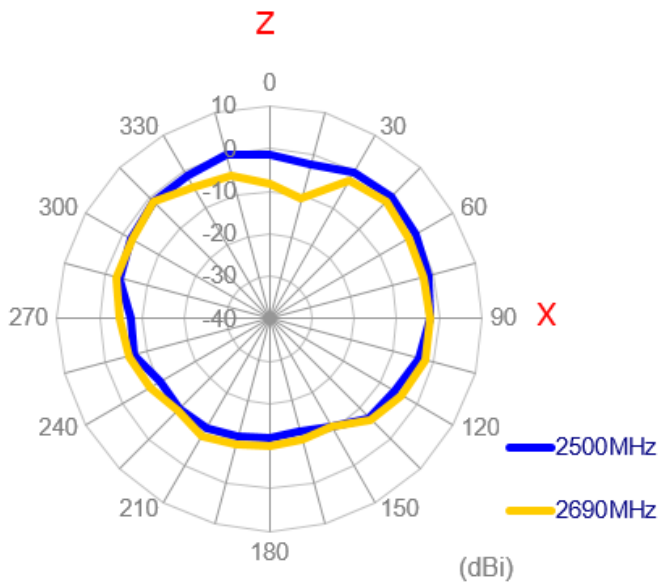
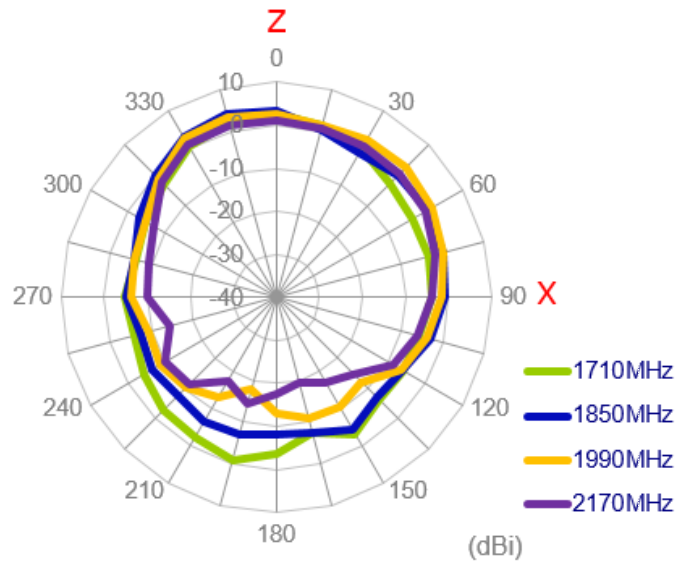
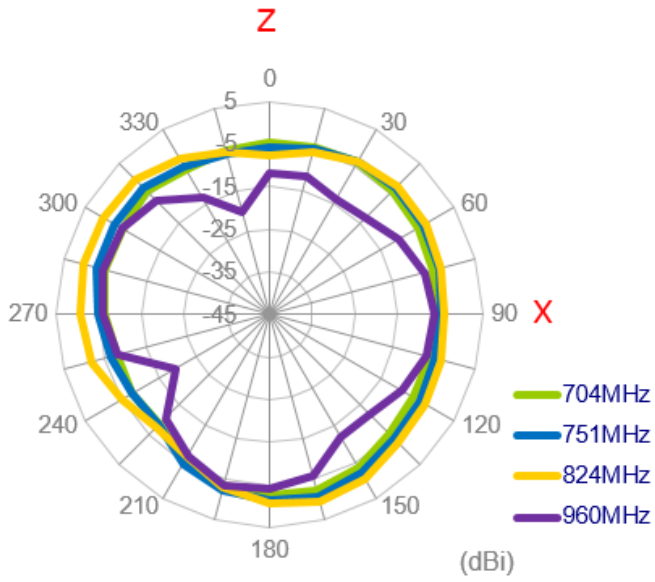

YZ Plane

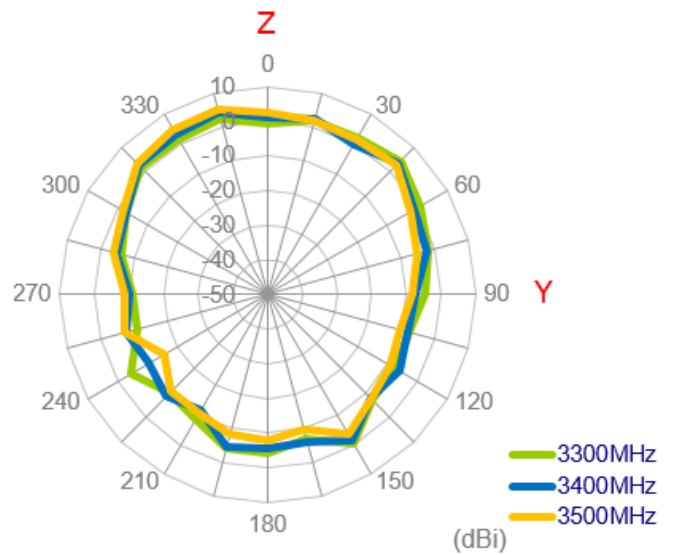
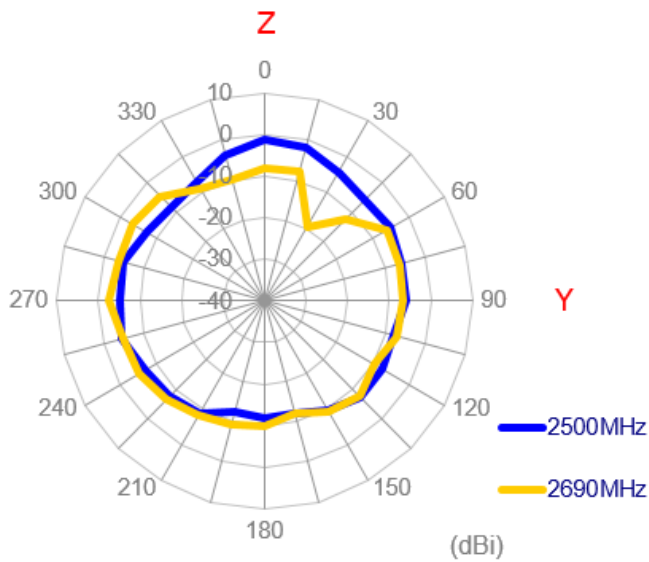
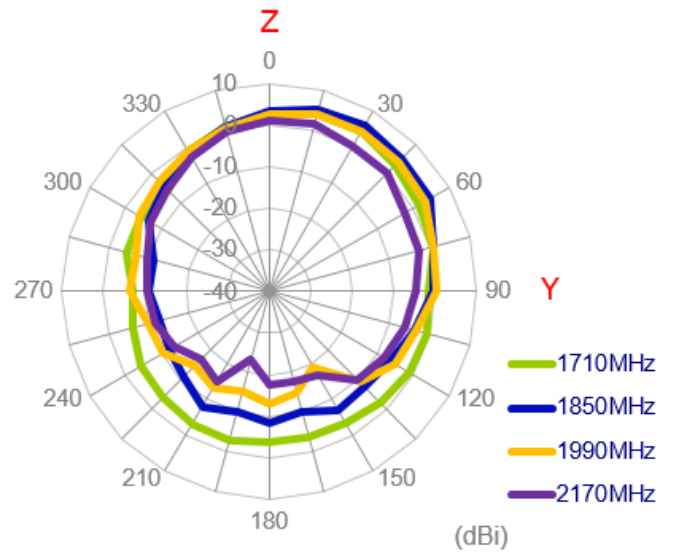
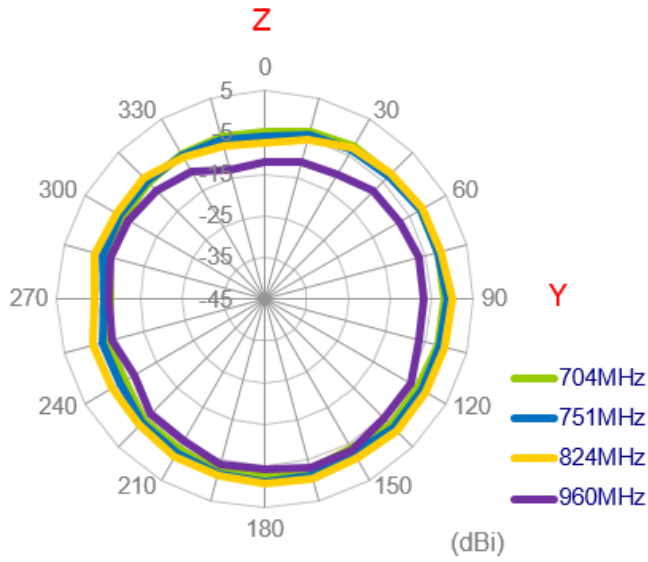

3.3.14 3D Radiation Pattern (LTE_MIMO1)

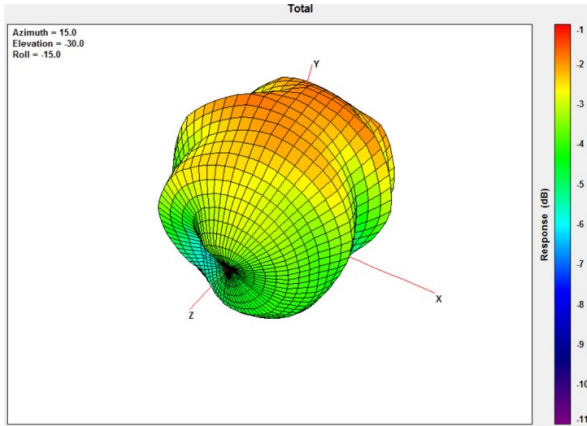

704MHz

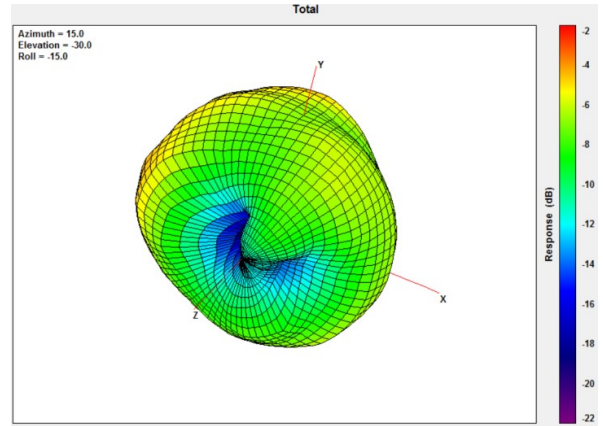

960MHz

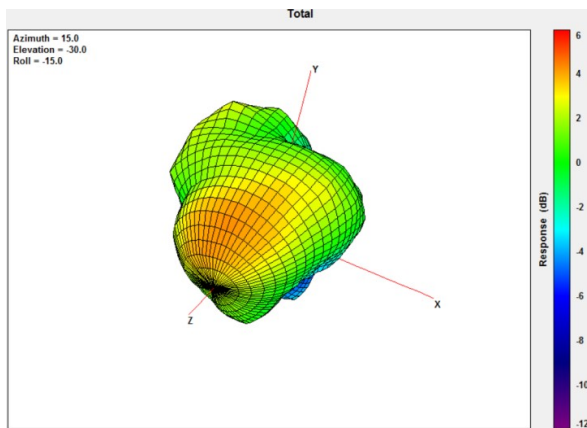

1710MHz

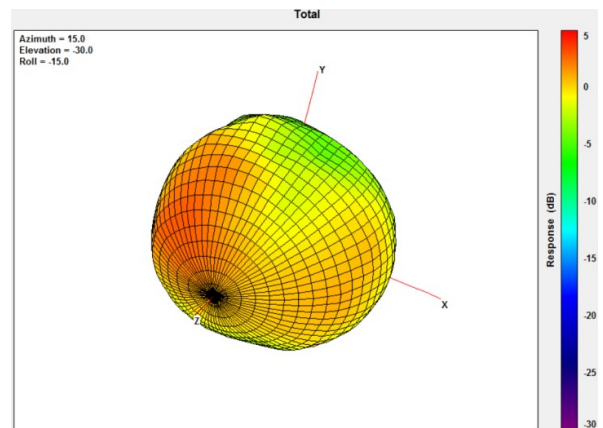

2170MHz

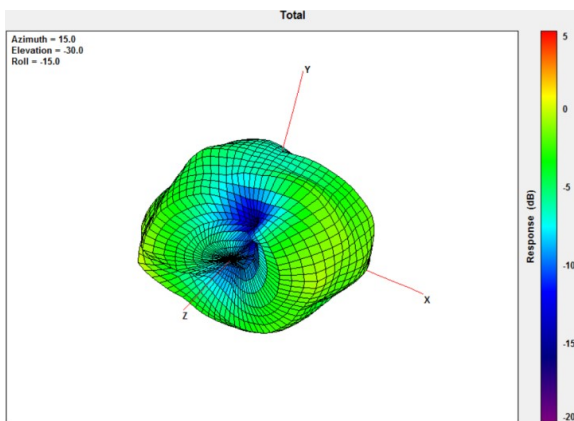

2690MHz

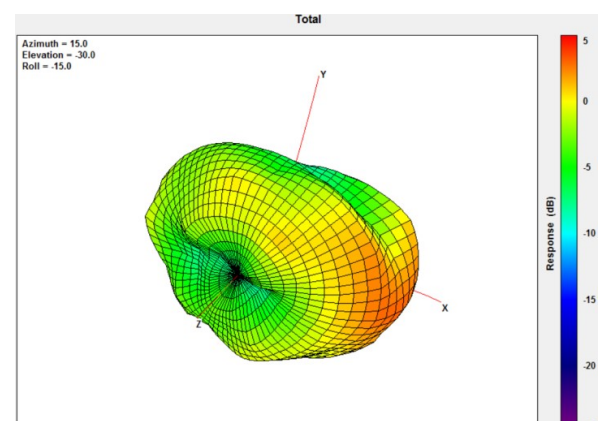

3500MHz

3.3.15 2D Radiation Pattern (LTE_MIMO2)

XY Plane

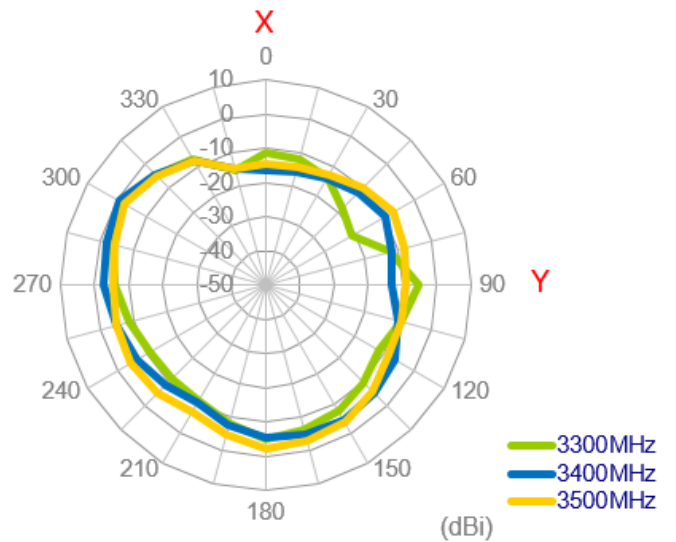
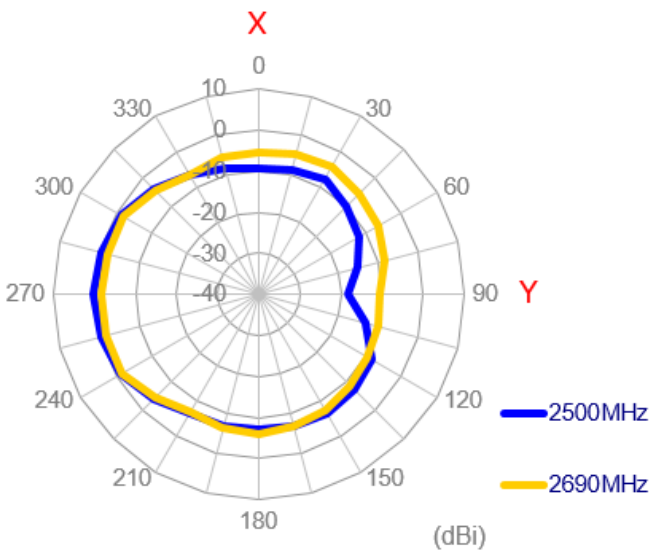
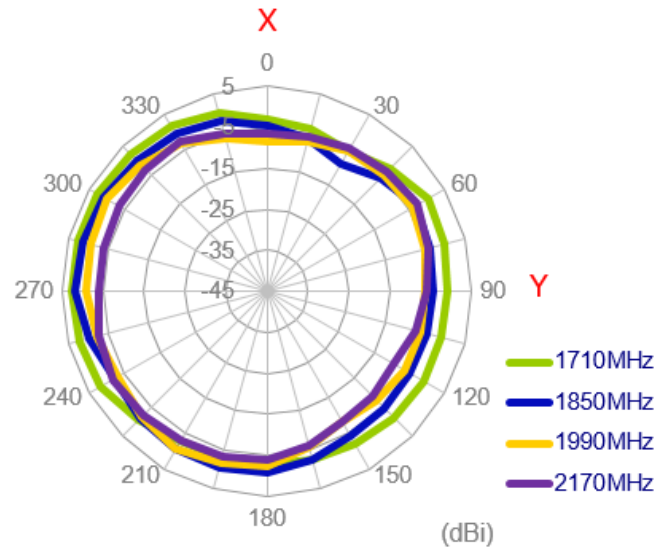
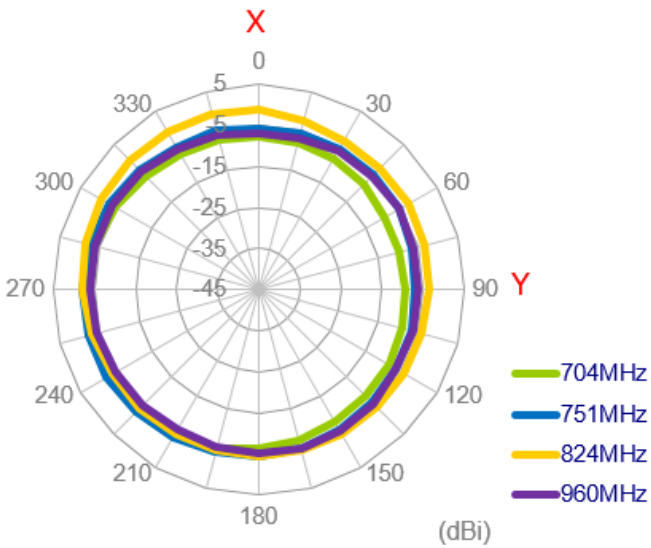

XZ Plane

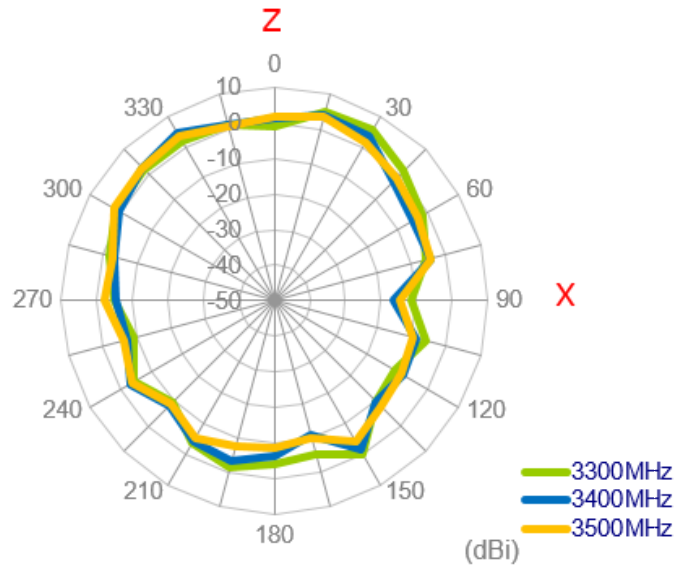
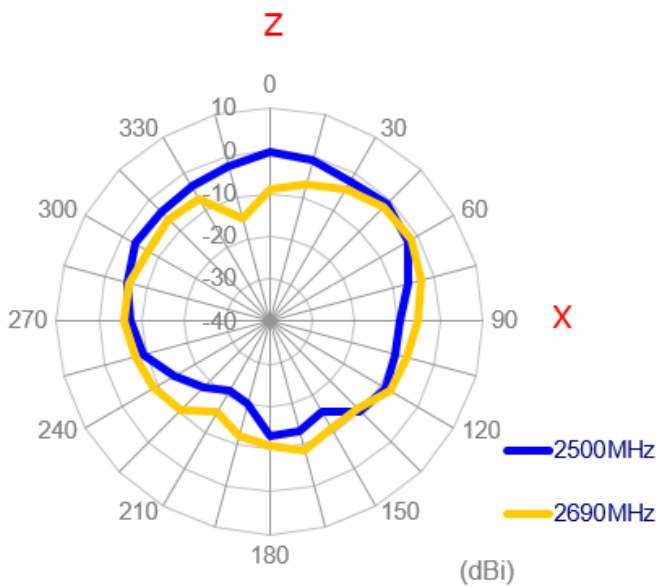
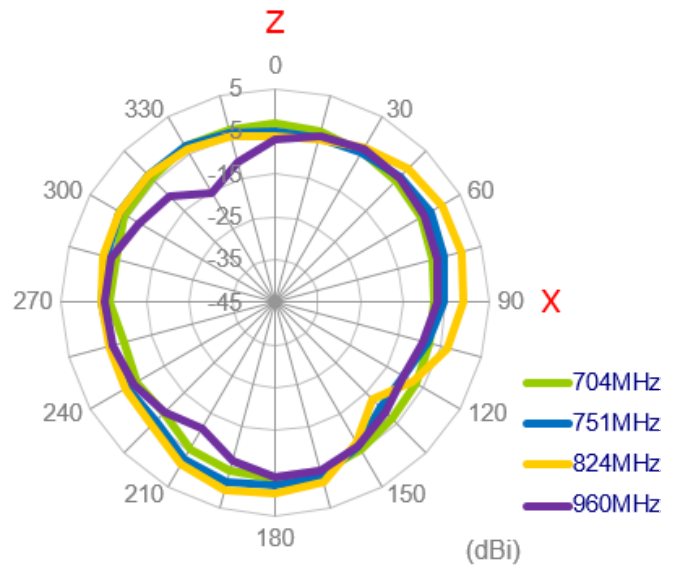
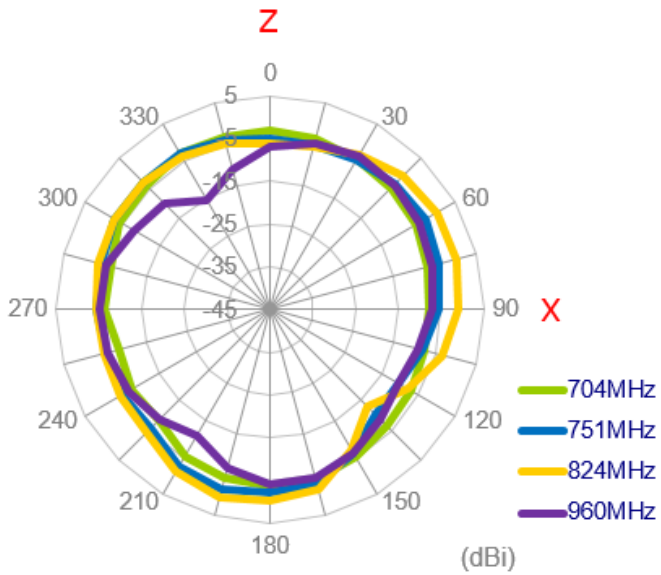

YZ Plane

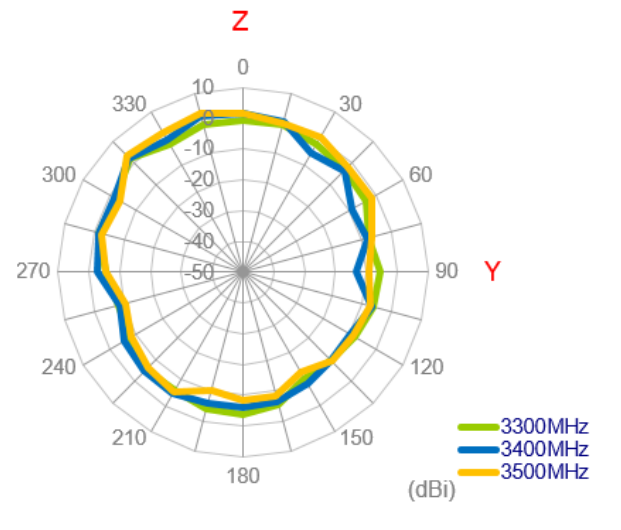
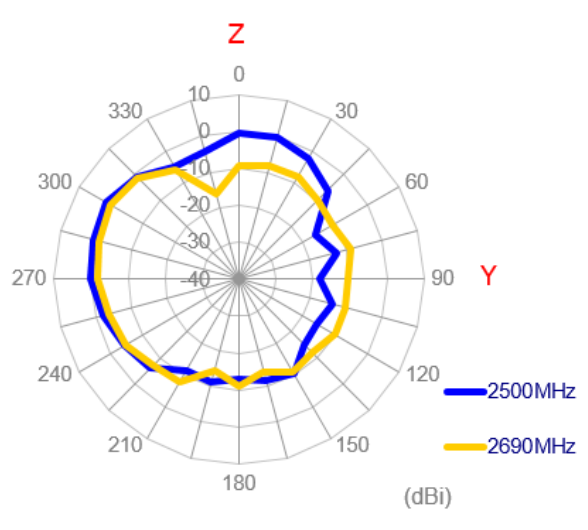
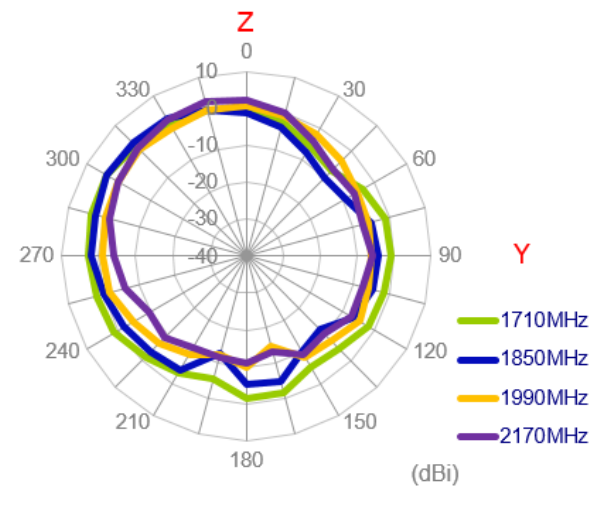
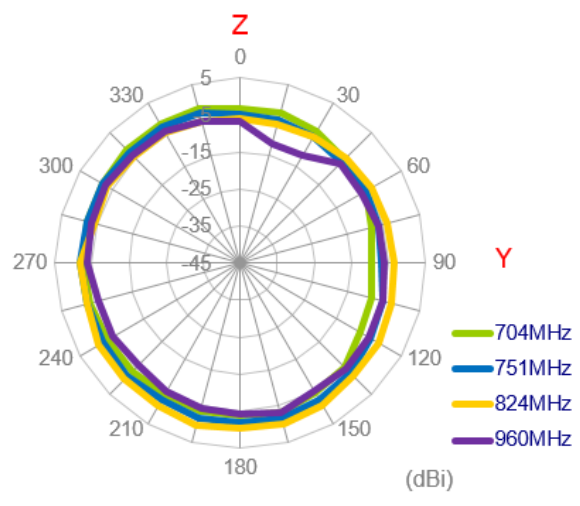

3.3.16 3D Radiation Pattern (LTE_MIMO2)

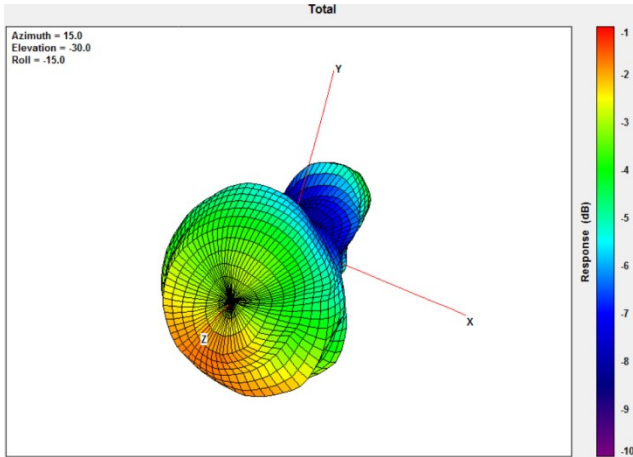

704MHz

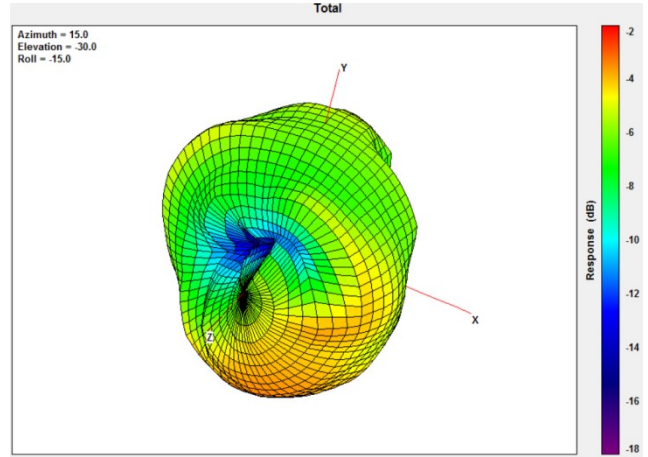

960MHz

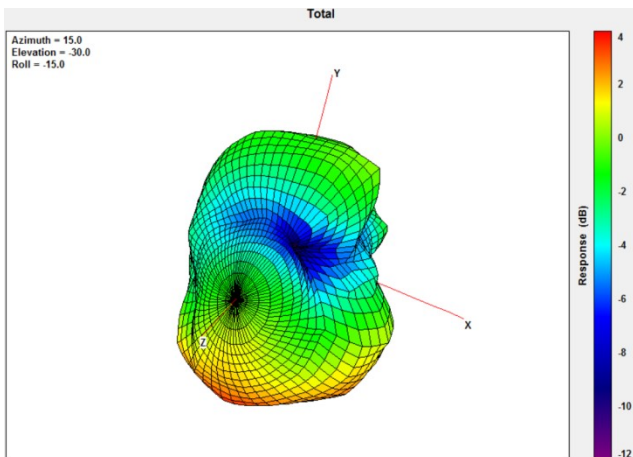

1710MHz

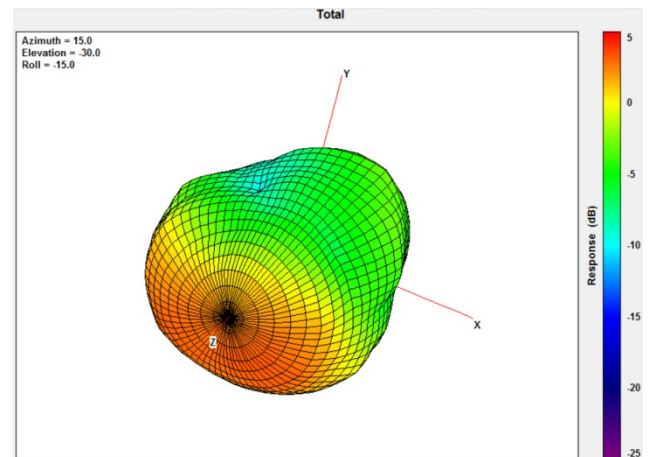

2170MHz

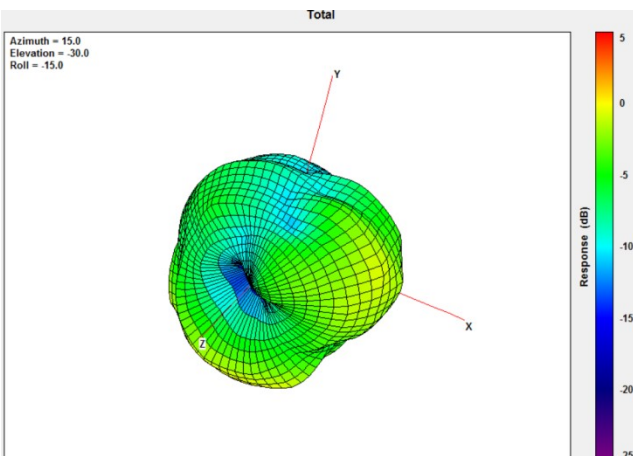

2690MHz

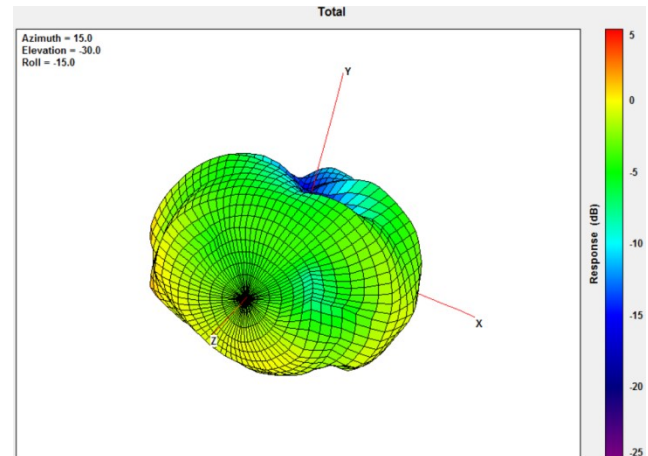

3500MHz

3.3.17 2D Radiation Pattern (Wi-Fi_MIMO1)

XY Plane

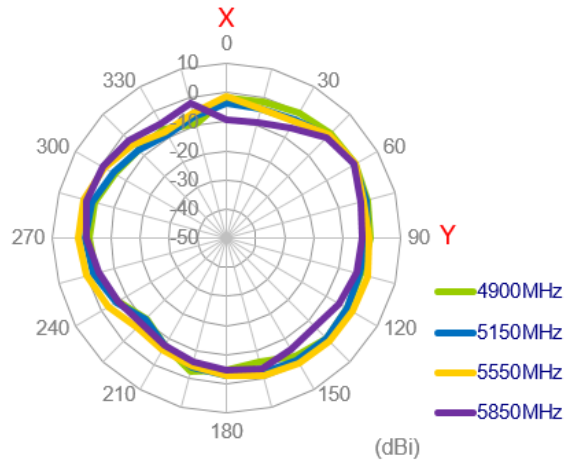
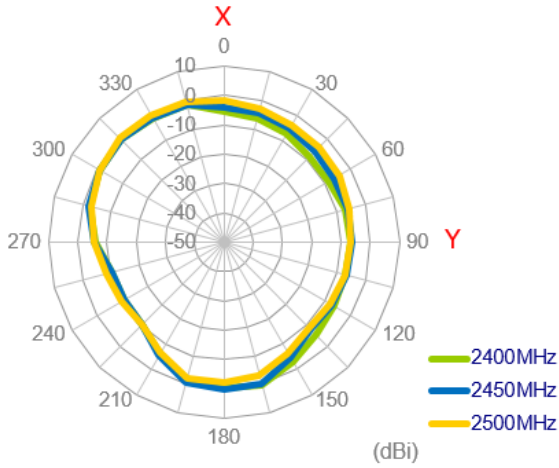

XZ Plane

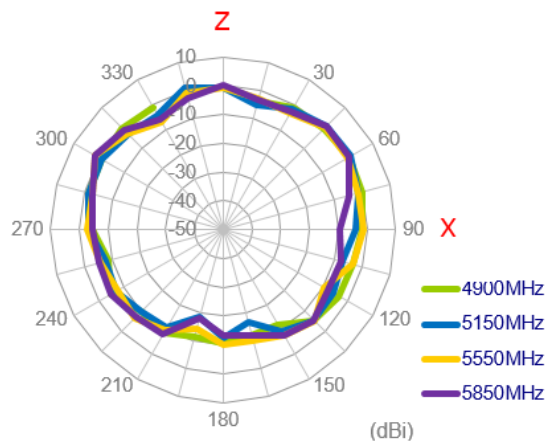
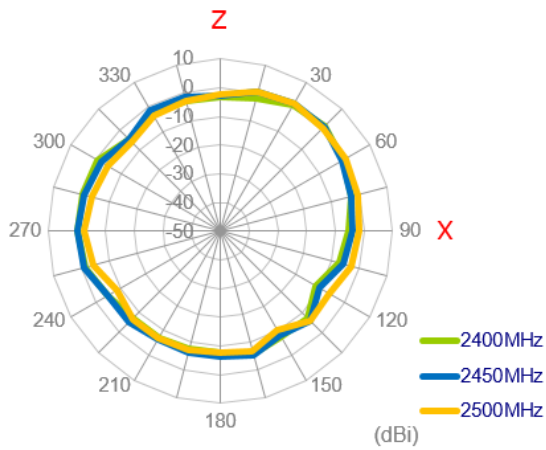

YZ Plane

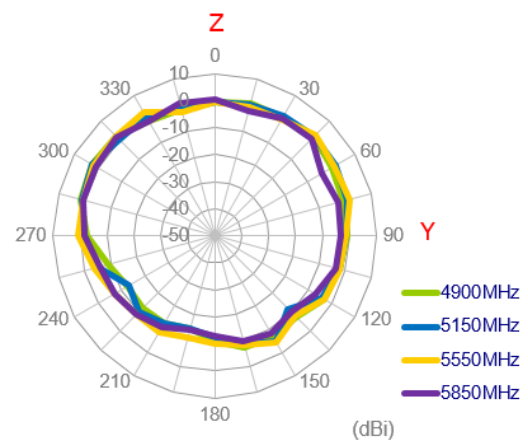
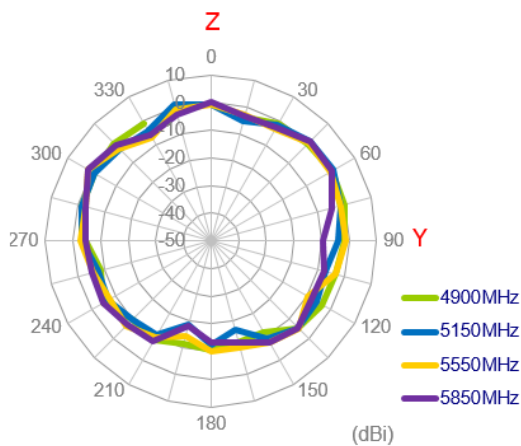

3.3.18 3D Radiation Pattern (Wi-Fi_MIMO1)

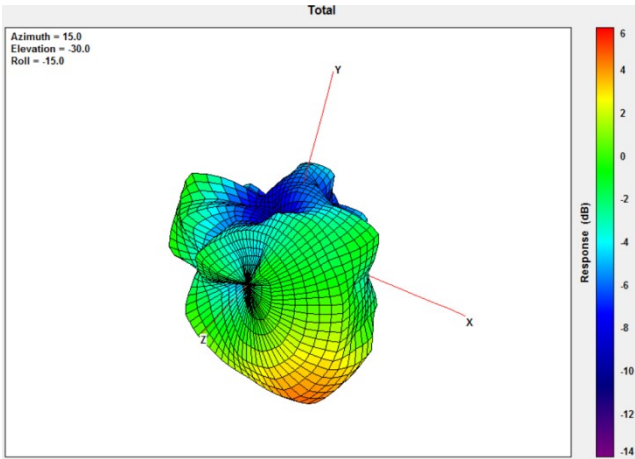

2450MHz

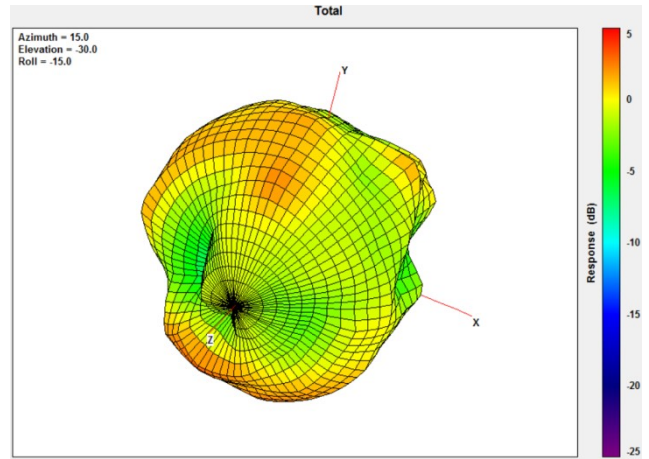

5550MHz

3.3.19 2D Radiation Pattern (Wi-Fi_MIMO2)

XY Plane

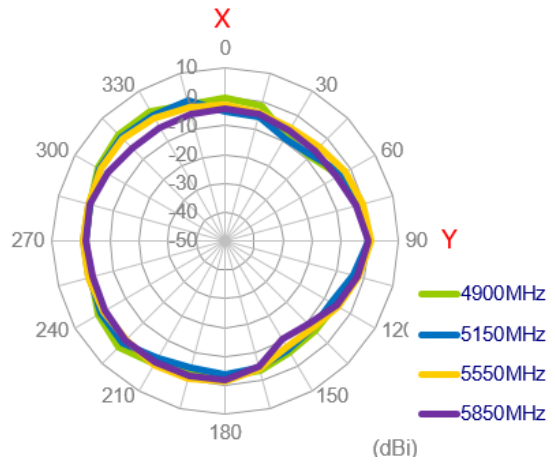
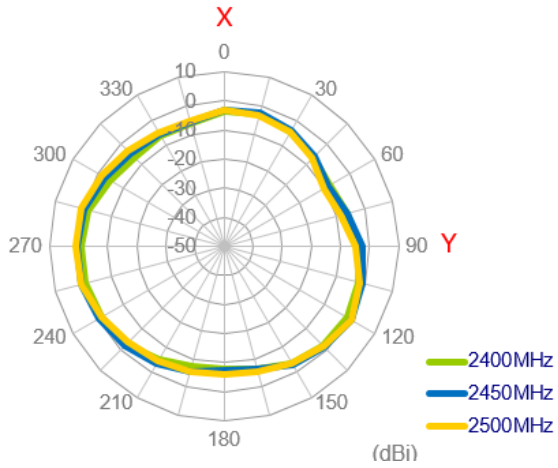

XZ Plane

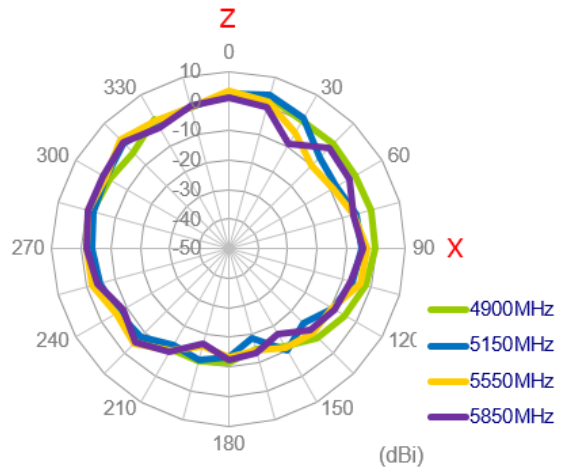
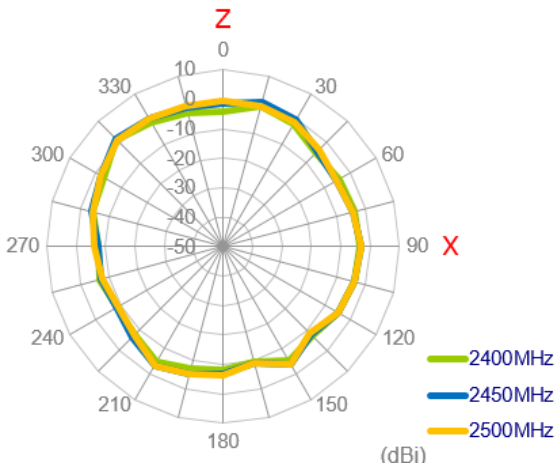

YZ Plane

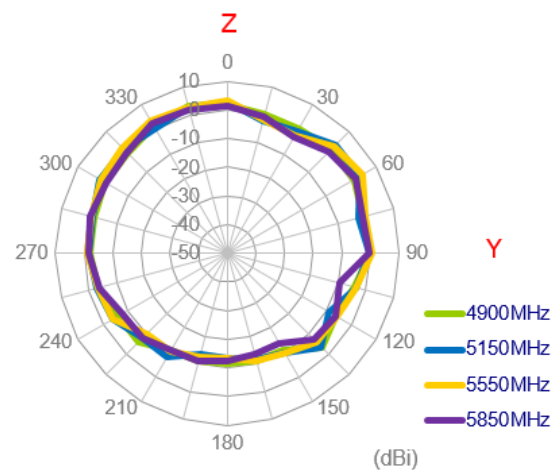
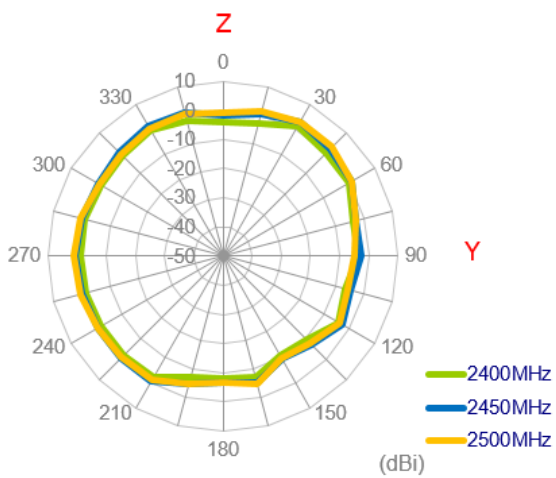

3.3.20 3D Radiation Pattern (Wi-Fi_MIMO2)

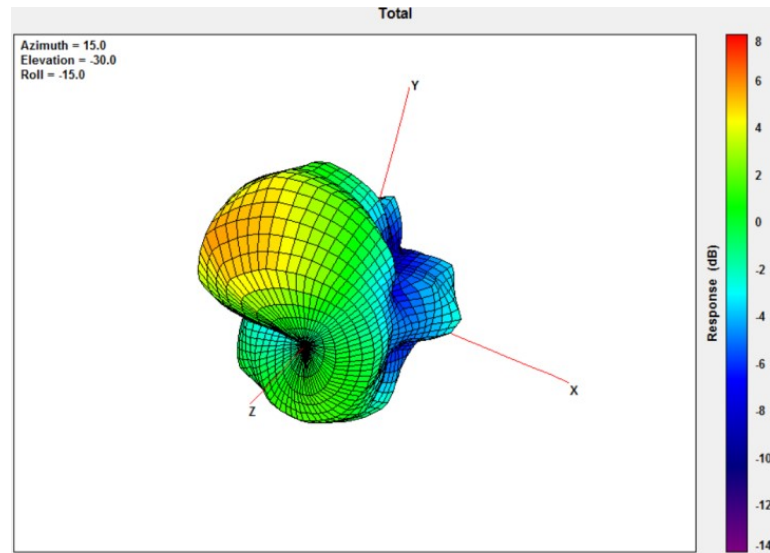

2450MHz

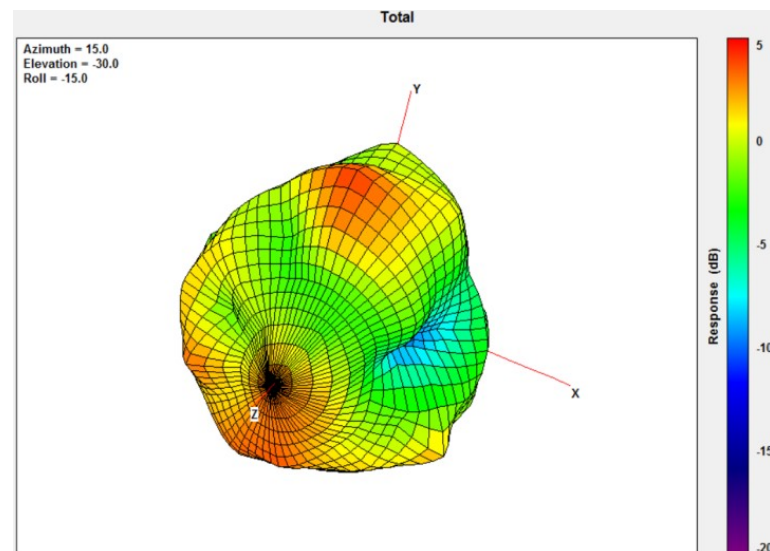

5550MHz

4. Mechanical Drawing (Unit: mm)

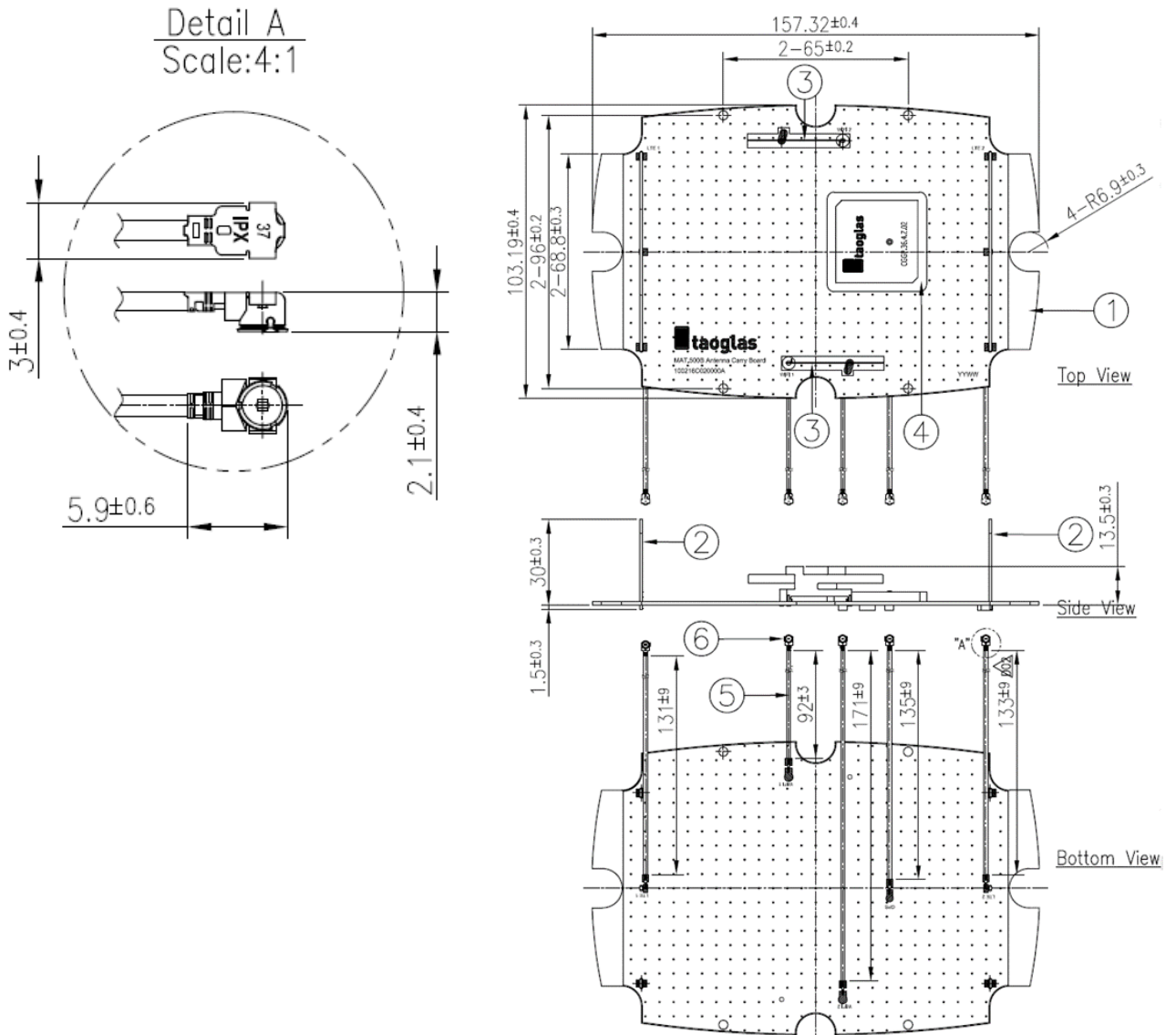

	Name	P/N	Material	Finish	QTY
1	MAT.500B Antenna Carry Board	100216C020000A	Composite t=1.0	Black	1
2	MAT.500 LTE Antenna Board	100216C030000A	Composite t=1.0	Black	2
3	MAT.500 WiFi Antenna	000515A000095A	Cu-Ni-Zn Alloy,t=0.25	N/A	2
4	GNSS Antenna (36x36x4)	CGGP.36.4.Z.02	Ceramic patch	Clear	1
5	1.37 Coaxial Cable	300515C010000A	FEP	Black	5
6	IPEX.MHFHT	204511G000002A	Brass	Au plated	5

6. Packaging

Packaging Specifications

1 pc MAT.500.B per PE bag
 Dimensions - 155*240mm
 Total Weight - 80g

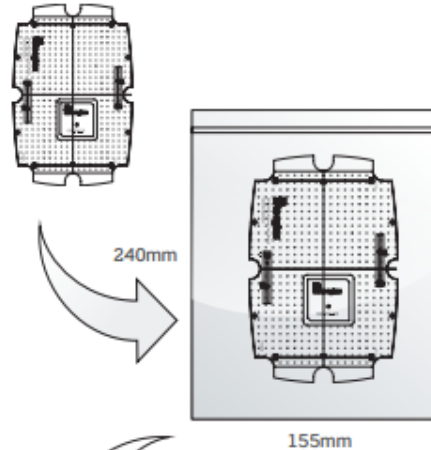

8 pc MAT.500.B per inner carton
 Dimensions - 285*175*120
 Weight - 831g

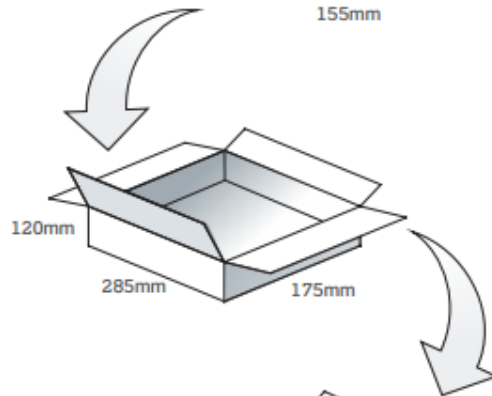

48 pc MAT.500.B per outer carton
 Dimensions - 370*370*300
 Weight - 5Kg

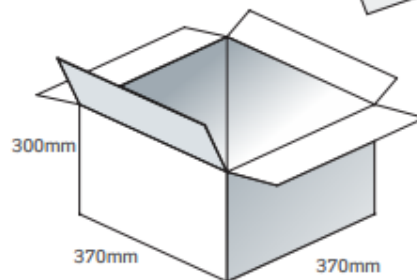

Pallet Dimensions 1200mm*1000mm*1360mm
 24 Cartons per pallet
 6 Cartons per layer
 4 Layers

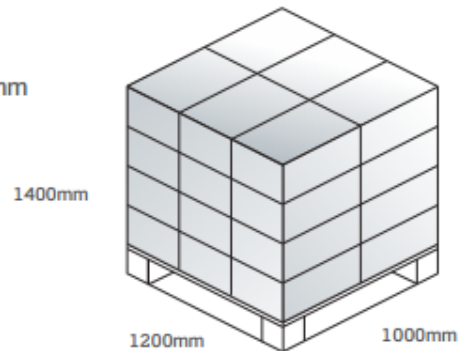

Taoglas makes no warranties based on the accuracy or completeness of the contents of this document and reserves the right to make changes to specifications and product descriptions at any time without notice.

Taoglas reserves the rights to this document and the information contained herein. Reproduction, use or disclosure to third parties without express permission is strictly prohibited.

Copyright © Taoglas Ltd.