



Thin-Film Cascadable Amplifier 500 to 2000 MHz

Technical Data

UTO/UTC 2013 Series

Features

- **Frequency Range: 500 to 2000 MHz**
- **High Dynamic Range**
- **High Output Power: +21.0 dBm (Typ)**
- **GaAs FET Technology**
- **Temperature Compensated**
- **Surface Mount Option**

Applications

- **System Front End**
- **Output Stage**
- **Surface Mount Assembly**

Description

The 2013 Series is a thin-film high power GaAs FET RF amplifier using active bias and resistive feedback for stability over temperature and bias voltage variations. Input/output blocking capacitors couple RF through the amplifier, while a low VSWR is maintained through inductive tuning. The 2013 Series amplifiers are available in three packages: the surface mount PlanarPak PP-38 (.375 in. x .375 in.) case, the TO-8 hermetic case and the connectorized TC-1A case.

Pin Configuration

UTO—TO-8U

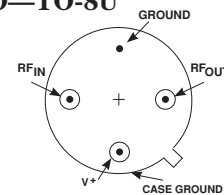

UTC—TC-1A

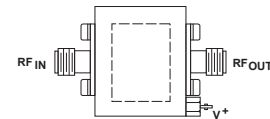

Schematic

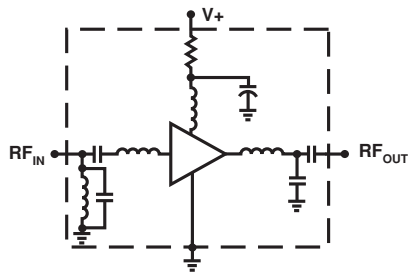

Maximum Ratings

Parameter	Maximum
DC Voltage	+17 Volts
Continuous RF Input Power	+17 dBm
Operating Case Temperature	-55 to +100°C
Storage Temperature	-62 to +150°C
"R" Series Burn-In Temperature	+100°C

Thermal Characteristics¹

θ_{JC}	60°C/W
Active Transistor Power Dissipation	900 mW
Junction Temperature Above Case Temperature	54°C
MTBF (MIL-HDBK-217E, A_{UF} @ 90°C)	361,600 Hrs.

Weight: (typical) PPA—0.5 grams; UTO—2.1 grams; UTC—21.5 grams

Electrical Specifications¹

(Measured in 50 Ω system @ +15 VDC nominal unless otherwise noted)

Symbol	Characteristic	Typical $T_C = 25^\circ\text{C}$	Guaranteed Specifications		Unit
			$T_C = 0$ to 50°C	$T_C = -55$ to $+85^\circ\text{C}$	
BW	Frequency Range	500-2000	500-2000	500-2000	MHz
GP	Small Signal Gain (Min.)	10.0	9.0	8.5	dB
—	Gain Flatness (Max.)	± 0.5	± 1.0	± 1.0	dB
NF	Noise Figure (Max.)	4.5	5.5	6.0	dB
P _{1dB}	Power Output @ +1 dB Comp. (Min.)	+21.0	+19.0	+18.0	dBm
—	Input VSWR (Max.)	<1.7:1	2.0:1	2.0:1	—
—	Output VSWR (Max.)	<1.6:1	2.0:1	2.0:1	—
IP ₃	Two Tone 3rd Order Intercept Point	+30.0	—	—	dBm
IP ₂	Two Tone 2nd Order Intercept Point	+40.0	—	—	dBm
HP ₂	One Tone 2nd Order Intercept Point	+45.0	—	—	dBm
I _D	DC Current	100	—	—	mA

Note 1: RF input pin at DC ground—no input blocking capacitor.

Typical Performance Over Temperature (@ +15 VDC unless otherwise noted)

Key: +25°C —
+85°C - -
-55°C —

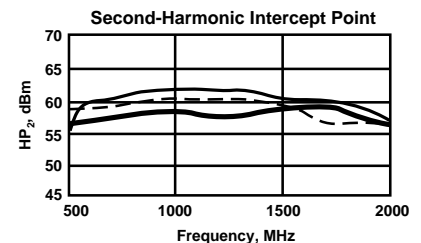
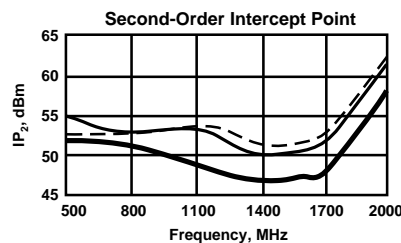
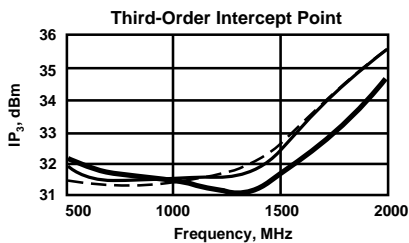
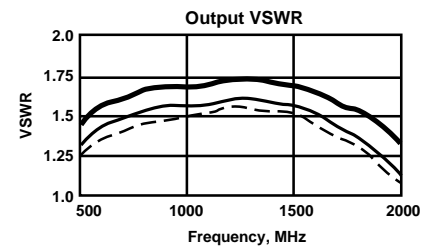
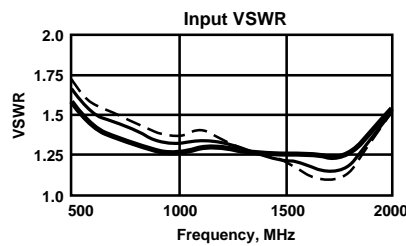
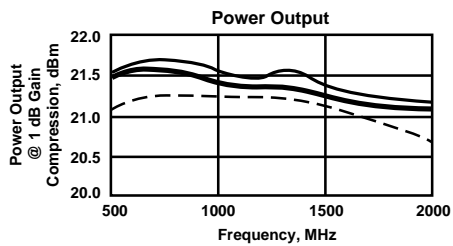
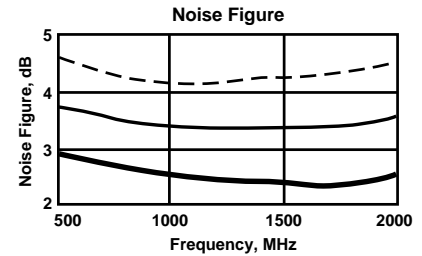
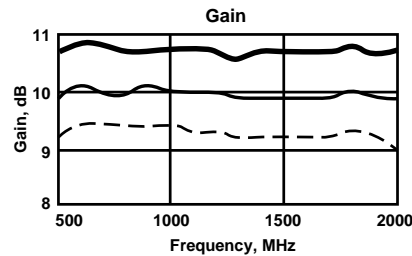

Automatic Network Analyzer Measurements (Typical production unit @ +25°C ambient)

Numerical Readings
Bias = 15.00 Volts

FREQUENCY MHz	VSWR IN	GAIN dB	PHASE DEGREES	PHASE DEV	GROUP DELAY ns	VSWR OUT	ISOLATION dB
400.0	1.58	9.54	-160.92	—	.92	1.39	15.90
500.0	1.28	9.91	170.88	10.08	.69	1.36	16.01
600.0	1.15	10.02	148.57	3.28	.57	1.38	16.14
700.0	1.08	10.03	128.97	-.80	.52	1.42	16.35
800.0	1.09	10.04	111.27	-2.97	.47	1.44	16.53
900.0	1.11	10.13	94.80	-3.92	.43	1.46	16.68
1000.0	1.11	10.20	80.09	-3.11	.40	1.44	16.90
1100.0	1.07	10.20	65.49	-2.18	.42	1.39	17.03
1200.0	1.06	10.18	50.46	-1.70	.41	1.34	17.07
1300.0	1.07	10.15	35.55	-1.08	.42	1.32	17.01
1400.0	1.07	10.19	20.43	-.68	.41	1.32	17.02
1500.0	1.04	10.19	5.46	-.13	.43	1.38	17.00
1800.0	1.06	10.30	-9.46	.45	.39	1.51	17.05
1700.0	1.14	10.23	-23.97	1.46	.42	1.65	17.16
1800.0	1.24	10.16	-38.70	2.24	.43	1.74	17.32
1900.0	1.32	10.12	-55.02	1.45	.45	1.72	17.35
2000.0	1.40	10.21	-71.49	.51	.46	1.68	17.43
2100.0	1.44	10.29	-88.92	—	.52	1.66	17.28

Linearization Range: 500.0 to 2000.0 MHz

S-Parameters
Bias = 15.00 Volts

FREQUENCY MHz	S ₁₁		S ₂₁		S ₁₂		S ₂₂	
	Mag	Ang	dB	Ang	dB	Ang	Mag	Ang
500.00	.199	32.7	10.097	178.2	-17.058	-14.6	.130	-72.6
600.00	.125	19.7	10.257	154.3	-16.560	-29.8	.111	-108.7
700.00	.069	-14.2	10.299	135.3	-16.848	-48.7	.094	-154.8
800.00	.053	-69.5	10.268	117.2	-17.316	-61.4	.093	166.5
900.00	.078	-111.6	10.385	100.5	-17.040	-77.9	.120	145.9
1000.00	.069	-111.9	10.375	86.4	-17.402	-91.4	.114	139.3
1100.00	.103	-109.0	10.296	71.4	-18.034	-105.3	.094	146.7
1200.00	.115	-116.0	10.205	56.0	-17.977	-119.2	.071	146.7
1300.00	.116	-120.1	10.078	40.9	-17.625	-131.8	.048	172.7
1400.00	.111	-135.0	10.045	26.8	-17.854	-143.2	.040	-171.3
1500.00	.098	-144.1	10.015	12.8	-18.129	-156.0	.025	-170.5
1600.00	.071	179.8	10.159	-.1	-17.931	-170.3	.018	115.7
1700.00	.068	134.5	10.142	-14.9	-17.947	177.3	.019	64.0
1800.00	.072	93.3	10.156	-30.8	-18.386	158.1	.013	-38.3
1900.00	.095	66.8	10.091	-47.6	-18.220	145.4	.032	-54.2
2000.00	.110	46.5	9.907	-63.4	-18.194	132.1	.068	-88.7

Product Options

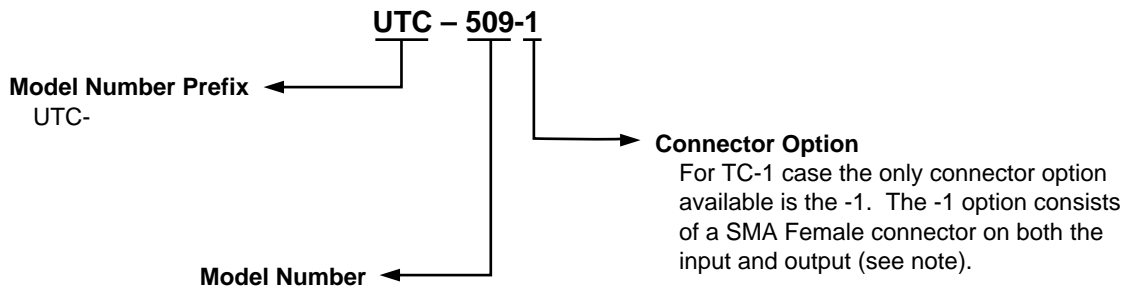
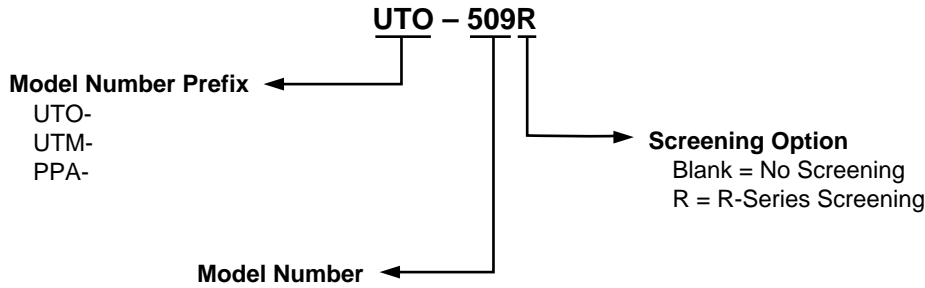

Note: R-Series screening is not available in the TC-1 case as the case is non-hermetic.

Case Drawings TO-8U

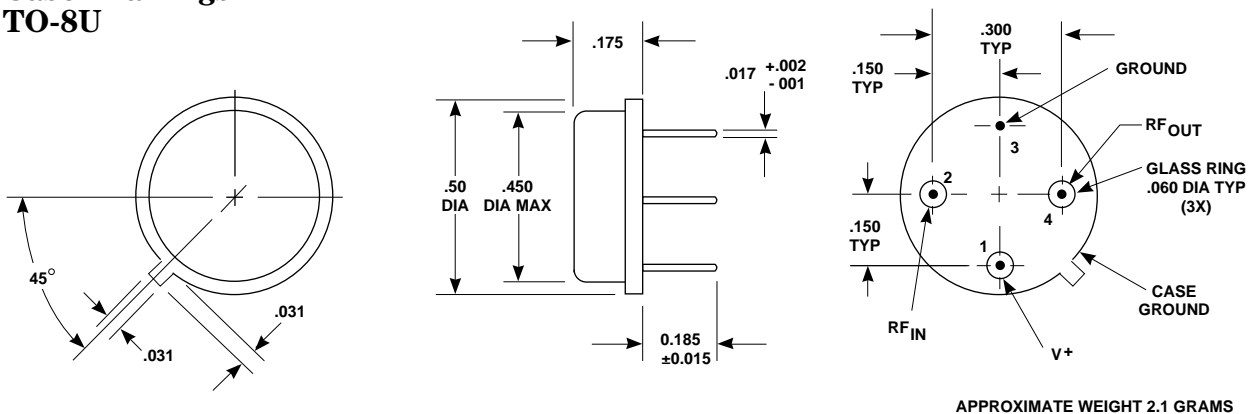

- NOTES (UNLESS OTHERWISE SPECIFIED):
 1. DIMENSIONS ARE SPECIFIED IN INCHES
 2. TOLERANCES: xx ± .02
 xxx ± .010

Case Drawings TC-1

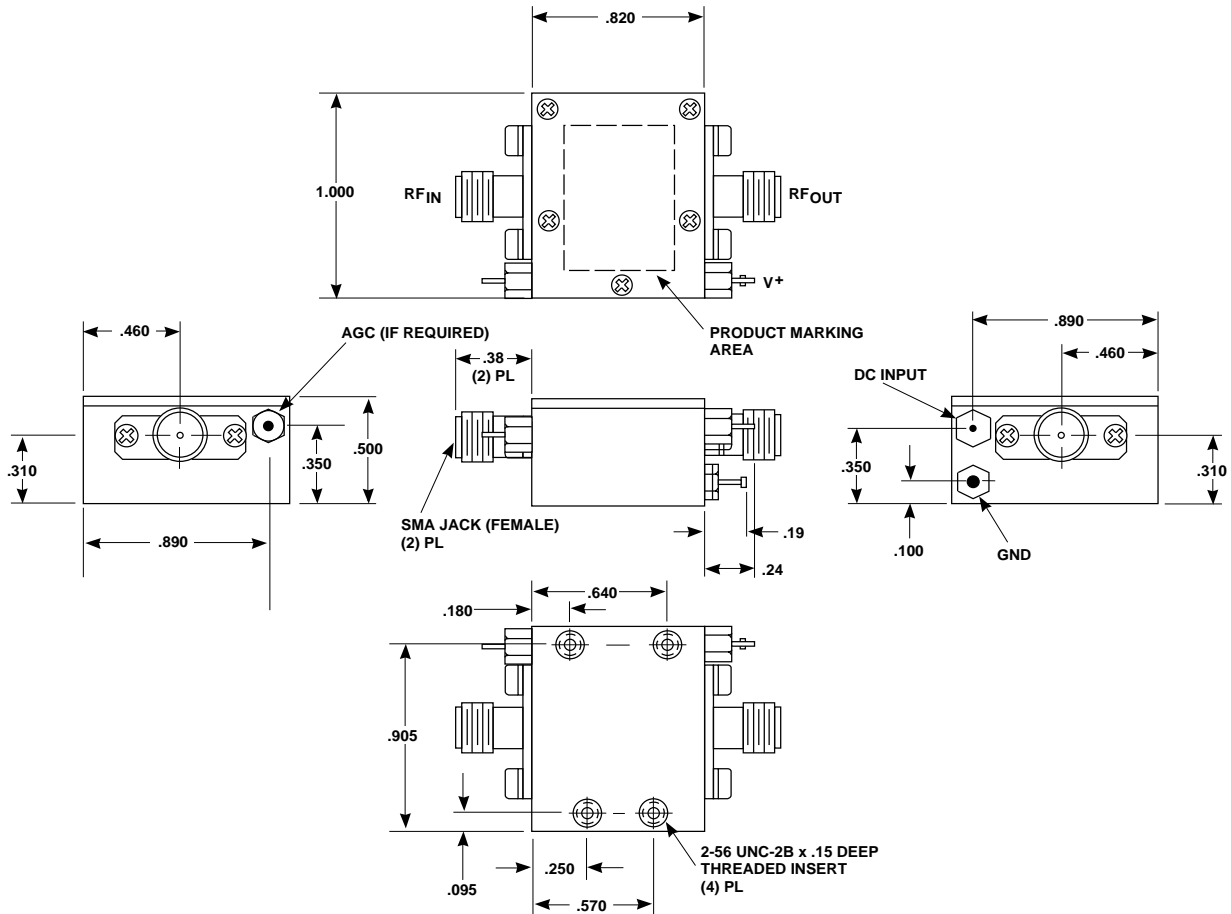

TYPICAL WEIGHT WITH CONNECTORS = 21.5 GRAMS

- NOTES: 1. THE TC-1 CASE IS A NON-HERMETIC CASE.
2. THE ONLY CONNECTOR OPTION AVAILABLE FOR THE TC-1 CASE IS THE -1, SMA FEMALE CONNECTORS AT BOTH INPUT AND OUTPUT PORTS.

- NOTES (UNLESS OTHERWISE SPECIFIED):
1. DIMENSIONS ARE SPECIFIED IN INCHES
2. TOLERANCES: xx ± .02
xxx ± .010

Contact Teledyne Microwave Solutions:
650-691-9800
650-962-6845 fax

Check for updates:
www.teledynemicrowave.com