

BL011

5-4000 MHz Wideband Low Noise Amplifier



Device Features

- NF = 0.91 dB @ 900MHz at RF connectors of Demo board
- Gain = 22.0 dB @ 900 MHz
- OIP3 = 36.0 dBm @ 1900MHz, 38.0 dBm @ 2450MHz
- Output P1 dB = 20.5 dBm @ 900/1900/2140 MHz
- 5V/75mA, MTTF > 100 Years, MSL 1, Class 1B
- Lead-free/RoHS-compliant SOT-89 SMT package



Product Description

BeRex's BL011 is a high performance LNA based on GaAs material with E-pHEMT process, packaged in a RoHS-compliant with SOT-89 surface mount package. It is designed for use where low noise and high linearity are required and features low noise and high OIP3 at wideband frequency. It requires a few external matching components. All devices are 100% RF/DC tested and classified as HBM ESDS **Class 1B**.

Typical Performance¹

Parameter	Frequency					Unit
	900	1900	2140	2450	3500	
Gain	22.0	17.0	16.5	15.5	13.0	dB
S11	-19.0	-24.0	-24.0	-19.5	-18.0	dB
S22	-15.0	-15.5	-21.5	-15.5	-15.0	dB
OIP3 ²	33.5	36.0	35.5	38.0	36.0	dBm
P1dB	20.5	20.5	20.5	20.0	18.0	dBm
Noise Figure	0.91	1.13	1.17	1.30	1.56	dB

¹ Device performance _ measured on a BeRex evaluation board at 25°C, 50 Ω system.

² OIP3 _ measured with two tones at an output of 5 dBm per tone separated by 1 MHz.

Applications

- Base station Infrastructure/RFID
- Commercial/Industrial/Military wireless system

	Min.	Typical	Max.	Unit
Bandwidth	5		4000	MHz
I _c @ (V _c = 5V)	65	75	90	mA
V _c		5.0		V
R _{TH}		43		°C/W

Applications Circuit

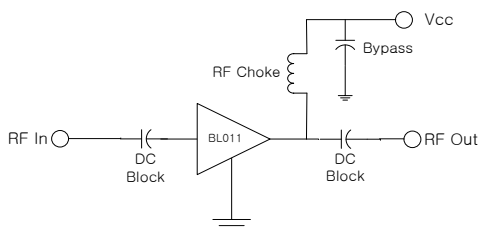

*external matching circuit: refer to the page 5 to 13.

Absolute Maximum Ratings

Parameter	Rating	Unit
Operating Case Temperature	-40 to +85	°C
Storage Temperature	-55 to +155	°C
Junction Temperature	+220	°C
Operating Voltage	+6.0	V
Supply Current	200	mA
Input RF Power	30	dBm

Operation of this device above any of these parameters may result in permanent damage.

BL011

5-4000 MHz Wideband Low Noise Amplifier



V-I Characteristics

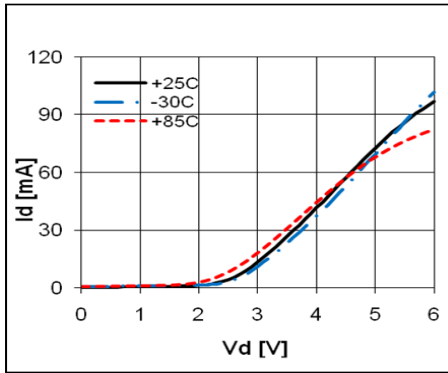

BeRex SOT89 Evaluation Board

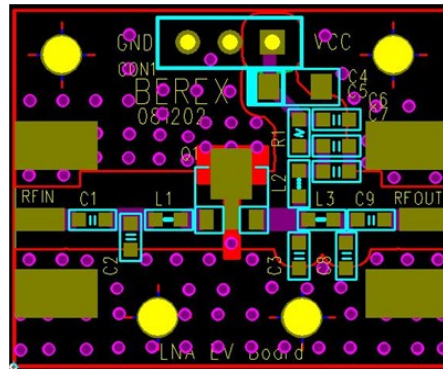

*Dielectric constant _ 4.2 *RF pattern width 52mil *31mil thick FR4 PCB

Typical Device Data

S-parameters (Vd=5V, Id=75mA, T=25°C)

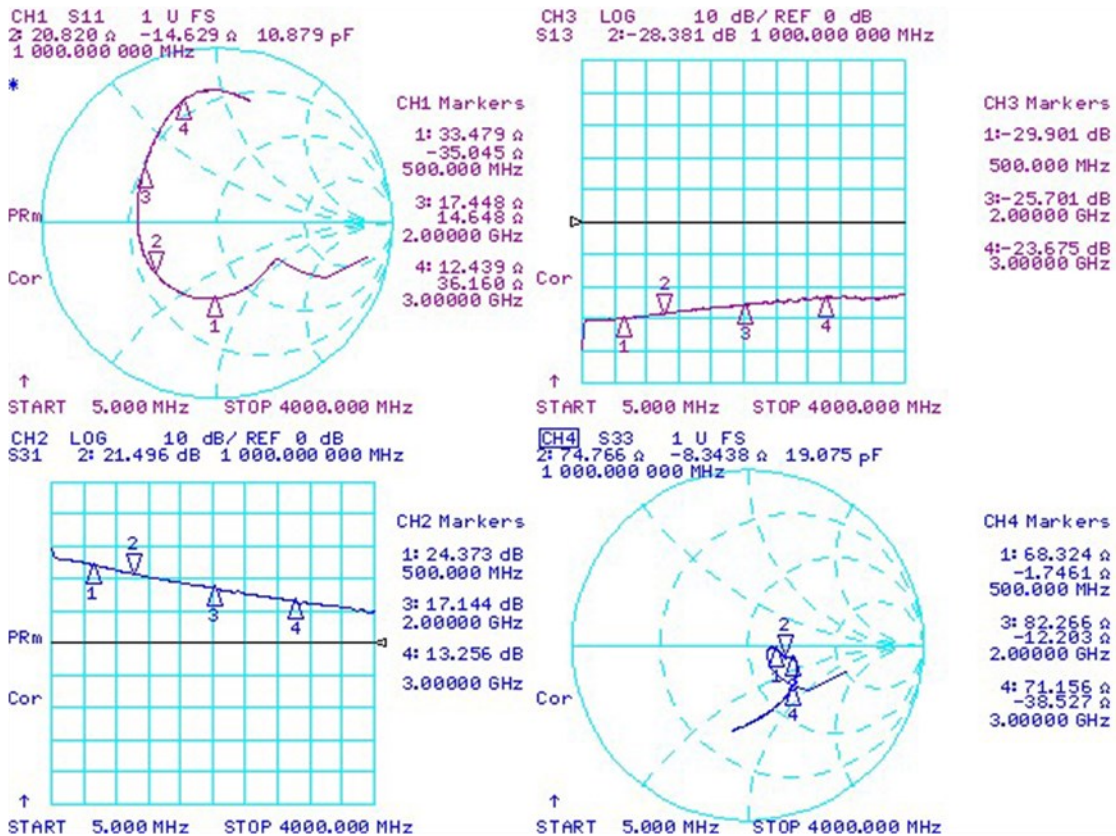



S-Parameter

(V_{device} = 5.0V, I_{cc} = 75mA, T = 25 °C, calibrated to device leads)

Freq [MHz]	S11 [Mag]	S11 [Ang]	S21 [Mag]	S21 [Ang]	S12 [Mag]	S12 [Ang]	S22 [Mag]	S22 [Ang]
100	0.394	-32.668	20.271	164.806	0.030	9.568	0.135	-29.347
500	0.431	-92.314	16.433	130.319	0.032	11.743	0.156	-6.174
1000	0.454	-141.505	11.810	98.232	0.039	16.118	0.206	-15.572
1500	0.455	178.736	8.990	73.537	0.046	12.886	0.229	-17.502
2000	0.518	143.413	7.118	54.527	0.051	7.508	0.255	-15.050
2500	0.631	120.153	5.709	34.979	0.056	0.061	0.303	-21.818
3000	0.723	105.634	4.566	19.308	0.066	-7.947	0.346	-42.248
3500	0.761	92.601	3.693	6.841	0.063	-20.854	0.403	-70.796
4000	0.772	74.726	3.014	-9.896	0.073	-31.161	0.499	-100.140

V_d = 5V, I_d = 75.0mA, T_a = 25°C

Freq	MHz	900	1900	2140	2450
S21	dB	22.0	17.0	17.0	15.5
S11	dB	-19.0	-24.0	-24.0	-19.5
S22	dB	-15.0	-15.5	-21.5	-16.0
P1	dBm	20.5	20.5	20.5	20.0
OIP3	dBm	33.5	36.0	35.5	38.0
NF	dB	0.91	1.13	1.17	1.30

V_d = 4.8V, I_d = 70.0mA, T_a = 25°C

Freq	MHz	900	1900	2140	2450
S21	dB	21.8	17.0	16.9	15.5
S11	dB	-18.8	-24.5	-23.2	-19.5
S22	dB	-15.3	-16.5	-23.1	-16.9
P1	dBm	20.3	20.2	20.2	19.7
OIP3	dBm	33.4	35.5	36.0	37.0
NF	dB	0.91	1.13	1.17	1.30

V_d = 4.6V, I_d = 65.0mA, T_a = 25°C

Freq	MHz	900	1900	2140	2450
S21	dB	21.8	17.0	16.8	15.5
S11	dB	-18.3	-24.7	-22.6	-19.6
S22	dB	-15.6	-17.4	-24.8	-18.1
P1	dBm	19.9	19.8	19.8	19.3
OIP3	dBm	32.9	35.0	36.0	36.0
NF	dB	0.91	1.13	1.17	1.30

V_d = 4.4V, I_d = 59.0mA, T_a = 25°C

Freq	MHz	900	1900	2140	2450
S21	dB	21.7	17.0	16.7	15.5
S11	dB	-17.5	-24.9	-21.8	-19.5
S22	dB	-15.8	-18.4	-26.6	-19.3
P1	dBm	19.4	19.4	19.6	18.9
OIP3	dBm	32.4	34.5	36.0	35.0
NF	dB	0.91	1.13	1.17	1.30

BL011

5-4000 MHz Wideband Low Noise Amplifier



Vd = 4.2V, Id = 53.0mA, Ta = 25°C

Freq	MHz	900	1900	2140	2450
S21	dB	21.6	17.0	16.6	15.4
S11	dB	- 16.8	- 24.9	- 21.1	- 19.5
S22	dB	- 15.9	- 19.4	- 27.7	- 21.0
P1	dBm	18.9	19.0	19.2	18.5
OIP3	dBm	31.5	33.5	35.0	34.0
NF	dB	0.91	1.13	1.17	1.30

Vd = 4.0V, Id = 46.0mA, Ta = 25°C

Freq	MHz	900	1900	2140	2450
S21	dB	21.5	17.0	16.5	15.3
S11	dB	- 15.9	- 24.9	- 20.4	- 19.4
S22	dB	- 15.8	- 20.5	- 27.6	- 22.8
P1	dBm	18.3	18.6	18.7	18.0
OIP3	dBm	30.5	33.0	34.0	33.0
NF	dB	0.91	1.13	1.17	1.30

Vd = 3.5V, Id = 34.0mA, Ta = 25°C

Freq	MHz	900	1900	2140	2450
S21	dB	21.0	16.7	16.1	15.0
S11	dB	- 13.1	- 23.6	- 18.5	- 19.3
S22	dB	- 14.2	- 21.9	- 22.5	- 27.7
P1	dBm	16.1	17.2	17.4	16.6
OIP3	dBm	26.0	29.5	30.5	30.0
NF	dB	0.91	1.13	1.17	1.30

BL011

5-4000 MHz Wideband Low Noise Amplifier



Application Circuit: 900 MHz

Schematic Diagram		BOM	Tolerance	
		C1	10uF	± 20%
		C2	1000pF	±5%
		C3	100pF	± 5%
		C4	28pF	± 5%
		C5	2.7pF	± 5%
		C6	150pF	±5%
		L1	6.8nH	±5%
		L2	39nH	±5%
		R1	13ohm	± 5%

Typical Performance

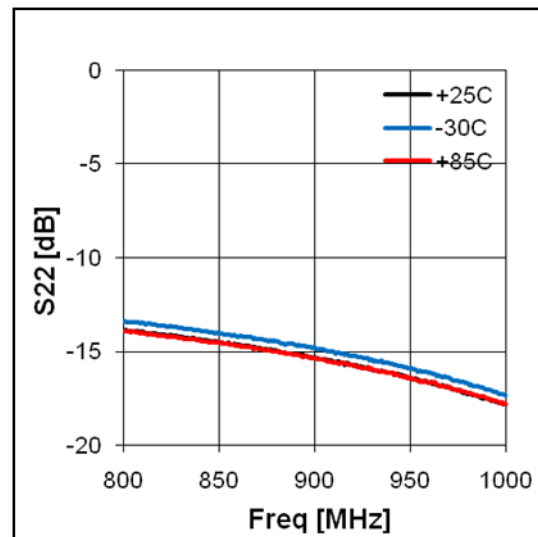
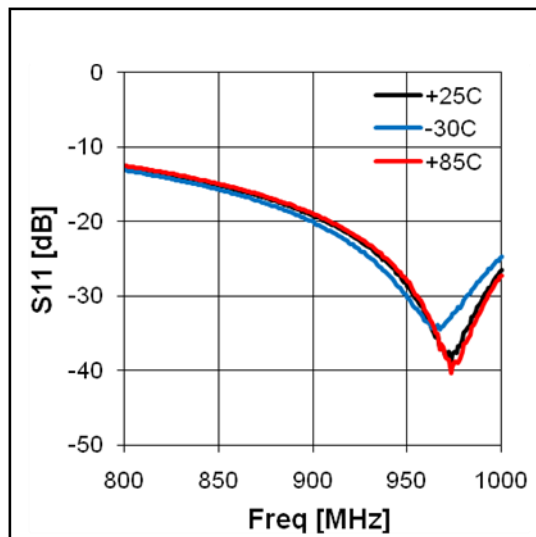

BL011

5-4000 MHz Wideband Low Noise Amplifier

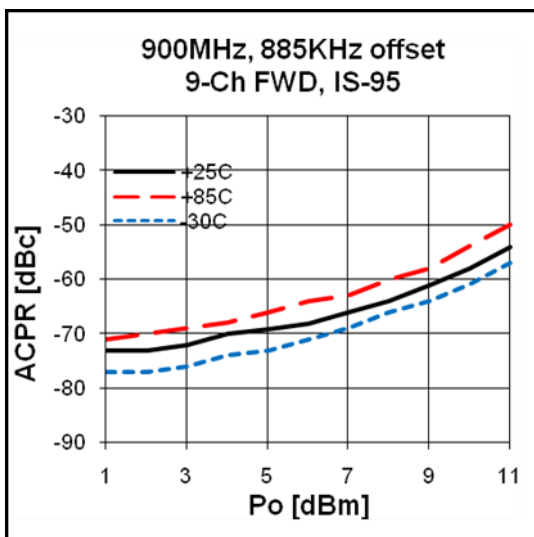
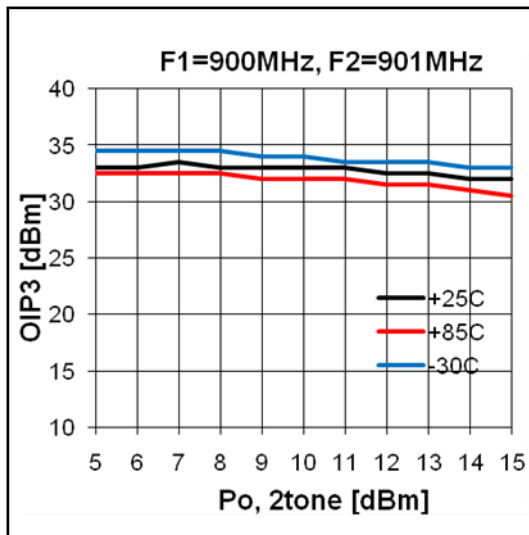
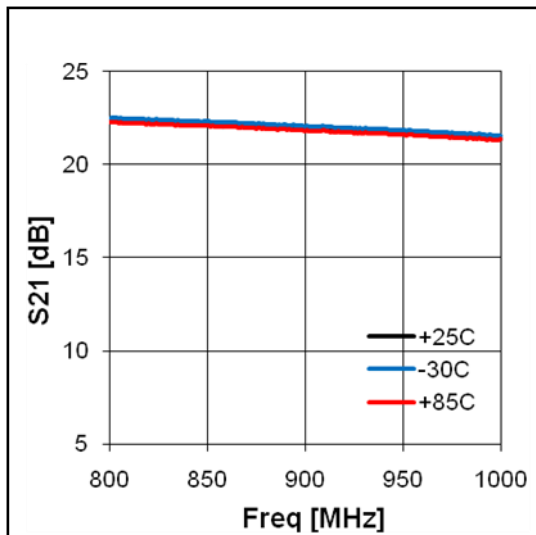

Noise Figure Temperature Performance

(Vd = 5.0V, Id = 75.0mA)

Freq	MHz	900	1900	2140	2450
Temp [°C]	-30	0.84	1.07	1.11	1.25
	25	0.91	1.13	1.17	1.30
	85	1.13	1.33	1.38	1.56

BL011

5-4000 MHz Wideband Low Noise Amplifier



Application Circuit: 1900 MHz

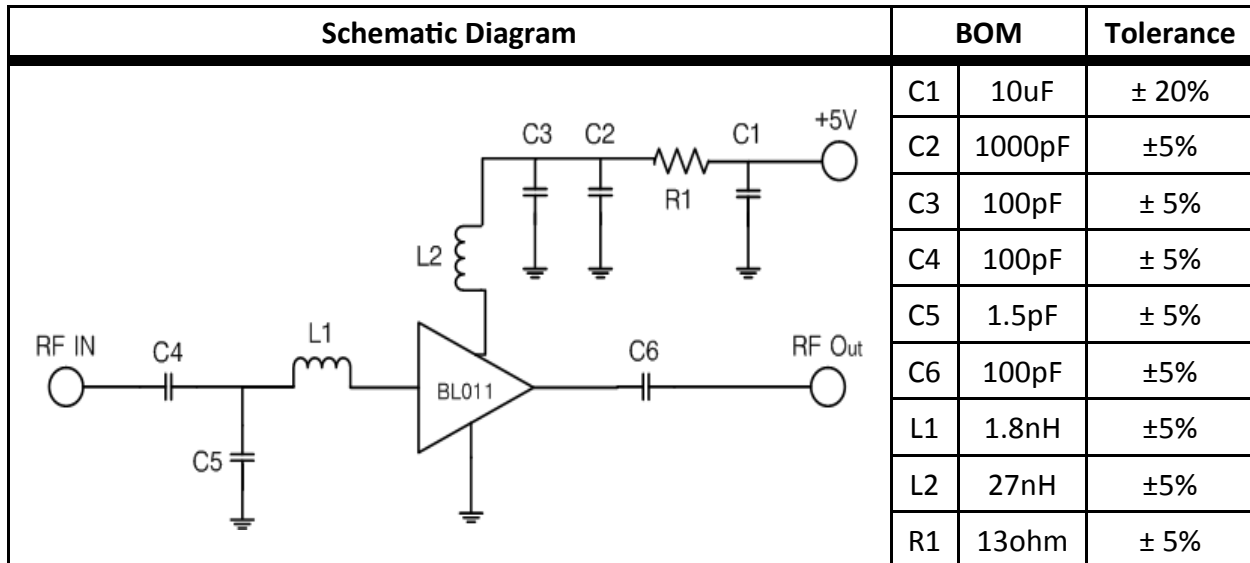

Typical Performance

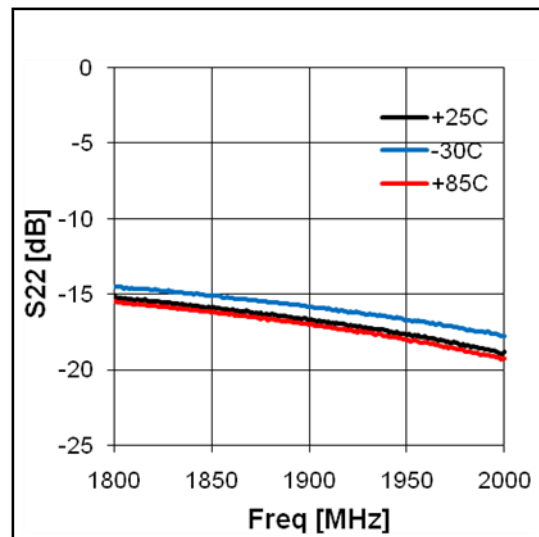
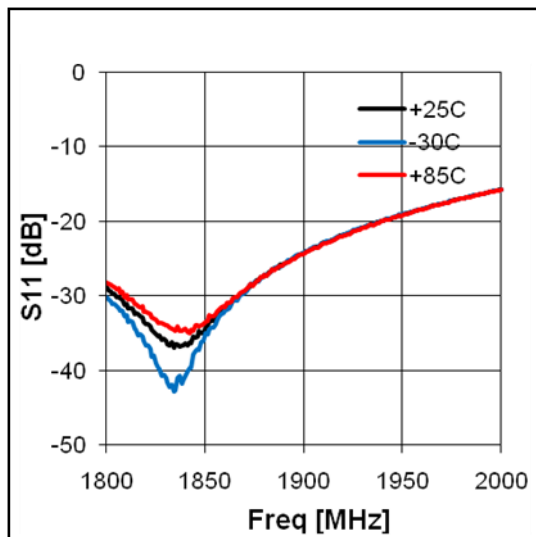

BL011

5-4000 MHz Wideband Low Noise Amplifier

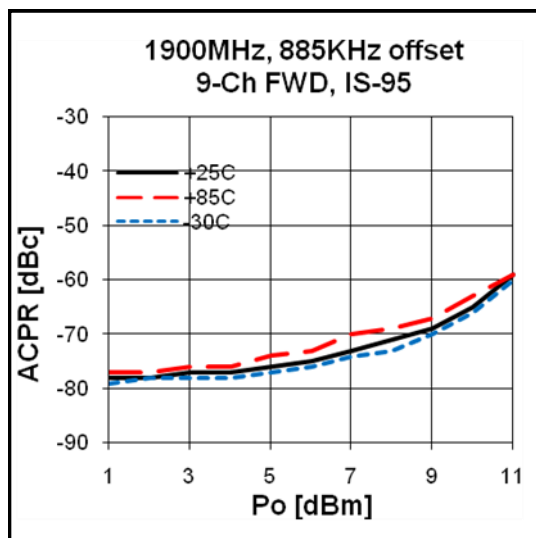
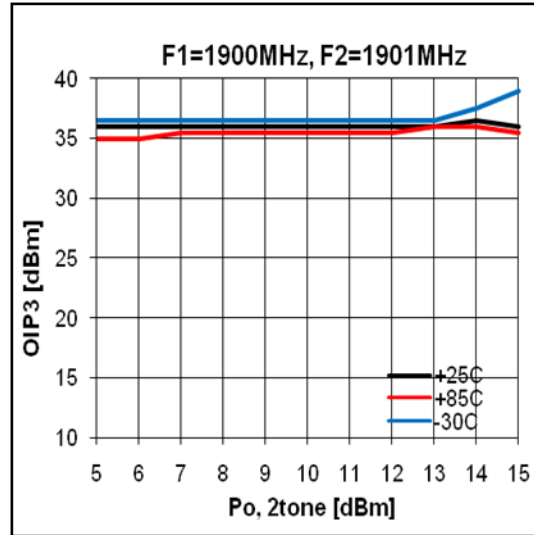
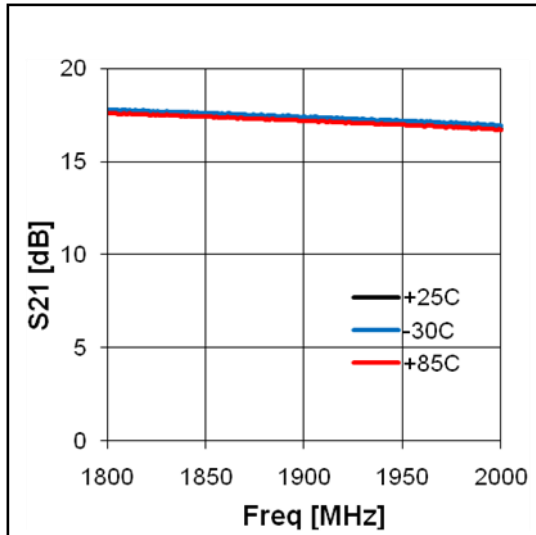

Noise Figure Temperature Performance

(Vd = 5.0V, Id = 75.0mA)

Freq	MHz	900	1900	2140	2450
Temp [°C]	-30	0.84	1.07	1.11	1.25
	25	0.91	1.13	1.17	1.30
	85	1.13	1.33	1.38	1.56

BL011

5-4000 MHz Wideband Low Noise Amplifier



Application Circuit: 2140 MHz

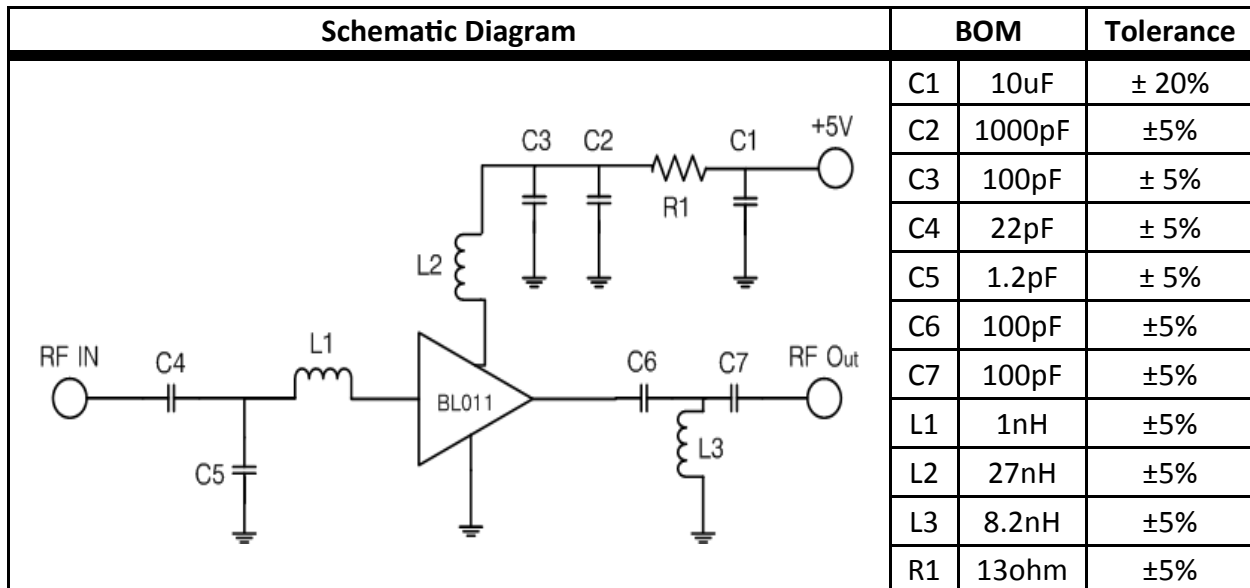

Typical Performance

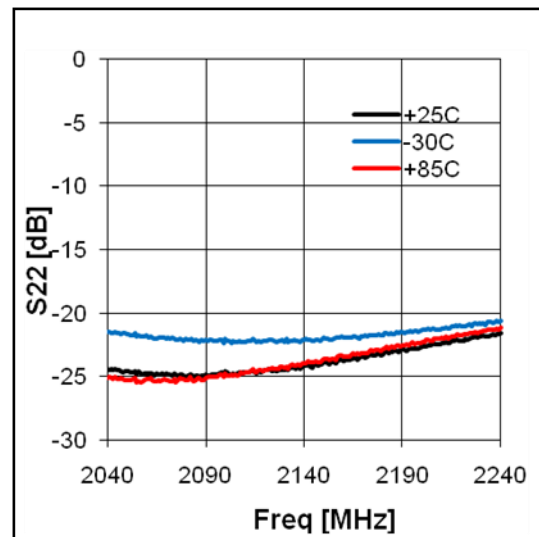
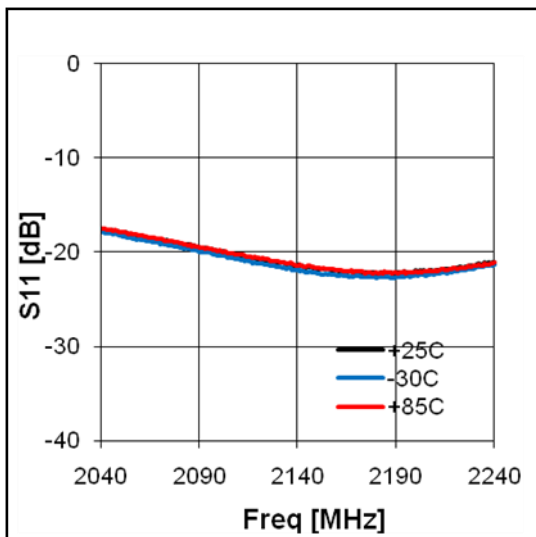

BL011

5-4000 MHz Wideband Low Noise Amplifier

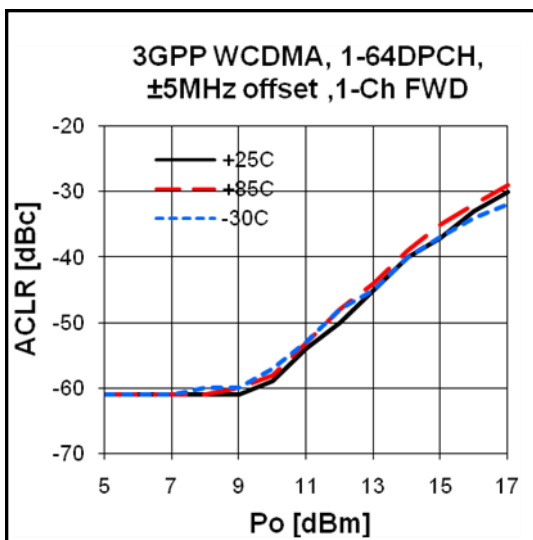
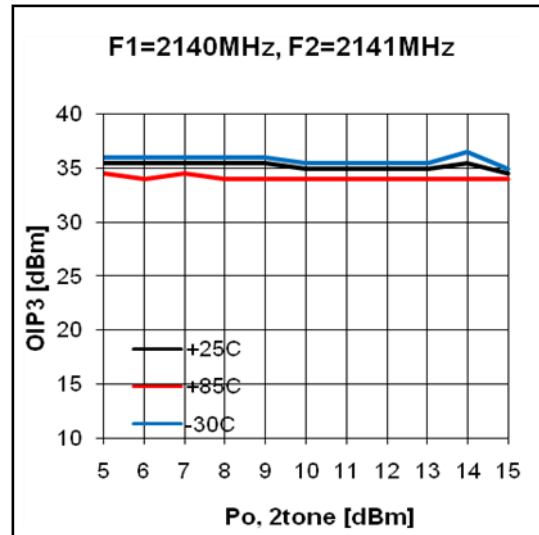
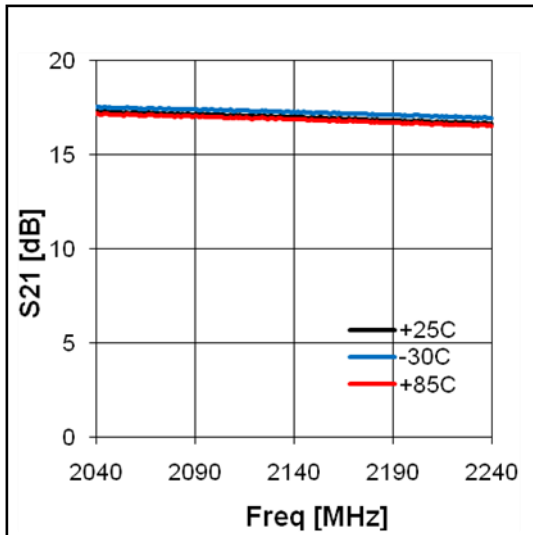

Noise Figure Temperature Performance

(Vd = 5.0V, Id = 75.0mA)

Freq	MHz	900	1900	2140	2450
Temp	-30	0.84	1.07	1.11	1.25
	25	0.91	1.13	1.17	1.30
	85	1.13	1.33	1.38	1.56

BL011

5-4000 MHz Wideband Low Noise Amplifier



Application Circuit: 2450 MHz

Schematic Diagram		BOM	Tolerance	
		C1	10uF	± 20%
		C2	1000pF	±5%
		C3	100pF	± 5%
		C4	39pF	± 5%
		C5	1.2pF	± 5%
		C6	100pF	±5%
		L1	22nH	±5%
		R1	13 ohm	±5%

Typical Performance

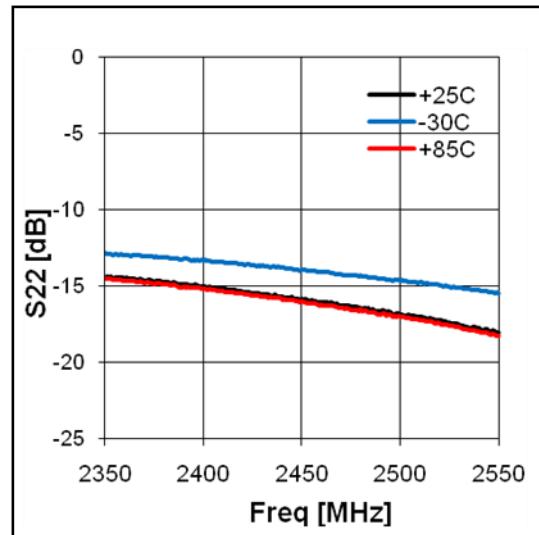
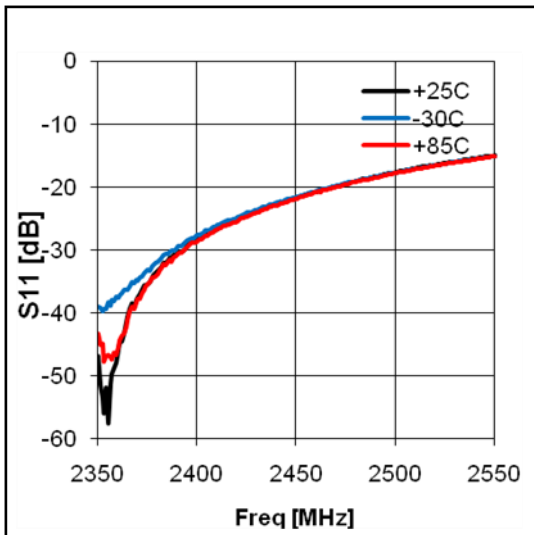

BL011

5-4000 MHz Wideband Low Noise Amplifier

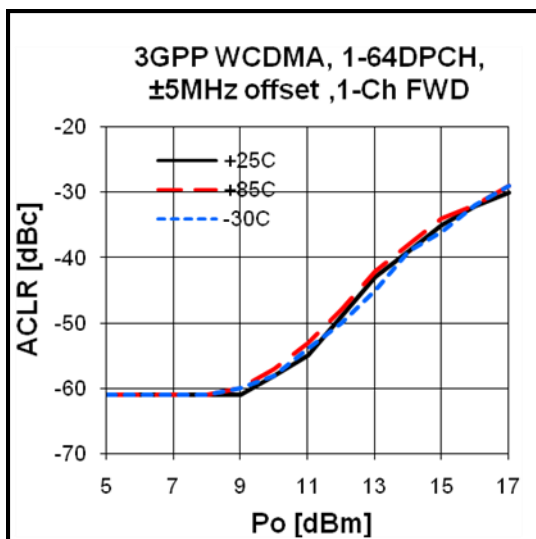
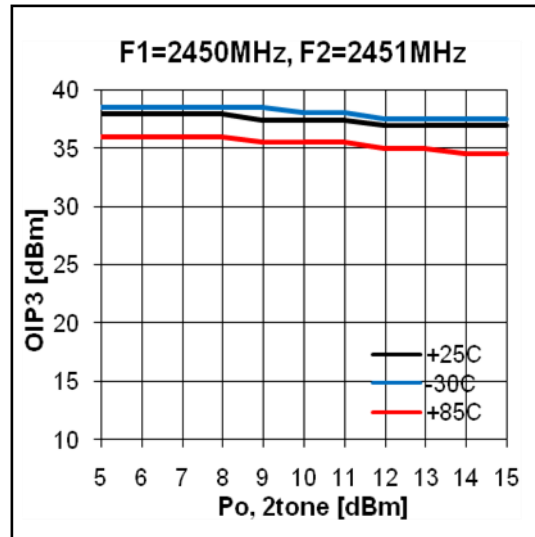
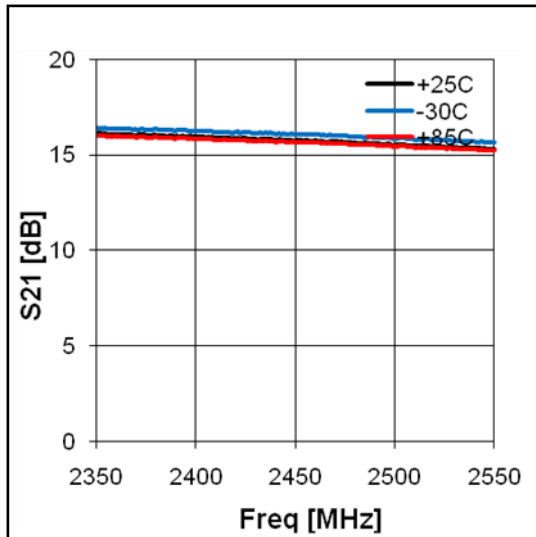

Noise Figure Temperature Performance

(Vd = 5.0V, Id = 75.0mA)

Freq	MHz	900	1900	2140	2450
Temp	-30	0.84	1.07	1.11	1.25
	25	0.91	1.13	1.17	1.30
	85	1.13	1.33	1.38	1.56

BL011

5-4000 MHz Wideband Low Noise Amplifier



Application Circuit: 3500 MHz

Schematic Diagram		BOM	Tolerance	
		C1	10uF	± 20%
		C2	1000pF	±5%
		C3	100pF	± 5%
		C4	100pF	± 5%
		C5	0.5pF	± 5%
		C6	1.2pF	±5%
		C7	100pF	±5%
		L1	8.2nH	±5%
		R1	13 ohm	±5%

Typical Performance

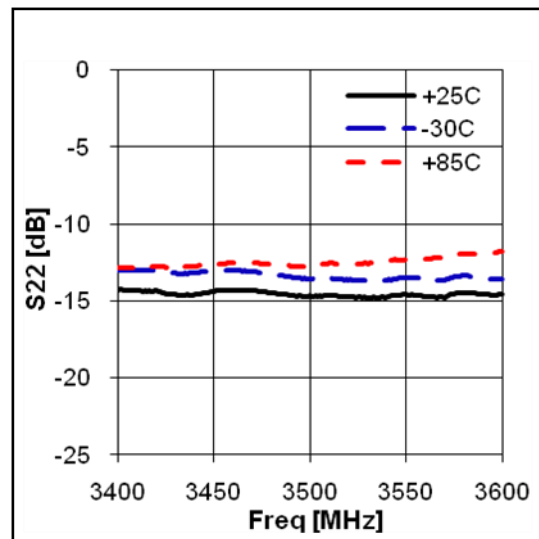
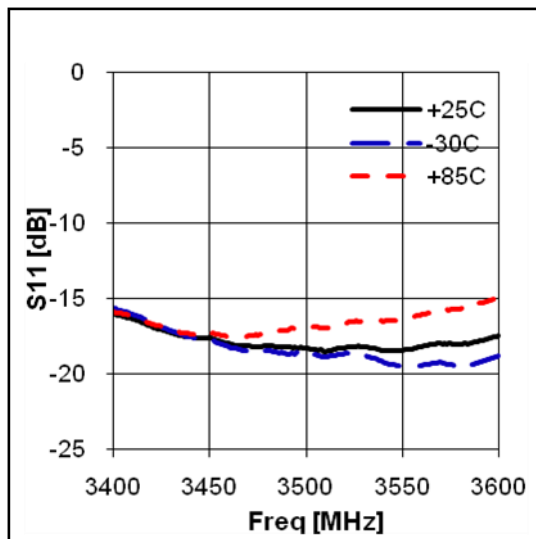

BL011

5-4000 MHz Wideband Low Noise Amplifier

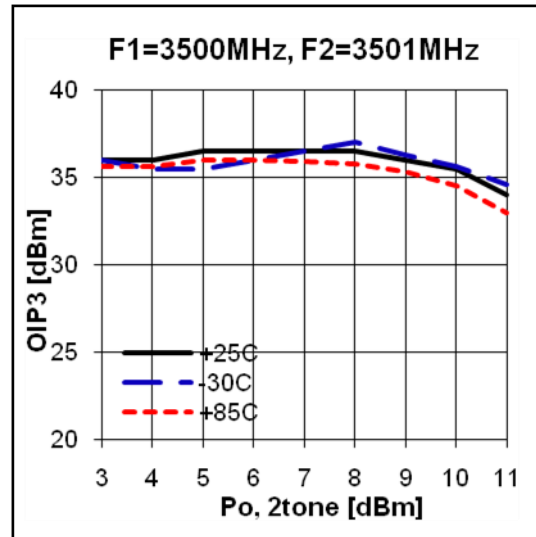
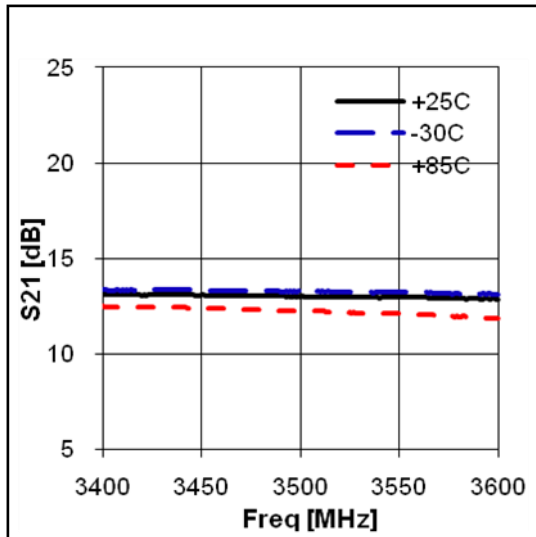

Noise Figure Temperature Performance

(Vd = 5.0V, Id = 75.0mA)

Freq	MHz	900	1900	2140	2450	3500
Temp [°C]	-30	0.84	1.07	1.11	1.25	1.32
	25	0.91	1.13	1.17	1.30	1.56
	85	1.13	1.33	1.38	1.56	1.71

BL011

5-4000 MHz Wideband Low Noise Amplifier



Package Outline Dimension

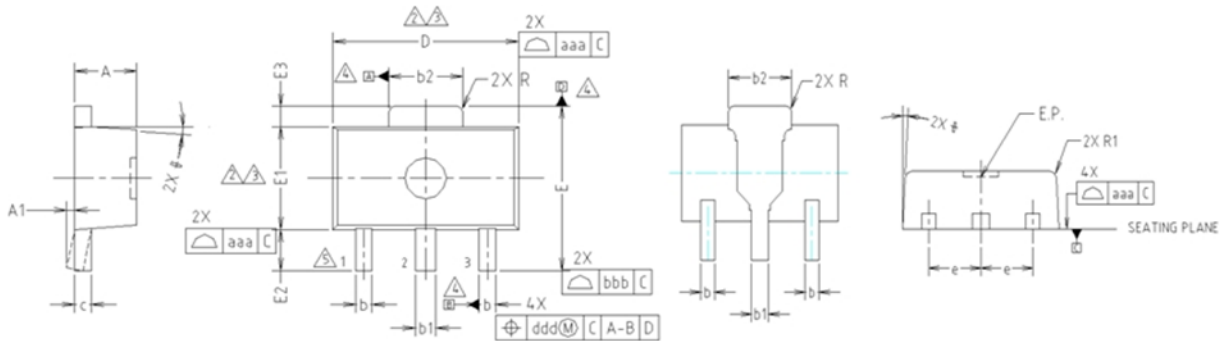

- NOTE:**
1. DIMENSIONS IN MILLIMETERS.
- ⚠ DIMENSION D DOES NOT INCLUDE MOLD FLASH, PROTRUSIONS OR GATE BURRS. MOLD FLASH, PROTRUSIONS OR GATE BURRS SHALL NOT EXCEED 0.5mm PER END. DIMENSION E1 DOES NOT INCLUDE INTERLEAD FLASH OR PROTRUSION. INTERLEAD FLASH OR PROTRUSION SHALL NOT EXCEED 0.5mm PER SIDE.
 - ⚠ DIMENSIONS D AND E1 ARE DETERMINED AT THE OUTMOST EXTREMES OF THE PLASTIC BODY EXCLUSIVE OF MOLD FLASH, TIE BAR BURRS, GATE BURRS AND INTERLEAD FLASH, BUT INCLUDING ANY MISMATCH BETWEEN THE TOP AND BOTTOM OF THE PLASTIC BODY.
 - ⚠ DATUMS A, B AND D TO BE DETERMINED 0.18mm FROM THE LEAD TIP.
 - ⚠ TERMINAL NUMBERS ARE SHOWN FOR REFERENCE ONLY.

SYMBOL	MILLIMETERS			NOTE
	MINIMUM	NOMINAL	MAXIMUM	
A	1.40	1.50	1.60	
A1	0.00	—	0.10	
b	0.38	0.42	0.48	
b1	0.48	0.52	0.58	
b2	1.79	1.82	1.87	
c	0.40	0.42	0.46	
D	4.40	4.50	4.70	2,3
E	3.70	4.00	4.30	
E1	2.40	2.50	2.70	2,3
E2	0.80	1.00	1.20	
E3	0.40	0.50	0.60	
e	1.50 TYP.			
φ	4° TYP.			
R	0.15 TYP.			
R1	—	—	0.20	
SYMBOL	TOLERANCES OF FORM AND POSITION		NOTE	
aaa	0.15			
bbb	0.20			
ccc	0.10			
ddd	0.10			

Suggested PCB Land Pattern and PAD Layout

PCB Land Pattern

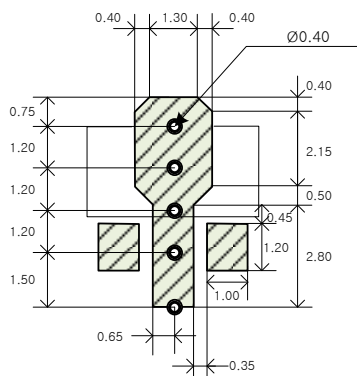

Note : All dimension _ millimeters

PCB lay out _ on BeRex website

PCB Mounting

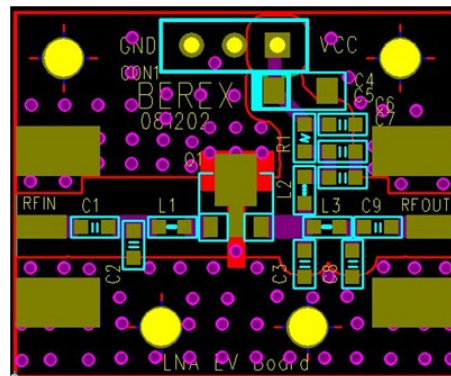

BL011

5-4000 MHz Wideband Low Noise Amplifier



Package Marking

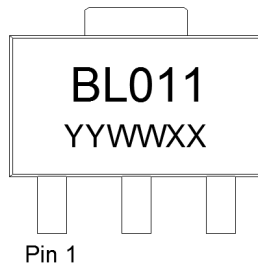

YY = Year, WW = Working Week,
XX = Wafer No.

Tape & Reel

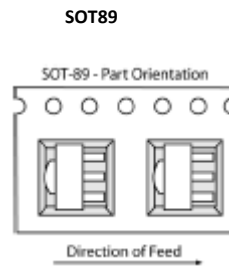

Packaging information:

Tape Width (mm): 12
Reel Size (inches): 7
Device Cavity Pitch (mm): 8
Devices Per Reel: 1000

Lead plating finish

100% Tin Matte finish

(All BeRex products undergoes a 1 hour, 150 degree C, Anneal bake to eliminate thin whisker growth concerns.)

MSL / ESD Rating

ESD Rating:	Class 1B
Value:	Passes <1000V
Test:	Human Body Model (HBM)
Standard:	JEDEC Standard JESD22-A114B
MSL Rating:	Level 1 at +265°C convection reflow
Standard:	JEDEC Standard J-STD-020

NATO CAGE code:

2	N	9	6	F
---	---	---	---	---