

To our customers,

Old Company Name in Catalogs and Other Documents

On April 1st, 2010, NEC Electronics Corporation merged with Renesas Technology Corporation, and Renesas Electronics Corporation took over all the business of both companies. Therefore, although the old company name remains in this document, it is a valid Renesas Electronics document. We appreciate your understanding.

Renesas Electronics website: <http://www.renesas.com>

April 1st, 2010
Renesas Electronics Corporation

Issued by: Renesas Electronics Corporation (<http://www.renesas.com>)

Send any inquiries to <http://www.renesas.com/inquiry>.

Notice

1. All information included in this document is current as of the date this document is issued. Such information, however, is subject to change without any prior notice. Before purchasing or using any Renesas Electronics products listed herein, please confirm the latest product information with a Renesas Electronics sales office. Also, please pay regular and careful attention to additional and different information to be disclosed by Renesas Electronics such as that disclosed through our website.
2. Renesas Electronics does not assume any liability for infringement of patents, copyrights, or other intellectual property rights of third parties by or arising from the use of Renesas Electronics products or technical information described in this document. No license, express, implied or otherwise, is granted hereby under any patents, copyrights or other intellectual property rights of Renesas Electronics or others.
3. You should not alter, modify, copy, or otherwise misappropriate any Renesas Electronics product, whether in whole or in part.
4. Descriptions of circuits, software and other related information in this document are provided only to illustrate the operation of semiconductor products and application examples. You are fully responsible for the incorporation of these circuits, software, and information in the design of your equipment. Renesas Electronics assumes no responsibility for any losses incurred by you or third parties arising from the use of these circuits, software, or information.
5. When exporting the products or technology described in this document, you should comply with the applicable export control laws and regulations and follow the procedures required by such laws and regulations. You should not use Renesas Electronics products or the technology described in this document for any purpose relating to military applications or use by the military, including but not limited to the development of weapons of mass destruction. Renesas Electronics products and technology may not be used for or incorporated into any products or systems whose manufacture, use, or sale is prohibited under any applicable domestic or foreign laws or regulations.
6. Renesas Electronics has used reasonable care in preparing the information included in this document, but Renesas Electronics does not warrant that such information is error free. Renesas Electronics assumes no liability whatsoever for any damages incurred by you resulting from errors in or omissions from the information included herein.
7. Renesas Electronics products are classified according to the following three quality grades: “Standard”, “High Quality”, and “Specific”. The recommended applications for each Renesas Electronics product depends on the product’s quality grade, as indicated below. You must check the quality grade of each Renesas Electronics product before using it in a particular application. You may not use any Renesas Electronics product for any application categorized as “Specific” without the prior written consent of Renesas Electronics. Further, you may not use any Renesas Electronics product for any application for which it is not intended without the prior written consent of Renesas Electronics. Renesas Electronics shall not be in any way liable for any damages or losses incurred by you or third parties arising from the use of any Renesas Electronics product for an application categorized as “Specific” or for which the product is not intended where you have failed to obtain the prior written consent of Renesas Electronics. The quality grade of each Renesas Electronics product is “Standard” unless otherwise expressly specified in a Renesas Electronics data sheets or data books, etc.
 - “Standard”: Computers; office equipment; communications equipment; test and measurement equipment; audio and visual equipment; home electronic appliances; machine tools; personal electronic equipment; and industrial robots.
 - “High Quality”: Transportation equipment (automobiles, trains, ships, etc.); traffic control systems; anti-disaster systems; anti-crime systems; safety equipment; and medical equipment not specifically designed for life support.
 - “Specific”: Aircraft; aerospace equipment; submersible repeaters; nuclear reactor control systems; medical equipment or systems for life support (e.g. artificial life support devices or systems), surgical implantations, or healthcare intervention (e.g. excision, etc.), and any other applications or purposes that pose a direct threat to human life.
8. You should use the Renesas Electronics products described in this document within the range specified by Renesas Electronics, especially with respect to the maximum rating, operating supply voltage range, movement power voltage range, heat radiation characteristics, installation and other product characteristics. Renesas Electronics shall have no liability for malfunctions or damages arising out of the use of Renesas Electronics products beyond such specified ranges.
9. Although Renesas Electronics endeavors to improve the quality and reliability of its products, semiconductor products have specific characteristics such as the occurrence of failure at a certain rate and malfunctions under certain use conditions. Further, Renesas Electronics products are not subject to radiation resistance design. Please be sure to implement safety measures to guard them against the possibility of physical injury, and injury or damage caused by fire in the event of the failure of a Renesas Electronics product, such as safety design for hardware and software including but not limited to redundancy, fire control and malfunction prevention, appropriate treatment for aging degradation or any other appropriate measures. Because the evaluation of microcomputer software alone is very difficult, please evaluate the safety of the final products or system manufactured by you.
10. Please contact a Renesas Electronics sales office for details as to environmental matters such as the environmental compatibility of each Renesas Electronics product. Please use Renesas Electronics products in compliance with all applicable laws and regulations that regulate the inclusion or use of controlled substances, including without limitation, the EU RoHS Directive. Renesas Electronics assumes no liability for damages or losses occurring as a result of your noncompliance with applicable laws and regulations.
11. This document may not be reproduced or duplicated, in any form, in whole or in part, without prior written consent of Renesas Electronics.
12. Please contact a Renesas Electronics sales office if you have any questions regarding the information contained in this document or Renesas Electronics products, or if you have any other inquiries.

(Note 1) “Renesas Electronics” as used in this document means Renesas Electronics Corporation and also includes its majority-owned subsidiaries.

(Note 2) “Renesas Electronics product(s)” means any product developed or manufactured by or for Renesas Electronics.

PIN CONNECTIONS AND INTERNAL BLOCK DIAGRAM

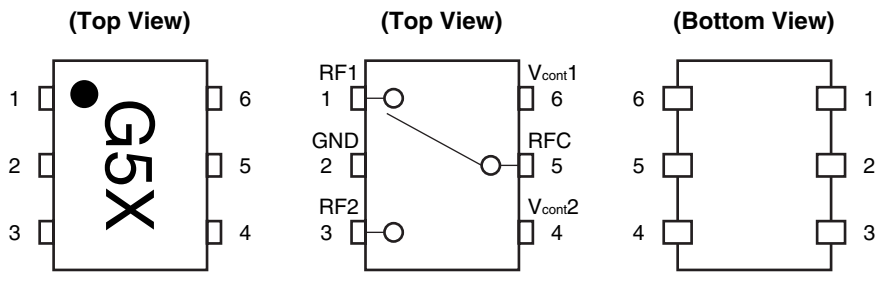

SW TRUTH TABLE

ON Path	V _{cont1}	V _{cont2}
RFC-RF1	Low	High
RFC-RF2	High	Low

ABSOLUTE MAXIMUM RATINGS (T_A = +25°C, unless otherwise specified)

Parameter	Symbol	Ratings	Unit
Switch Control Voltage	V _{cont}	+6.0 ^{Note}	V
Input Power	P _{in}	+33.0	dBm
Operating Ambient Temperature	T _A	-45 to +85	°C
Storage Temperature	T _{stg}	-55 to +150	°C

Note |V_{cont1} - V_{cont2}| ≤ 6.0 V

RECOMMENDED OPERATING RANGE (T_A = +25°C, unless otherwise specified)

Parameter	Symbol	MIN.	TYP.	MAX.	Unit
Operating Frequency	f	0.05	-	3.0	GHz
Switch Control Voltage (H)	V _{cont (H)}	2.5	3.0	5.3	V
Switch Control Voltage (L)	V _{cont (L)}	-0.2	0	0.2	V
Control Voltage Difference	ΔV _{cont (H)} , ΔV _{cont (L)} ^{Note}	-0.1	0	0.1	V

Note ΔV_{cont (H)} = V_{cont1 (H)} - V_{cont2 (H)}

ΔV_{cont (L)} = V_{cont1 (L)} - V_{cont2 (L)}

ELECTRICAL CHARACTERISTICS

(T_A = +25°C, V_{cont} (H) = 3.0 V, V_{cont} (L) = 0 V, DC blocking capacitors = 56 pF, unless otherwise specified)

Parameter	Symbol	Test Conditions	MIN.	TYP.	MAX.	Unit
Insertion Loss 1	L _{ins1}	f = 0.05 to 0.5 GHz ^{Note 1}	–	0.40	0.55	dB
Insertion Loss 2	L _{ins2}	f = 0.5 to 1.0 GHz	–	0.40	0.55	dB
Insertion Loss 3	L _{ins3}	f = 1.0 to 2.0 GHz	–	0.48	0.63	dB
Insertion Loss 4	L _{ins4}	f = 2.0 to 2.5 GHz	–	0.50	0.65	dB
Insertion Loss 5	L _{ins5}	f = 2.5 to 3.0 GHz	–	0.56	0.70	dB
Isolation 1	ISL1	f = 0.05 to 0.5 GHz ^{Note 1}	24	27	–	dB
Isolation 2	ISL2	f = 0.5 to 1.0 GHz	24	27	–	dB
Isolation 3	ISL3	f = 1.0 to 2.0 GHz	16	19	–	dB
Isolation 4	ISL4	f = 2.0 to 2.5 GHz	15	18	–	dB
Isolation 5	ISL5	f = 2.5 to 3.0 GHz	14	17	–	dB
Input Return Loss 1	RL _{in1}	f = 0.05 to 0.5 GHz ^{Note 1}	15	20	–	dB
Input Return Loss 2	RL _{in2}	f = 0.5 to 3.0 GHz	15	20	–	dB
Output Return Loss 1	RL _{out1}	f = 0.05 to 0.5 GHz ^{Note 1}	15	20	–	dB
Output Return Loss 2	RL _{out2}	f = 0.5 to 3.0 GHz	15	20	–	dB
0.1 dB Loss Compression	P _{in (0.1 dB)}	f = 2.0/2.5 GHz	+27.0	+29.0	–	dBm
Input Power ^{Note 2}		f = 0.5 to 3.0 GHz	–	+29.0	–	dBm
Input 3rd Order Intercept Point	IIP ₃	f = 0.5 to 3.0 GHz, 2 tone, 5 MHz spicing	–	+60	–	dBm
Switch Control Current	I _{cont}	No RF input	–	0.3	20	μA
Switch Control Speed	t _{sw}	50% CTL to 90/10% RF	–	50	500	ns

Notes 1. DC blocking capacitors = 1 000 pF at f = 0.05 to 0.5 GHz

2. P_{in (0.1 dB)} is the measured input power level when the insertion loss increases 0.1 dB more than that of linear range.

Caution It is necessary to use DC blocking capacitors with this device.

The value of DC blocking capacitors should be chosen to accommodate the frequency of operation, bandwidth, switching speed and the condition with actual board of your system. The range of recommended DC blocking capacitor value is less than 100 pF for frequencies above 0.5 GHz, and 1 000pF for frequencies above 0.5 GHz.

EVALUATION CIRCUIT

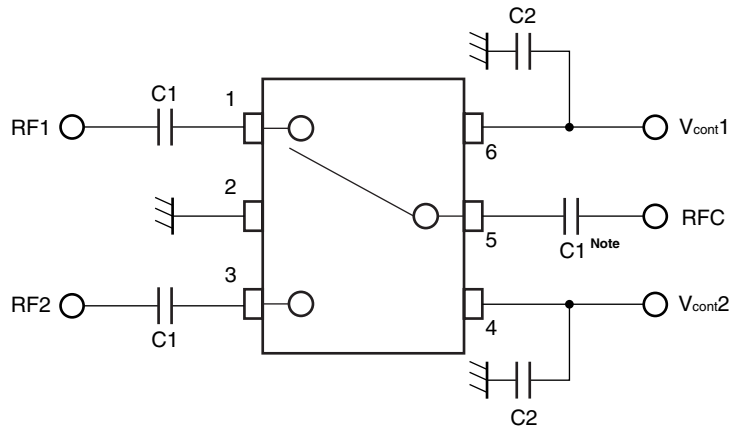

Note C1 : 0.05 to 0.5 GHz 1 000 pF
 : 0.5 to 3.0 GHz 56 pF
 C2 : 1 000 pF

The application circuits and their parameters are for reference only and are not intended for use in actual design-ins.

APPLICATION INFORMATION

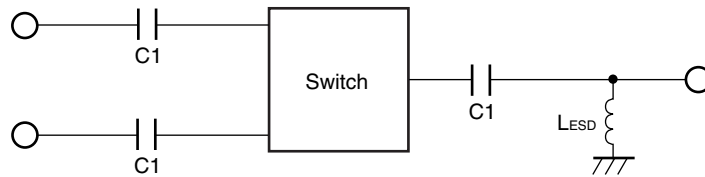

- L_{ESD} provides a means to increase the ESD protection on a specific RF port, typically the port attached to the antenna.
- The value may be tailored to provide specific electrical responses.
- The RF ground connections should be kept as short as possible and connected to directly to a good RF ground for best performance.

ILLUSTRATION OF THE TEST CIRCUIT ASSEMBLED ON EVALUATION BOARD

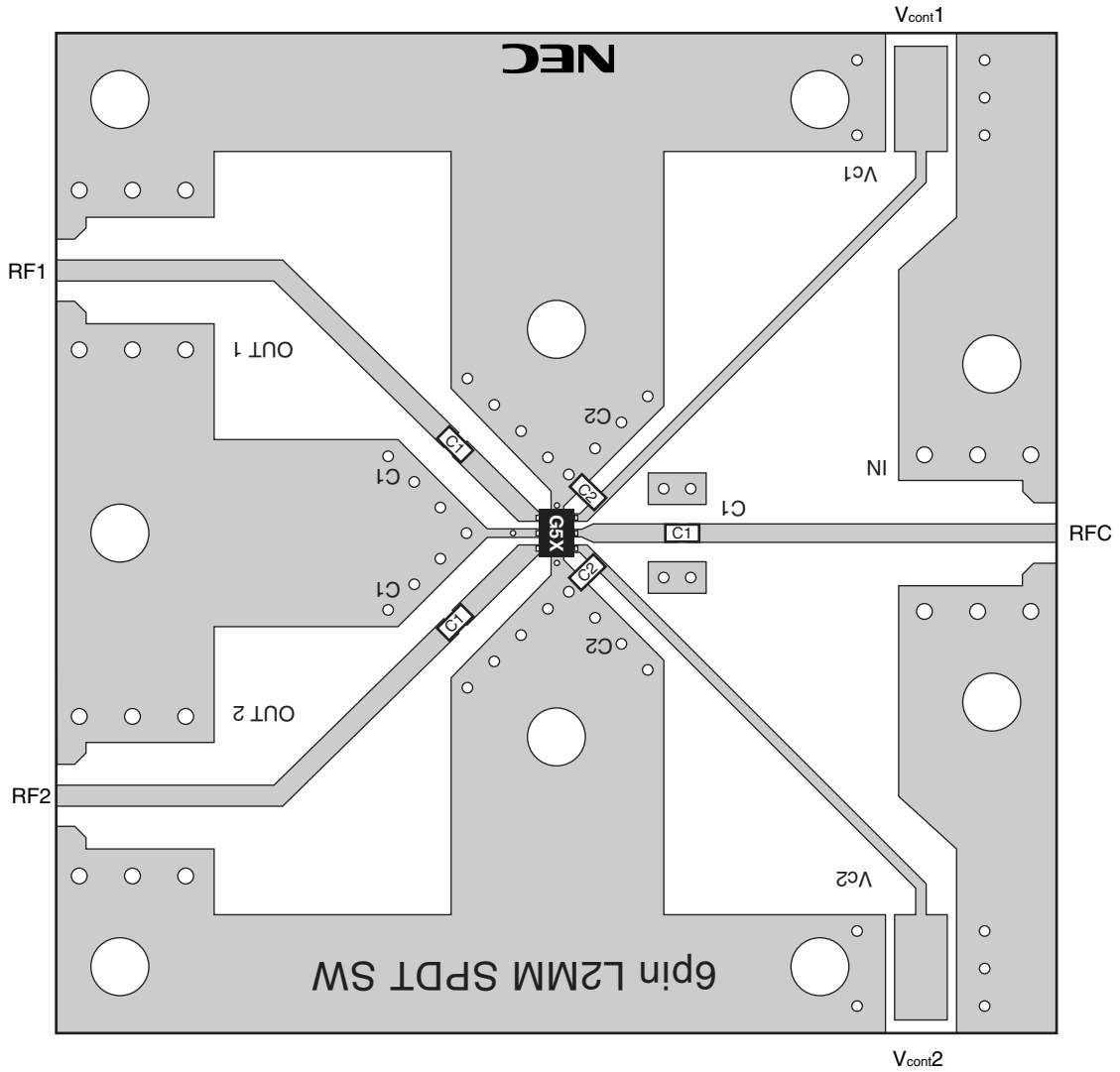

USING THE NEC EVALUATION BOARD

Symbol	Test Conditions	Values
C1	f = 0.05 to 0.5 GHz	1 000 pF
	f = 0.5 to 3.0 GHz	56 pF
C2		1 000 pF

TYPICAL CHARACTERISTICS (TA = +25°C, DC blocking capacitors = 56 pF, unless otherwise specified)

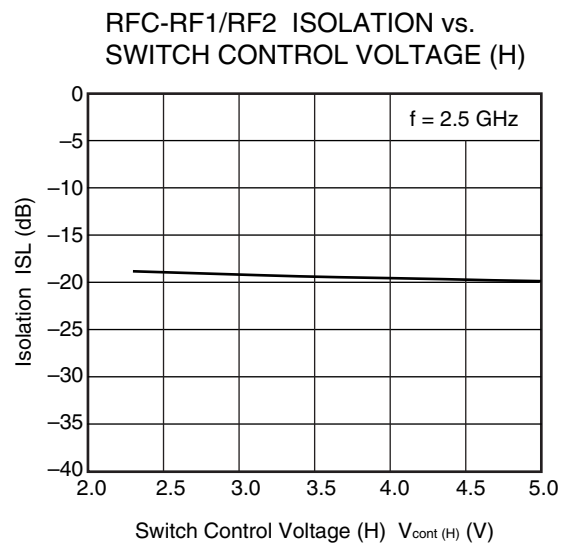
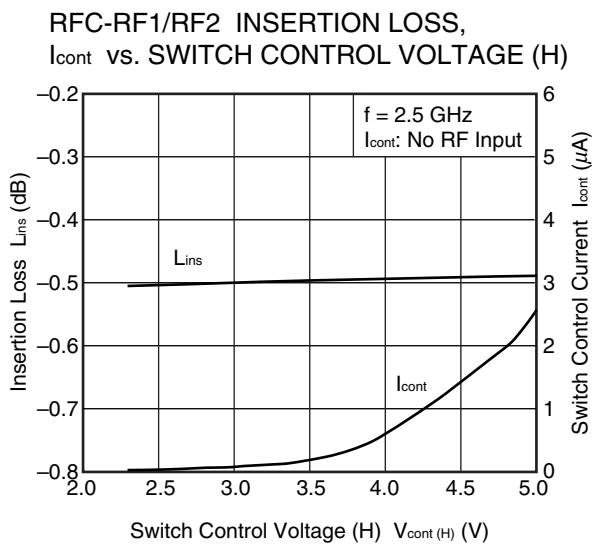
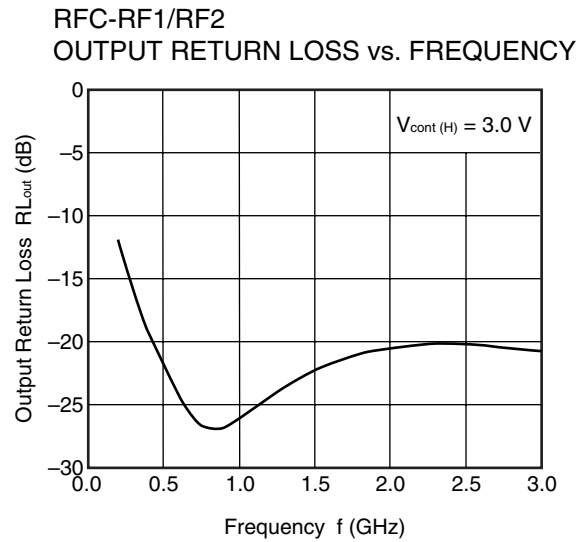
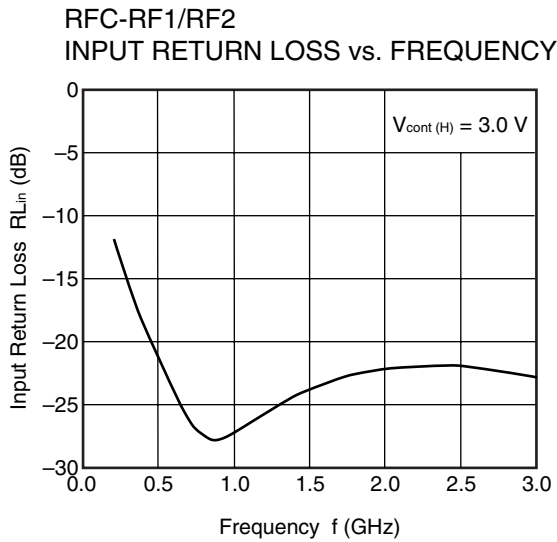
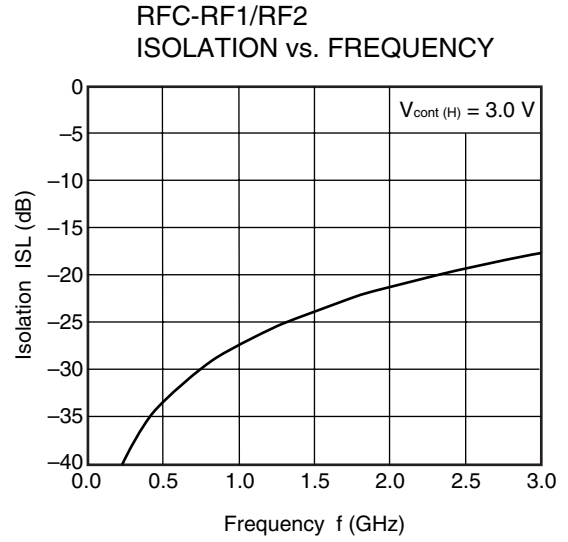
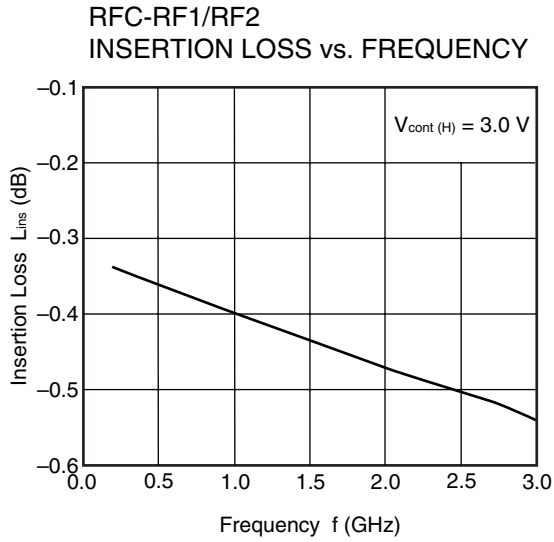

Remark The graphs indicate nominal characteristics.

RFC-RF1/RF2 INPUT RETURN LOSS vs. SWITCH CONTROL VOLTAGE (H)

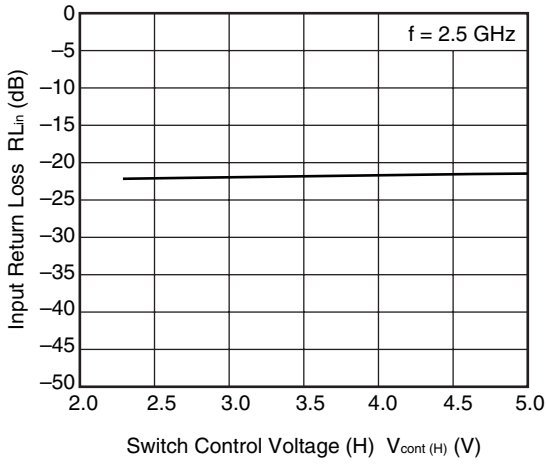

RFC-RF1/RF2 OUTPUT RETURN LOSS vs. SWITCH CONTROL VOLTAGE (H)

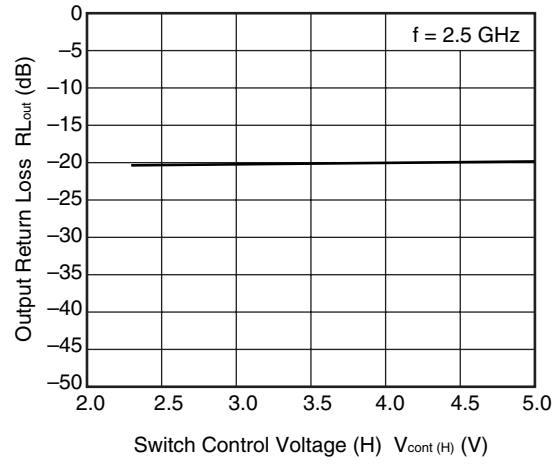

RFC-RF1/RF2 P_{in} (0.1 dB) vs. SWITCH CONTROL VOLTAGE (H)

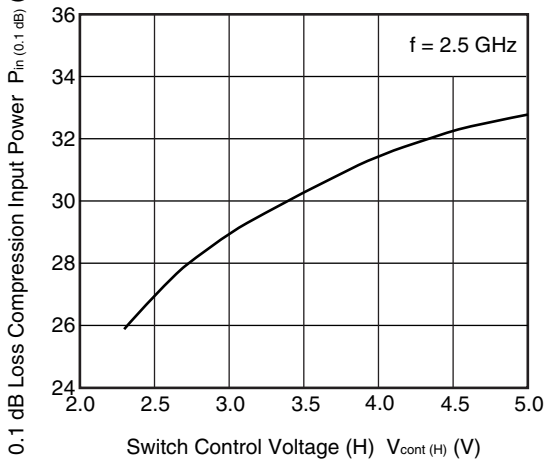

RFC-RF1/RF2 INSERTION LOSS, I_{cont} vs. INPUT POWER

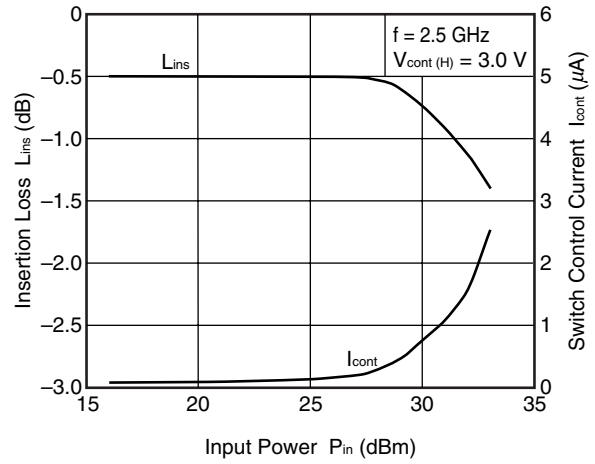

RFC-RF1/RF2 P_{in} (0.1 dB) vs. FREQUENCY

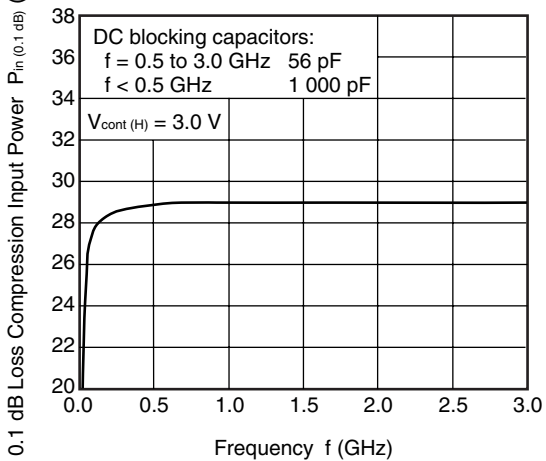

Remark The graphs indicate nominal characteristics.

MOUNTING PAD LAYOUT DIMENSIONS

6-PIN LEAD-LESS MINIMOLD (1511 PKG) (UNIT: mm)

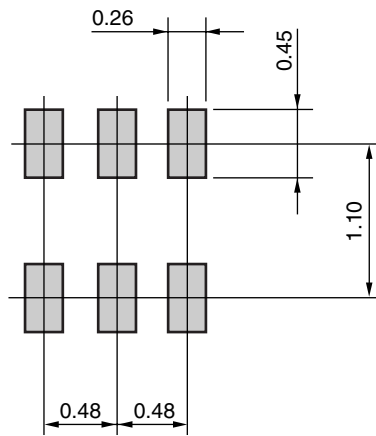

Remark The mounting pad layout in this document is for reference only.
 When designing PCB, please consider workability of mounting, solder joint reliability, prevention of solder bridge and so on, in order to optimize the design.

PACKAGE DIMENSIONS

6-PIN LEAD-LESS MINIMOLD (1511 PKG) (UNIT: mm)

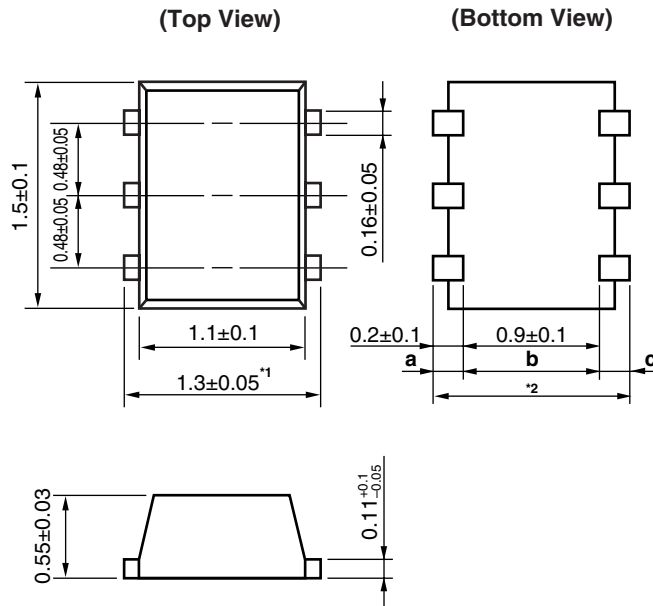

Remark Dimension ¹ is bigger than dimension ² (dimension ² = a + b + c).

RECOMMENDED SOLDERING CONDITIONS

This product should be soldered and mounted under the following recommended conditions. For soldering methods and conditions other than those recommended below, contact your nearby sales office.

Soldering Method	Soldering Conditions	Condition Symbol
Infrared Reflow	Peak temperature (package surface temperature) : 260°C or below Time at peak temperature : 10 seconds or less Time at temperature of 220°C or higher : 60 seconds or less Preheating time at 120 to 180°C : 120±30 seconds Maximum number of reflow processes : 3 times Maximum chlorine content of rosin flux (% mass) : 0.2%(Wt.) or below	IR260
Wave Soldering	Peak temperature (molten solder temperature) : 260°C or below Time at peak temperature : 10 seconds or less Preheating temperature (package surface temperature) : 120°C or below Maximum number of flow processes : 1 time Maximum chlorine content of rosin flux (% mass) : 0.2%(Wt.) or below	WS260
Partial Heating	Peak temperature (terminal temperature) : 350°C or below Soldering time (per side of device) : 3 seconds or less Maximum chlorine content of rosin flux (% mass) : 0.2%(Wt.) or below	HS350

Caution Do not use different soldering methods together (except for partial heating).

Bluetooth is a trademark owned by Bluetooth SIG, Inc., U.S.A.

- **The information in this document is current as of July, 2009. The information is subject to change without notice. For actual design-in, refer to the latest publications of NEC Electronics data sheets, etc., for the most up-to-date specifications of NEC Electronics products. Not all products and/or types are available in every country. Please check with an NEC Electronics sales representative for availability and additional information.**

- No part of this document may be copied or reproduced in any form or by any means without the prior written consent of NEC Electronics. NEC Electronics assumes no responsibility for any errors that may appear in this document.
- NEC Electronics does not assume any liability for infringement of patents, copyrights or other intellectual property rights of third parties by or arising from the use of NEC Electronics products listed in this document or any other liability arising from the use of such products. No license, express, implied or otherwise, is granted under any patents, copyrights or other intellectual property rights of NEC Electronics or others.
- Descriptions of circuits, software and other related information in this document are provided for illustrative purposes in semiconductor product operation and application examples. The incorporation of these circuits, software and information in the design of a customer's equipment shall be done under the full responsibility of the customer. NEC Electronics assumes no responsibility for any losses incurred by customers or third parties arising from the use of these circuits, software and information.
- While NEC Electronics endeavors to enhance the quality and safety of NEC Electronics products, customers agree and acknowledge that the possibility of defects thereof cannot be eliminated entirely. In addition, NEC Electronics products are not taken measures to prevent radioactive rays in the product design. When customers use NEC Electronics products with their products, customers shall, on their own responsibility, incorporate sufficient safety measures such as redundancy, fire-containment and anti-failure features to their products in order to avoid risks of the damages to property (including public or social property) or injury (including death) to persons, as the result of defects of NEC Electronics products.
- NEC Electronics products are classified into the following three quality grades: "Standard", "Special" and "Specific".

The "Specific" quality grade applies only to NEC Electronics products developed based on a customer-designated "quality assurance program" for a specific application. The recommended applications of an NEC Electronics product depend on its quality grade, as indicated below. Customers must check the quality grade of each NEC Electronics product before using it in a particular application.

"Standard": Computers, office equipment, communications equipment, test and measurement equipment, audio and visual equipment, home electronic appliances, machine tools, personal electronic equipment and industrial robots.

"Special": Transportation equipment (automobiles, trains, ships, etc.), traffic control systems, anti-disaster systems, anti-crime systems, safety equipment and medical equipment (not specifically designed for life support).

"Specific": Aircraft, aerospace equipment, submersible repeaters, nuclear reactor control systems, life support systems and medical equipment for life support, etc.

The quality grade of NEC Electronics products is "Standard" unless otherwise expressly specified in NEC Electronics data sheets or data books, etc. If customers wish to use NEC Electronics products in applications not intended by NEC Electronics, they must contact an NEC Electronics sales representative in advance to determine NEC Electronics' willingness to support a given application.

(Note)

- (1) "NEC Electronics" as used in this statement means NEC Electronics Corporation and also includes its majority-owned subsidiaries.
- (2) "NEC Electronics products" means any product developed or manufactured by or for NEC Electronics (as defined above).

M8E0904E

<p>Caution GaAs Products</p>	<p>This product uses gallium arsenide (GaAs). GaAs vapor and powder are hazardous to human health if inhaled or ingested, so please observe the following points.</p> <ul style="list-style-type: none"> • Follow related laws and ordinances when disposing of the product. If there are no applicable laws and/or ordinances, dispose of the product as recommended below. <ol style="list-style-type: none"> 1. Commission a disposal company able to (with a license to) collect, transport and dispose of materials that contain arsenic and other such industrial waste materials. 2. Exclude the product from general industrial waste and household garbage, and ensure that the product is controlled (as industrial waste subject to special control) up until final disposal. • Do not burn, destroy, cut, crush, or chemically dissolve the product. • Do not lick the product or in any way allow it to enter the mouth.
-------------------------------------	---