

**STK520**

.....  
**User Guide**





## Table of Contents

---

### Section 1

Introduction.....	1-2
-------------------	-----

---

### Section 2

Using the STK520 Top Module .....	2-4
2.1 Connecting the STK520 to the STK500 Starter Kit .....	2-4
2.1.1 Placing an AT90PWM3 on the STK520.....	2-4
2.1.2 Placing an AT90PWM2 on the STK520.....	2-5
2.2 Programming the AVR.....	2-7
2.2.1 In-System Programming .....	2-7
2.2.2 High-voltage Programming .....	2-8
2.3 JTAGICE mkII Connector .....	2-9
2.4 STK520 Jumpers, Leds & Test Points.....	2-11
2.5 DALI Interface.....	2-12
2.6 Potentiometer .....	2-13

---

### Section 3

Troubleshooting Guide .....	3-14
-----------------------------	------

---

### Section 4

Technical Specifications.....	4-16
-------------------------------	------

---

### Section 5

Technical Support .....	5-17
-------------------------	------

---

### Section 6

Complete Schematics .....	6-20
---------------------------	------

# Section 1

---

## Introduction

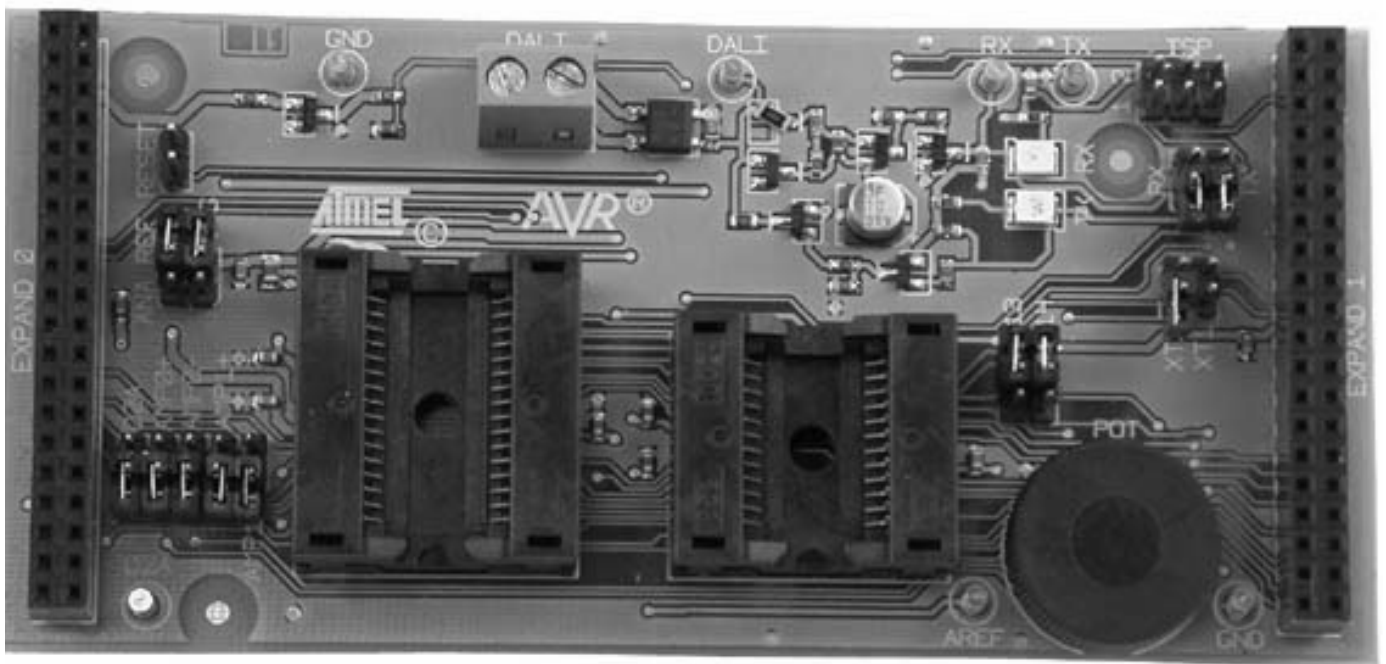
The STK520 board is a top module designed to add AT90PWM family support to the STK500 development board from Atmel Corporation.

The STK520 includes connectors and hardware allowing full utilization of the new features of the AT90PWM, while the Zero Insertion Force (ZIF) socket allows easy use of SO24 & SO32 packages for prototyping.

This user guide acts as a general getting started guide as well as a complete technical reference for advanced users.

Notice that in this guide, the word AVR is used to refer to the target component (AT90PWM2, AT90PWM3...)

**Figure 1-1.** STK520 Top Module for STK500



---

## 1.1 Features

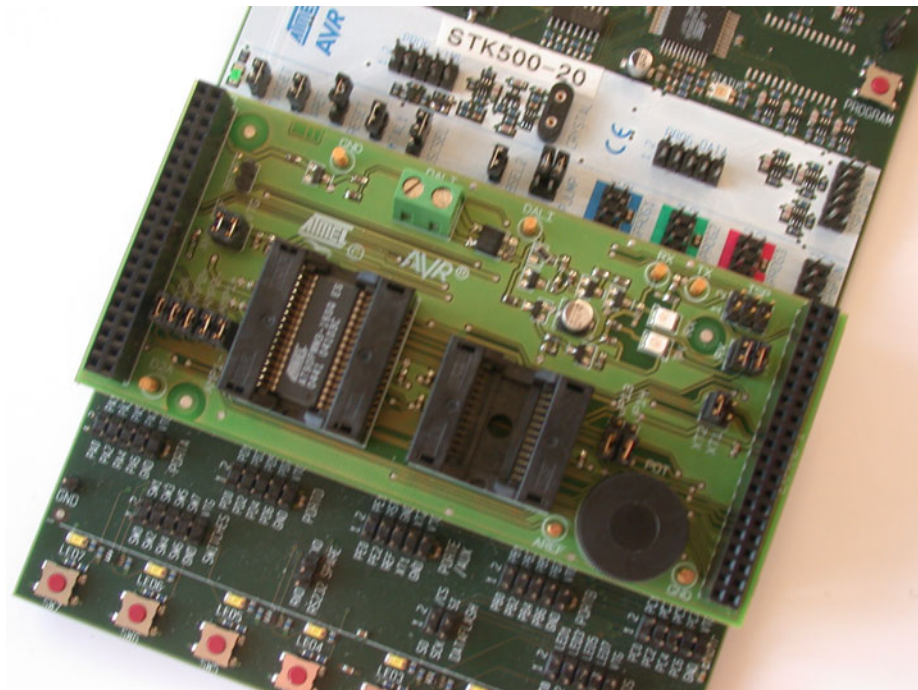
- STK520 is a New Member of the Successful STK500 Starter Kit Family.
- Supports the AT90PWM2 & AT90PWM3.
- DALI Hardware Interface.
- Supported by AVR Studio® 4.
- Zero Insertion Force Socket for SO24 & SO32 Packages.
- High Voltage Parallel Programming.
- Serial Programming.
- DALI Peripherals can be Disconnected from the Device.
- 6 Pin Connector for On-chip Debugging using JTAG MKII Emulator.
- Potentiometer for the Demo Application.
- Quick Reference to all Switches and Jumpers in the Silk-Screen of the PCB.

## Section 2

# Using the STK520 Top Module

- 2.1 Connecting the STK520 to the STK500 Starter Kit** Connect the STK520 to the STK500 expansion header 0 and 1. It is important that the top module is connected in the correct orientation as shown in Figure 2-1. The EXPAND0 written on the STK520 top module should match the EXPAND0 written beside the expansion header on the STK500 board.

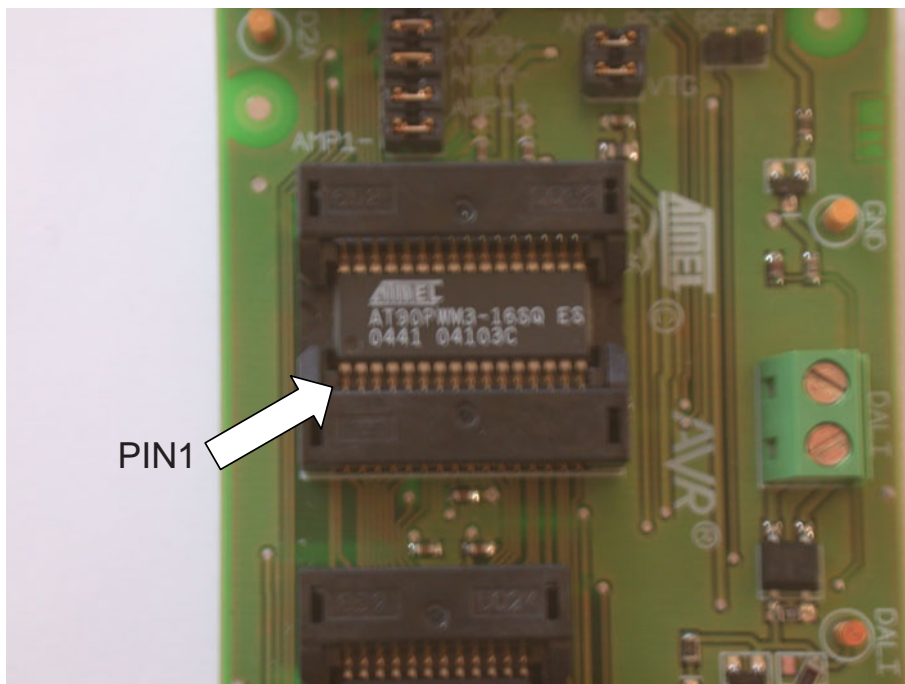
**Figure 2-1.** Connecting STK520 to the STK500 Board



**Note:** Connecting the STK520 with wrong orientation may damage the board.

- 2.1.1 Placing an AT90PWM3 on the STK520** The STK520 contains both a ZIF socket for a SO32 package. Care should be taken so that the device is mounted with the correct orientation. Figure 2-2 shows the location of pin1 for the ZIF socket.

**Figure 2-2.** Pin1 on ZIF Socket

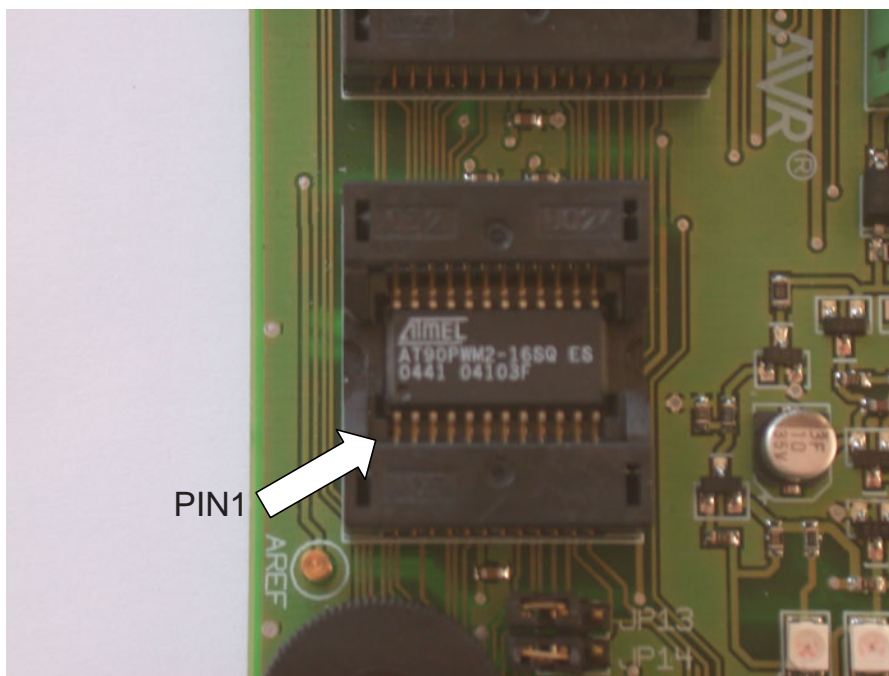


**Caution:** Do not mount an AT90PWM3 on the STK520 at the same time as an AVR is mounted on the STK500 board or at the same time as an AT90PWM2 is mounted on the STK520 board. None of the devices might work as intended.

### 2.1.2 Placing an AT90PWM2 on the STK520

The STK520 contains both a ZIF socket for a SO24 package. Care should be taken so that the device is mounted with the correct orientation. Figure 2-2 shows the location of pin1 for the ZIF socket.

**Figure 2-3.** Pin1 on ZIF Socket



**Caution:** Do not mount an AT90PWM2 on the STK520 at the same time as an AVR is mounted on the STK500 board or at the same time as an AT90PWM3 is mounted on the STK520 board. None of the devices might work as intended.

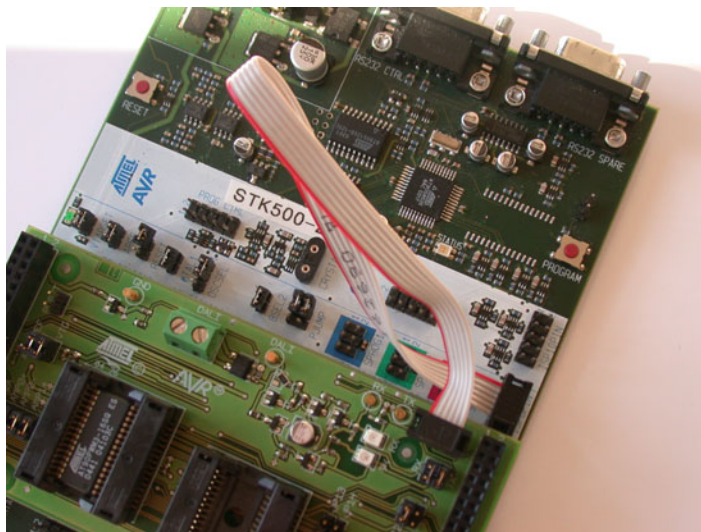
## 2.2 Programming the AVR

The AVR (AT90PWM2, AT90PWM3...) can be programmed using both SPI and High-voltage Parallel Programming. This section will explain how to connect the programming cables to successfully use one of these two modes. The AVR Studio STK500 software is used in the same way as for other AVR parts

**Note:** The AT90PWM3 also support Self Programming, See AVR109 application note for more information on this topic.

### 2.2.1 In-System Programming

**Figure 2-4.** In-System Programming



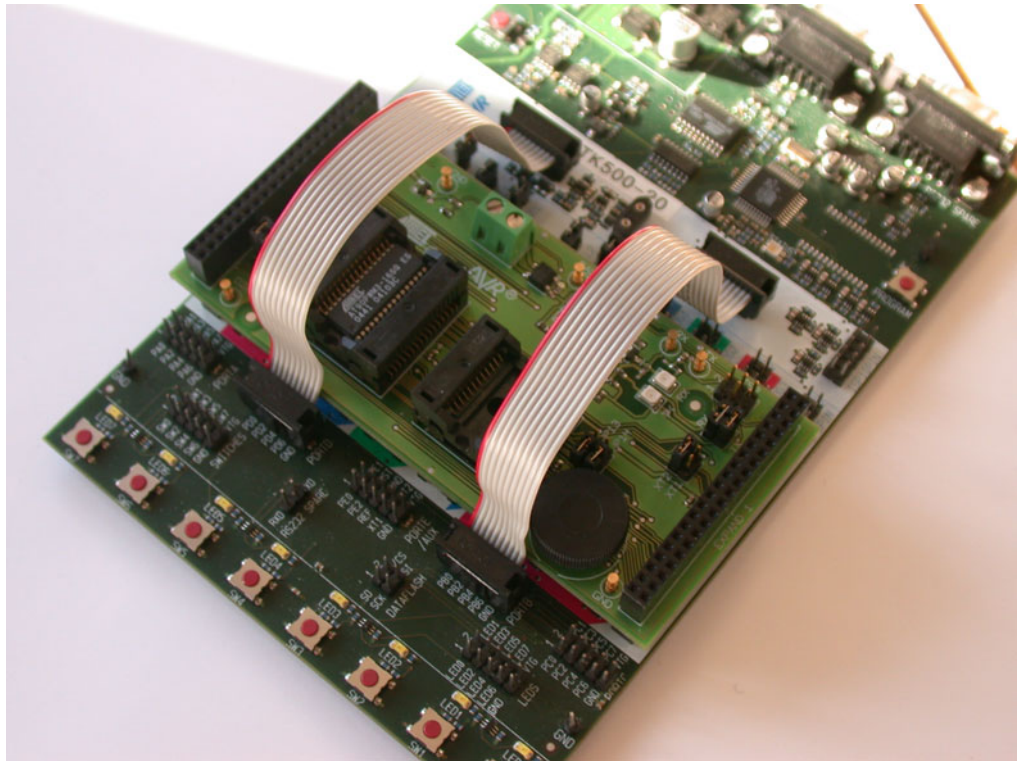
To program the AT90PWM3 using ISP Programming mode, connect the 6-wire cable between the ISP6PIN connector on the STK500 board and the ISP connector on the STK520 board as shown in Figure 2-4. The device can be programmed using the Serial Programming mode in the AVR Studio4 STK500 software.

**Note:** See STK500 User Guide for information on how to use the STK500 front-end software for ISP Programming.



## 2.2.2 High-voltage Programming

**Figure 2-5.** High-voltage (Parallel) Programming



To program the AVR using High-voltage (Parallel) Programming, connect the PROGCTRL to PORTD and PROGDATA to PORTB on the STK500 as shown in Figure 2-5. Make sure that the TOSC-switch is placed in the XTAL position.

As described in the STK500 User Guide (jumper settings), mount the BSEL2 jumper in order to High-voltage Program the ATmega devices. This setting also applies to High-voltage Programming of the AVR.

The device can now be programmed using the High-voltage Programming mode in AVR Studio STK500 software.

**Note:** See the STK500 User Guide for information on how to use the STK500 front-end software in High-voltage Programming mode.

**Note:** For the High-voltage Programming mode to function correctly, the target voltage must be higher than 4.5V.

## 2.3 JTAGICE mkII Connector

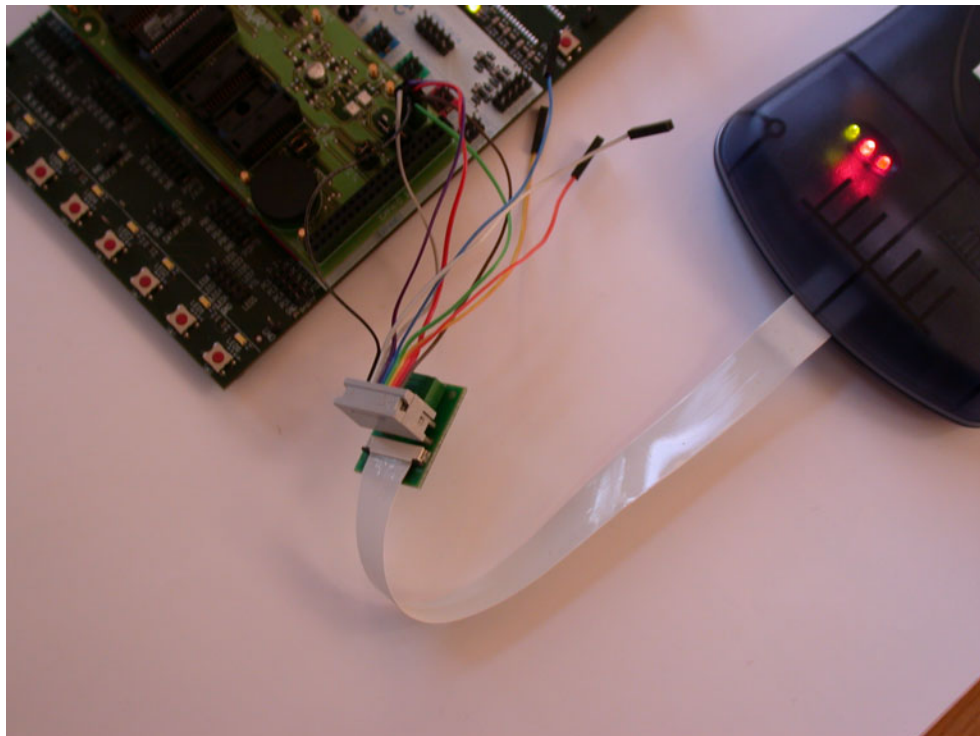
See the following document :

“JTAGICE mkII Quick Start Guide” which purpose is “Connecting to a target board with the AVR JTAGICE mkII”.

This note explains which signals are required for ISP and which signals are required for debugWIRE.

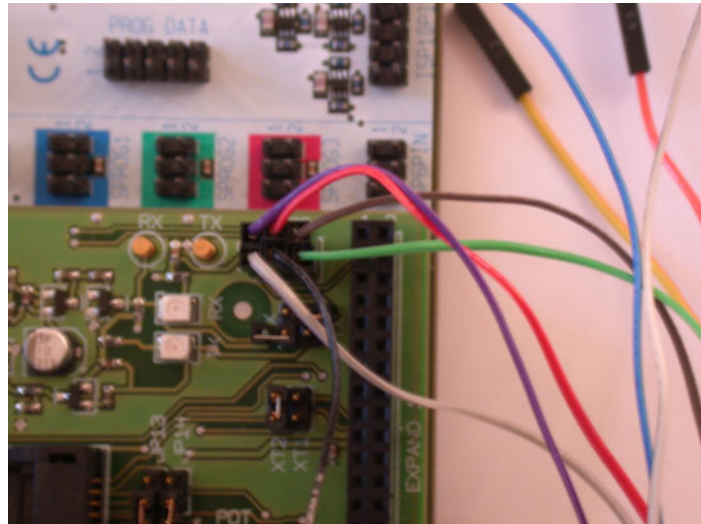
Figure 2-6 shows how to connect the JTAGICE mkII probe on the STK520 board.

**Figure 2-6.** Connecting JTAG ICE to the STK520



The ISP connector is used for the AT90PWM3 built-in debugWire interface. The pin out of the connector is shown in Table 2-1 and is compliant with the pin out of the JTAG ICE available from Atmel. Connecting a JTAG ICE to this connector allows On-chip Debugging of the AT90PWM3.

More information about the JTAG ICE and On-chip Debugging can be found in the AVR JTAG ICE User Guide, which is available at the Atmel web site, [www.atmel.com](http://www.atmel.com).

**Figure 2-7.** JTAG Connector**Table 2-1.** STK520 ISP Connector Pinout

Squid Cable Colours	Target pins	STK520 ISP pinout		Target pins	Squid Cable Colours
grey	MISO	1	2	VTG	purple
black	SCK	3	4	MOSI	red
green	RESET	5	6	GND	brown

## 2.4 STK520 Jumpers, Leds & Test Points

**Table 2-2.** STK520 Jumpers

Jumper	Function	Description
JP1	XT1	Connect STK500 XT1 circuit to AVR PE1
JP2	XT2	Connect STK500 XT2 circuit to AVR PE2
JP3	RESET	Connect STK500 RESET circuit to AVR PE0
JP4	RX	Connect RxD DALI to RxD Input of the AVR
JP5	TX	Connect TxD DALI to TxD Output of the AVR
JP6	VTG	Useful to measure the VCC and AVCC current
JP7	ANA REF	Connect STK500 REF circuit to AVR AREF
JP8	D2A	Isolate D2A output
JP9	AMP0+	Isolate AMP0+ input
JP10	AMP0-	Isolate AMP0- input
JP11	AMP1+	Isolate AMP1+ input
JP12	AMP1-	Isolate AMP1- input
JP13		Potentiometer supply from Analog V Ref
JP14		Potentiometer output to ADC0 input

**Table 2-3.** STK520 Leds

Led	Function	Description
D3	RX	RX data detected by DALI Interface
D4	TX	TX data sent to DALI Interface

**Table 2-4.** STK520 Test Points

Test Point	Function	Description
T1	GND	Electrical ground of the STK520 board
T2	GND	Electrical ground of the STK520 board
T3	AREF	AREF pin of the AVR
T4	D2A	D2A output of the AVR
T5	DALI	Rectified DALI line
T6	Tx	TX data sent to DALI Interface
T7	Rx	RX data detected by DALI Interface

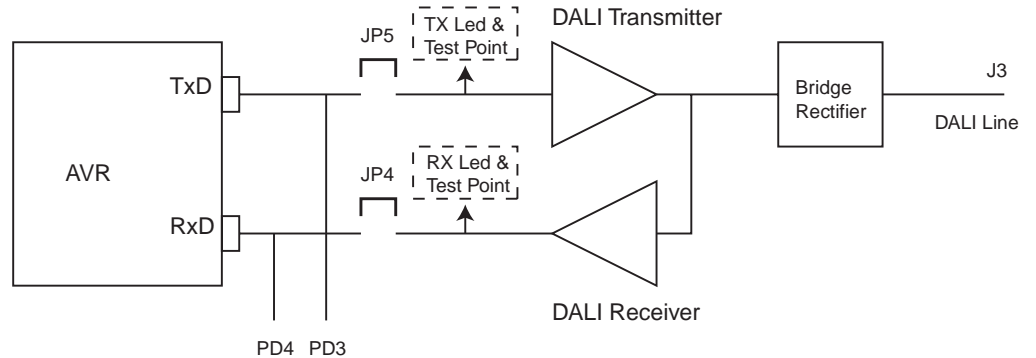
## 2.5 DALI Interface

STK520 includes a non-isolated DALI Interface. The DALI Interface converts AVR RxD and TxD pin level to DALI compatible electrical level. It acts as a duplexer, so it interfaces the two RxD and TxD lines to one DALI line.

To use the DALI Interface, it is necessary to mount TxD and RxD jumpers. When these jumpers are removed, the AVR is not influenced by the interface. The TxD and RxD AVR pins are also available on STK500 PD3 and PD4 connectors.

Thanks to a diode bridge, the DALI connector is not polarized.

**Figure 2-8.** DALI



**Figure 2-9.** DALI Connector

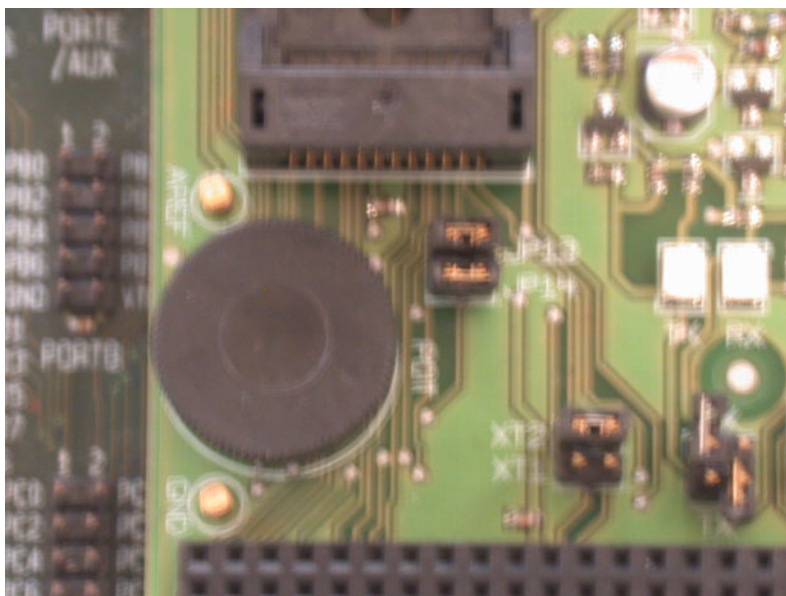


## 2.6 Potentiometer

The STK520 includes a potentiometer. To use the potentiometer, please mount JP13 and JP14 jumper.

The potentiometer is supplied by AREF and it delivers a voltage to the AVR ADC0 input.

**Figure 2-10.** Potentiometer



### 2.6.0.1 XT1 Jumper

As the jumper JP1 (XT1) is short circuited by Printed Circuit Board wire, it's always ON. So it's not mounted. To open this jumper, it's necessary to cut the wire between JP1 pin (solder side).

It's possible to open XTAL1 circuit which comes from STK500 board by removing the XTAL1 jumper on the STK500 board.

### 2.6.0.2 RESET Jumper

As the jumper JP3 (RESET) is short circuited by Printed Circuit Board wire, it's always ON. So it's not mounted. To open this jumper, it's necessary to cut the wire between JP3 pin (solder side).

It's possible to open RESET circuit which comes from STK500 board by removing the RESET jumper on the STK500 board.



## Section 3

# Troubleshooting Guide

**Table 3-1.** Troubleshooting Guide

Problem	Reason	Solution
Serial Programming does not work	ISP cable not connected.	Connect the ISP cable according to Figure 2-4.
	STK500 target voltage error.	Please refer to the AT90PWM3 datasheet for the Serial Programming Voltage limits. Adjust the target voltage on the STK500 board accordingly.
	The RSTDISBL Fuse is programmed.	Use Parallel Programming to unprogram the RSTDISBL Fuse.
Parallel Programming does not work.	Cables not connected properly.	Please refer to Figure 2-5 for correct Parallel Programming setup.
	STK500 target voltage error.	Please refer to the AT90PWM3 data sheet for the Parallel Programming Voltage limits. Adjust the target voltage on the STK500 board accordingly.
Emulation does not work.	ISP cable not connected.	Connect the ISP cable according to Figure 2-7.
	Conflict with STK500 Reset	Remove Reset Jumper on STK500 Board
	DWEN fuse is not programmed	Please set the DWEN bit using parallel programming
	The RSTDISBL Fuse is programmed.	Use Parallel Programming to unprogram the RSTDISBL Fuse.

- Note: 1. See the application note “AVR065: LCD Driver for the STK520 LCD” on how to control the LCD-display or the the application note “AVR064: STK520 – A Temperature Monitoring System with LCD Output”.

## Section 4

---

# Technical Specifications

### System Unit

Physical Dimensions . . . . . 56 x 119 x 27 mm  
Weight . . . . . 70 g

### Operating Conditions

Voltage Supply . . . . . 1,8V - 5,5V  
Temperature . . . . . 0°C - 50°C

### DALI Interface

Maximum DALI Voltage . . . . . 25V  
Maximum Input DALI Current . . . . . 500mA



## Section 5

---

# Technical Support

For Technical support, please contact [avr@atmel.com](mailto:avr@atmel.com). When requesting technical support, please include the following information:

- Which target AVR device is used (complete part number).
- Target voltage and speed.
- Clock source and fuse setting of the AVR.
- Programming method (ISP or High-voltage).
- Hardware revisions of the AVR tools, found on the PCB.
- Version number of AVR Studio. This can be found in the AVR Studio help menu.
- PC operating system and version/build.
- PC processor type and speed.
- A detailed description of the problem.



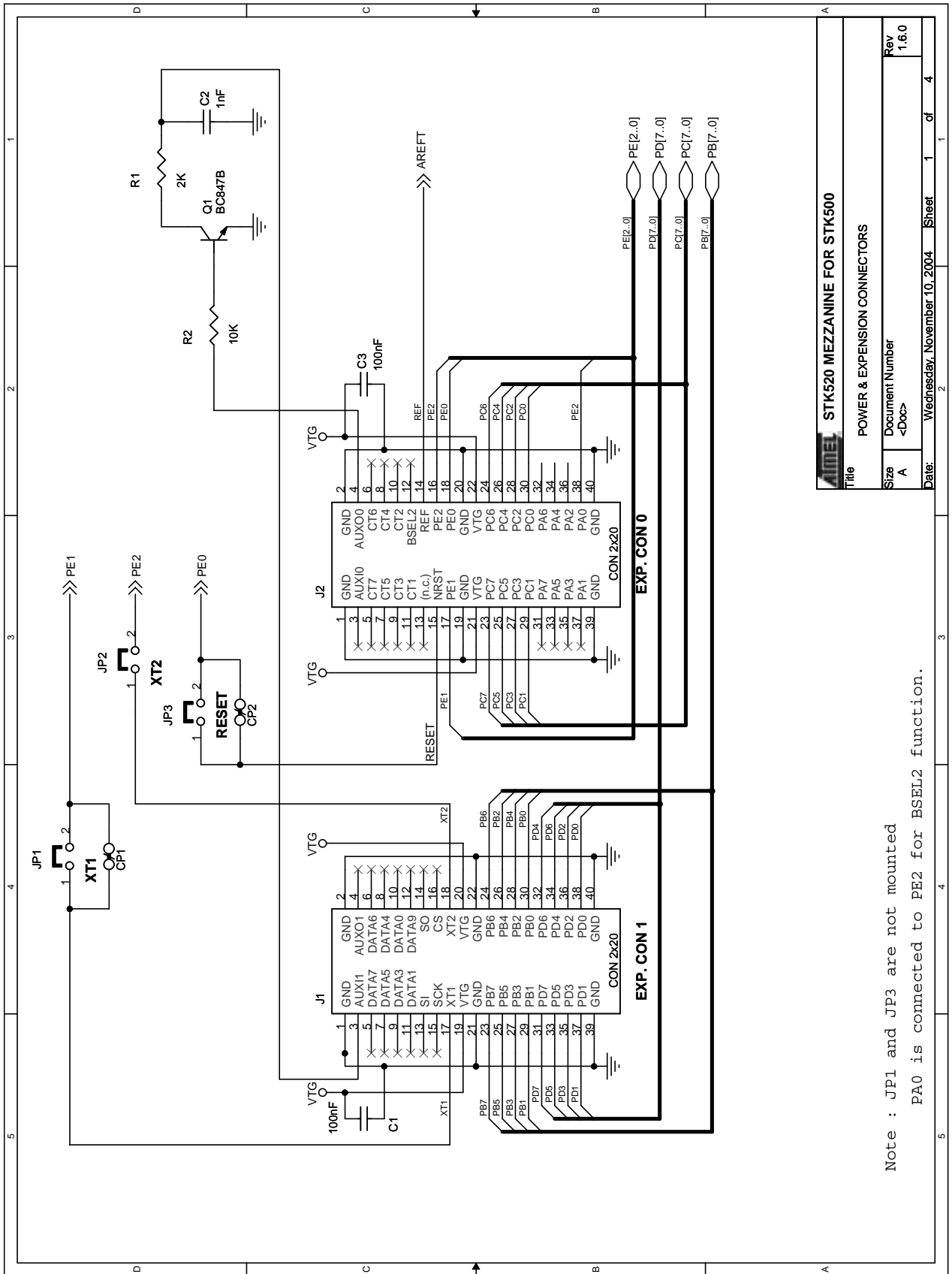
## Section 6

---

# Complete Schematics

On the following pages the complete schematics and assembly drawing of the STK520 revision A are shown.

Figure 6-1. Schematics, 1 of 4

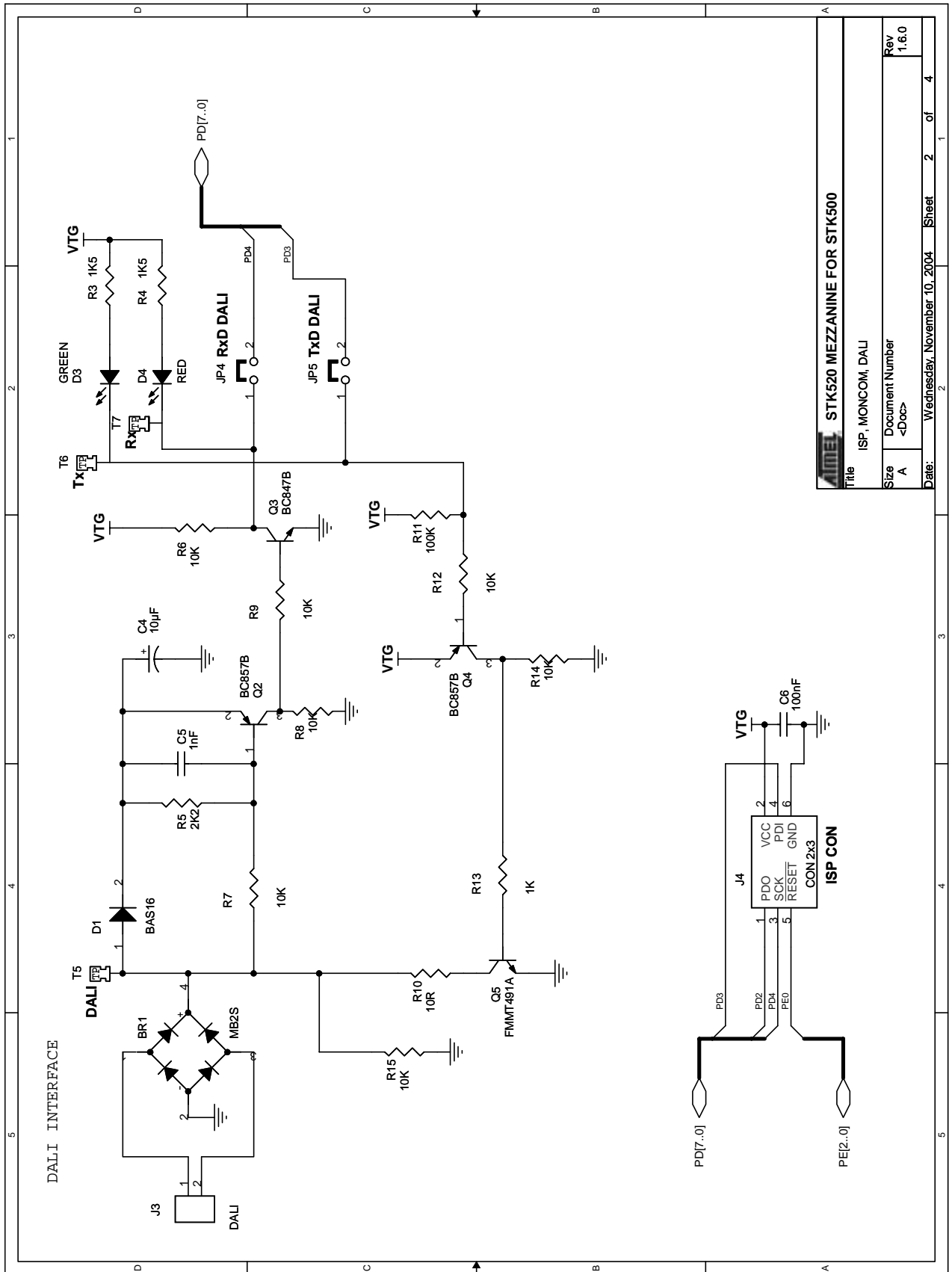


Title		STK520 MEZZANINE FOR STK500	
POWER & EXPANSION CONNECTORS			
Size	Document Number	Rev	1.6.0
A	<Doc>		
Date:	Wednesday, November 10, 2004	Sheet	1 of 4

Note : JP1 and JP3 are not mounted  
 PA0 is connected to PE2 for BSEL2 function.

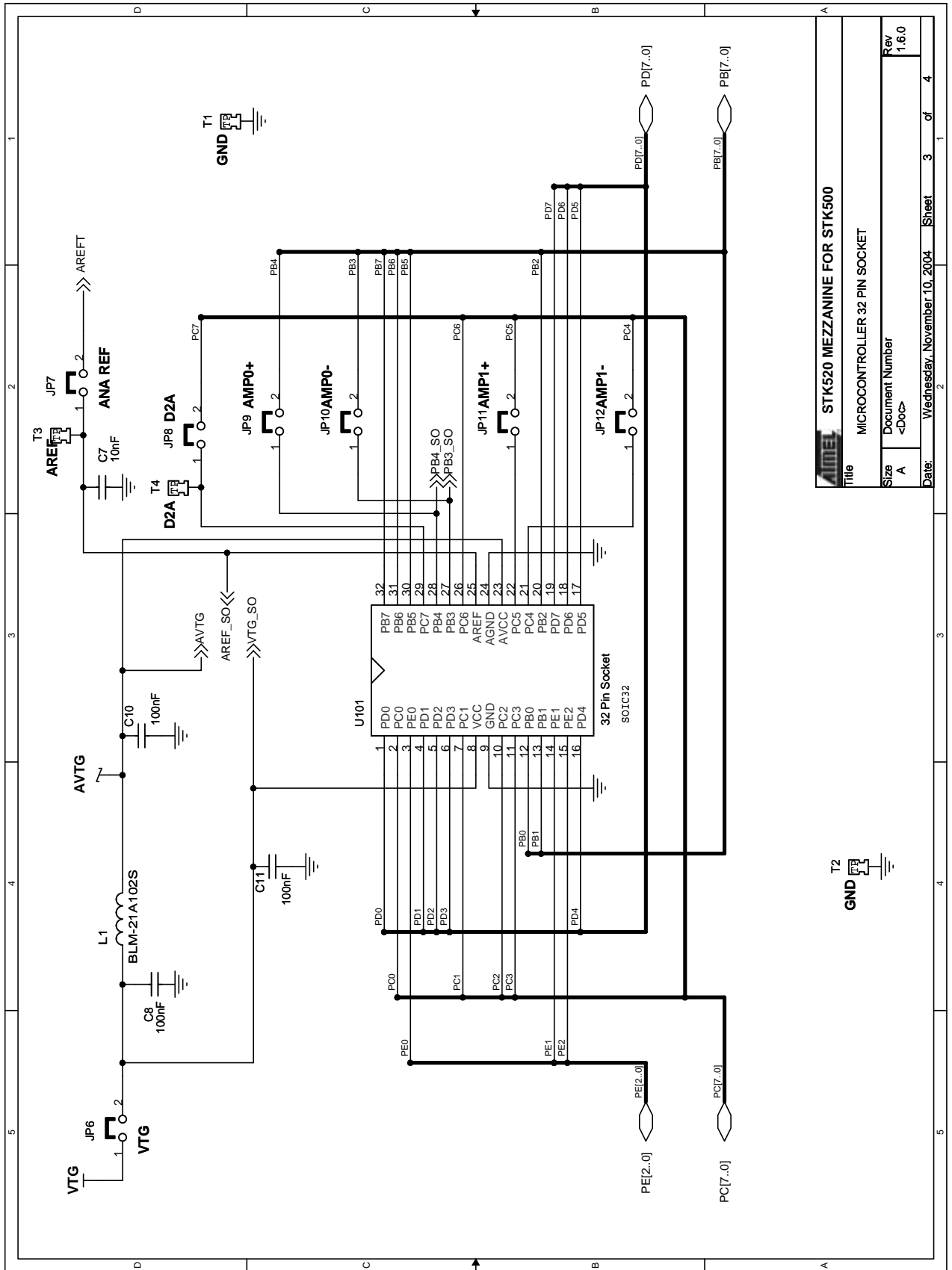


Figure 6-2. Schematics, 2 of 4



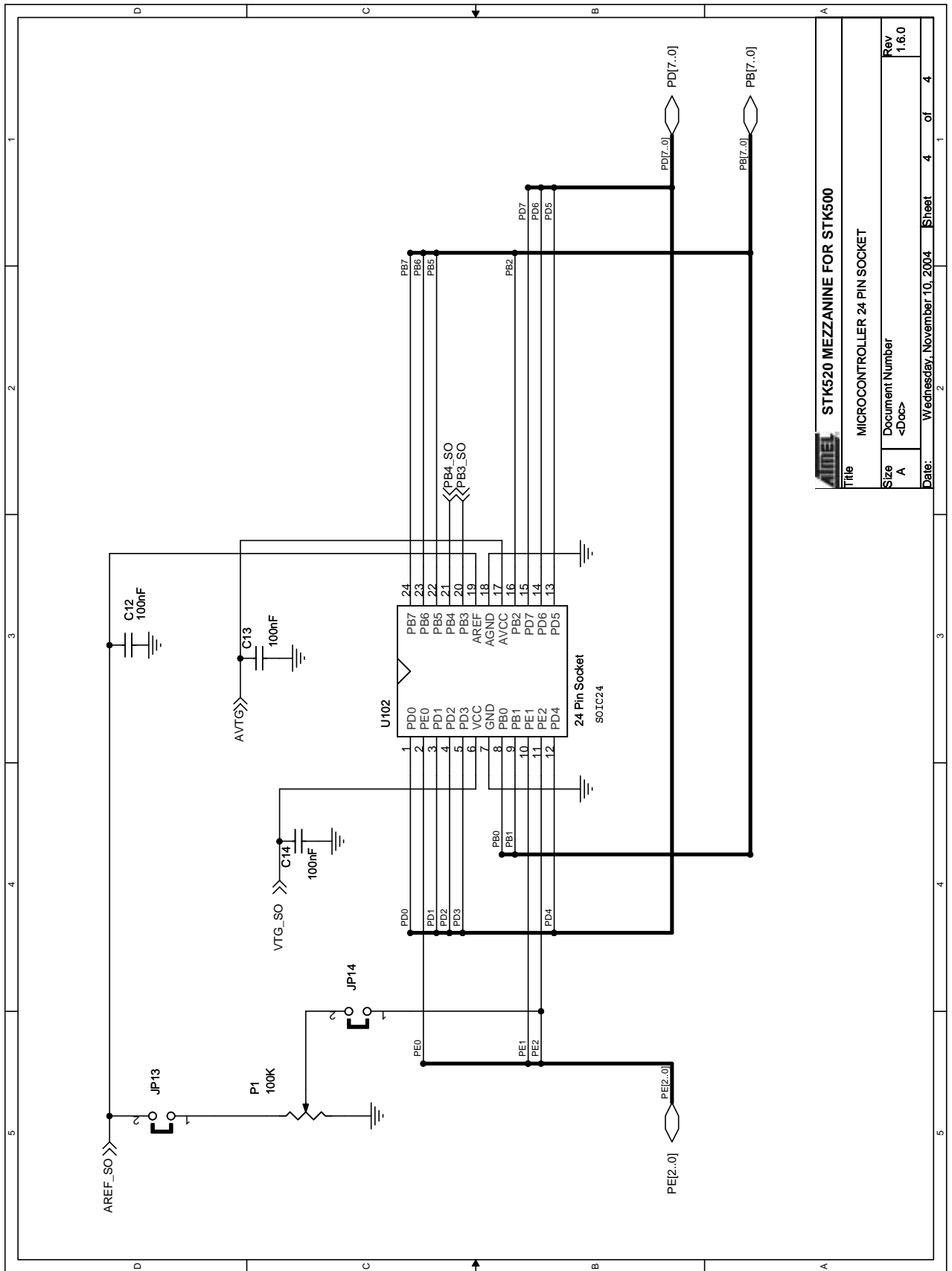
Title		ISP, MONCOM, DALI	
Size		A	
Document Number		<Doc>	
Rev		1.6.0	
Date:	Wednesday, November 10, 2004	Sheet	2 of 4

Figure 6-3. Schematics, 3 of 4



Title		STK520 MEZZANINE FOR STK500	
Size		MICROCONTROLLER 32 PIN SOCKET	
Doc#	Rev	Doc#	Rev
A	1.6.0	<Doc#>	1.6.0
Date:	Wednesday, November 10, 2004	Sheet	3 of 4

Figure 6-4. Schematics, 4 of 4







## Atmel Headquarters

### Corporate Headquarters

2325 Orchard Parkway  
San Jose, CA 95131  
TEL 1(408) 441-0311  
FAX 1(408) 487-2600

### Europe

Atmel Sarl  
Route des Arsenaux 41  
Case Postale 80  
CH-1705 Fribourg  
Switzerland  
TEL (41) 26-426-5555  
FAX (41) 26-426-5500

### Asia

Room 1219  
Chinachem Golden Plaza  
77 Mody Road Tsimhatsui  
East Kowloon  
Hong Kong  
TEL (852) 2721-9778  
FAX (852) 2722-1369

### Japan

9F, Tonetsu Shinkawa Bldg.  
1-24-8 Shinkawa  
Chuo-ku, Tokyo 104-0033  
Japan  
TEL (81) 3-3523-3551  
FAX (81) 3-3523-7581

## Atmel Operations

### Memory

2325 Orchard Parkway  
San Jose, CA 95131  
TEL 1(408) 441-0311  
FAX 1(408) 436-4314

### Microcontrollers

2325 Orchard Parkway  
San Jose, CA 95131  
TEL 1(408) 441-0311  
FAX 1(408) 436-4314

La Chantrerie  
BP 70602  
44306 Nantes Cedex 3, France  
TEL (33) 2-40-18-18-18  
FAX (33) 2-40-18-19-60

### ASIC/ASSP/Smart Cards

Zone Industrielle  
13106 Rousset Cedex, France  
TEL (33) 4-42-53-60-00  
FAX (33) 4-42-53-60-01

1150 East Cheyenne Mtn. Blvd.  
Colorado Springs, CO 80906  
TEL 1(719) 576-3300  
FAX 1(719) 540-1759

Scottish Enterprise Technology Park  
Maxwell Building  
East Kilbride G75 0QR, Scotland  
TEL (44) 1355-803-000  
FAX (44) 1355-242-743

### RF/Automotive

Theresienstrasse 2  
Postfach 3535  
74025 Heilbronn, Germany  
TEL (49) 71-31-67-0  
FAX (49) 71-31-67-2340

1150 East Cheyenne Mtn. Blvd.  
Colorado Springs, CO 80906  
TEL 1(719) 576-3300  
FAX 1(719) 540-1759

### Biometrics/Imaging/Hi-Rel MPU/ High Speed Converters/RF Datacom

Avenue de Rochepleine  
BP 123  
38521 Saint-Egreve Cedex, France  
TEL (33) 4-76-58-30-00  
FAX (33) 4-76-58-34-80

---

### e-mail

[literature@atmel.com](mailto:literature@atmel.com)

### Web Site

<http://www.atmel.com>

Disclaimer: The information in this document is provided in connection with Atmel products. No license, express or implied, by estoppel or otherwise, to any intellectual property right is granted by this document or in connection with the sale of Atmel products. **EXCEPT AS SET FORTH IN ATMEL'S TERMS AND CONDITIONS OF SALE LOCATED ON ATMEL'S WEB SITE, ATMEL ASSUMES NO LIABILITY WHATSOEVER AND DISCLAIMS ANY EXPRESS, IMPLIED OR STATUTORY WARRANTY RELATING TO ITS PRODUCTS INCLUDING, BUT NOT LIMITED TO, THE IMPLIED WARRANTY OF MERCHANTABILITY, FITNESS FOR A PARTICULAR PURPOSE, OR NON-INFRINGEMENT. IN NO EVENT SHALL ATMEL BE LIABLE FOR ANY DIRECT, INDIRECT, CONSEQUENTIAL, PUNITIVE, SPECIAL OR INCIDENTAL DAMAGES (INCLUDING, WITHOUT LIMITATION, DAMAGES FOR LOSS OF PROFITS, BUSINESS INTERRUPTION, OR LOSS OF INFORMATION) ARISING OUT OF THE USE OR INABILITY TO USE THIS DOCUMENT, EVEN IF ATMEL HAS BEEN ADVISED OF THE POSSIBILITY OF SUCH DAMAGES.** Atmel makes no representations or warranties with respect to the accuracy or completeness of the contents of this document and reserves the right to make changes to specifications and product descriptions at any time without notice. Atmel does not make any commitment to update the information contained herein. Unless specifically provided otherwise, Atmel products are not suitable for, and shall not be used in, automotive applications. Atmel's products are not intended, authorized, or warranted for use as components in applications intended to support or sustain life.  
© Atmel Corporation 2005. All rights reserved. Atmel®, logo and combinations thereof, are registered trademarks, and Everywhere You Are<sup>SM</sup> are the trademarks of Atmel Corporation or its subsidiaries. Other terms and product names may be trademarks of others.



Printed on recycled paper.