

### 1. PART NO. EXPRESSION :

$\frac{S}{(a)} \frac{D}{(b)} \frac{S}{(c)} \frac{2}{(d)} \frac{5}{(e)} \frac{2}{(f)} \frac{0}{(g)} \frac{1}{(h)} \frac{0}{(i)} \frac{D}{(j)} \frac{1}{(k)} \frac{0}{(l)} \frac{0}{(m)} \frac{M}{(n)} \frac{F}{(o)}$

- (a) Series code
- (b) Dimension code
- (c) Material code
- (d) Inductance code : 100 = 10.0uH
- (e) Tolerance code : M = ±20%
- (f) F : RoHS Compliant

### 2. CONFIGURATION & DIMENSIONS :

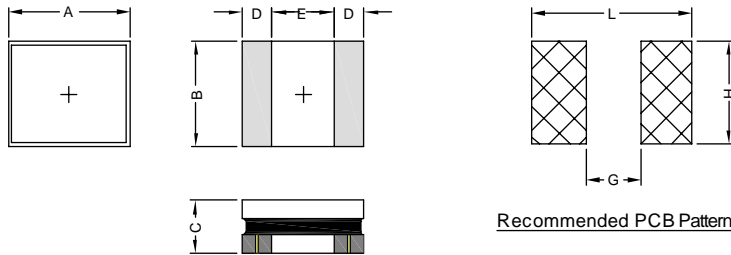

Unit: m/m

A	B	C	D	E	L	G	H
2.5 -0.1/+0.2	2.0 -0.05/+0.35	1.02 Max.	0.85 Ref.	0.80 Ref.	2.9 Ref.	0.8 Ref.	2.4 Ref.

### 3. MATERIALS :

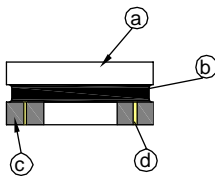

- (a) Core : Ferrite Core
- (b) Coating : Epoxy with magnetic powder
- (c) Termination : Tin Pb Free
- (d) Wire : Enameled Copper Wire

Exposed wire tolerance limit of coating resin part on product side.

Size of exposed wire occurring to coating resin is specified below.

1. Width direction ( dimension a ) : Acceptable when  $a \leq w/2$   
Nonconforming when  $a > w/2$
2. Length direction ( dimension b ) : Dimension b is not specified.
3. The total area of exposed wire occurring to each sides is not greater than 50% of coating resin area, and is acceptable.

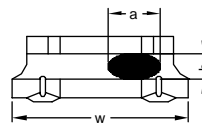

**RoHS Compliant**

NOTE : Specifications subject to change without notice. Please check our website for latest information.



**SUPERWORLD ELECTRONICS (S) PTE LTD**

16.01.2014

#### 4. GENERAL SPECIFICATION :

- a) ambient temp. : 25° C
- b) Isat : Based on inductance change ( $\Delta L/L0$  :  $\leq -30\%$ )
- c) Irms : Based on temperature rise ( $\Delta T$  : 40°C) Max
- d) Operating temp. : -55° C to 125° C (for products in unopened tape package, less than 40° C)

#### 5. ELECTRICAL CHARACTERISTICS :

Part No.	Inductance ( $\mu$ H )	Test Frequency ( Hz )	DCR ( $\Omega$ ) $\pm 20\%$	Isat (A) Typ.	Irms (A) Typ.
SDS252010D100MF	10 $\pm 20\%$	0.1V/1M	0.47	0.75	0.75
SDS252010D220MF	22 $\pm 20\%$	0.1V/1M	1.120	0.50	0.50



**RoHS Compliant**

NOTE : Specifications subject to change without notice. Please check our website for latest information.

16.01.2014



**SUPERWORLD ELECTRONICS (S) PTE LTD**

PG. 2

### 6. CHARACTERISTICS CURVES :

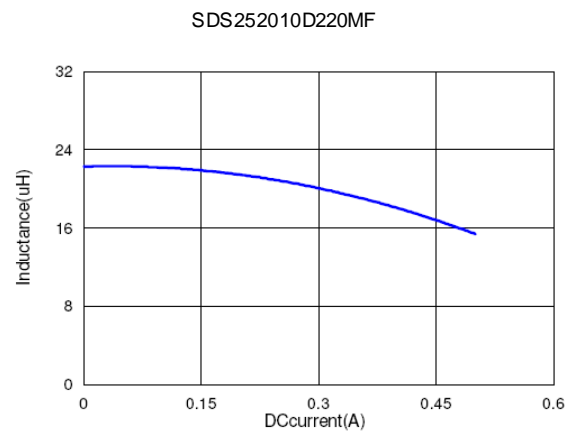
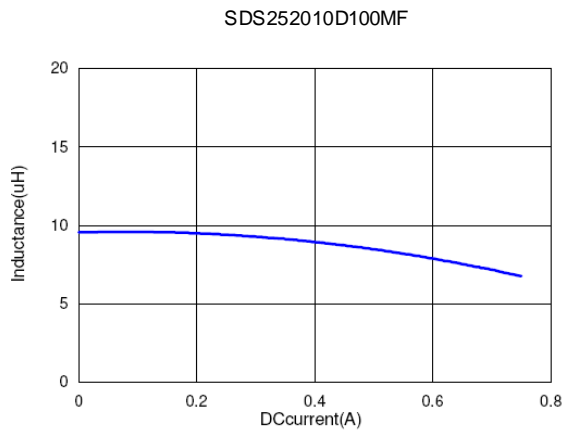

**RoHS Compliant**

NOTE : Specifications subject to change without notice. Please check our website for latest information.

16.01.2014



**SUPERWORLD ELECTRONICS (S) PTE LTD**

### 7. RELIABILITY AND TEST CONDITION :

ITEM	PERFORMANCE	TEST CONDITION								
Electrical Characteristics Test										
Inductance L	Refer to standard electrical characteristics list	Agilent-4291, Agilent-4287								
Q		Agilent-4192, Agilent-4285								
SRF		Agilent-4291								
DC Resistance		Agilent-4338								
Rated Current	Base on temp. rise & $\Delta L/L_0 \cong 30\%$ .	Saturation DC Current (Isat) will cause L0 to drop approximately $\Delta L(\%)$ .								
Temperature Rise Test	$\Delta T 40^\circ\text{CMax}$	Heat Rated Current (Irms) will cause the coil temperature rise approximately $\Delta T(^\circ\text{C})$ without core loss. 1. Applied the allowed DC current. 2. Temperature measured by digital surface thermometer								
Mechanical Performance Test										
Solder Heat Resistance	Appearance : No damage. Inductance : within $\pm 10\%$ of initial value Q : Shall not exceed the specification value. RDC : within $\pm 15\%$ of initial value and shall not exceed the specification value	<table border="1"> <thead> <tr> <th>Temperature (<math>^\circ\text{C}</math>)</th> <th>Time (s)</th> <th>Temperature ramp/immersion and emersion rate</th> <th>Number of heat cycles</th> </tr> </thead> <tbody> <tr> <td>260<math>\pm</math>5 (solder temp)</td> <td>10<math>\pm</math>1</td> <td>25mm/s<math>\pm</math>6 mm/s</td> <td>1</td> </tr> </tbody> </table> <p>Depth: completely cover the termination</p>	Temperature ( $^\circ\text{C}$ )	Time (s)	Temperature ramp/immersion and emersion rate	Number of heat cycles	260 $\pm$ 5 (solder temp)	10 $\pm$ 1	25mm/s $\pm$ 6 mm/s	1
Temperature ( $^\circ\text{C}$ )	Time (s)	Temperature ramp/immersion and emersion rate	Number of heat cycles							
260 $\pm$ 5 (solder temp)	10 $\pm$ 1	25mm/s $\pm$ 6 mm/s	1							
Solderability Test	More than 95% of terminal electrode should be covered with solder.	Preheat : 150 $^\circ\text{C}$ , 60sec Solder : Sn99.5%-Cu0.5% Temperature : 245 $\pm$ 5 $^\circ\text{C}$ Flux for lead free : Rosin. 9.5% Dip time : 4 $\pm$ 1sec Depth : completely cover the termination								
Reliability Test										
Life Test	Appearance : No damage. Inductance : within $\pm 10\%$ of initial value Q : Shall not exceed the specification value. RDC : within $\pm 15\%$ of initial value and shall not exceed the specification value	Preconditioning: Run through IR reflow for 2 times. (IPC/ JEDEC J-STD-020D Classification Reflow Profiles Temperature : 85 $\pm$ 2 $^\circ\text{C}$ (Inductor) Applied current : rated current Duration : 1000 $\pm$ 12hrs Measured at room temperature after placing for 24 $\pm$ 2 hrs								
Thermal shock		Preconditioning: Run through IR reflow for 2 times. (IPC/ JEDEC J-STD-020D Classification Reflow Profiles Step1 : -40 $\pm$ 2 $^\circ\text{C}$ 30 $\pm$ 5min Step2 : 25 $\pm$ 2 $^\circ\text{C}$ $\cong$ 0.5min Step3 : 105 $\pm$ 2 $^\circ\text{C}$ 30 $\pm$ 5min Number of cycles : 500 Measured at room temperature after placing for 24 $\pm$ 2 hrs								
Humidity Resistance Test		Preconditioning: Run through IR reflow for 2 times. (IPC/ JEDEC J-STD-020D Classification Reflow Profiles Humidity : 85 $\pm$ 2% R.H Temperature : 85 $^\circ\text{C}$ $\pm$ 2 $^\circ\text{C}$ Duration : 1000hrs Min. with 100% rated current Measured at room temperature after placing for 24 $\pm$ 2 hrs								
Vibration Test		Preconditioning: Run through IR reflow for 2 times. (IPC/ JEDEC J-STD-020D Classification Reflow Profiles Oscillation Frequency : 10~2K~10Hz for 20 minutes Equipment : Vibration checker Total Amplitude : 1.52mm $\pm$ 10% Testing Time : 12 hours (20 minutes, 12 cycles each of 3 orientations)								

NOTE : Specifications subject to change without notice. Please check our website for latest information.

16.01.2014



### 8. SOLDERING AND MOUNTING :

#### 8-1. Soldering

Mildly activated rosin fluxes are preferred. Our terminations are suitable for all wave and re-flow soldering systems. If hand soldering cannot be avoided, the preferred technique is the utilization of hot air soldering tools.

#### 8-1.1 Lead Free Solder Re-flow :

Recommended temperature profiles for re-flow soldering in Figure 1.

#### 8-1.2 Soldering Iron (Figure 2) :

Products attachment with soldering iron is discouraged due to the inherent process control limitations. In the event that a soldering iron must be employed the following precautions are recommended.

Note :

- a) Preheat circuit and products to 150° C.
- b) 355° C tip temperature (max)
- c) Never contact the ceramic with the iron tip
- d) 1.0mm tip diameter (max)
- e) Use a 20 watt soldering iron with tip diameter of 1.0mm
- f) Limit soldering time to 4-5 secs.

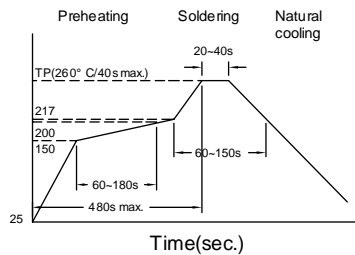

Figure 1. Re-flow Soldering : 3 times max.

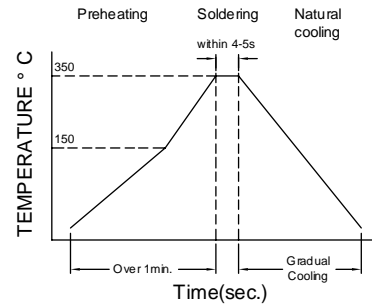

Figure 2. Iron Soldering : 1 times max.



**RoHS Compliant**

NOTE : Specifications subject to change without notice. Please check our website for latest information.

16.01.2014



**SUPERWORLD ELECTRONICS (S) PTE LTD**

### 9. PACKAGING INFORMATION :

#### 9-1. Reel Dimension

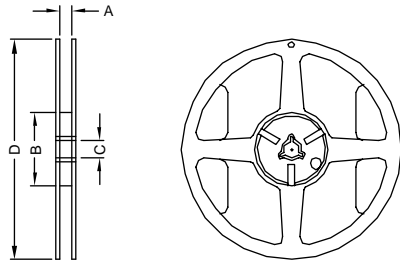

7" x 8mm

Type	A(mm)	B(mm)	C(mm)	D(mm)
7" x 8mm	8.4± 1.0	50 Min.	13± 0.8	178± 2

#### 9-2 Tape Dimension / 8mm

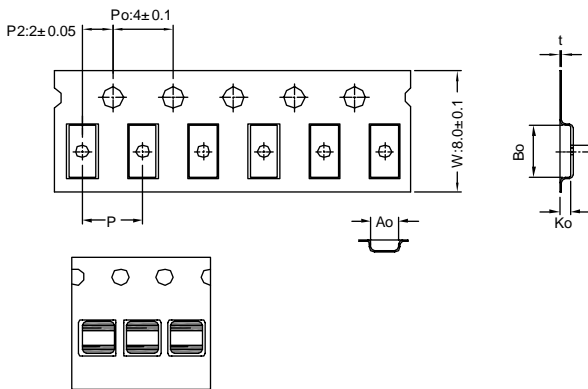

Bottom View

Series	Ao(mm)	Bo(mm)	Ko(mm)	P(mm)	t(mm)
SDS252010D	2.45± 0.1	2.85± 0.1	1.40± 0.1	4.0± 0.1	0.23± 0.05

#### 9-3. Packaging Quantity

Size	SDS252010D
Chip / Reel	2000



**RoHS Compliant**

NOTE : Specifications subject to change without notice. Please check our website for latest information.

16.01.2014



**SUPERWORLD ELECTRONICS (S) PTE LTD**

### 9-4. Tearing Off Force

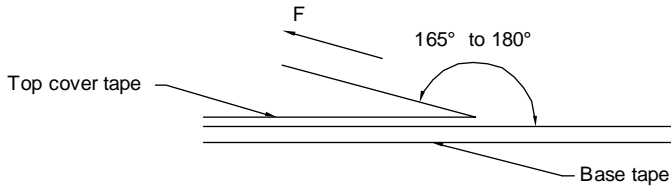

The force for tearing off cover tape is 15 to 80 grams in the arrow direction under the following conditions.

Room Temp. (° C)	Room Humidity (%)	Room atm (hPa)	Tearing Speed (mm/min)
5~35	45~85	860~1060	300

### Application Notice

#### 1. Storage Conditions :

To maintain the solderability of terminal electrodes :

- Temperature and humidity conditions : Less than 40° C and 60% RH.
- Recommended products should be used within 12 months from the time of delivery.
- The packaging material should be kept where no chlorine or sulfur exists in the air.

#### 2. Transportation :

- Products should be handled with care to avoid damage or contamination from perspiration and skin oils.
- The use of tweezers or vacuum pick up is strongly recommended for individual components.
- Bulk handling should ensure that abrasion and mechanical shock are minimized.



**RoHS Compliant**

NOTE : Specifications subject to change without notice. Please check our website for latest information.

16.01.2014



**SUPERWORLD ELECTRONICS (S) PTE LTD**