



N-Channel Enhancement Mode Power MOSFET

MTN10N60BE3

BV_{DSS}	600V
$I_D @ V_{GS}=10V, T_C=25^\circ C$	10A
$R_{DS(on)(TYP)} @ V_{GS}=10V, I_D=6A$	0.59Ω

Description

The MTN10N60BE3 is a N-channel enhancement-mode MOSFET, providing the designer with the best combination of fast switching, ruggedized device design, low on-resistance and cost effectiveness. The TO-220 package is universally preferred for all commercial-industrial applications

Features

- Low On Resistance
- Simple Drive Requirement
- Low Gate Charge
- Fast Switching Characteristic
- RoHS compliant package

Applications

- Power Factor Correction
- LCD TV Power
- Full and Half Bridge Power

Ordering Information

Device	Package	Shipping
MTN10N60BE3-0-UB-X	TO-220 (RoHS compliant package)	50 pcs/tube, 20 tubes/box, 4 boxes / carton

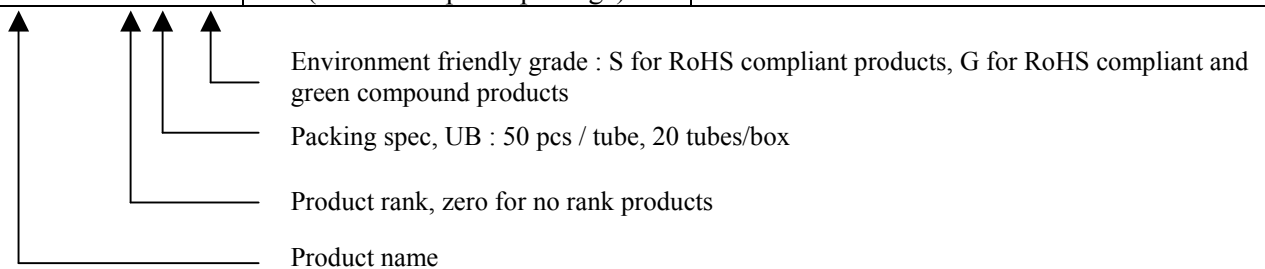

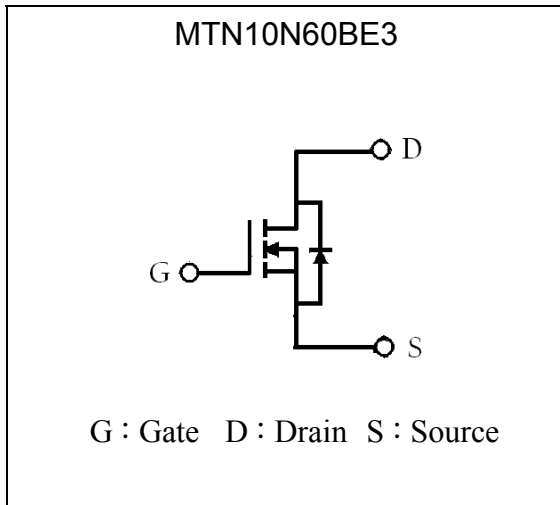
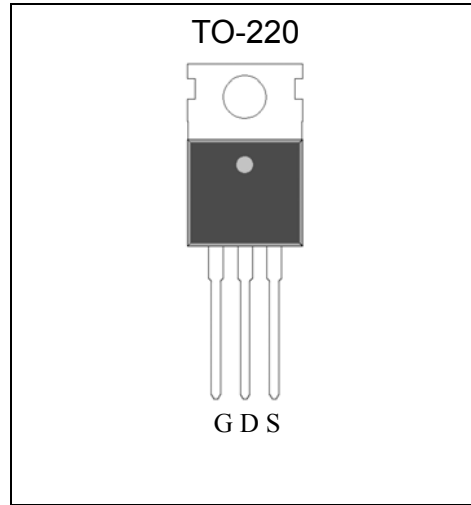
Symbol

Outline

Absolute Maximum Ratings (T_c=25°C)

Parameter	Symbol	Limits	Unit
Drain-Source Voltage (Note 1)	V _{DS}	600	V
Gate-Source Voltage	V _{GS}	±30	
Continuous Drain Current @V _{GS} =10V, T _c =25°C	I _D	10	A
Continuous Drain Current @V _{GS} =10V, T _c =100°C		6.3	
Pulsed Drain Current (Note 2)	I _{DM}	40	
Single Pulse Avalanche Energy @ L=5mH, I _D =10 Amps, V _{DD} =50V (Note 3)	E _{AS}	250	mJ
Repetitive Avalanche Energy	E _{AR}	5	
Maximum Temperature for Soldering @ Lead at 0.063 in(1.6mm) from case for 10 seconds	T _L	300	°C
Maximum Temperature for Soldering @ Package Body for 10 seconds	T _{PKG}	260	
Total Power Dissipation (T _c =25°C)	P _d	185	W
Linear Derating Factor		1.48	W/°C
Operating Junction and Storage Temperature	T _j , T _{stg}	-55~+150	°C

*Drain current limited by maximum junction temperature

Note : 1. T_J=+25°C to +150°C.

2. Repetitive rating; pulse width limited by maximum junction temperature.

3. 100% tested by conditions of L=5mH, I_{AS}=5A, V_{GS}=10V, V_{DD}=50V



Thermal Data

Parameter	Symbol	Value	Unit
Thermal Resistance, Junction-to-case, max	$R_{th,j-c}$	0.68	°C/W
Thermal Resistance, Junction-to-ambient, max	$R_{th,j-a}$	62.5	

Characteristics (Tj=25°C, unless otherwise specified)

Symbol	Min.	Typ.	Max.	Unit	Test Conditions
Static					
BV_{DSS}	600	-	-	V	$V_{GS}=0V, I_D=250\mu A$
$\Delta BV_{DSS}/\Delta T_j$	-	0.65	-	V/°C	Reference to 25°C, $I_D=250\mu A$
$V_{GS(th)}$	2.0	-	4.0	V	$V_{DS} = V_{GS}, I_D=250\mu A$
* G_{FS}	-	10.9	-	S	$V_{DS} = 15V, I_D=5A$
I_{GSS}	-	-	±100	nA	$V_{GS}=\pm 30V$
I_{DSS}	-	-	1	μA	$V_{DS} = 600V, V_{GS} = 0V$
I_{DSS}	-	-	10		$V_{DS} = 480V, V_{GS} = 0V, T_j=125^\circ C$
* $R_{DS(ON)}$	-	0.59	0.75	Ω	$V_{GS} = 10V, I_D=6A$
Dynamic					
* Q_g	-	43.4	-	nC	$I_D=10A, V_{DD}=300V, V_{GS}=10V$
* Q_{gs}	-	8.5	-		
* Q_{gd}	-	18	-		
* $t_{d(ON)}$	-	19.4	-	ns	$V_{DD}=300V, I_D=10A, V_{GS}=10V, R_G=9.1\Omega$
* t_r	-	14.4	-		
* $t_{d(OFF)}$	-	75.8	-		
* t_f	-	18	-		
C_{iss}	-	1599	-	pF	$V_{GS}=0V, V_{DS}=25V, f=1MHz$
C_{oss}	-	159	-		
C_{rss}	-	26	-		
Source-Drain Diode					
* V_{SD}	-	-	1.5	V	$I_S=10A, V_{GS}=0V$
* I_S	-	-	10	A	
* I_{SM}	-	-	40		
* t_{rr}	-	424	636	ns	$V_{GS}=0V, I_F=10A, dI_F/dt=100A/\mu s$
* Q_{rr}	-	3.2	4.8	μC	

*Pulse Test : Pulse Width ≤300μs, Duty Cycle≤2%

Typical Characteristics

Typical Output Characteristics

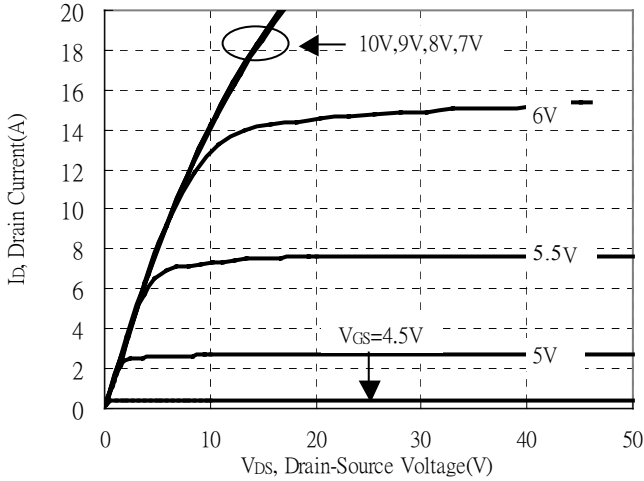

Static Drain-Source On-resistance vs Ambient Temperature

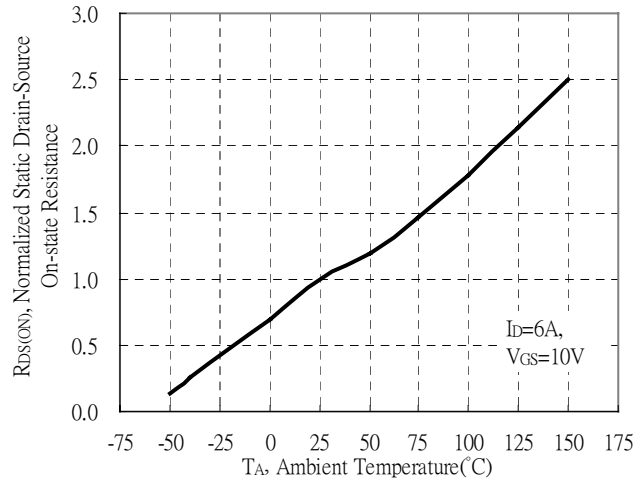

Static Drain-Source On-State resistance vs Drain Current

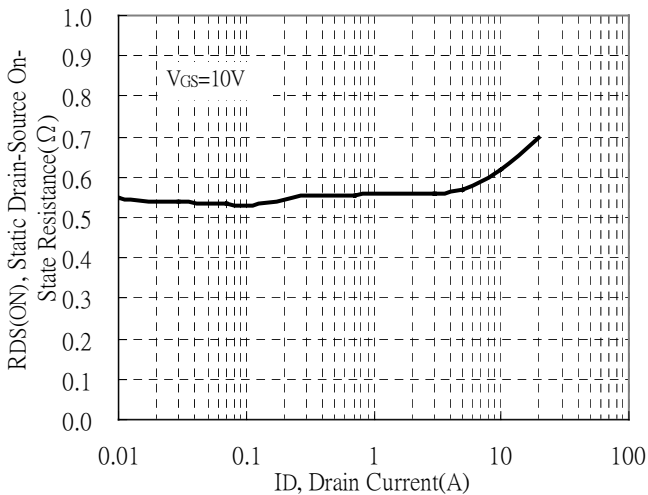

Drain Current vs Gate-Source Voltage

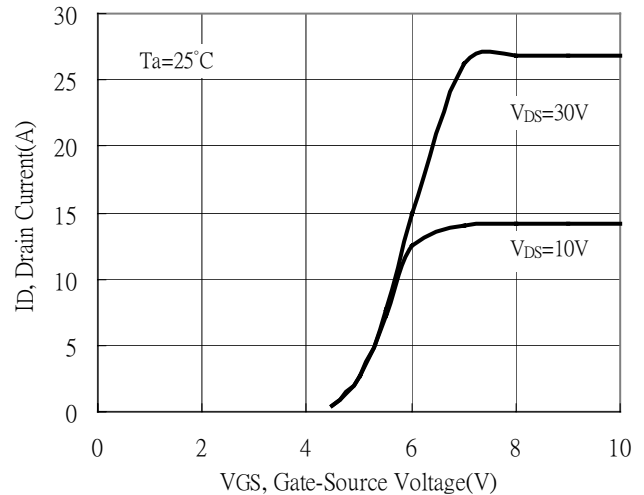

Static Drain-Source On-State Resistance vs Gate-Source Voltage

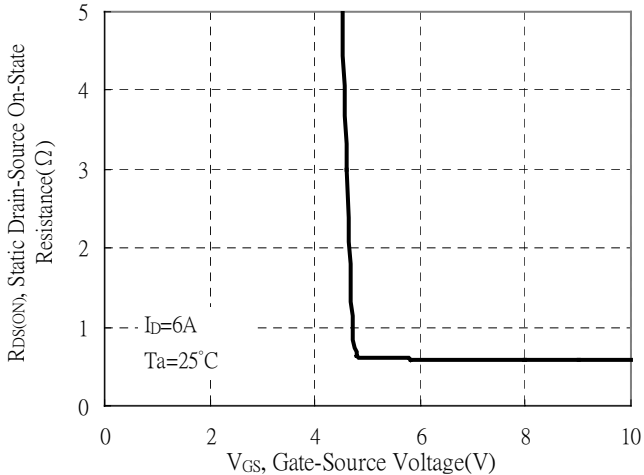

Forward Drain Current vs Source-Drain Voltage

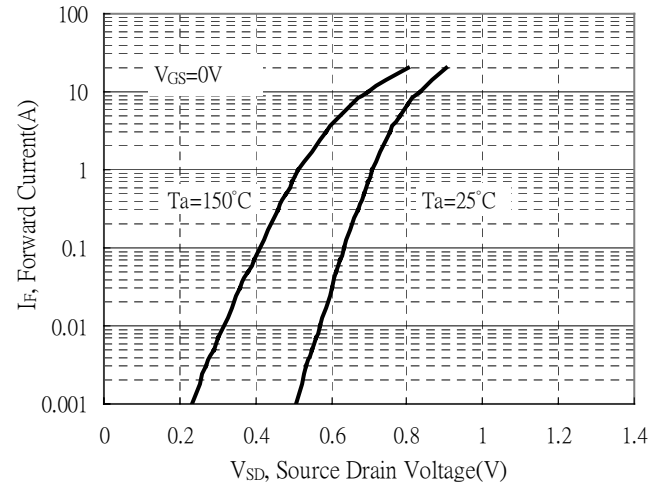

Typical Characteristics(Cont.)

Capacitance vs Reverse Voltage

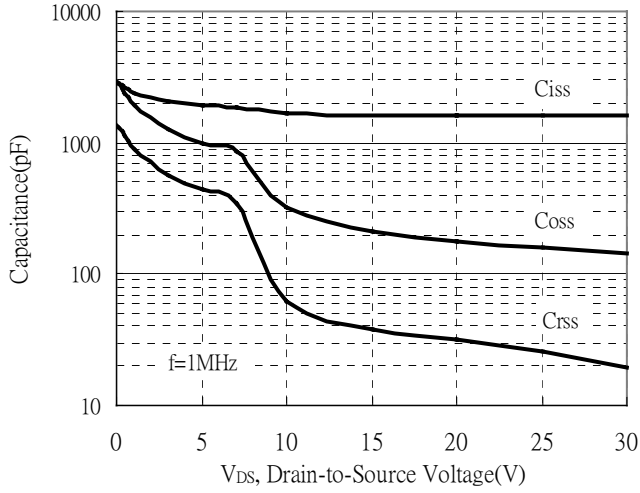

Brekdown Voltage vs Ambient Temperature

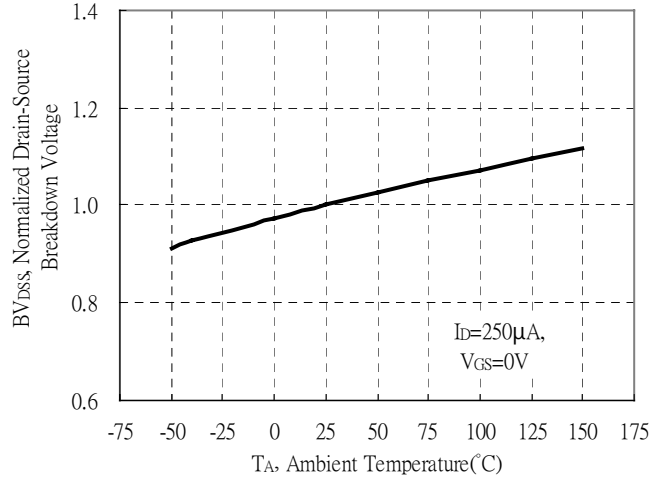

Maximum Safe Operating Area

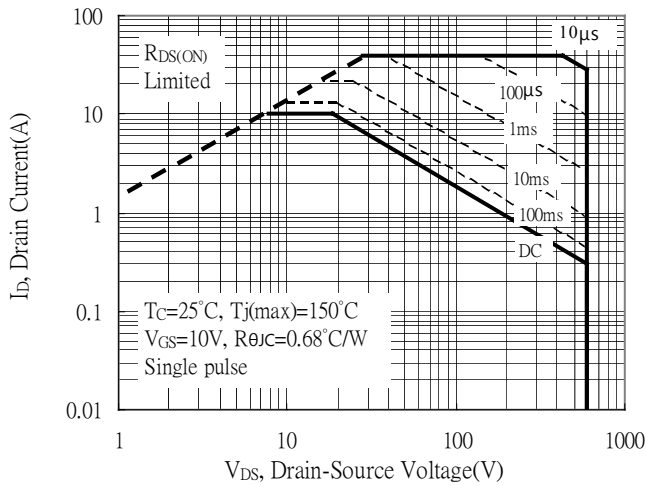

Gate Charge Characteristics

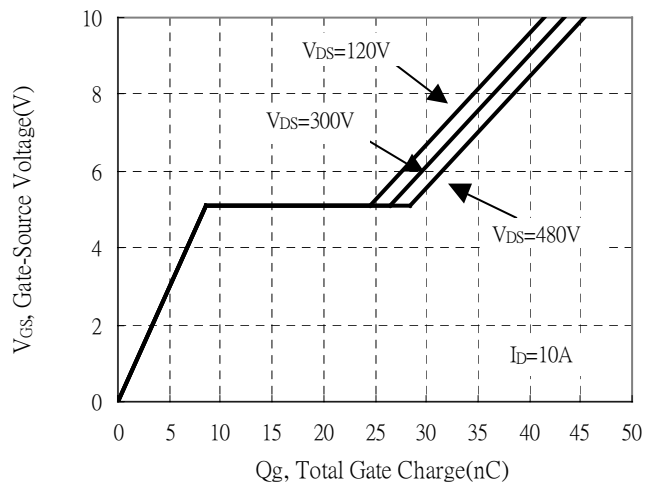

Maximum Drain Current vs Case Temperature

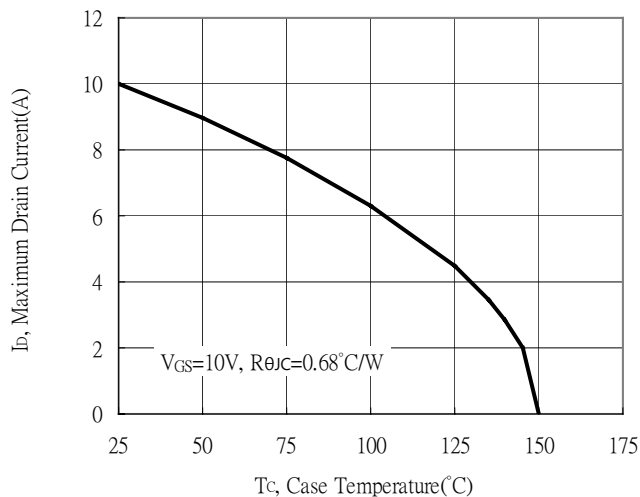

Threshold Voltage vs Junction Temperature

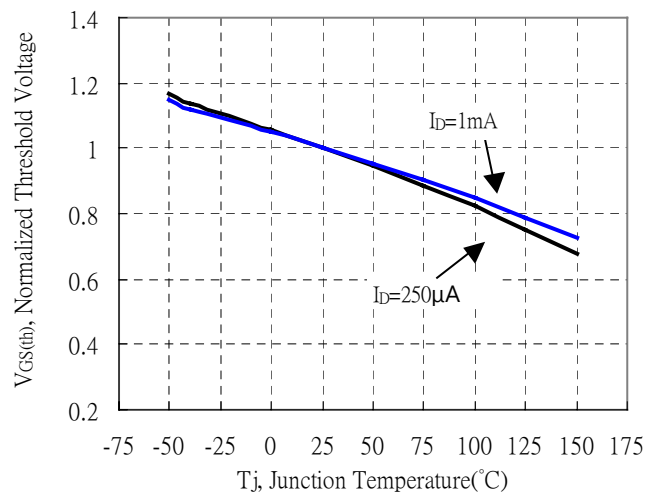

Typical Characteristics(Cont.)

Forward Transfer Admittance vs Drain Current

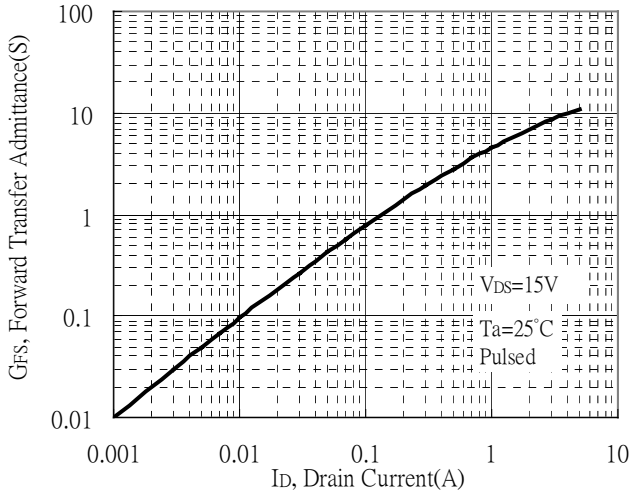

Single Pulse Power Rating, Junction to Case

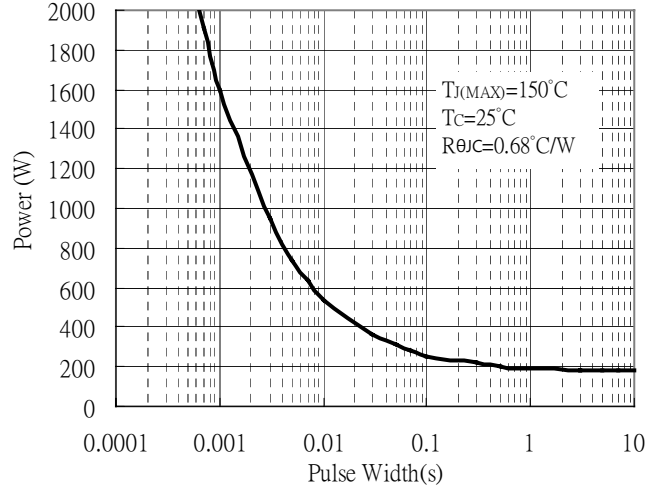

Transient Thermal Response Curves

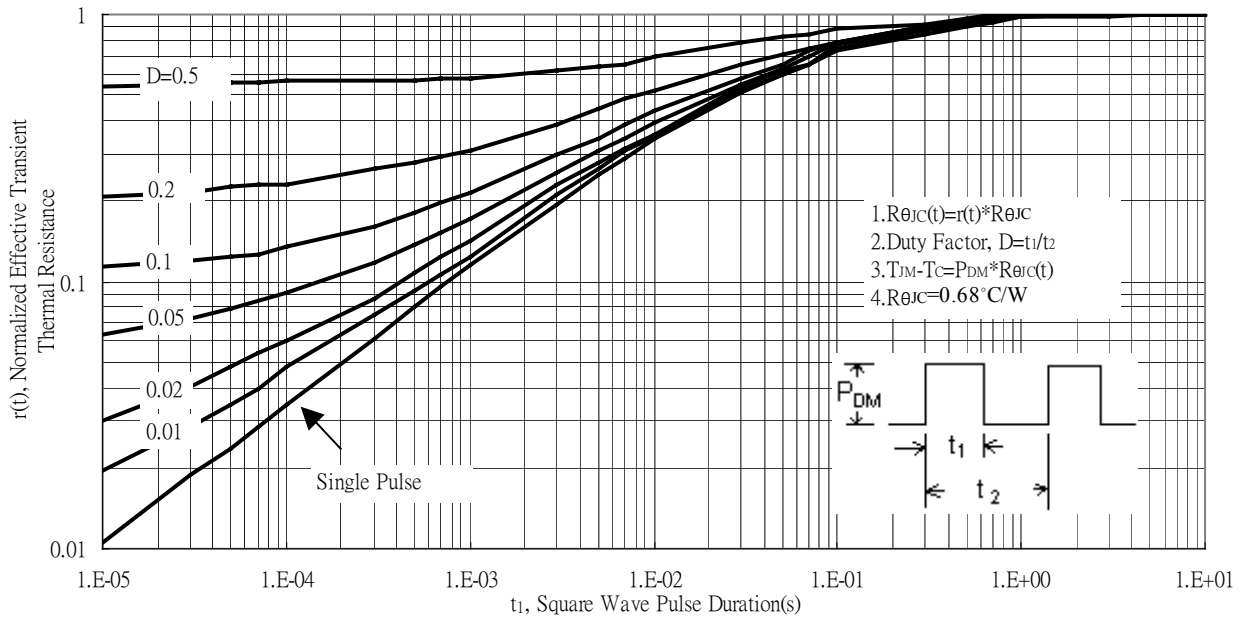

Test Circuit and Waveforms



Gate Charge Test Circuit

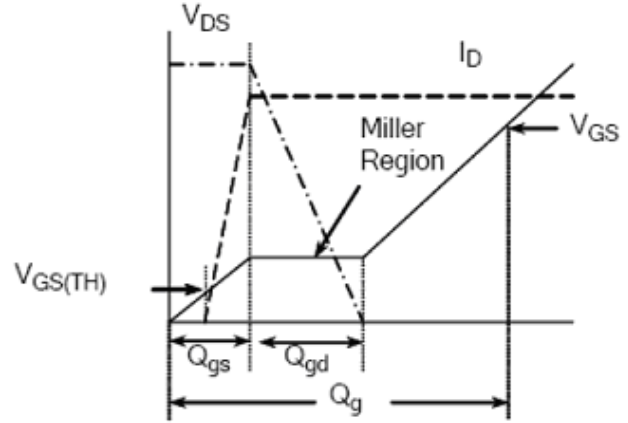

Gate Charge Waveform



Resistive Switching Test Circuit

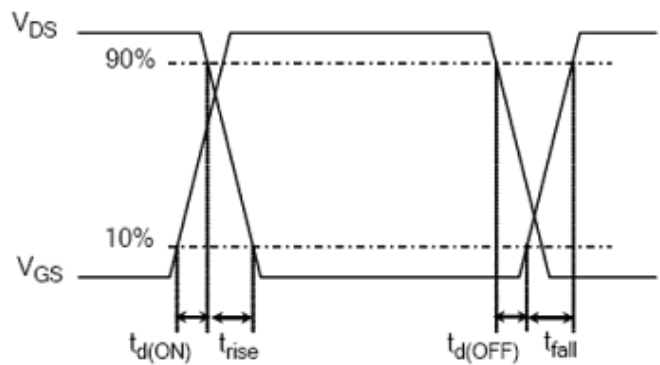

Resistive Switching Waveforms

Test Circuit and Waveforms(Cont.)



Diode Reverse Recovery Test Circuit

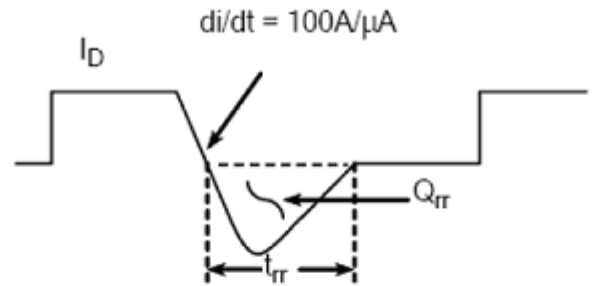

Diode Reverse Recovery Waveform

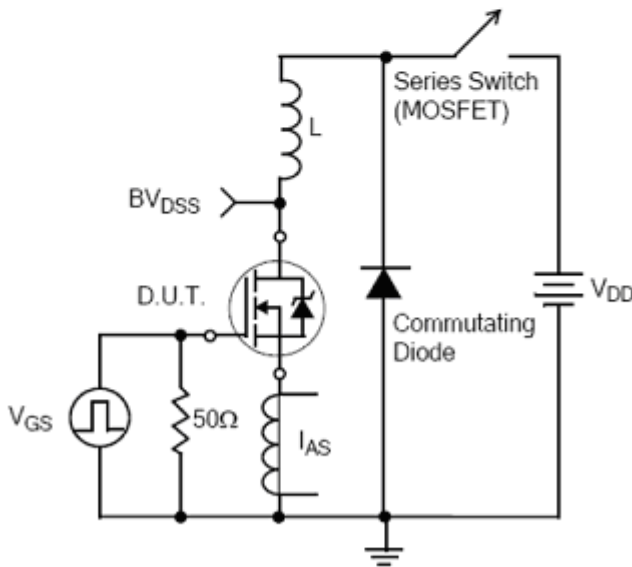

Unclamped Inductive Switching Test Circuit

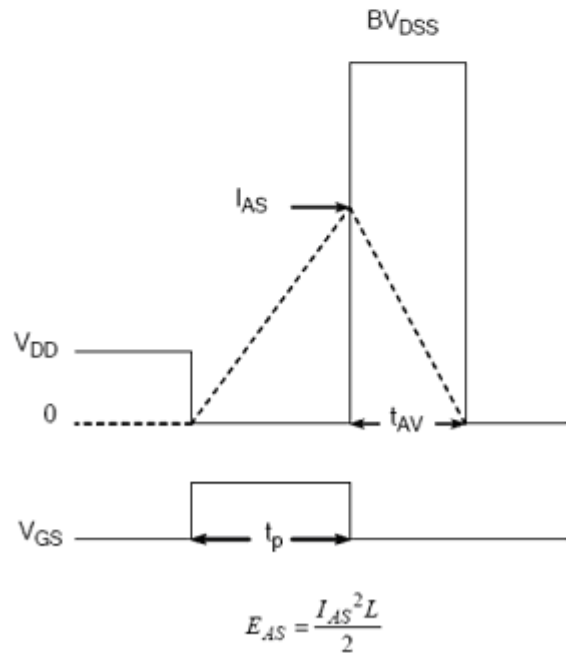

Unclamped Inductive Switching Waveforms

Recommended wave soldering condition

Product	Peak Temperature	Soldering Time
Pb-free devices	260 +0/-5 °C	5 +1/-1 seconds

Recommended temperature profile for IR reflow

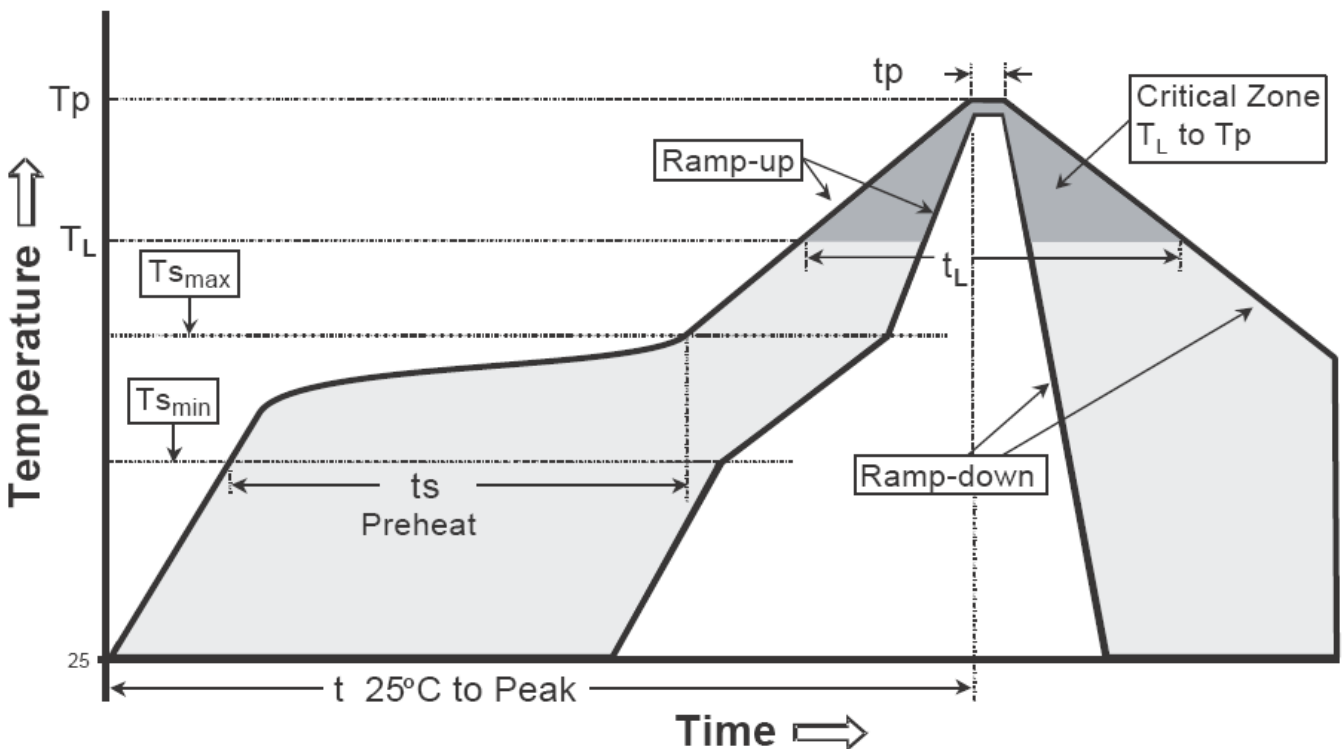

Profile feature	Sn-Pb eutectic Assembly	Pb-free Assembly
Average ramp-up rate (T _{smax} to T _p)	3°C/second max.	3°C/second max.
Preheat		
-Temperature Min(T _{s min})	100°C	150°C
-Temperature Max(T _{s max})	150°C	200°C
-Time(t _{s min} to t _{s max})	60-120 seconds	60-180 seconds
Time maintained above:		
-Temperature (T _L)	183°C	217°C
- Time (t _L)	60-150 seconds	60-150 seconds
Peak Temperature(T _P)	240 +0/-5 °C	260 +0/-5 °C
Time within 5°C of actual peak temperature(t _p)	10-30 seconds	20-40 seconds
Ramp down rate	6°C/second max.	6°C/second max.
Time 25 °C to peak temperature	6 minutes max.	8 minutes max.

Note : All temperatures refer to topside of the package, measured on the package body surface.

TO-220 Dimension

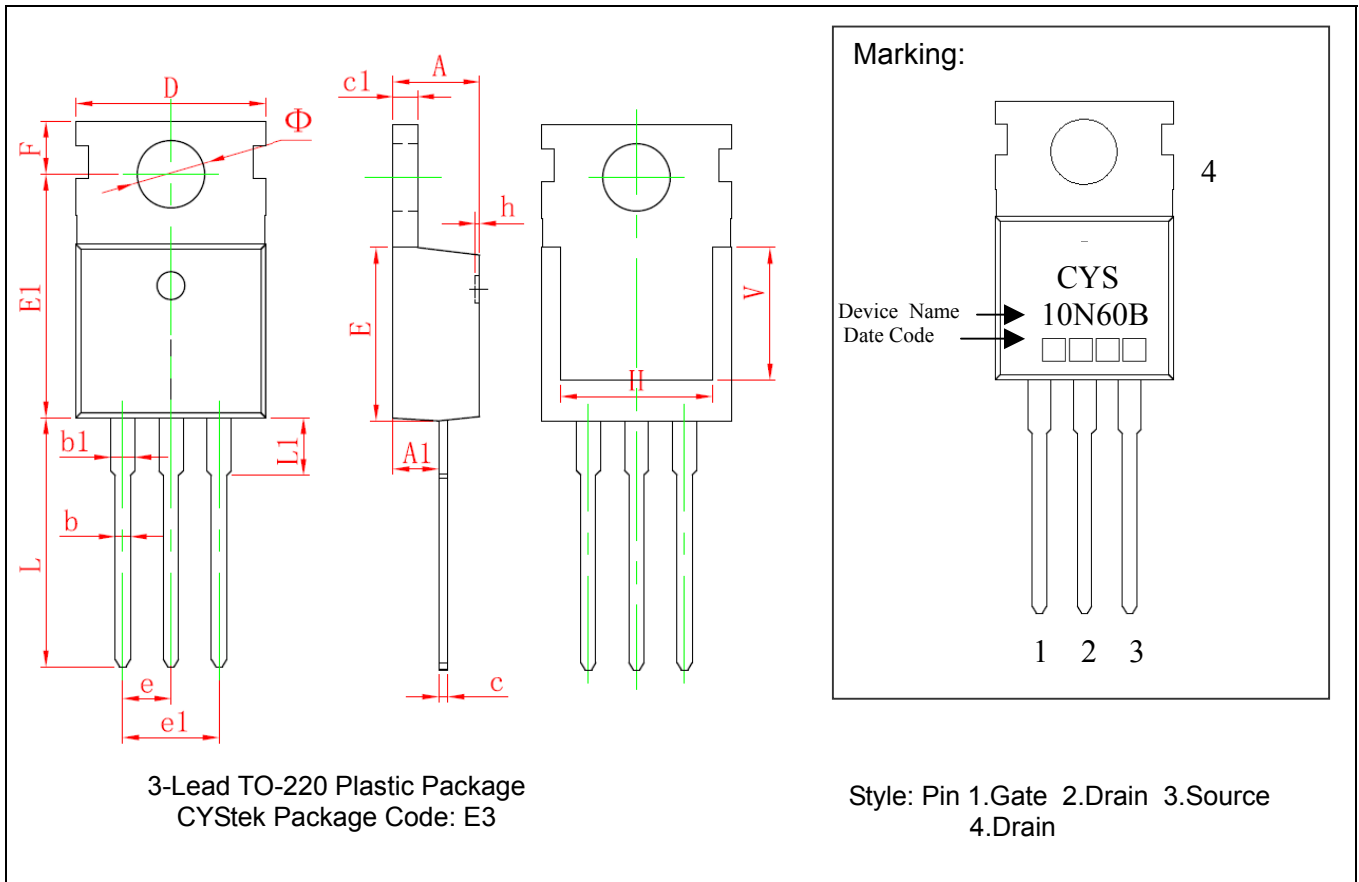

*: Typical

DIM	Millimeters		Inches		DIM	Millimeters		Inches	
	Min.	Max.	Min.	Max.		Min.	Max.	Min.	Max.
A	4.400	4.600	0.173	0.181	e	2.540*		0.100*	
A1	2.250	2.550	0.089	0.100	e1	4.980	5.180	0.196	0.204
b	0.710	0.910	0.028	0.036	F	2.650	2.950	0.104	0.116
b1	1.170	1.370	0.046	0.054	H	7.900	8.100	0.311	0.319
c	0.330	0.650	0.013	0.026	h	0.000	0.300	0.000	0.012
c1	1.200	1.400	0.047	0.055	L	12.900	13.400	0.508	0.528
D	9.910	10.250	0.390	0.404	L1	2.850	3.250	0.112	0.128
E	8.950	9.750	0.352	0.384	V	7/500	REF	0.295	REF
E1	12.650	12.950	0.498	0.510	Φ	3.400	3.800	0.134	0.150

Notes: 1.Controlling dimension: millimeters.
 2.Maximum lead thickness includes lead finish thickness, and minimum lead thickness is the minimum thickness of base material.
 3.If there is any question with packing specification or packing method, please contact your local CYStek sales office.

Material:

- Lead: Pure tin plated.
- Mold Compound: Epoxy resin family, flammability solid burning class: UL94V-0.

Important Notice:

- All rights are reserved. Reproduction in whole or in part is prohibited without the prior written approval of CYStek.
- CYStek reserves the right to make changes to its products without notice.
- CYStek **semiconductor products are not warranted to be suitable for use in Life-Support Applications, or systems.**
- CYStek assumes no liability for any consequence of customer product design, infringement of patents, or application assistance.