

Features

- Floating channel designed for bootstrap operation
- Fully operational to +600 V
- Tolerant to negative transient voltage, dV/dt immune
- Gate drive supply range from 10 V to 20 V
- Undervoltage lockout for both channels
- 3.3 V and 5 V input logic compatible
- Matched propagation delay for both channels
- Logic and power ground +/- 5 V offset
- Lower di/dt gate driver for better noise immunity
- Output source/sink current capability (min) 1.4 A/1.8 A
- Leadfree, RoHS compliant

Product Summary

Topology	High and Low Side Driver
V_{OFFSET}	≤ 600 V
V_{OUT}	10 V – 20 V
$I_{\text{o+}}$ & $I_{\text{o-}}$ (typical)	1.9 A & 2.3 A
t_{ON} & t_{OFF} (typical)	180 ns & 220 ns

Package Options



MLPQ4x4 16- Leads
(Without 2 leads)

Typical Connection

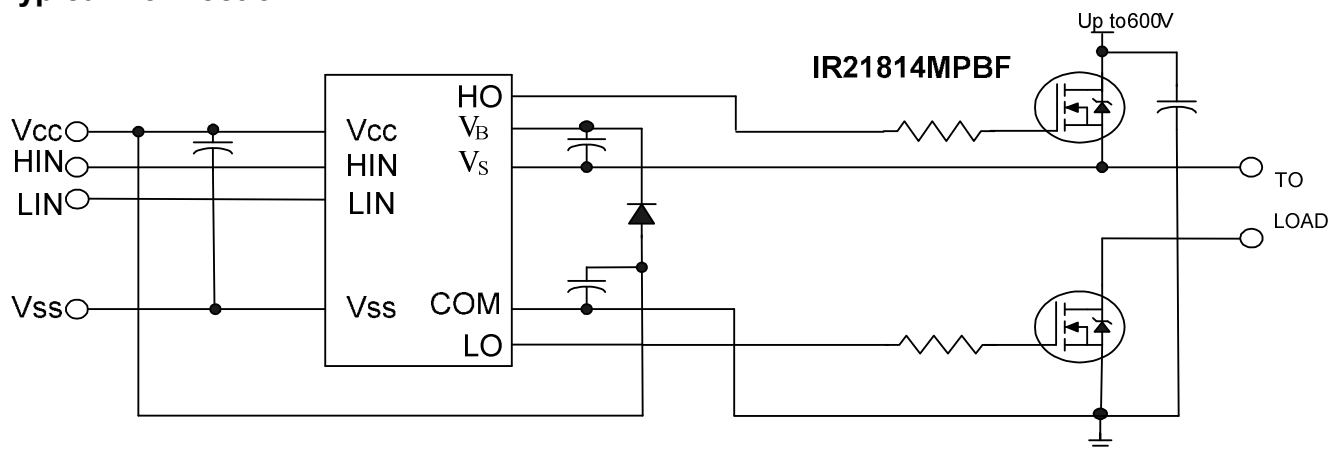

(Refer to Lead Assignments for correct pin configuration) This diagram shows electrical connections only. Please refer to our Application Notes and Design Tips for proper circuit board layout.

Description

The IRS21814MPBF is a high voltage, high speed power MOSFET and IGBT drivers with independent high- and low-side referenced output channels. Proprietary HVIC and latch immune CMOS technologies enable ruggedized monolithic construction. The logic input is compatible with standard CMOS or LSTTL output, down to 3.3 V logic. The output drivers feature a high pulse current buffer stage designed for minimum driver cross-conduction. The floating channel can be used to drive an N-channel power MOSFET or IGBT in the high-side configuration which operates up to 600 V.

Feature Comparison: IRS2181(4)/IRS2183(4)/IRS2184(4)

Part	Input Logic	Cross-Conduction Prevention logic	Dead-Time	Ground Pins	Ton/Toff
2181	HIN/LIN	no	none	COM	180/220 ns
21814				V _{SS} /COM	
2183	HIN/LIN	yes	Internal 500ns	COM	180/220 ns
21834			Programmable 0.4 – 5 us	V _{SS} /COM	
2184	IN/SD	yes	Internal 500ns	COM	680/270 ns
21844			Programmable 0.4 – 5 us	V _{SS} /COM	

Qualification Information[†]

Qualification Level		Industrial ^{††} (per JEDEC JESD 47) Comments: This IC has passed JEDEC's Industrial qualification. IR's Consumer qualification level is granted by extension of the higher Industrial level.
Moisture Sensitivity Level		MLPQ4x4 14L MSL2 ^{†††} (per IPC/JEDEC J-STD-020)
ESD	Machine Model	Class A (+/-150V) (per JEDEC standard JESD22-A115)
	Human Body Model	Class 1B (+/-1000V) (per EIA/JEDEC standard EIA/JESD22-A114)
	Charged Device Model	Class III (+/-1000V) (per JEDEC standard JESD22-C101)
IC Latch-Up Test		Class II, Level A (per JESD78A)
RoHS Compliant		Yes

† Qualification standards can be found at International Rectifier's web site <http://www.irf.com/>

†† Higher qualification ratings may be available should the user have such requirements. Please contact your International Rectifier sales representative for further information.

††† Higher MSL ratings may be available for the specific package types listed here. Please contact your International Rectifier sales representative for further information.

Absolute Maximum Ratings

Absolute Maximum Ratings indicate sustained limits beyond which damage to the device may occur. All voltage parameters are absolute voltages referenced to COM. The thermal resistance and power dissipation ratings are measured under board mounted and still air conditions.

Symbol	Definition	Min	Max	Units
V_B	High-side floating absolute voltage	-0.3	625	V
V_S	High-side floating supply offset voltage	$V_B - 25$	$V_B + 0.3$	
V_{HO}	High-side floating output voltage	$V_S - 0.3$	$V_B + 0.3$	
V_{CC}	Low-side and logic fixed supply voltage	-0.3	20 †	
V_{LO}	Low-side output voltage	-0.3	$V_{CC} + 0.3$	
V_{IN}	Logic input voltage (HIN & LIN)	$V_{SS} - 0.3$	$V_{CC} + 0.3$	
V_{SS}	Logic ground	$V_{CC} - 20$	$V_{CC} + 0.3$	
dV_S/dt	Allowable offset supply voltage transient	—	50	V/ns
P_D	Package power dissipation @ $T_A \leq 25^\circ\text{C}$	—	2.08	W
R_{thJA}	Thermal resistance, junction to ambient	—	36	$^\circ\text{C}/\text{W}$
T_J	Junction temperature	—	150	$^\circ\text{C}$
T_S	Storage temperature	-50	150	
T_L	Lead temperature (soldering, 10 seconds)	—	300	

† All supplies are fully tested at 25 V and an internal 20 V clamp exists for each supply

Recommended Operating Conditions

The input/output logic timing diagram is shown in figure 1. For proper operation the device should be used within the recommended conditions. The V_S and V_{SS} offset rating are tested with all supplies biased at 15 V differential.

Symbol	Definition	Min	Max	Units
V_B	High-side floating supply absolute voltage	$V_S + 10$	$V_S + 20$	V
V_S	High-side floating supply offset voltage	††	600	
V_{HO}	High-side floating output voltage	V_S	V_B	
V_{CC}	Low-side and logic fixed supply voltage	10	20	
V_{LO}	Low-side output voltage	0	V_{CC}	
V_{IN}	Logic input voltage	V_{SS}	V_{CC}	
V_{SS}	Logic ground	-5	5	
T_A	Ambient temperature	-40	125	$^\circ\text{C}$

†† Logic operational for V_S of -5 V to +600 V. Logic state held for V_S of -5 V to $-V_{BS}$. (Please refer to the Design Tip DT97-3 for more details).

Dynamic Electrical Characteristics

$V_{BIAS} (V_{CC}, V_{BS}) = 15\text{ V}$, $V_{SS} = \text{COM}$, $C_L = 1000\text{ pF}$, $T_A = 25^\circ\text{C}$ unless otherwise specified.

Symbol	Definition	Min	Typ	Max	Units	Test Conditions
t_{on}	Turn-on propagation delay	—	180	270	ns	$V_S = 0\text{ V}$
t_{off}	Turn-off propagation delay	—	220	330		$V_S = 0\text{ V}$ or 600 V
MT	Delay matching, HS & LS turn-on/off	—	—	35		
t_r	Turn-on rise time	—	40	60		
t_f	Turn-off fall time	—	20	35		$V_S = 0\text{ V}$

Static Electrical Characteristics

$V_{BIAS} (V_{CC}, V_{BS}) = 15\text{ V}$, $V_{SS} = \text{COM}$, $T_A = 25^\circ\text{C}$ unless otherwise specified. The V_{IL} , V_{IH} and I_{IN} parameters are referenced to V_{SS}/COM and are applicable to the respective input leads: HIN and LIN. The V_O , I_O and R_{on} parameters are referenced to COM and are applicable to the respective output leads: HO and LO.

Symbol	Definition	Min	Typ	Max	Units	Test Conditions
V_{IH}	Logic "1" input voltage	2.5	—	—	V	$V_{CC} = 10\text{ V}$ to 20 V
V_{IL}	Logic "0" input voltage	—	—	0.8		$V_{CC} = 10\text{ V}$ to 20 V
V_{OH}	High level output voltage, $V_{BIAS} - V_O$	—	—	1.4		$I_O = 0\text{ mA}$
V_{OL}	Low level output voltage, V_O	—	—	0.2		$I_O = 20\text{ mA}$
I_{LK}	Offset supply leakage current	—	—	50	μA	$V_B = V_S = 600\text{ V}$
I_{QBS}	Quiescent V_{BS} supply current	20	60	150		$V_{IN} = 0\text{ V}$ or 5 V
I_{QCC}	Quiescent V_{CC} supply current	50	120	240		$V_{IN} = 5\text{ V}$
I_{IN+}	Logic "1" input bias current	—	25	60		$V_{IN} = 0\text{ V}$
I_{IN-}	Logic "0" input bias current	—	—	1.0		
V_{CCUV+} V_{BSUV+}	V_{CC} and V_{BS} supply undervoltage positive going threshold	8.0	8.9	9.8	V	
V_{CCUV-} V_{BSUV-}	V_{CC} and V_{BS} supply undervoltage negative going threshold	7.4	8.2	9.0		
V_{CCUVH} V_{BSUVH}	V_{CC} and V_{BS} supply undervoltage Hysteresis	0.3	0.7	—		
I_{O+}	Output high short circuit pulsed current	1.4	1.9	—	mA	$V_O = 0\text{ V}$, $PW \leq 10\text{ }\mu\text{s}$
I_{O-}	Output low short circuit pulsed current	1.8	2.3	—		$V_O = 15\text{ V}$, $PW \leq 10\text{ }\mu\text{s}$

Functional Block Diagrams: IRS21814

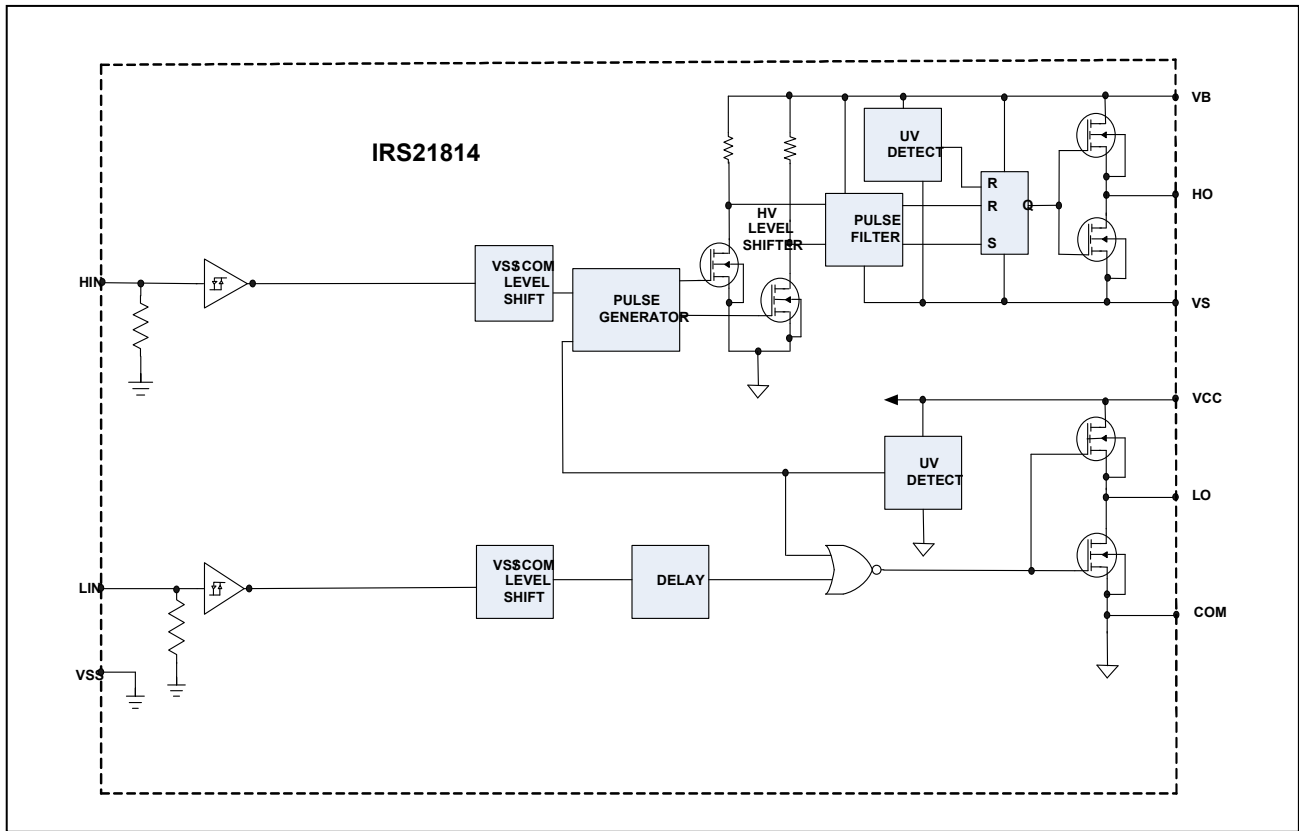

Input/Output Pin Equivalent Circuit Diagrams: IRS21814

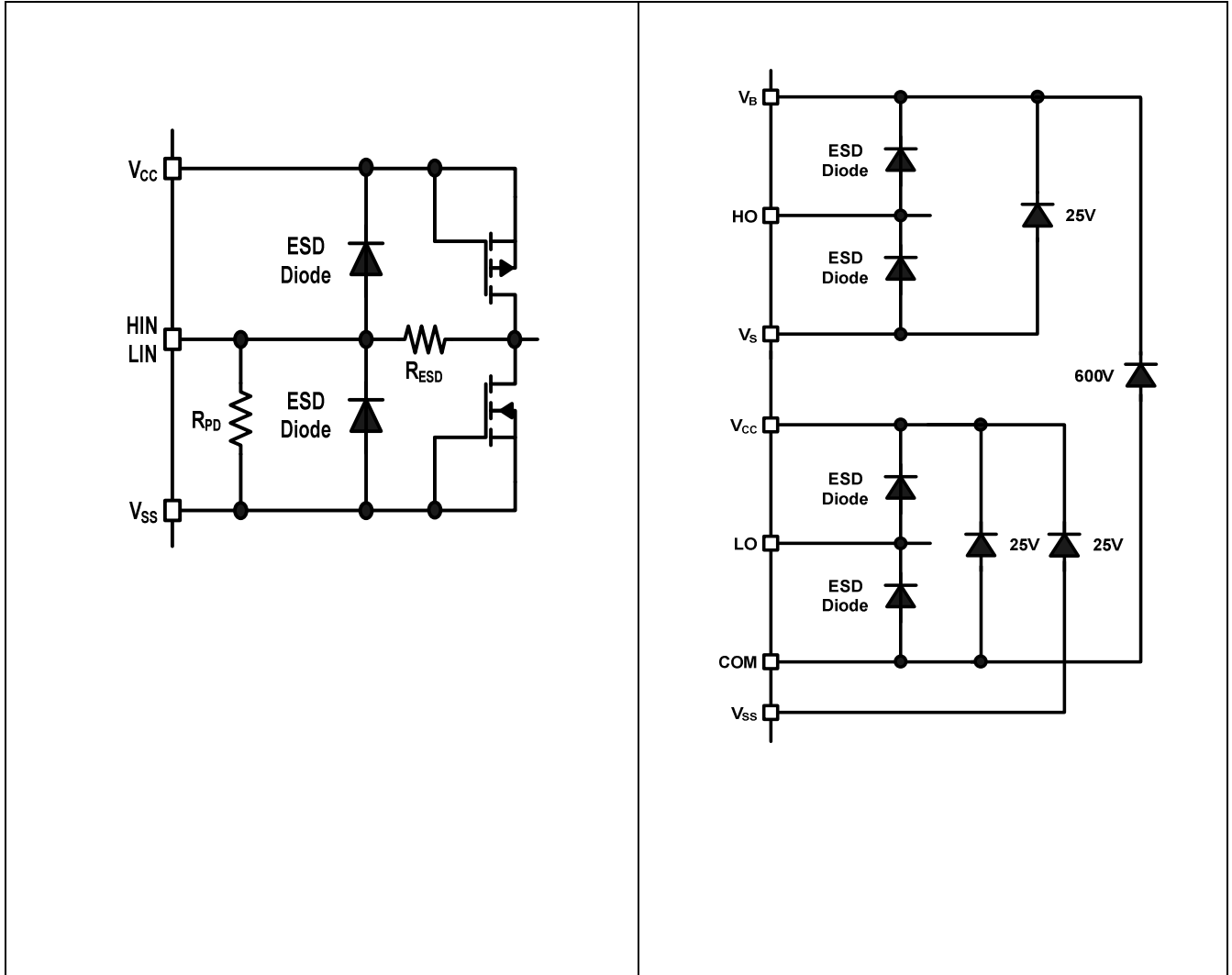

Lead Definitions: IRS21814MPBF

PIN	Symbol	Description
1	LIN	Logic input for low-side driver output (LO), in phase
2	V _{SS}	Logic ground
3	NC	No Connection
4	COM	Low-side return
5	LO	Low-side gate drive output
6	NC	No Connection
7	V _{CC}	Low-side and logic fixed supply
8	NC	No Connection
9	NC	No Connection
10	NC	No Connection (removed lead)
11	V _S	High-side floating supply return
12	HO	High-side gate drive output
13	V _B	High-side floating supply
14	NC	No Connection
15	NC	No Connection (removed lead)
16	HIN	Logic input for high-side gate driver output (HO), in phase

Lead Assignments:

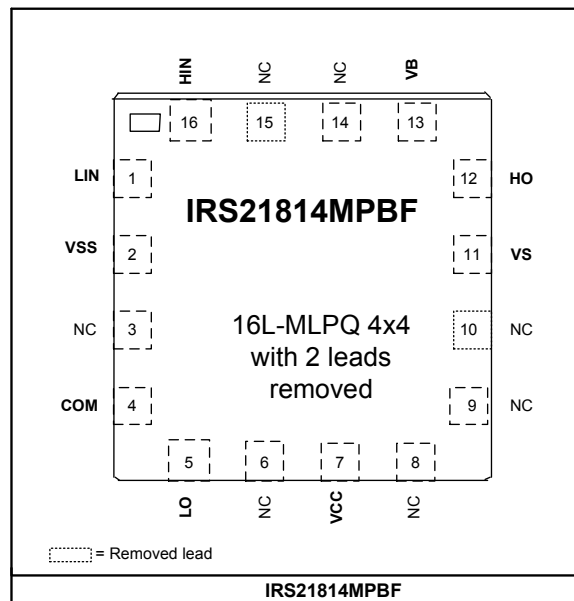

Application Information and Additional Details

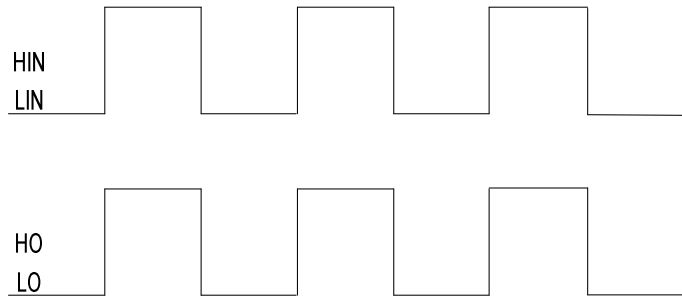

Figure 1. Input/Output Timing Diagram

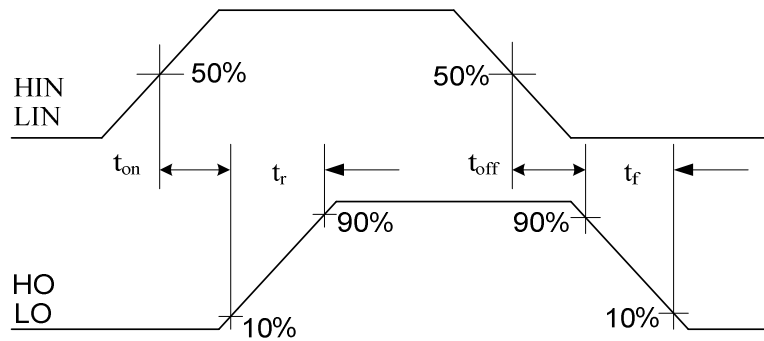

Figure 2. Switching Time Waveform Definitions

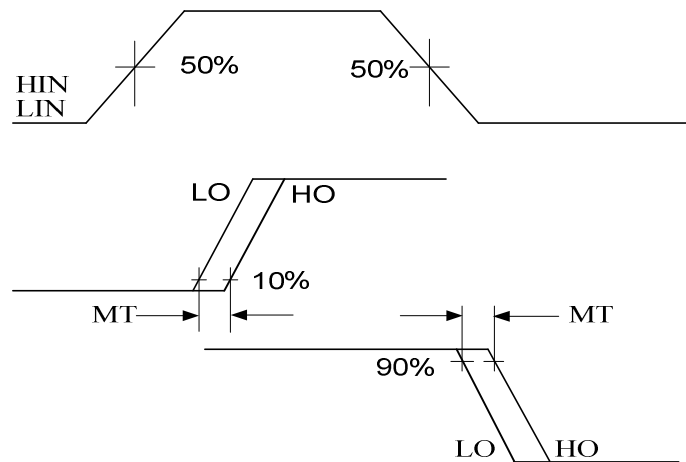

Figure 3. Delay Matching Waveform Definitions

Parameter Temperature Trends

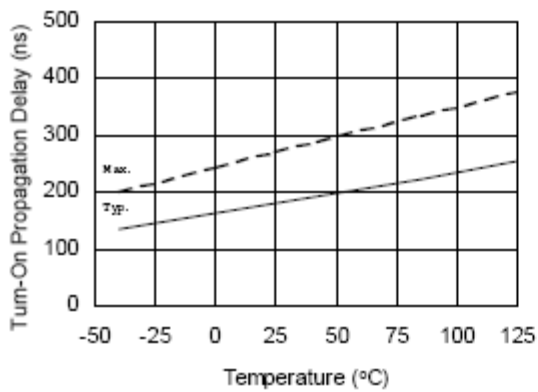

Figure 4A. Turn-On Propagation Delay vs. Temperature

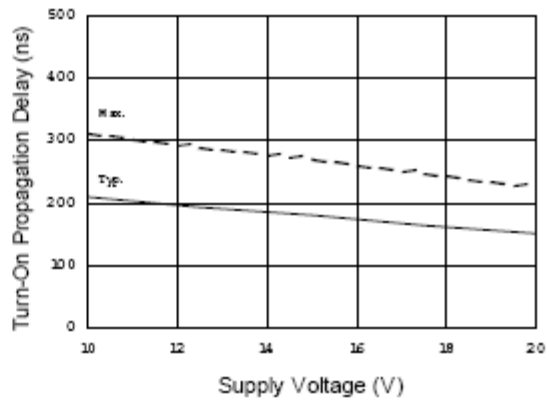

Figure 4B. Turn-On Propagation Delay vs. Supply Voltage

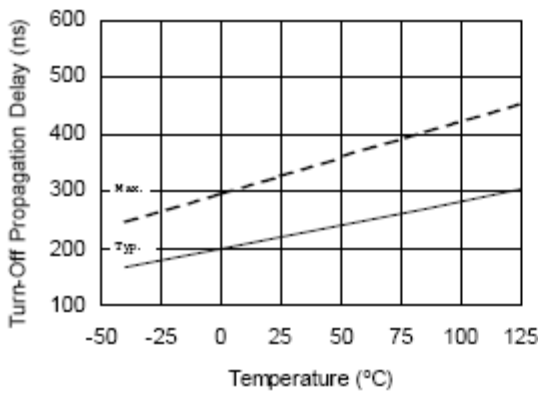

Figure 5A. Turn-Off Propagation Delay vs. Temperature

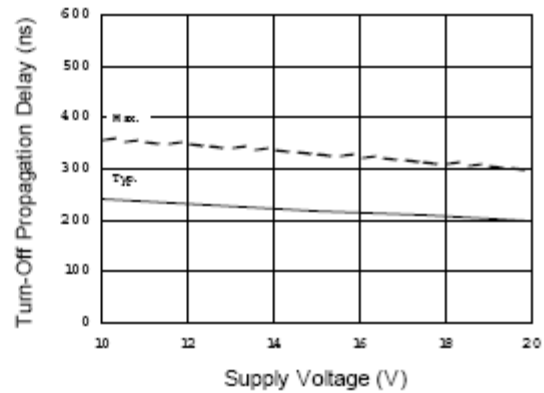

Figure 5B. Turn-Off Propagation Delay vs. Supply Voltage

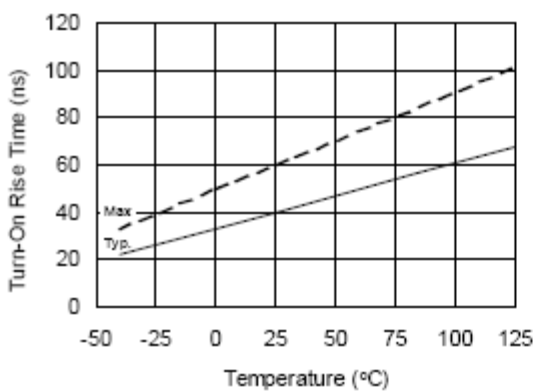

Figure 6A. Turn-On Rise Time vs. Temperature

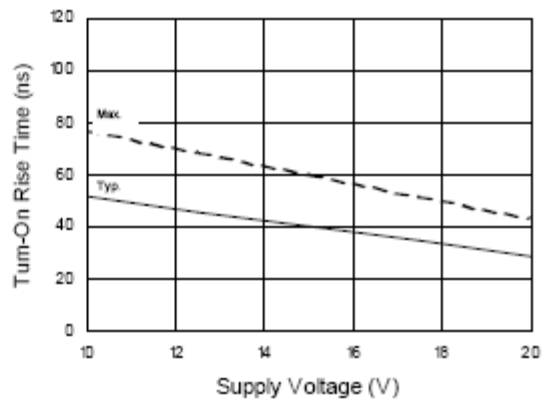

Figure 6B. Turn-On Rise Time vs. Supply Voltage

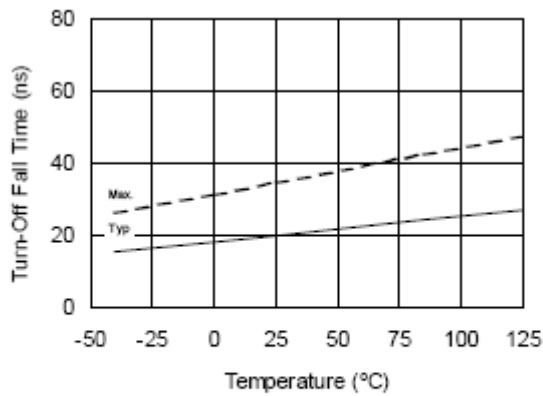

Figure 7A. Turn-Off Fall Time vs. Temperature

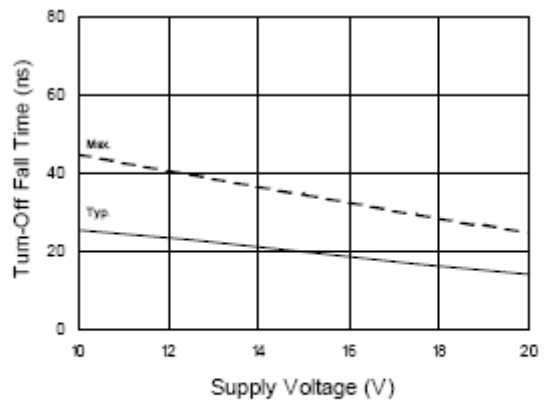

Figure 7B. Turn-Off Fall Time vs. Supply Voltage

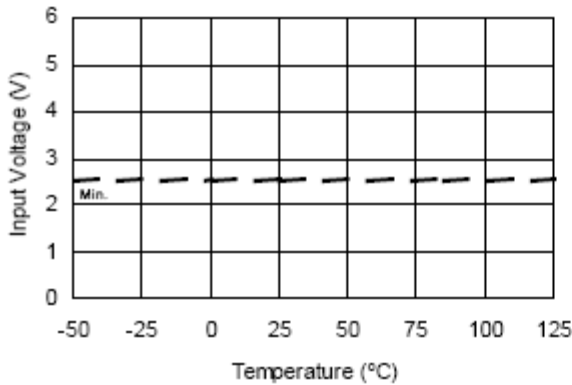

Figure 8A. Logic "1" Input Voltage vs. Temperature

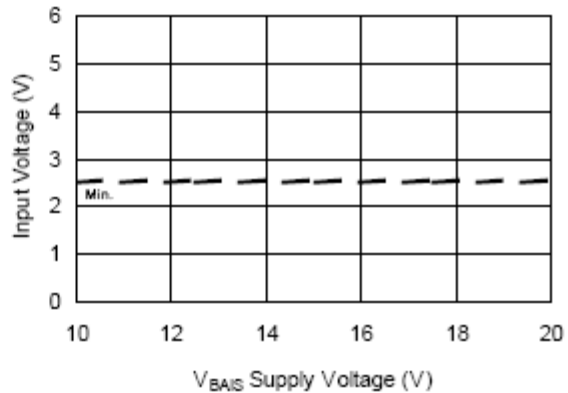

Figure 8B. Logic "1" Input Voltage vs. Supply Voltage

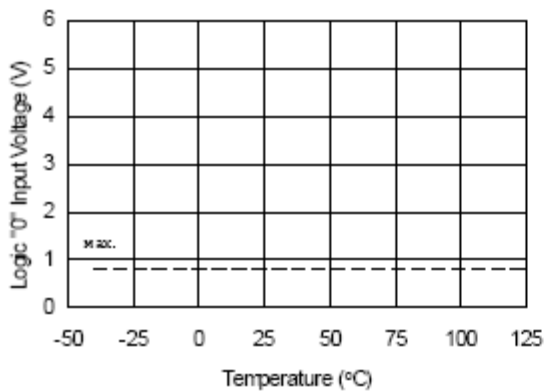

Figure 9A. Logic "0" Input Voltage vs. Temperature

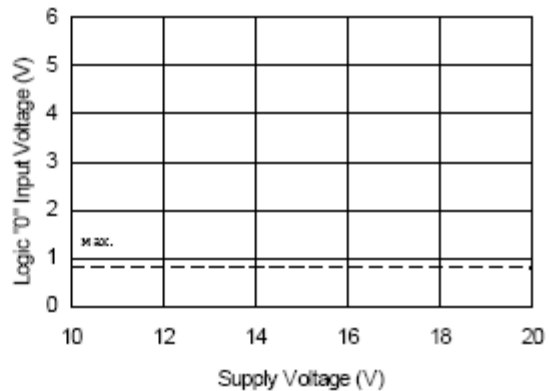

Figure 9B. Logic "0" Input Voltage vs. Supply Voltage

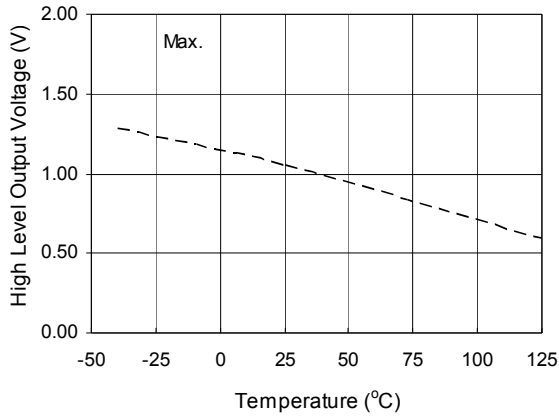

Figure 10A. High Level Output Voltage vs. Temperature ($I_O = 0$ mA)

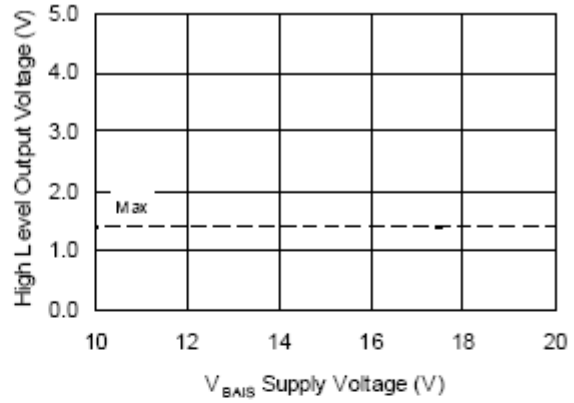

Figure 10B. High Level Output Voltage vs. Supply Voltage ($I_O = 0$ mA)

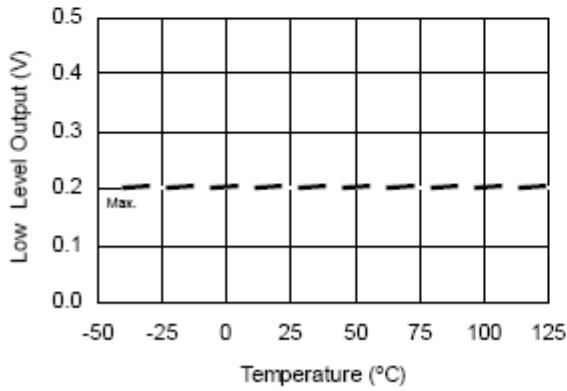

Figure 11A. Low Level Output vs. Temperature

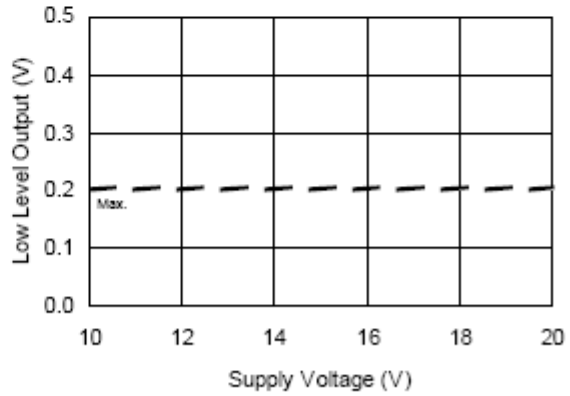

Figure 11B. Low Level Output vs. Supply Voltage

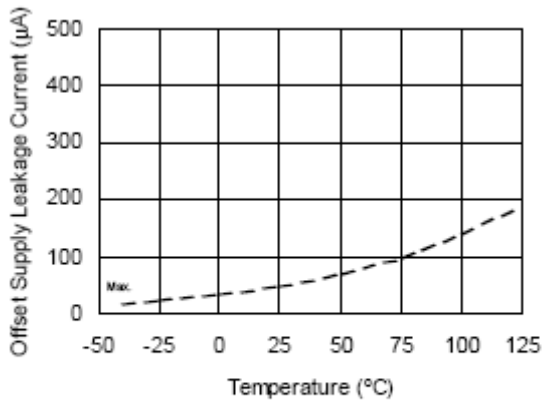

Figure 12A. Offset Supply Leakage Current vs. Temperature

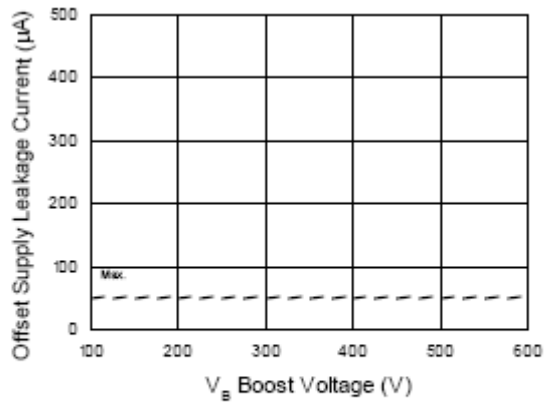

Figure 12B. Offset Supply Leakage Current vs. V_B Boost Voltage

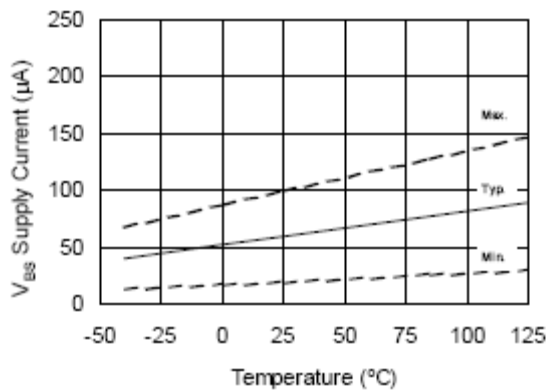

Figure 13A. V_{BS} Supply Current vs. Temperature

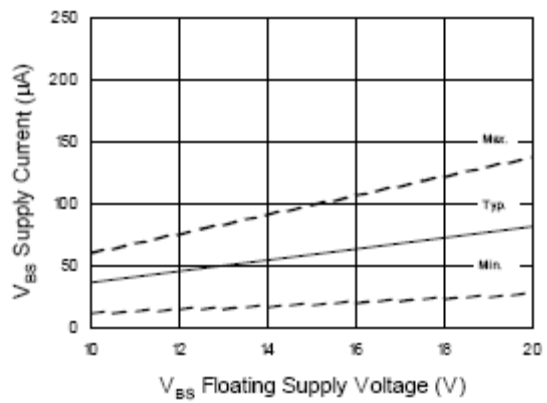

Figure 13B. V_{BS} Supply Current vs. V_{BS} Floating Supply Voltage

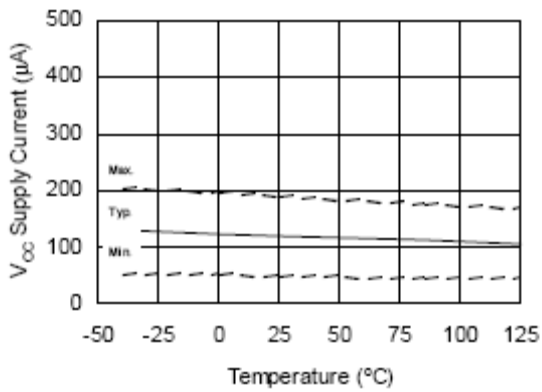

Figure 14A. V_{CC} Supply Current vs. V_{CC} Temperature

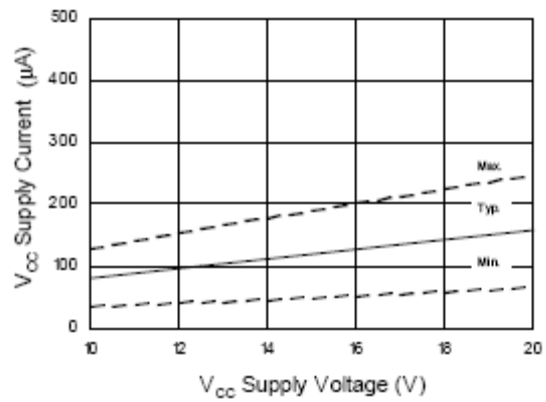

Figure 14B. V_{CC} Supply Current vs. V_{CC} Supply Voltage

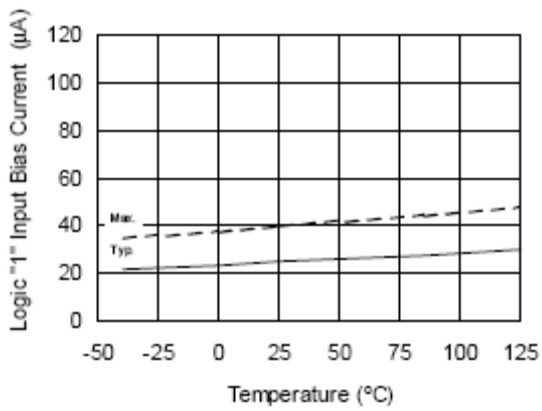

Figure 15A. Logic "1" Input Bias Current vs. Temperature

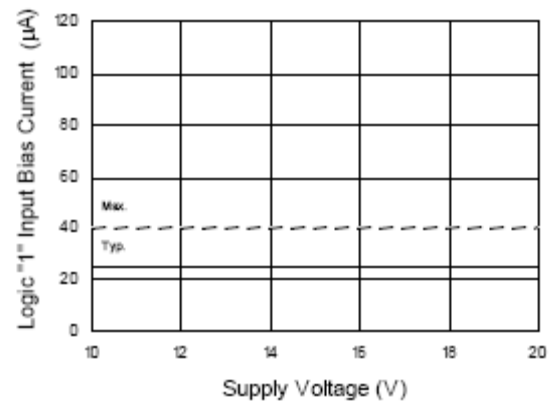

Figure 15B. Logic "1" Input Bias Current vs. Supply Voltage

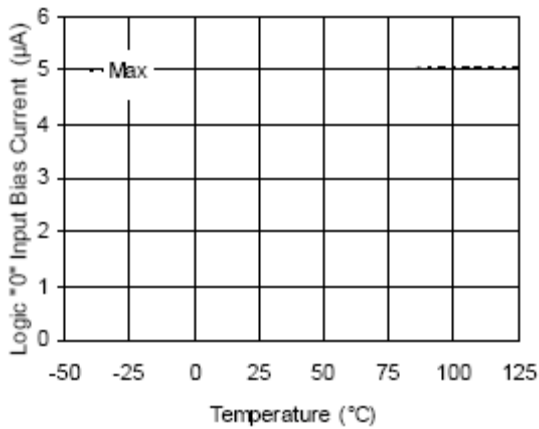

Figure 16A. Logic "0" Input Bias Current vs. Temperature

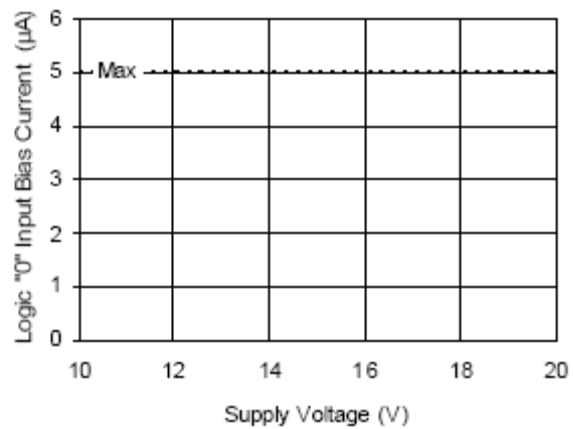

Figure 16B. Logic "0" Input Bias Current vs. Voltage

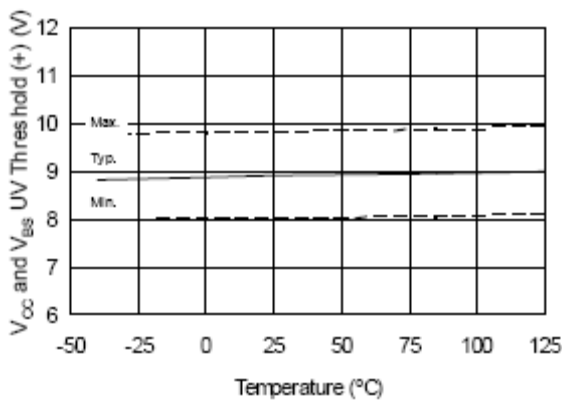

Figure 17. V_{CC} and V_{BS} Undervoltage Threshold (+) vs. Temperature

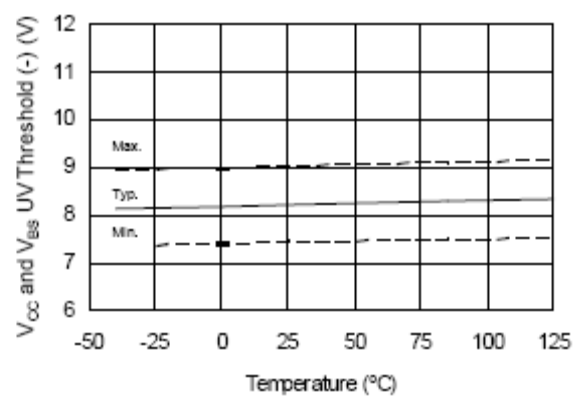

Figure 18. V_{CC} and V_{BS} Undervoltage Threshold (-) vs. Temperature

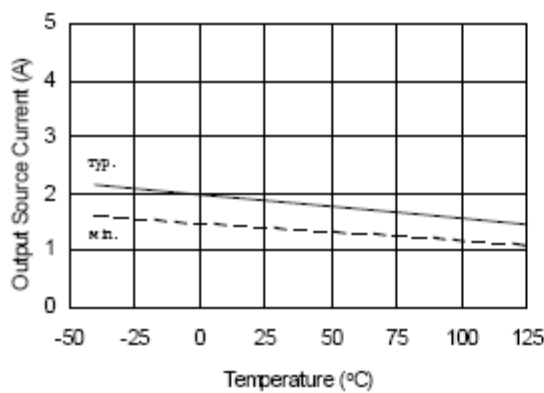

Figure 19A. Output Source Current vs. Temperature

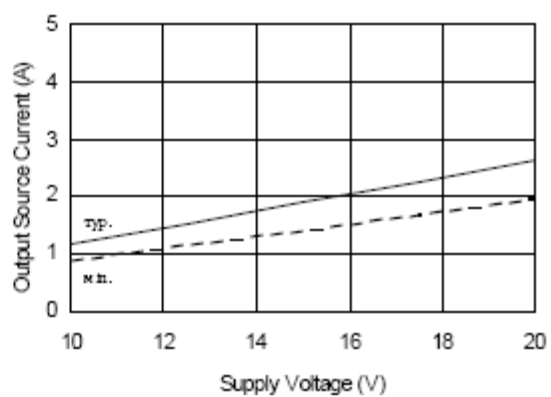

Figure 19B. Output Source Current vs. Supply Voltage

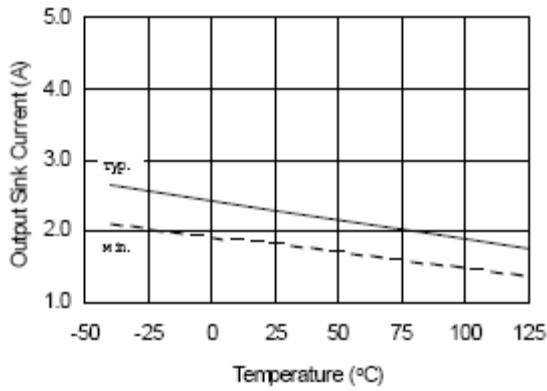

Figure 20A. Output Sink Current vs. Temperature

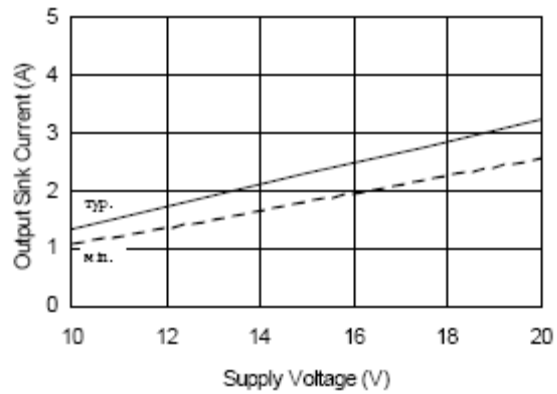

Figure 20B. Output Sink Current vs. Supply Voltage

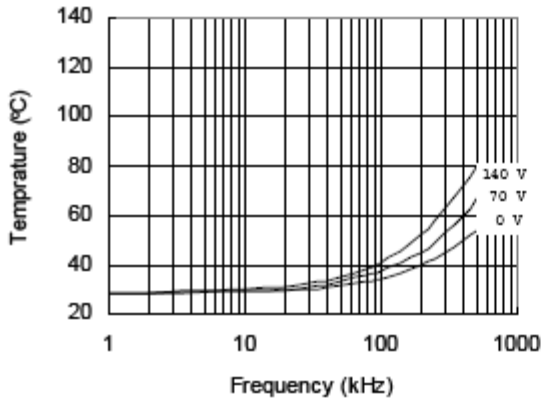

Figure 21. IRS2181 vs. Frequency (IRFBC20), $R_{gate}=33 \Omega$, $V_{CC}=15 V$

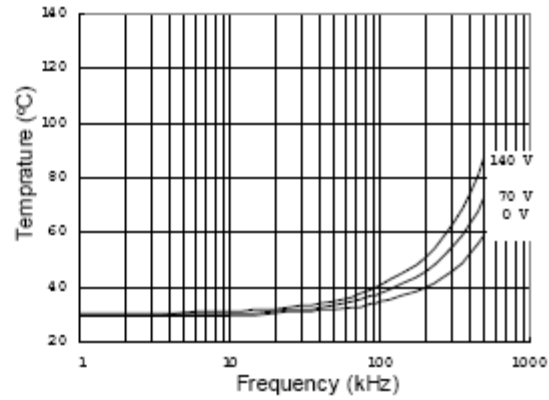

Figure 22. IRS2181 vs. Frequency (IRFBC30), $R_{gate}=22 \Omega$, $V_{CC}=15 V$

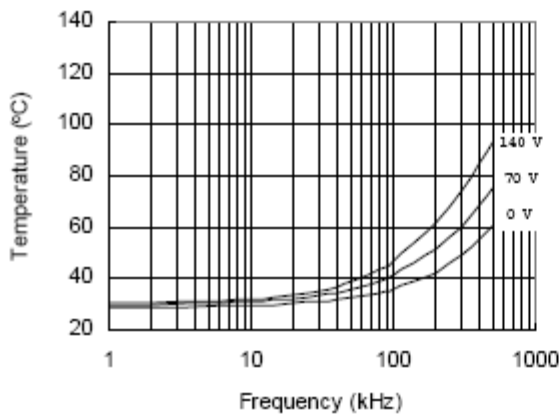

Figure 23. IRS2181 vs. Frequency (IRFBC40), $R_{gate}=15 \Omega$, $V_{CC}=15 V$

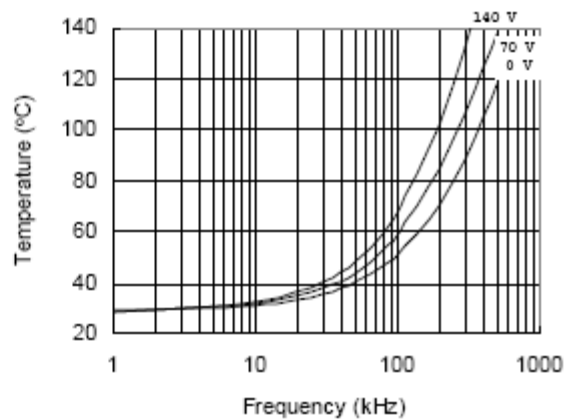

Figure 24. IRS2181 vs. Frequency (IRFPE50), $R_{gate}=10 \Omega$, $V_{CC}=15 V$

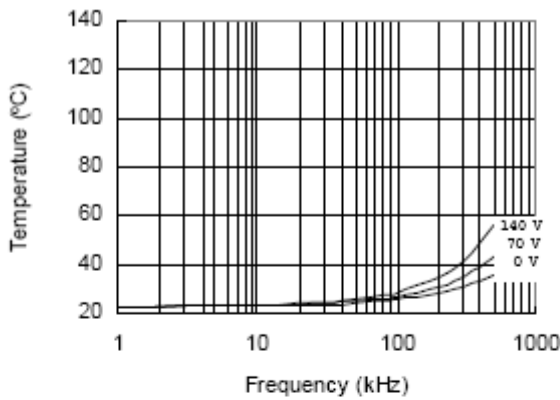

Figure 25. IRS21814 vs. Frequency (IRFBC20),
 $R_{gate}=33 \Omega$, $V_{CC}=15 V$

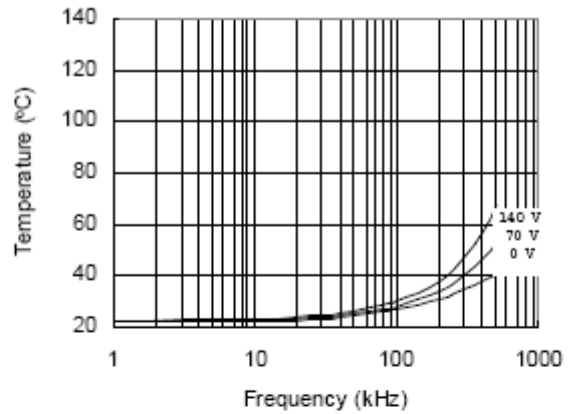

Figure 26. IRS21814 vs. Frequency (IRFBC30),
 $R_{gate}=22 \Omega$, $V_{CC}=15 V$

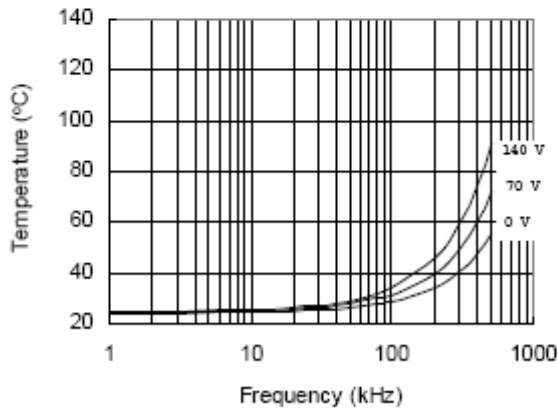

Figure 27. IRS21814 vs. Frequency (IRFBC40),
 $R_{gate}=15 \Omega$, $V_{CC}=15 V$

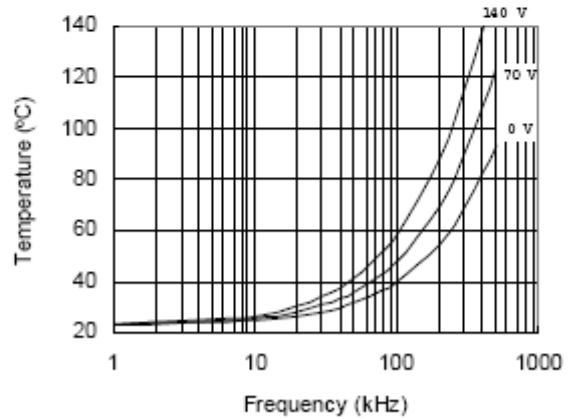

Figure 28. IRS21814 vs. Frequency (IRFPE50),
 $R_{gate}=10 \Omega$, $V_{CC}=15 V$

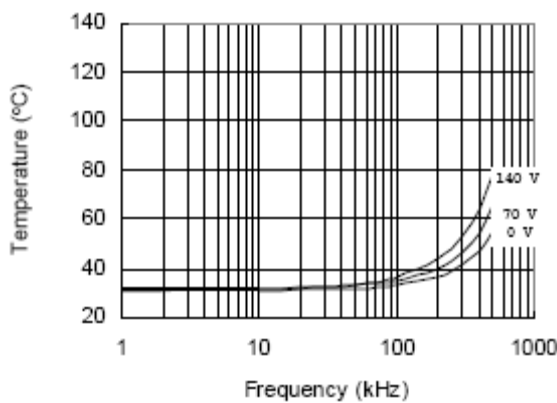

Figure 29. IRS2181S vs. Frequency (IRFBC20),
 $R_{gate}=33 \Omega$, $V_{CC}=15 V$

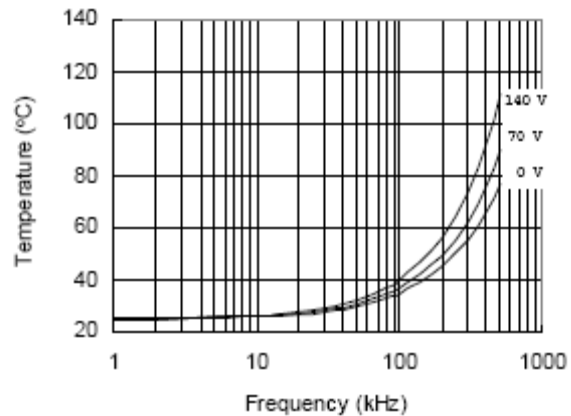

Figure 30. IRS2181S vs. Frequency (IRFBC30),
 $R_{gate}=22 \Omega$, $V_{CC}=15 V$

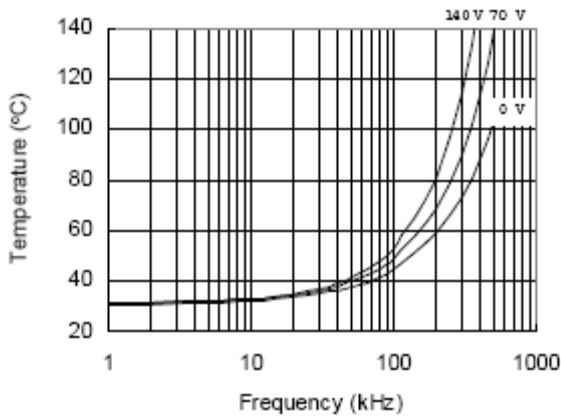

Figure 31. IRS2181S vs. Frequency (IRFBC40),
 $R_{gate}=15\ \Omega$, $V_{CC}=15\ V$

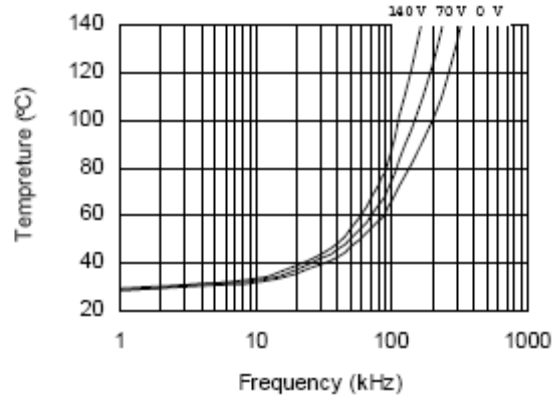

Figure 32. IRS2181S vs. Frequency (IRFPE50),
 $R_{gate}=10\ \Omega$, $V_{CC}=15\ V$

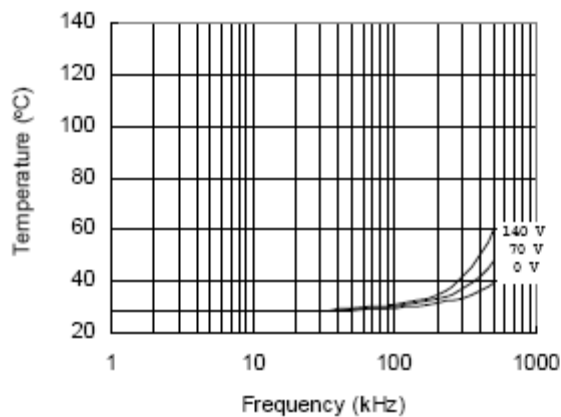

Figure 33. IRS21814S vs. Frequency (IRFBC20),
 $R_{gate}=33\ \Omega$, $V_{CC}=15\ V$

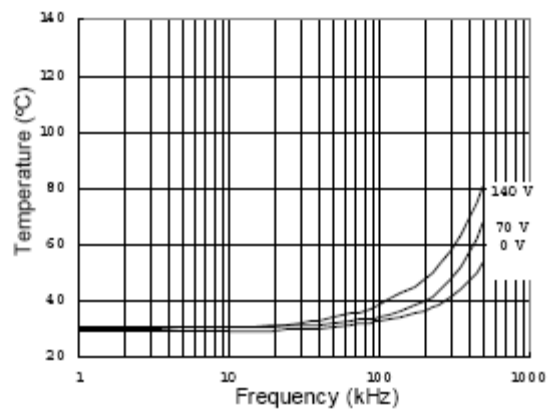

Figure 34. IRS21814S vs. Frequency (IRFBC30),
 $R_{gate}=22\ \Omega$, $V_{CC}=15\ V$

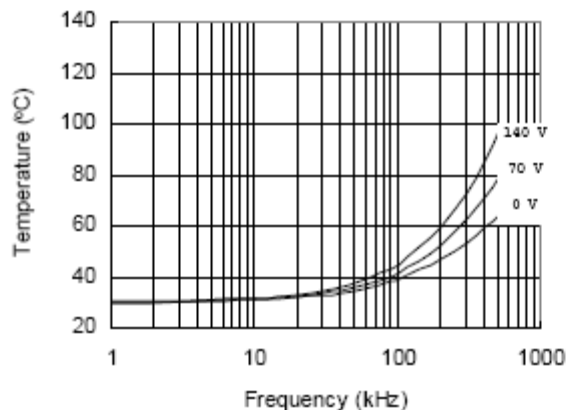

Figure 35. IRS21814S vs. Frequency (IRFBC40),
 $R_{gate}=15\ \Omega$, $V_{CC}=15\ V$

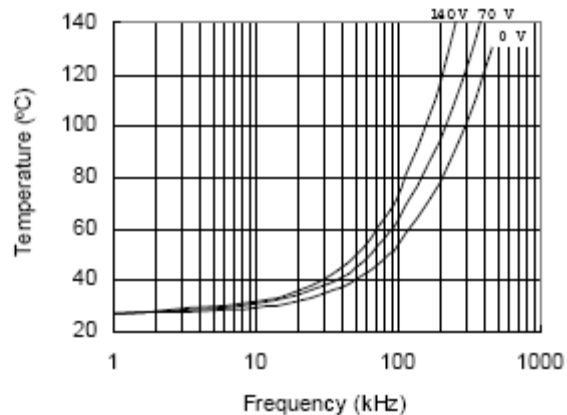
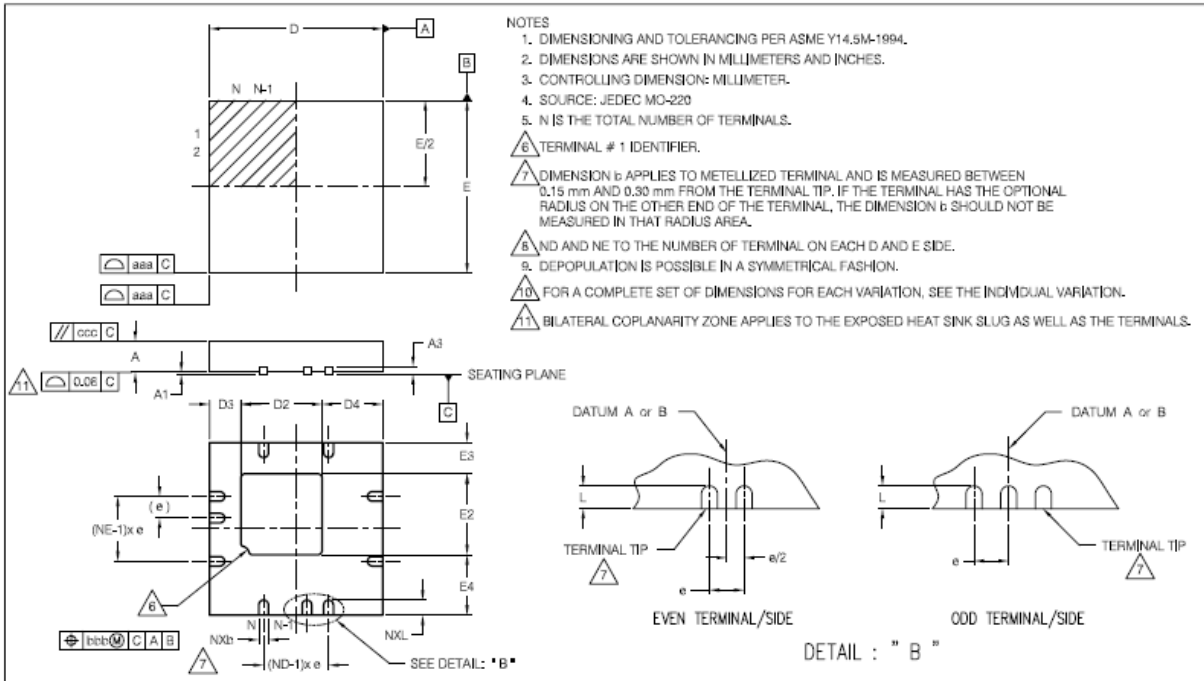

Figure 36. IRS21814S vs. Frequency (IRFPE50),
 $R_{gate}=10\ \Omega$, $V_{CC}=15\ V$

Package Details: MLPQ 4x4 -16L



SYMBOL	VGGD-10					
	MILLIMETERS			INCHES		
	MIN	NOM	MAX	MIN	NOM	MAX
A	0.90	0.90	1.00	.032	.035	.039
A1	0.00	0.02	0.05	.000	.0008	.0019
A3	0.20 REF			.008 REF		
b	0.18	0.25	0.30	.007	.010	.012
D2	1.78	1.88	1.98	.070	.074	.078
D3	0.73 REF			.029 REF		
D4	1.40 REF			.055 REF		
D	4.00 BSC			.157 BSC		
E	4.00 BSC			.157 BSC		
E4	1.40 REF			.055 REF		
E3	0.73 REF			.029 REF		
E2	1.78	1.88	1.98	.070	.074	.078
L	0.30	0.40	0.50	.012	.016	.020
e	0.50 PITCH			.020 PITCH		
N	16			16		
ND	4			4		
NE	4			4		
aaa	0.15			.0059		
bbb	0.10			.0039		
ccc	0.10			.0039		
ddd	0.05			.0019		

Tape and Reel Details: MLPQ 4x4

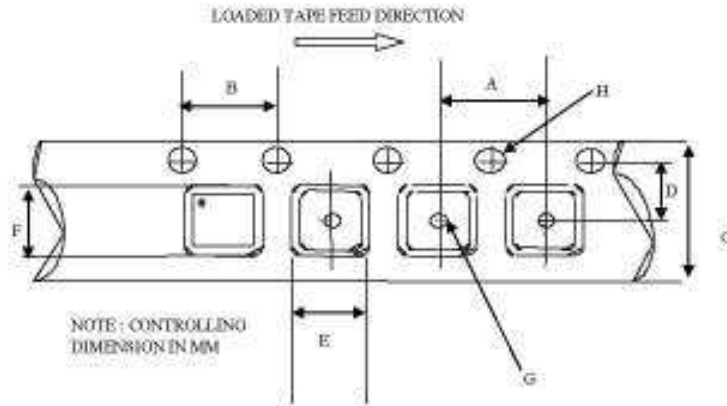

CARRIER TAPE DIMENSION FOR MLPQ4X4V

Code	Metric		Imperial	
	Min	Max	Min	Max
A	7.90	8.10	0.311	0.358
B	3.90	4.10	0.154	0.161
C	11.70	12.30	0.461	0.484
D	5.45	5.55	0.215	0.219
E	4.25	4.45	0.168	0.176
F	4.25	4.45	0.168	0.176
G	1.50	n/a	0.059	n/a
H	1.50	1.60	0.059	0.063

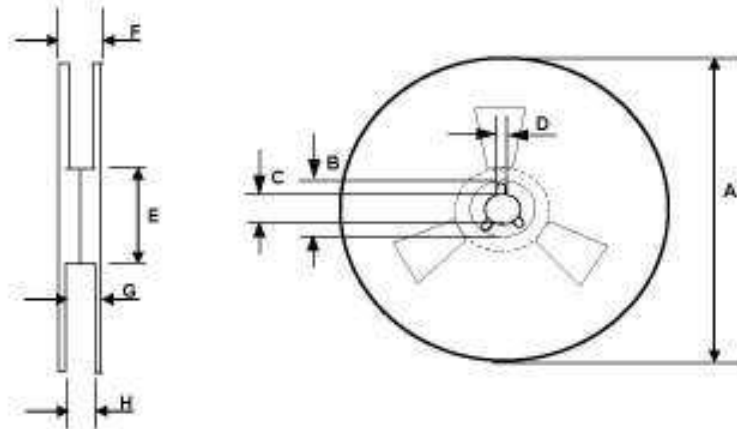

REEL DIMENSIONS FOR MLPQ4X4V

Code	Metric		Imperial	
	Min	Max	Min	Max
A	329.60	330.25	12.976	13.001
B	20.95	21.45	0.824	0.844
C	12.80	13.20	0.503	0.519
D	1.95	2.45	0.767	0.096
E	98.00	102.00	3.858	4.015
F	n/a	18.40	n/a	0.724
G	14.50	17.10	0.570	0.673
H	12.40	14.40	0.488	0.566

Part Marking Information

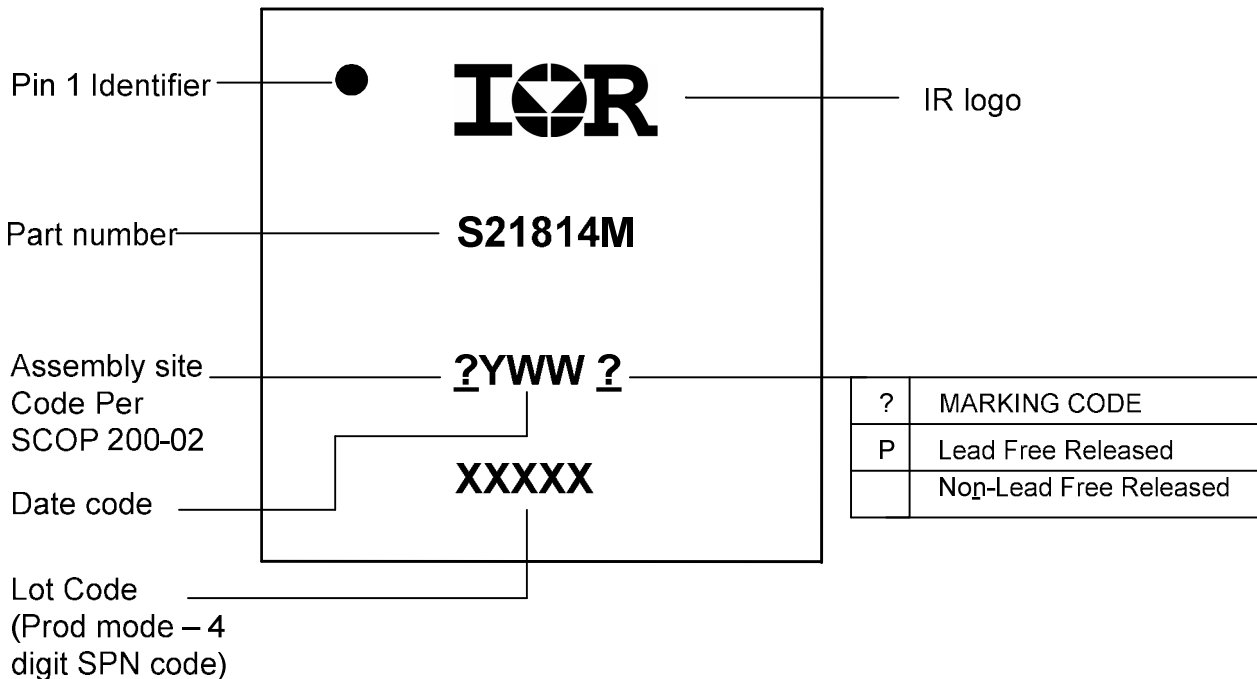

Ordering Information

Base Part Number	Package Type	Standard Pack		Complete Part Number
		Form	Quantity	
IRS21814	MLPQ 4x4-16L	Tube/Bulk	92	IRS21814MPBF
		<i>Tape and Reel</i>	<i>3,000</i>	IRS21814MTRPBF

The information provided in this document is believed to be accurate and reliable. However, International Rectifier assumes no responsibility for the consequences of the use of this information. International Rectifier assumes no responsibility for any infringement of patents or of other rights of third parties which may result from the use of this information. No license is granted by implication or otherwise under any patent or patent rights of International Rectifier. The specifications mentioned in this document are subject to change without notice. This document supersedes and replaces all information previously supplied.

For technical support, please contact IR's Technical Assistance Center
<http://www.irf.com/technical-info/>

WORLD HEADQUARTERS:
 233 Kansas St., El Segundo, California 90245
 Tel: (310) 252-7105

Revision History

Date	Comment
09/24/09	Converted from existing data sheet; changing only package information
03/24/2010	Included Qual Info Page