

POWER

DS1600SPE

1600 Watts Distributed Power System

Data Sheet

Front-end Bulk Power
Total Output Power:
1600 W continuous at high line
Wide Range Input Voltage:
90 - 264 Vac

SPECIAL FEATURES

- 1600 W output power at high line
- High power and short form factor
- 1U power supply
- High density design: 40 W/in³
- Active power factor correction
- EN61000-3-2 harmonic compliance
- Inrush current control
- 80plus platinum efficiency
- N+1 or N+N redundant
- Active current sharing
- Full digital control
- PMBus compliant
- Compatible with Artesyn's universal PMBus GUI
- Reverse airflow option
- Two-year warranty

COMPLIANCE

- Class A + 6 dB margin Conducted/
Radiated EMI
- RoHS compliant

SAFETY

- UL/cUL 60950 (UL Recognized)
- NEMKO+ CB Report EN60950
- EN60950
- CE Mark
- China CQC



Electrical Specifications

Input	
Input voltage range	180 to 264 Vac: 1600 W 90 to 140 Vac: 800 W
Frequency	47 Hz to 63 Hz
Efficiency	94.0% peak
Max input current	10.8 Arms
Inrush current	55 Apk
Conducted EMI	Class A
Radiated EMI	Class A
Power factor	> 0.9 beginning at 20% load
ITHD	10%
Leakage current	1.75 mA
Hold-up time	10 ms

Ordering Information

Model Number	Nominal Main Output	Standby Output	Airflow Direction
DS1600SPE-3	12 V @ 133.3 A	12 V @ 3.5 A	Standard (forward)
DS1600SPE-3-001	12 V @ 133.3 A	12 V @ 3.5 A	Reverse

Electrical Specifications

Output			
Main DC Output	MIN	NOM	MAX
Nominal setting	-0.20%	12	0.20%
Total output regulation range	11.4 V		12.6 V
Dynamic load regulation range ⁵	11.4 V		12.6 V
Output ripple			150 mVp-p
Output current	2 A ⁴		133.33 A
Current sharing	Within +/-5% of full load rating		
Capacitive loading	2,250 μ F		14,000 μ F
Start-up from AC to output			2,300 ms
Output rise time	2 ms		60 ms
Standby DC Output			
Nominal setting	-3%	12	3%
Total output regulation range	11.4 V		12.6 V
Dynamic load regulation range	11.4 V		12.6 V
Output ripple			150 mVp-p
Adjustment range		N/A	
Output current	0.1 A ⁴		3.5 A
Current sharing		N/A	
Capacitive loading	47 μ F		1,000 μ F
Start-up from AC to output	20 ms		2,000 ms
Output rise time	2 ms		60 ms
Protections			
Main Output			
Overcurrent protection ²	115%		150%
Overvoltage protection ¹	13.5 V		15.0 V
Undervoltage Protection	10.5 V		11.0 V
Overtemperature protection		Yes	
Fan fault protection		Yes	
Standby Output			
Overcurrent Protection ³	120%		150%
Overvoltage Protection ¹	13.5 V		15.0 V
Undervoltage Protection	10.0 V		11.0 V

¹ Latch mode

² Autorecovery if the overcurrent is less than 115% and last only for <500 ms

³ Standby protection is auto-recovery

⁴ Minimum current for transient load response testing only. Unit is designed to operate and be within output regulation range at zero load.

⁵ Maximum step size of 67 A at 0.5A/ μ s, with a beginning load of 8 A, and 3,350 μ F capacitance

Control and Status Signals

Input Signals

PSON_L

Active LOW signal which enables/disables the main output. Pulling this signal LOW will turn-on the main output. System Side pull-up resistor is not required.

		MIN	MAX
V_{IL}	Input logic level LOW		0.8 V
V_{IH}	Input logic level HIGH	2.0 V	5.0 V
I_{SOURCE}	Current that may be sourced by this pin		2 mA
I_{SINK}	Current that may be sunk by this pin at low state		0.5 mA

PSKILL_H

First break/last mate active HIGH signal which enables/disables the main output. This signal will have to be pulled to ground at the system side.

		MIN	MAX
V_{IL}	Input logic level LOW. This allows for the power supply to be turned on		0.8 V
V_{IH}	Input logic level HIGH. Immediately shuts down the power supply	2.0 V	5.0 V
I_{SOURCE}	Current that may be sourced by this pin		2 mA
I_{SINK}	Current that may be sunk by this pin at low state		0.5 mA

VSENSE+, VSENSE-

VSENSE+ and VSENSE- lines are the remote sense lines for regulation. Each line will compensate for a maximum of 200 mV.

Output Signals

ACOK

Signal used to indicate the presence of AC input to the power supply. A logic level HIGH will indicate that the AC input to the power supply is within the operating range while a logic level LOW will indicate that AC has been lost.

This is an open collector/drain output. This pin is pulled high by a 1.0 kohm resistor connected to 3.3 V inside the power supply. It is recommended that this pin be connected to a 100 pF decoupling capacitor and pulled down by a 100 kohm resistor.

		MIN	MAX
V_{IL}	Output logic level LOW		0.6 V
V_{IH}	Output logic level HIGH	2.0 V	5.0 V
I_{SOURCE}	Current that may be sourced by this pin		3.3 mA
I_{SINK}	Current that may be sunk by this pin at low state		0.7 mA

PWR_GOOD / PWOK

Signal used to indicate that main output voltage is within regulation range. The PWR_GOOD signal will be driven HIGH when the output voltage is valid and will be driven LOW when the output falls below the under-voltage threshold.

This signal also gives an advance warning when there is an impending power loss due to loss of AC input or system shutdown request. More details in the Timing Section.

This is an open collector/drain output. This pin is pulled high by a 1.0 kohm resistor connected to 3.3 V inside the power supply. It is recommended that this pin be connected to a 100 pF decoupling capacitor and pulled down by a 10 kohm resistor.

		MIN	MAX
V_{IL}	Output logic level LOW		0.8 V
V_{IH}	Output logic level HIGH	2.0 V	5.0 V
I_{SOURCE}	Current that may be sourced by this pin		3.3 mA
I_{SINK}	Current that may be sunk by this pin at low state		0.7 mA

Control and Status Signals

Output Signals

PS_PRESENT

Signal used to indicate to the system that a power supply is inserted in the power bay. This pin is shorted to the standby return in the power supply. Recommended pull-up resistor to 12 VSB is 8.2 k with a 3.0 k pull-down to ground. A 100 pF decoupling capacitor is also recommended.

PS_INTERRUPT

Active low signal used by the power supply to indicate to the system that a change in power supply status has occurred. This event can be triggered by faults such as OVP, OCP, OTP, and fan fault. This signal can be cleared by a CLEAR_FAULT command. Recommended pull-up resistor to 12 VSB is 8.2 k with a 3.0 k pull-down to ground. A 100 pF decoupling capacitor is also recommended.

		MIN	MAX
V_{IL}	Output logic level LOW		0.8 V
V_{IH}	Output logic level HIGH	2.0 V	5.0 V
I_{SOURCE}	Current that may be sourced by this pin		4 mA
I_{SINK}	Current that may be sunk by this pin at low state		4 mA

BUS Signals

ISHARE

Bus signal used by the power supply for active current sharing. All power supplies configured in the system for n+n sharing will refer to this bus voltage in order to load share.

Voltage Range	The range of this signal for active sharing will be up to 8.0 V, which corresponds to the maximum output current.		
		MIN	MAX
I_{SHARE} Voltage	Voltage at 100% load, stand-alone unit	7.75	8.25
	Voltage at 50% load, stand-alone unit	3.85	4.15
I_{SOURCE}	Current that may be sourced by this pin		160 mA

SCL, SDA, A0, A1, A2

Clock, data and addressing signals defined as per I2C requirements. It is recommended that these pins be pulled-up to a 2.2 kohm resistor to 3.3 V and a 22 pF decoupling capacitor at the system side.

		MIN	MAX
V_L	Logic level LOW		0.8 V
V_H	Logic level HIGH	2.0 V	5.0 V

Note: All signal noise levels are below 400 mVpk-pk from 0 - 100 MHz.

I²C Addressing Table

A2	A1	A0	PMBus (W/R)	FRU (W/R)
0	0	0	B0/B1	A0/A1
0	0	1	B2/B3	A2/A3
0	1	0	B4/B5	A4/A5
0	1	1	B6/B7	A6/A7
1	0	0	B8/B9	A8/A9
1	0	1	BA/BB	AA/AB
1	1	0	BC/BD	AC/AD
1	1	1	BE/BF	AE/AF

Electrical Specifications

LED Indicators

A single bi-color LED is used to indicate the power supply status.

	Status LED
No AC input to PSU	Off
Main output ON	Solid GREEN
Standby mode and Power supply failure (OCP, OVP, OTP, FAN FAULT)	Blinking AMBER

Firmware Reporting And Monitoring

	Accuracy Range		
Output loading	8 to 20%	20% to 50%	50% to 100%
Input voltage	±5%		
Input current	±0.55A	±5%	
Input power	±5W at <125 W input power	±1.25%	
Output voltage	±2%		
Output current	±1.2 A fixed error	±3%	
Temperature	±5 degC on the operating range		
E_{IN}	±15% from 10% to 20% load	±5%	
Fan speed	±250 RPM		

PMBus	YES
Remote ON/OFF	YES

Electrical Specifications

Timing Specifications				
	Description	Min	Max	Unit
T_{sb_On}	Delay from AC being applied to standby output being within regulation	20	2000	ms
T_{sb_ACOK}	Delay from standby output to ACOK assertion	See note below	20	ms
T_{sb_Vout}	Delay from standby output to main output voltage being within regulation		300	ms
$T_{AC_On_Delay}$	Delay from AC being applied to main output being within regulation		2300	ms
T_{PWOK_On}	Delay from output voltages within regulation limits to PWOK asserted	100	1000	ms
T_{ACOK_Delay}	Delay from loss of AC to assertion of ACOK		7	ms
$T_{PWOK_Hold-up}$	Delay from loss of AC to deassertion of PWOK	10		ms
$T_{Vout_Hold-up}$	Delay from loss of AC to main output being within regulation	11		ms
$T_{sb_Hold-up}$	Delay from loss of AC to standby output being within regulation	150		ms
$T_{PWR_GOOD_Off}$	Delay from deassertion of PWOK to output falling out of regulation	1		ms
$T_{PSON_On_Delay}$	Delay from PS_ON assertion to output being within regulation		150	ms
T_{PWOK_Low}	Duration of PWOK being in deasserted state during an ON/OFF cycle of PSU	N/A	N/A	

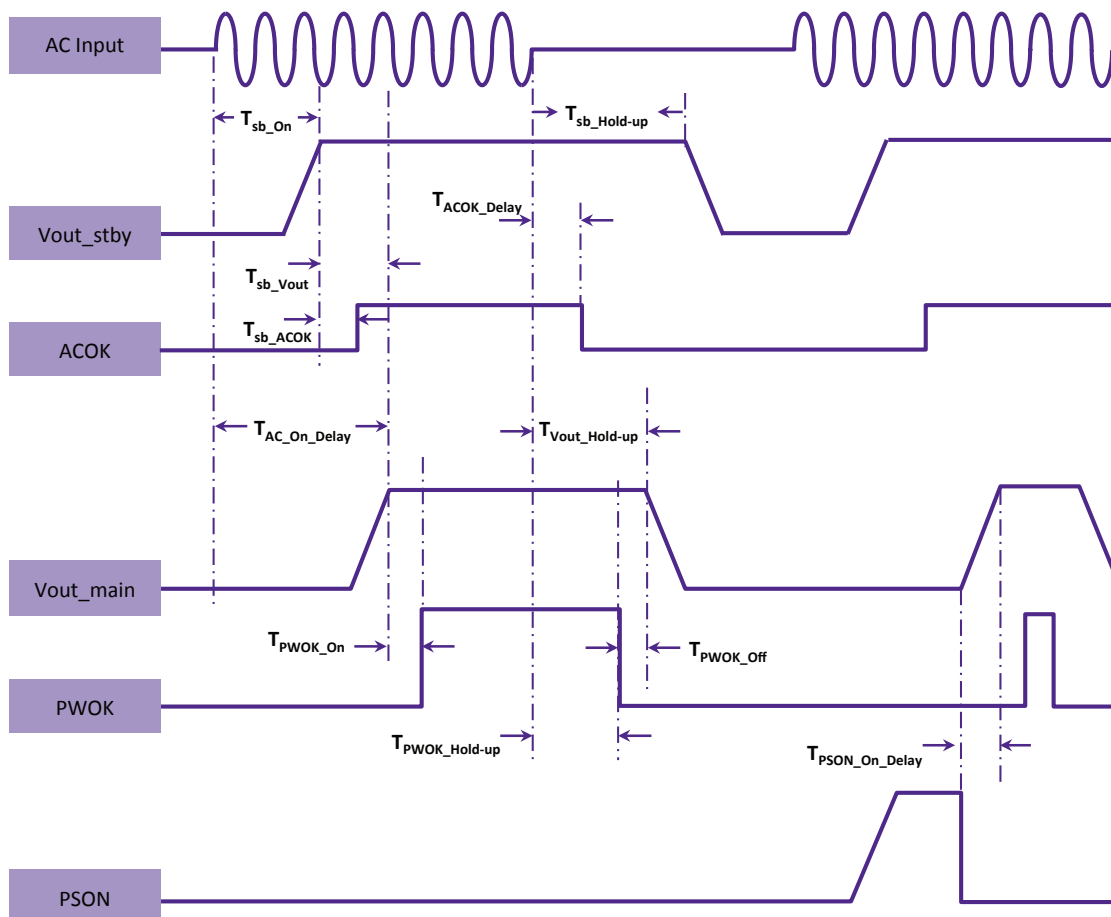

Note: $T_{sb_hold-up}$: tested at 1A load on standby output
 T_{sb_ACOK} : ACOK can assert earlier than the standby output

Timing Diagram

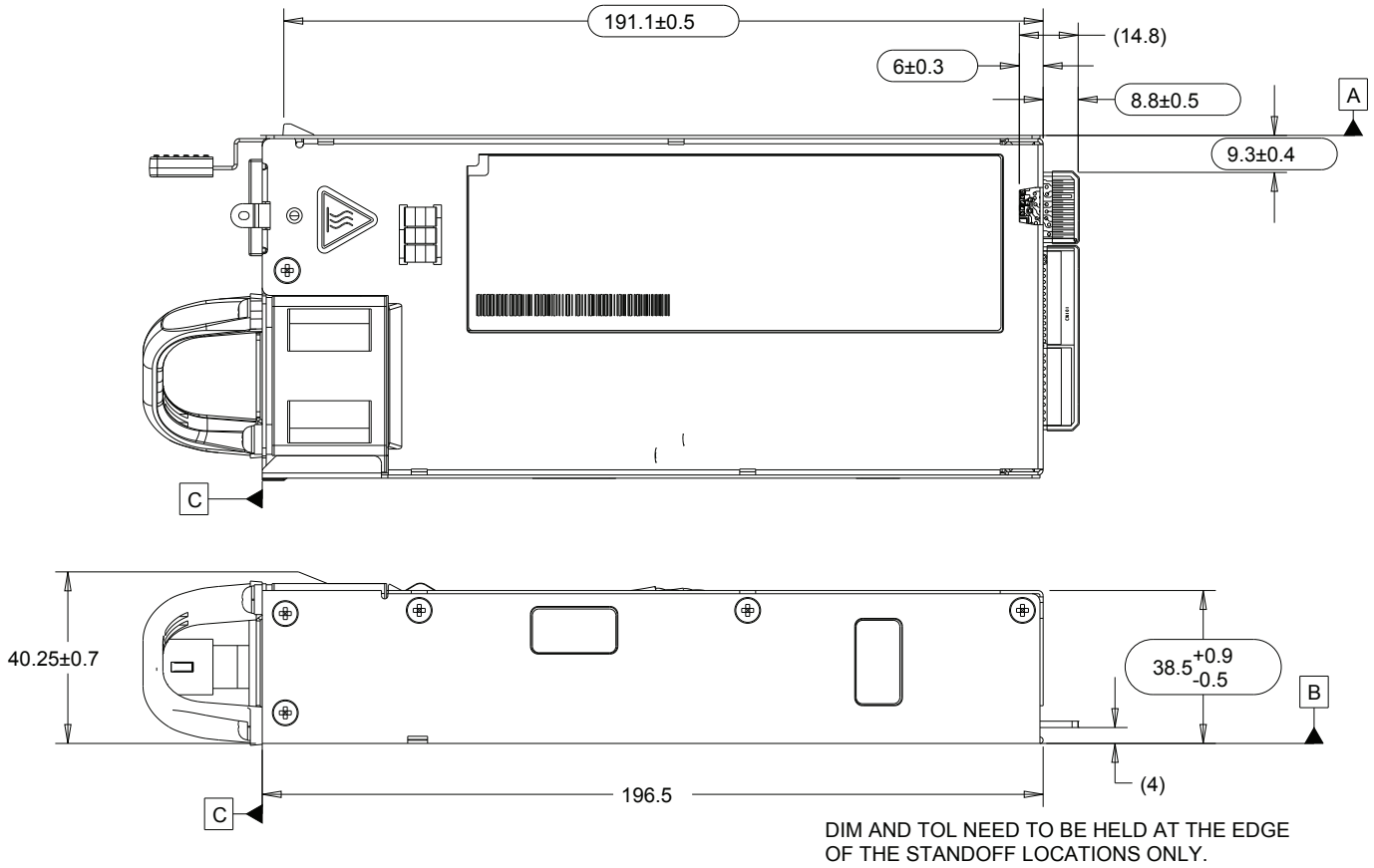

Mechanical Outline



MODEL	AIRFLOW DIRECTION
DS1600SPE-3	FORWARD 
DS1600SPE-3-001	REVERSE 

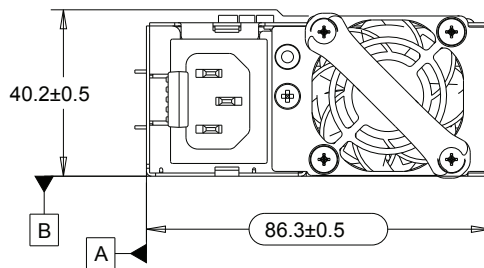

Connector Definitions

Output Connector Part Number	Card-edge
Mating Connector Part Number	FCI 10107844-002LF or any equivalent

Power Supply Output Card Edge (Bottom Side)

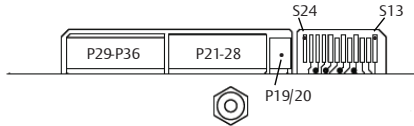

Power Supply Output Card Edge (Top Side)

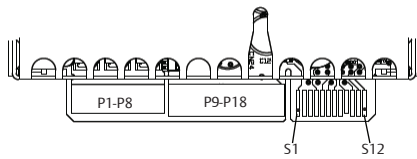

Output Connector Pin Configuration

S1	PS_PRESENT	S13	PS_ON_L
S2	A1	S14	PSKILL_H
S3	A0	S15	RESERVED
S4	PWR_GOOD (PWOK)	S16	RTN
S5	ACOK (AC Input Present)	S17	SDA
S6	RTN	S18	RTN
S7	I_SHARE	S19	SCL
S8	RESERVED	S20	RTN
S9	PS_INTERRUPT_L	S21	REMOTE SENSE -
S10	RETURN	S22	RTN
S11	RESERVED	S23	REMOTE SENSE +
S12	RESERVED	S24	A2
P1-P8	+12VOUT	P19-P20	+VSB
P9-P18	RETURN	P21-P28	RETURN
		P29-P36	+12VOUT

Environmental Specifications

Operating temperature	Ds1600SPE-3: 1600W from 0 to 50 °C, can operate up to 65°C at 2% derated power for every °C above 50°C DS1600SPE-3-001: 1600W from 0 to 40°C, can operate up to 60°C at 1% derated power for every °C above 40°C
Operating altitude	up to 16,400 feet, derated after 10,000 feet
Operating relative humidity	5% to 95% non-condensing
Non-operating temperature	-40 to +70 °C
Non-operating relative humidity	5% to 95% non-condensing
Non-operating altitude	up to 50,000 feet
Vibration and shock	Standard operating and non-operating random shock and vibration
ROHS compliance	Yes
MTBF	1,100,000 hours using Bell Core TR-332, issue 6 specification, Method 1 Case 3 at 25 °C ambient at full load.
Operating life	Minimum of 5 years

WORLDWIDE OFFICES

Americas

2900 S.Diablo Way
Tempe, AZ 85282
USA
+1 888 412 7832

Europe (UK)

Waterfront Business Park
Merry Hill, Dudley
West Midlands, DY5 1LX
United Kingdom
+44 (0) 1384 842 211

Asia (HK)

14/F, Lu Plaza
2 Wing Yip Street
Kwun Tong, Kowloon
Hong Kong
+852 2176 3333

ARTESYN[™]
EMBEDDED TECHNOLOGIES

www.artesyn.com

Artesyn Embedded Technologies, Artesyn and the Artesyn Embedded Technologies logo are trademarks and service marks of Artesyn Embedded Technologies, Inc. All other names and logos referred to are trade names, trademarks, or registered trademarks of their respective owners. © 2016 Artesyn Embedded Technologies, Inc. All rights reserved. For full legal terms and conditions, please visit www.artesyn.com/legal.

For more information: www.artesyn.com/power
For support: productsupport.ep@artesyn.com