

ohne / without

Mutter / nut
max. Einschraubtiefe 3.7 mm
thread depth max. 3.7 mm

Bolzen / bolt
max. Einschraubtiefe 5.5 mm
thread depth max. 5.5 mm

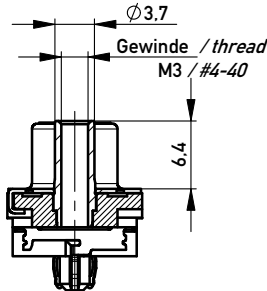
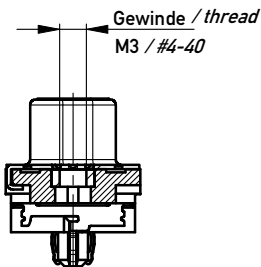
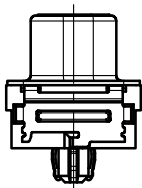

Beschriftung nach Bedruckungsvorschrift 174538
Part marking according to specification 174538

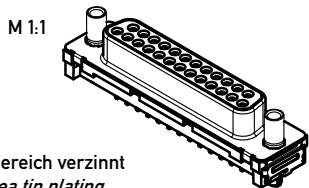

Anschlussbereich verzinkt
terminal area tin plating

Anforderungsstufe: 2
class: 2

194385	X			
194386			#4-40	
194387			M3	
194388		#4-40		
194389		M3		
Ident.-Nr. part-no.	ohne without	Mutter thread	Bolzen bolt	Bemerkung remark

Verpackt in Tray
Verpackungseinheit 30 St.
tray packaging
packaging unit 30 pcs

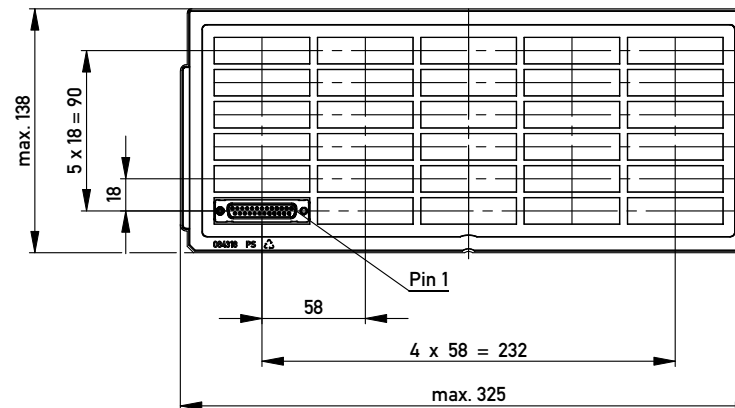

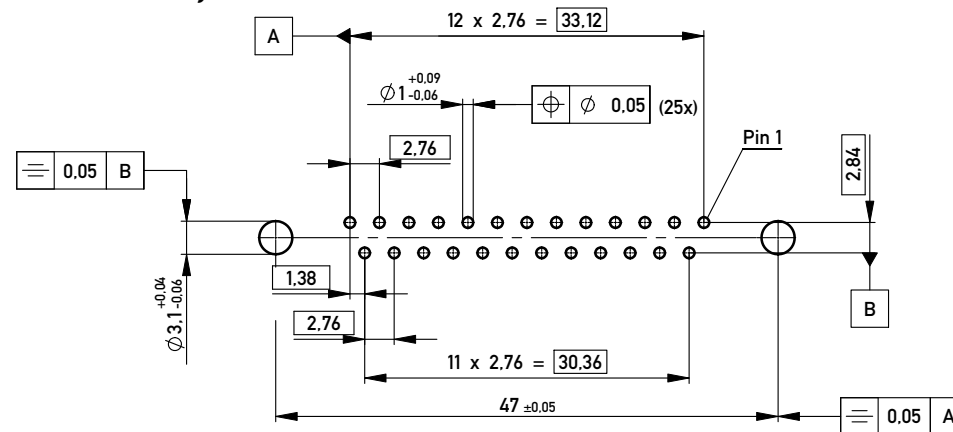

Sonstige Angaben siehe Zeichnung 204628 / Additional indications according to drawing 204628

Layoutvorschlag:
recommended layout:



Lochaufbau siehe ERNI-Spezifikation 164062 / hole design according to ERNI-specification 164062

Fehlende Masse und Angaben siehe DIN 41652 / Missing information and dimensions according to DIN 41652
Sonstige Angaben siehe Fertigungsunterlagen / Additional indications according to the production documentation

Information: All rights reserved. Only for Information. To ensure that this is the latest version of this drawing, please contact one of the ERNI companies before using.	Tolerances  All Dimensions in mm	Scale 2:1
	Subject to modification without prior notice. Drawing will not be updated.	Designation TMC-S 25-EE-3.0-6.3-BA8 TMC-S 25-EE-3.0-6.3-type 8
 www.ERNI.com	144918	I A3
B Index	25.02.2010 Date	Class TMCS

Copyright by ERNI GmbH
Proprietary notice pursuant to ISO 16016 to be observed.