

SECTION A-A
SCALE 4 : 1

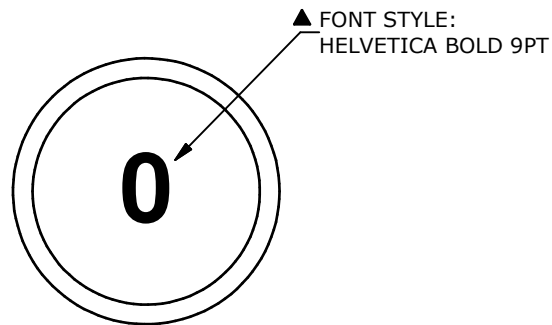

GRAPHIC VIEW

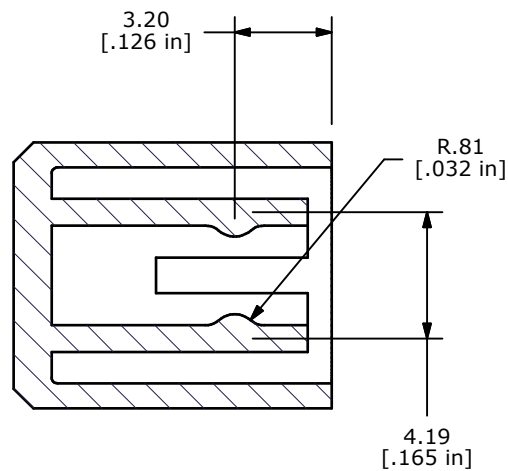
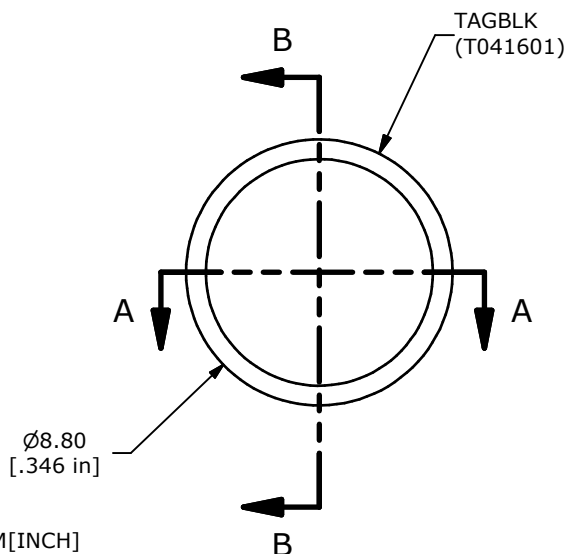
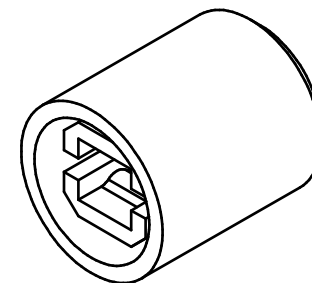

SECTION B-B
SCALE 4 : 1

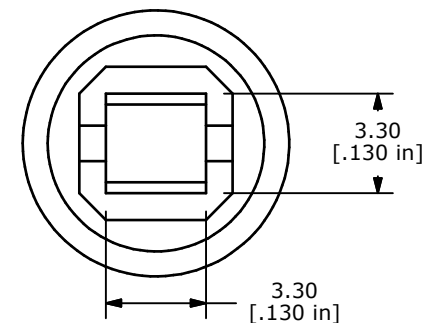

NOTES:

1. ALL DIMENSIONS IN MM[INCH]
2. GENERAL TOLERANCE: X.XX=± 0.15
- ▲3. MATERIAL: ABS UL94HB
- ▲4. COLOR: BLACK, PANTONE 3C
5. ▲ DENOTES CRITICAL PARAMETER
- ▲6. GRAPHIC COLOR: PANTONE 538C
7. 2002/95/EC (ROHS) COMPLIANT



B	17594	CHANGED DETENT RIB PLACEMENT	8/27/07	BF
A	15962	NEW RELEASE	4/14/06	CT
REV	PCR NO	DESCRIPTION	DATE	BY

TITLE TAGBLK "0"				
SCALE 4:1	DATE 8/27/2007	DR BF	DWG T041649	REV B

THE INFORMATION CONTAINED IN THIS DOCUMENT IS PROPRIETARY TO E-SWITCH AND IS NOT TO BE COPIED OR TRANSFERRED