

NOA3302

Digital Proximity Sensor with Ambient Light Sensor and Interrupt

Description

The NOA3302 combines an advanced digital proximity sensor and LED driver with an ambient light sensor (ALS) and tri-mode I²C interface with interrupt capability in an integrated monolithic device. Multiple power management features and very low active sensing power consumption directly address the power requirements of battery operated mobile phones and mobile internet devices.

The proximity sensor measures reflected light intensity with a high degree of precision and excellent ambient light rejection. The NOA3302 enables a proximity sensor system with a 32:1 programmable LED drive current range and a 30 dB overall proximity detection threshold range. The photopic light response, dark current compensation and high sensitivity of the ambient light sensor eliminates inaccurate light level detection, insuring proper backlight control even in the presence of dark cover glass.

The NOA3302 is ideal for improving the user experience by enhancing the screen interface with the ability to measure distance for near/far detection in real time and the ability to respond to ambient lighting conditions to control display backlight intensity.

Features

- Proximity Sensor, LED driver and ALS in One Device
- Very Low Power Consumption
 - ◆ Stand-by Current 5 μ A (monitoring I²C interface only, V_{DD} = 3 V)
 - ◆ ALS Operational Current 50 μ A
 - ◆ Proximity Sensing Average Operational Current 100 μ A
 - ◆ Average LED Sink Current 75 μ A

Proximity Sensing

- Proximity Detection Distance Threshold I²C Programmable with 12-bit Resolution and Four integration Time Ranges (15-bit effective resolution)
- Effective for Measuring Distances up to 100 mm and Beyond
- Excellent IR and Ambient Light Rejection Including Sunlight (up to 50k lux) and CFL Interference
- Programmable LED Drive Current from 5 mA to 160 mA in 5 mA steps, No External Resistor Required

Ambient Light Sensing

- ALS Senses Ambient Light and Provides a 16-bit Output Count on the I²C Bus Directly Proportional to the Ambient Light Intensity



ON Semiconductor®

<http://onsemi.com>

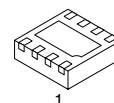

CWDFN8
CU SUFFIX
CASE 505AJ

PIN CONNECTIONS

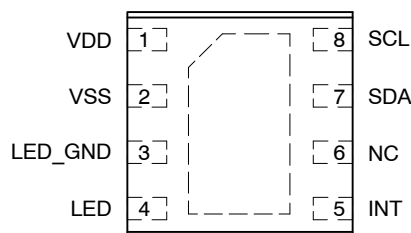

(Top View)

ORDERING INFORMATION

Device	Package	Shipping [†]
NOA3302CUTAG*	CWDFN8 (Pb-Free)	2500 / Tape & Reel

[†]For information on tape and reel specifications, including part orientation and tape sizes, please refer to our Tape and Reel Packaging Specifications Brochure, BRD8011/D.

*Temperature Range: -40°C to 80°C.

- Photopic Spectral Response Nearly Matches Human Eye
- Dynamic Dark Current Compensation
- Linear Response Over the Full Operating Range
- Senses Intensity of Ambient Light from 0.05 lux to 52k lux with 21-bit Effective Resolution (16-bit converter)
- Continuously Programmable Integration Times (6.25 ms, 12.5 ms, 25 ms... to 800 ms)
- Precision on-Chip Oscillator (counts equal 0.1 lux at 100 ms integration time)

NOA3302

Additional Features

- Programmable interrupt function including independent upper and lower threshold detection or threshold based hysteresis for proximity and or ALS
- Proximity persistence feature reduces interrupts by providing hysteresis to filter fast transients such as camera flash
- Automatic power down after single measurement or continuous measurements with programmable interval time for both ALS and PS function
- Wide operating voltage range (2.3 V to 3.6 V)
- Wide operating temperature range (-40°C to 80°C)
- I²C serial communication port
 - ◆ Standard mode – 100 kHz

- ◆ Fast mode – 400 kHz
- ◆ High speed mode – 3.4 MHz
- No external components required except the IR LED and power supply Decoupling Caps
- 8-lead CUDFN 2.0 x 2.0 x 0.6 mm clear package
- These Devices are Pb-Free, Halogen Free/BFR Free and are RoHS Compliant

Applications

- Senses human presence in terms of distance and senses ambient light conditions, saving display power in applications such as:
 - ◆ Smart phones, mobile internet devices, MP3 players, GPS
 - ◆ Mobile device displays and backlit keypads

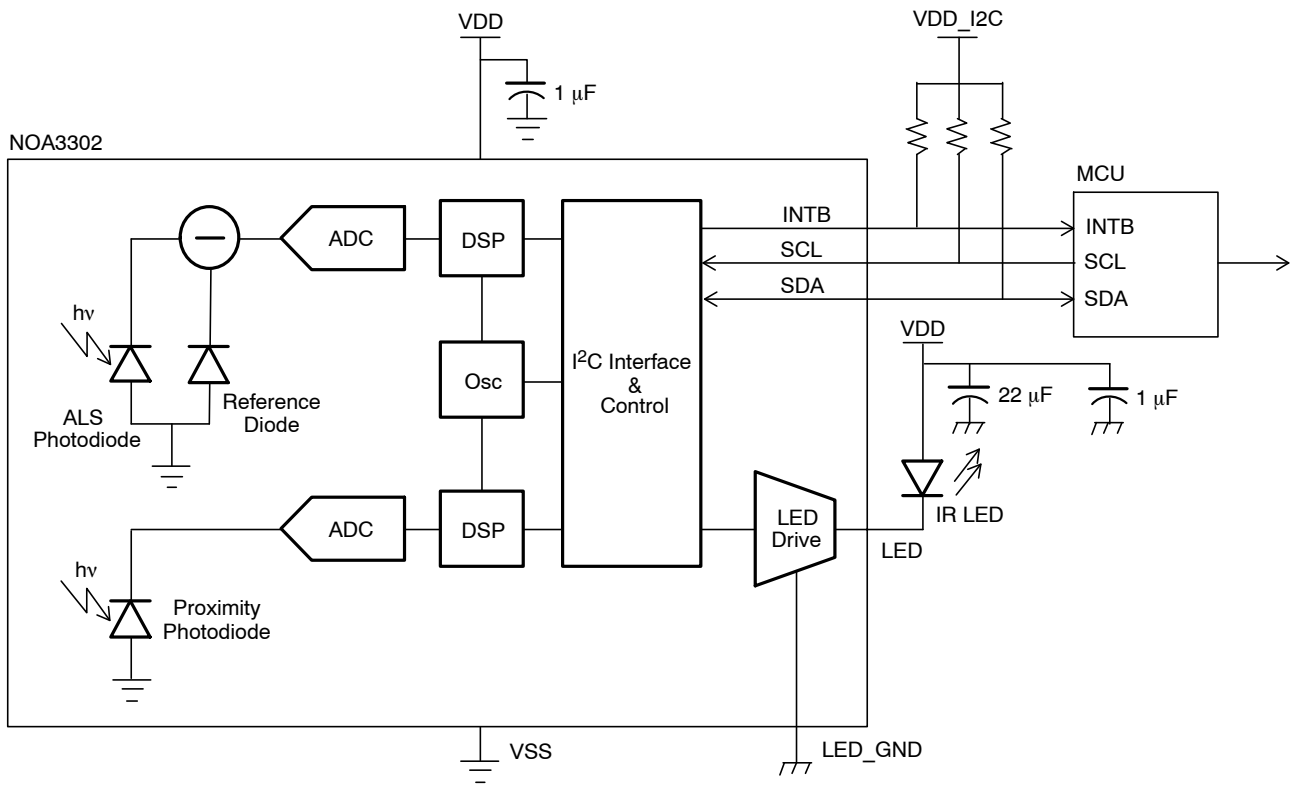

Figure 1. NOA3302 Application Block Diagram

Table 1. PIN FUNCTION DESCRIPTION

Pin	Pin Name	Description
1	VDD	Power pin.
2	VSS	Ground pin.
3	LED_GND	Ground pin for IR LED driver.
4	LED	IR LED output pin.
5	INT	Interrupt output pin, open-drain.
6	NC	Not connected.
7	SDA	Bi-directional data signal for communications with the I ² C master.
8	SCL	External I ² C clock supplied by the I ² C master.

Table 2. ABSOLUTE MAXIMUM RATINGS

Rating	Symbol	Value	Unit
Input power supply	VDD	4.0	V
Input voltage range	V _{in}	-0.3 to VDD + 0.2	V
Output voltage range	V _{out}	-0.3 to VDD + 0.2	V
Maximum Junction Temperature	T _{J(max)}	100	°C
Storage Temperature	T _{STG}	-40 to 80	°C
ESD Capability, Human Body Model (Note 1)	ESD _{HBM}	2	kV
ESD Capability, Charged Device Model (Note 1)	ESD _{CDM}	500	V
ESD Capability, Machine Model (Note 1)	ESD _{MM}	200	V
Moisture Sensitivity Level	MSL	3	-
Lead Temperature Soldering (Note 2)	T _{SLD}	260	°C

Stresses exceeding Maximum Ratings may damage the device. Maximum Ratings are stress ratings only. Functional operation above the Recommended Operating Conditions is not implied. Extended exposure to stresses above the Recommended Operating Conditions may affect device reliability.

1. This device incorporates ESD protection and is tested by the following methods:

ESD Human Body Model tested per EIA/JESD22-A114

ESD Charged Device Model tested per ESD-STM5.3.1-1999

ESD Machine Model tested per EIA/JESD22-A115

Latchup Current Maximum Rating: ≤ 100 mA per JEDEC standard: JESD78

2. For information, please refer to our Soldering and Mounting Techniques Reference Manual, SOLDERRM/D

Table 3. OPERATING RANGES

Rating	Symbol	Min	Typ	Max	Unit
Power supply voltage	VDD	2.3		3.6	V
Power supply current, stand-by mode (VDD = 3.0 V)	IDD _{STBY_3.0}			5	μA
Power supply current, stand-by mode (VDD = 3.6 V)	IDD _{STBY_3.6}			10	μA
Power supply average current, ALS operating 100 ms integration time and 500 ms intervals	IDD _{ALS}			50	μA
Power supply average current, PS operating 300 μs integration time and 100 ms intervals	IDD _{PS}			100	μA
LED average sink current, PS operating at 300 μs integration time and 100 ms intervals and LED current set at 50 mA	I _{LED}		75		μA
I ² C signal voltage (Note 3)	VDD_I2C	1.6	1.8	2.0	V
Low level input voltage (VDD_I2C related input levels)	V _{IL}	-0.3		0.3 VDD_I2C	V
High level input voltage (VDD_I2C related input levels)	V _{IH}	0.7 VDD_I2C		VDD_I2C + 0.2	V
Hysteresis of Schmitt trigger inputs	V _{hys}	0.1 VDD_I2C			V
Low level output voltage (open drain) at 3 mA sink current (INTB)	V _{OL}			0.2 VDD_I2C	V
Input current of IO pin with an input voltage between 0.1 VDD and 0.9 VDD	I _I	-10		10	μA
Output low current (INTB)	I _{OL}	3		-	mA
Operating free-air temperature range	T _A	-40		80	°C

3. The I²C interface is functional to 3.0 V, but timing is only guaranteed up to 2.0 V. High Speed mode is guaranteed to be functional to 2.0 V.

NOA3302

Table 4. ELECTRICAL CHARACTERISTICS (Unless otherwise specified, these specifications apply over 2.3 V < VDD < 3.3 V, 1.7 V < VDD_I2C < 1.9 V, -40°C < T_A < 80°C, 10 pF < C_b < 100 pF) (See Note 4)

Parameter	Symbol	Min	Typ	Max	Unit
LED pulse current	I _{LED_pulse}	5		160	mA
LED pulse current step size	I _{LED_pulse_step}		5		mA
LED pulse current accuracy	I _{LED_acc}	-20		+20	%
Interval Timer Tolerance	ToI _{f_timer}	-35		+35	%
SCL clock frequency	f _{SCL_std}	10		100	kHz
	f _{SCL_fast}	100		400	
	f _{SCL_hs}	100		3400	
Hold time for START condition. After this period, the first clock pulse is generated.	T _{HD;STA_std}	4.0		-	μS
	t _{HD;STA_fast}	0.6		-	
	t _{HD;STA_hs}	0.160		-	
Low period of SCL clock	t _{LOW_std}	4.7		-	μS
	t _{LOW_fast}	1.3		-	
	t _{LOW_hs}	0.160		-	
High period of SCL clock	t _{HIGH_std}	4.0		-	μS
	t _{HIGH_fast}	0.6		-	
	t _{HIGH_hs}	0.060		-	
SDA Data hold time	t _{HD;DAT_d_std}	0		3.45	μS
	t _{HD;DAT_d_fast}	0		0.9	
	t _{HD;DAT_d_hs}	0		0.070	
SDA Data set-up time	t _{SU;DAT_std}	250		-	nS
	t _{SU;DAT_fast}	100		-	
	t _{SU;DAT_hs}	10		-	
Rise time of both SDA and SCL (input signals) (Note 5)	t _{r_INPUT_std}	20		1000	nS
	t _{r_INPUT_fast}	20		300	
	t _{r_INPUT_hs}	10		40	
Fall time of both SDA and SCL (input signals) (Note 5)	t _{f_INPUT_std}	20		300	nS
	t _{f_INPUT_fast}	20		300	
	t _{f_INPUT_hs}	10		40	
Rise time of SDA output signal (Note 5)	t _{r_OUT_std}	20		300	nS
	t _{r_OUT_fast}	20 + 0.1 C _b		300	
	t _{r_OUT_hs}	10		80	
Fall time of SDA output signal (Note 5)	t _{f_OUT_std}	20		300	nS
	t _{f_OUT_fast}	20 + 0.1 C _b		300	
	t _{f_OUT_hs}	10		80	
Set-up time for STOP condition	t _{SU;STO_std}	4.0		-	μS
	t _{SU;STO_fast}	0.6		-	
	t _{SU;STO_hs}	0.160		-	
Bus free time between STOP and START condition	t _{BUF_std}	4.7		-	μS
	t _{BUF_fast}	1.3		-	
	t _{BUF_hs}	0.160		-	

4. Refer to Figure 2 and Figure 3 for more information on AC characteristics.

5. The rise time and fall time are dependent on both the bus capacitance (C_b) and the bus pull-up resistor R_p. Max and min pull-up resistor values are determined as follows: R_{p(max)} = t_{r(max)} / (0.8473 × C_b) and R_{p(min)} = (V_{dd_I2C} - V_{ol(max)}) / I_{ol}.

6. C_b = capacitance of one bus line, maximum value of which including all parasitic capacitances should be less than 100 pF. Bus capacitance up to 400 pF is supported, but at relaxed timing.

NOA3302

Table 4. ELECTRICAL CHARACTERISTICS (Unless otherwise specified, these specifications apply over 2.3 V < VDD < 3.3 V, 1.7 V < VDD_I2C < 1.9 V, -40°C < T_A < 80°C, 10 pF < C_b < 100 pF) (See Note 4) (continued)

Parameter	Symbol	Min	Typ	Max	Unit
Capacitive load for each bus line (including all parasitic capacitance) (Note 6)	C _b	10		100	pF
Noise margin at the low level (for each connected device – including hysteresis)	V _{nL}	0.1 VDD		–	V
Noise margin at the high level (for each connected device – including hysteresis)	V _{nH}	0.2 VDD		–	V

4. Refer to Figure 2 and Figure 3 for more information on AC characteristics.
5. The rise time and fall time are dependent on both the bus capacitance (C_b) and the bus pull-up resistor R_p. Max and min pull-up resistor values are determined as follows: R_{p(max)} = t_{r(max)} / (0.8473 × C_b) and R_{p(min)} = (V_{dd_I2C} – V_{ol(max)}) / I_{ol}.
6. C_b = capacitance of one bus line, maximum value of which including all parasitic capacitances should be less than 100 pF. Bus capacitance up to 400 pF is supported, but at relaxed timing.

Table 5. OPTICAL CHARACTERISTICS (Unless otherwise specified, these specifications are for VDD = 3.3 V, T_A = 25°C)

Parameter	Symbol	Min	Typ	Max	Unit
AMBIENT LIGHT SENSOR					
Spectral response, peak (Note 7)	λ _p		560		nm
Spectral response, low -3 dB	λ _{c_low}		510		nm
Spectral response, high -3 dB	λ _{c_high}		610		nm
Dynamic range	DR _{ALS}	0.05		52k	lux
Maximum Illumination (ALS operational but saturated)	E _{v_Max}			120k	lux
Resolution, Counts per lux, T _{int} = 800 ms	CR ₈₀₀		80		counts
Resolution, Counts per lux, T _{int} = 100 ms	CR ₁₀₀		10		counts
Resolution, Counts per lux, T _{int} = 6.25 ms	CR _{6.25}		6.25		counts
Illuminance responsivity, green 560 nm LED, E _v = 100 lux, T _{int} = 100 ms	R _{v_g100}		1000		counts
Illuminance responsivity, green 560 nm LED, E _v = 1000 lux, T _{int} = 100 ms	R _{v_g1000}		10000		counts
Dark current, E _v = 0 lux, T _{int} = 100 ms	R _{vd}	0	0	3	counts
PROXIMITY SENSOR					
Detection range, T _{int} = 1200 μs, I _{LED} = 100 mA, 860 nm IR LED (OSRAM SFH4650), White Reflector (RGB = 220, 224, 223), SNR = 6:1	D _{PS_1200_WHITE}		100		mm
Detection range, T _{int} = 600 μs, I _{LED} = 100 mA, 860 nm IR LED (OSRAM SFH4650), White Reflector (RGB = 220, 224, 223), SNR = 6:1	D _{PS_600_WHITE}		85		mm
Detection range, T _{int} = 300 μs, I _{LED} = 100 mA, 860 nm IR LED (OSRAM SFH4650), White Reflector (RGB = 220, 224, 223), SNR = 6:1	D _{PS_300_WHITE}		60		mm
Detection range, T _{int} = 150 μs, I _{LED} = 100 mA, 860 nm IR LED (OSRAM SFH4650), White Reflector (RGB = 220, 224, 223), SNR = 6:1	D _{PS_150_WHITE}		35		mm
Detection range, T _{int} = 1200 μs, I _{LED} = 100 mA, 860 nm IR LED (OSRAM SFH4650), Grey Reflector (RGB = 162, 162, 160), SNR = 6:1	D _{PS_1200_GREY}		70		mm
Detection range, T _{int} = 1200 μs, I _{LED} = 100 mA, 860 nm IR LED (OSRAM SFH4650), Black Reflector (RGB = 16, 16, 15), SNR = 6:1	D _{PS_1200_BLACK}		35		mm
Saturation power level	P _{DMAX}		1.0		mW/cm ²
Measurement resolution, T _{int} = 150 μs	MR ₁₅₀		12		bits
Measurement resolution, T _{int} = 300 μs	MR ₃₀₀		13		bits
Measurement resolution, T _{int} = 600 μs	MR ₆₀₀		14		bits
Measurement resolution, T _{int} = 1200 μs	MR ₁₂₀₀		15		bits

7. Refer to Figure 4 for more information on spectral response.

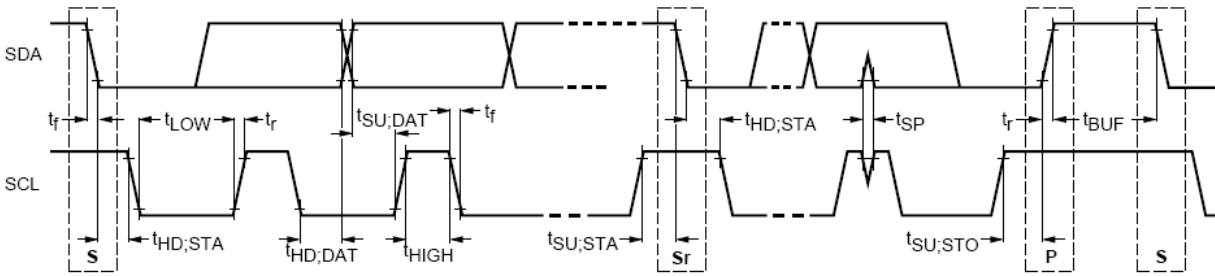

Figure 2. AC Characteristics, Standard and Fast Modes

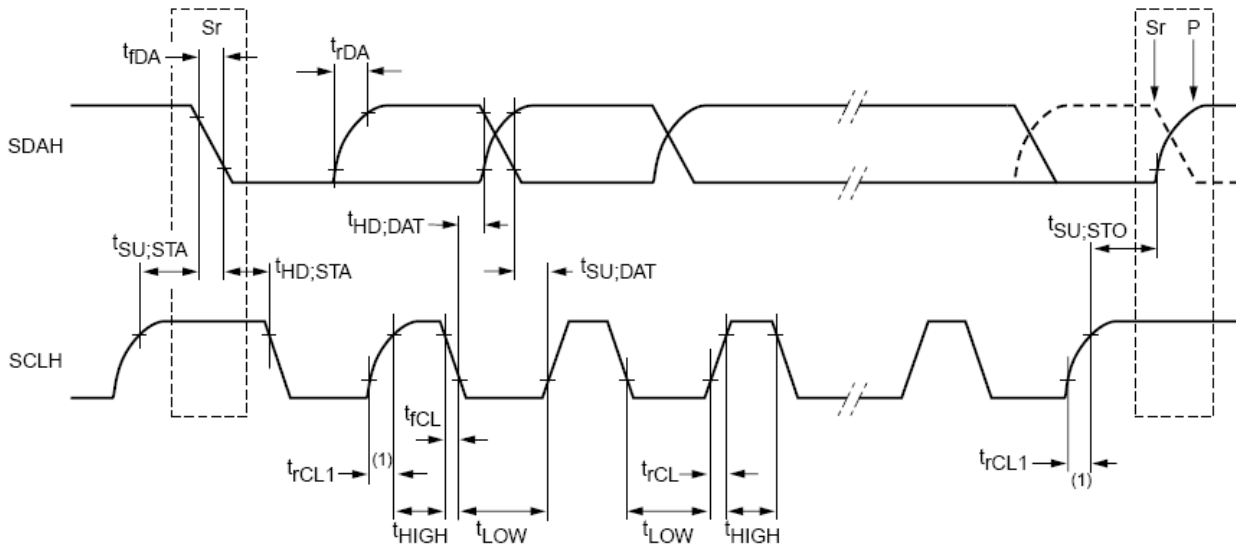

Figure 3. AC Characteristics, High Speed Mode

TYPICAL CHARACTERISTICS

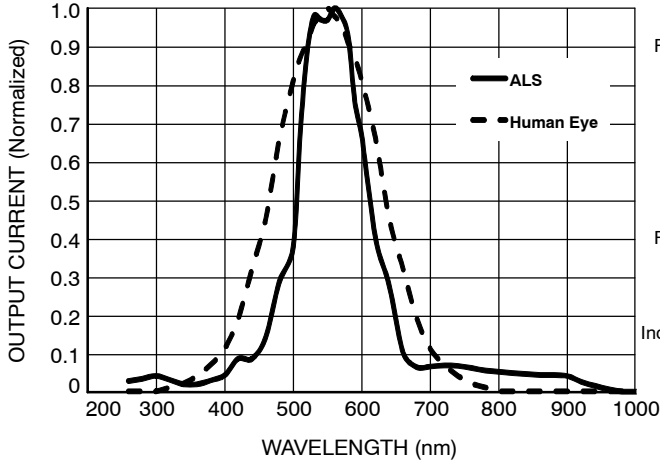

Figure 4. ALS Spectral Response (Normalized)

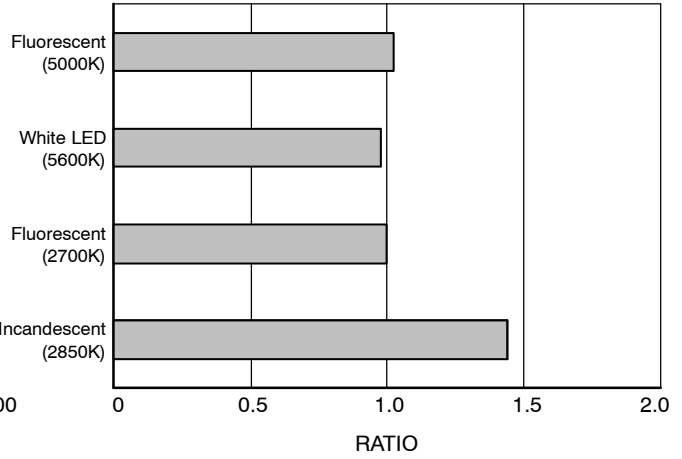

Figure 5. ALS Light Source Dependency (Normalized to Fluorescent Light)

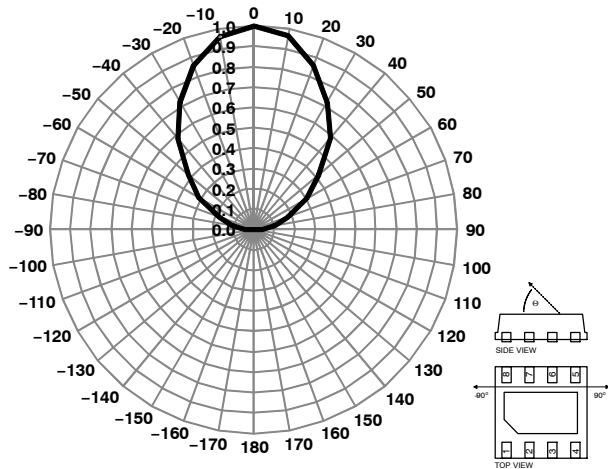

Figure 6. ALS Response to White Light vs. Angle

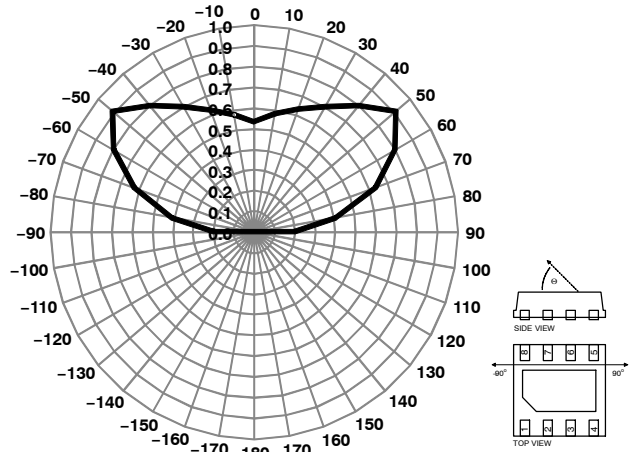

Figure 7. ALS Response to IR vs. Angle

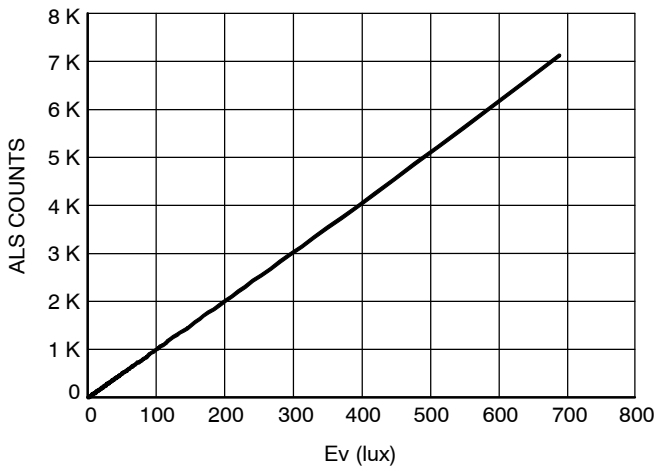

Figure 8. ALS Linearity 0-700 lux

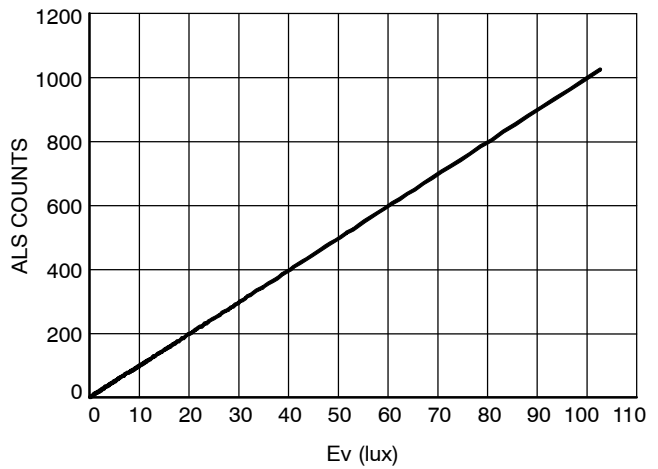

Figure 9. ALS Linearity 0-100 lux

TYPICAL CHARACTERISTICS

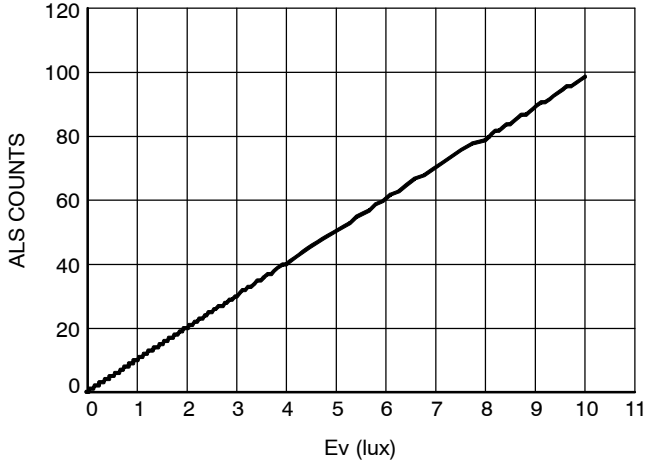

Figure 10. ALS Linearity 0-10 lux

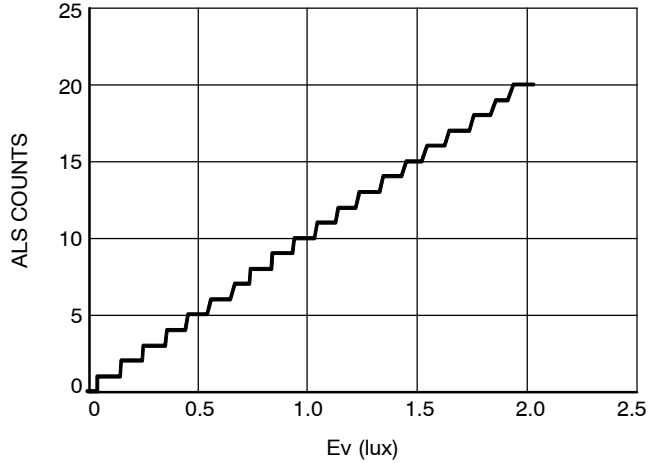

Figure 11. ALS Linearity 0-2 lux

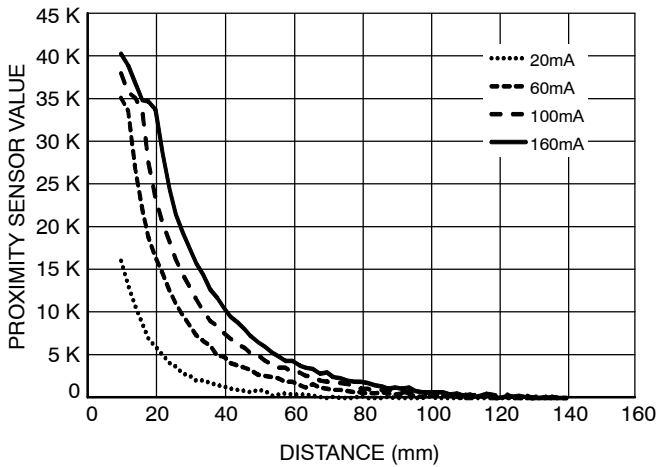

Figure 12. PS Response vs. Distance and LED Current (1200 μ s Integration Time, Grey Reflector (RGB = 162, 162, 160))

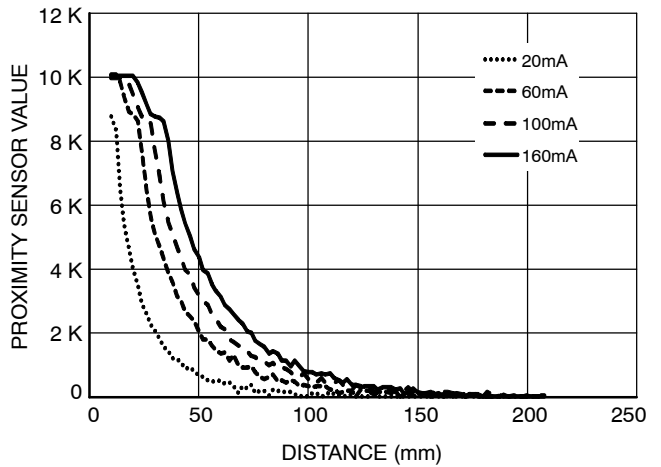

Figure 13. PS Response vs. Distance and LED Current (300 μ s Integration Time, White Reflector (RGB = 220, 224, 223))

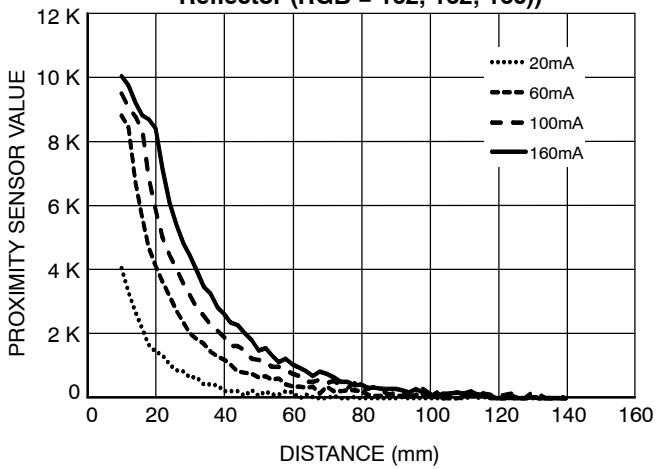

Figure 14. PS Response vs. Distance and LED Current (300 μ s Integration Time, Grey Reflector (RGB = 162, 162, 160))

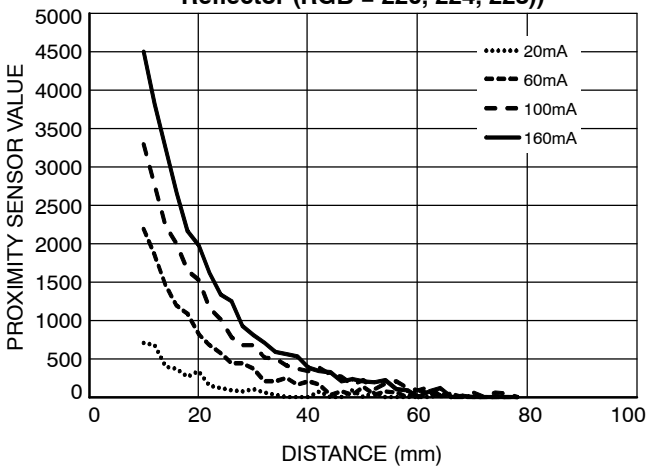

Figure 15. PS Response vs. Distance and LED Current (300 μ s Integration Time, Black Reflector (RGB = 16, 16, 15))

TYPICAL CHARACTERISTICS

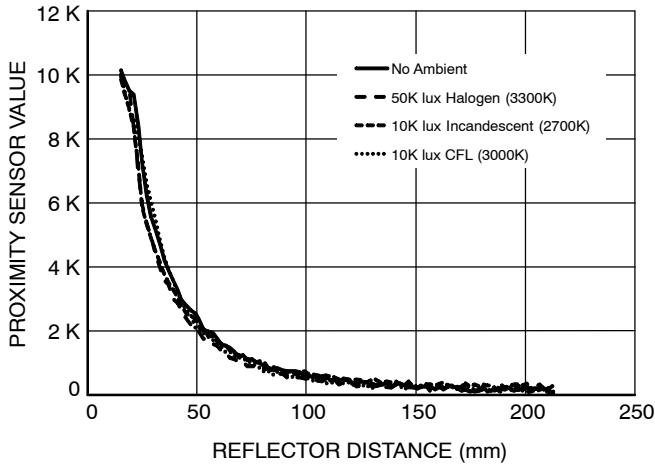

Figure 16. PS Ambient Rejection
 $T_{INT} = 300 \mu s$, $I_{LED} = 100 mA$, White Reflector
 (RGB = 220, 224, 223)

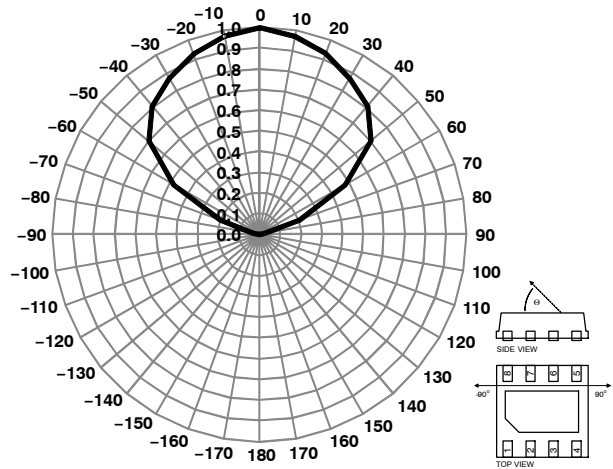

Figure 17. PS Response to IR vs. Angle

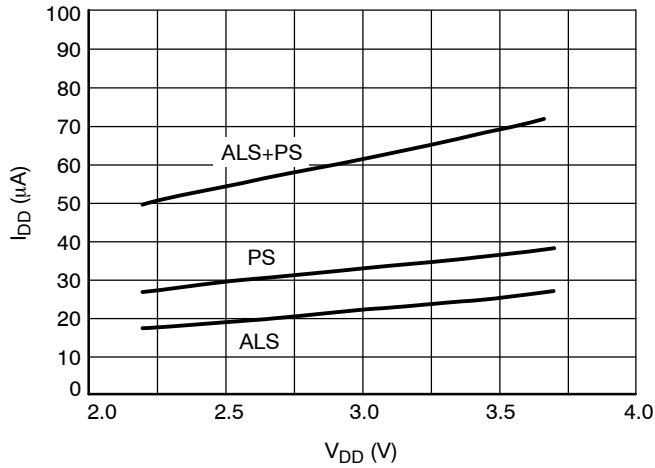

Figure 18. Supply Current vs. Supply Voltage
 ALS $T_{INT} = 100 ms$, $T_R = 500 ms$
 PS $T_{INT} = 300 \mu s$, $T_R = 100 ms$

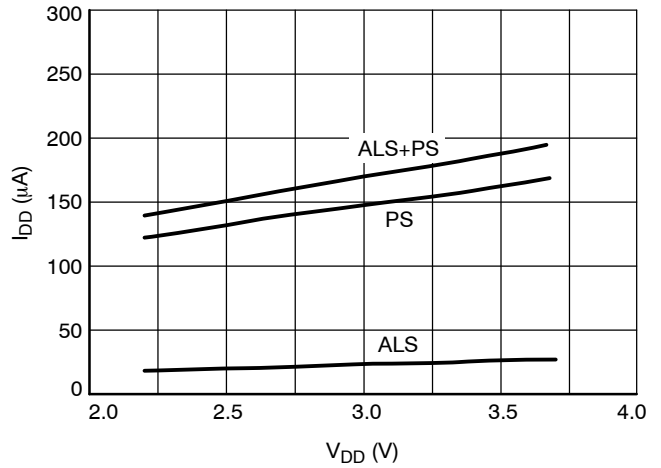

Figure 19. Supply Current vs. Supply Voltage
 ALS $T_{INT} = 100 ms$, $T_R = 500 ms$
 PS $T_{INT} = 1200 \mu s$, $T_R = 50 ms$

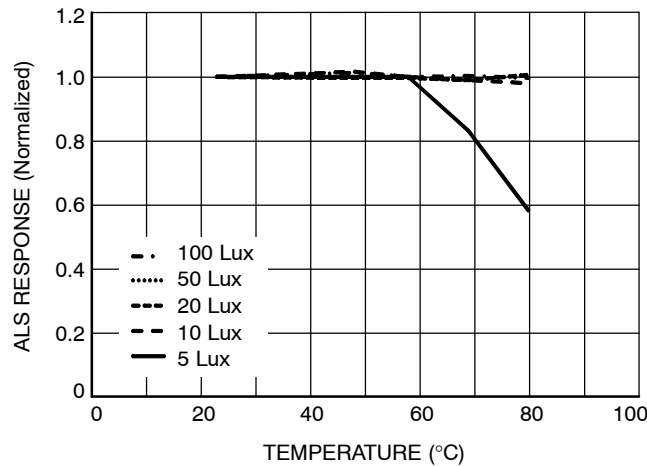

Figure 20. ALS Response vs. Temperature

DESCRIPTION OF OPERATION

Proximity Sensor Architecture

NOA3302 combines an advanced digital proximity sensor, LED driver, ambient light sensor and a tri-mode I²C interface as shown in Figure 1. The LED driver draws a modulated current through the external IR LED to illuminate the target. The LED current is programmable over a wide range. The infrared light reflected from the target is detected by the proximity sensor photo diode. The proximity sensor employs a sensitive photo diode fabricated in ON Semiconductor’s standard CMOS process technology. The modulated light received by the on-chip photodiode is converted to a digital signal using a variable slope integrating ADC with a default resolution (at 300 μs) of 13-bits, unsigned. The signal is processed to remove all unwanted signals resulting in a highly selective response to the generated light signal. The final value is stored in the PS_DATA register where it can be read by the I²C interface.

Ambient Light Sensor Architecture

The ambient light sensor contained in the NOA3302 employs a second photo diode with its own proprietary photopic filter limiting extraneous photons, and thus performing as a band pass filter on the incident wave front. The filter only transmits photons in the visible spectrum which are primarily detected by the human eye. The photo response of this sensor is as shown in Figure 4.

The ambient light signal detected by the photo diode is converted to digital signal using a variable slope integrating ADC with a resolution of 16-bits, unsigned. The ADC value is stored in the ALS_DATA register where it can be read by the I²C interface.

Equation 1 shows the relationship of output counts C_{nt} as a function of integration constant I_k, integration time T_{int} (in seconds) and the intensity of the ambient light, I_L (in lux), at room temperature (25°C).

$$I_L = C_{nt} / (I_k \cdot T_{int}) \tag{eq. 1}$$

Where:

$$I_k = 73 \text{ (for fluorescent light)}$$

$$I_k = 106 \text{ (for incandescent light)}$$

Hence the intensity of the ambient fluorescent light (in lux):

$$I_L = C_{nt} / (73 \cdot T_{int}) \tag{eq. 2}$$

and the intensity of the ambient incandescent light (in lux):

$$I_L = C_{nt} / (106 \cdot T_{int}) \tag{eq. 3}$$

For example let:

$$C_{nt} = 7300$$

$$T_{int} = 100 \text{ mS}$$

Intensity of ambient fluorescent light, I_L(in lux):

$$I_L = 7300 / (73 \cdot 100 \text{ mS}) \tag{eq. 4}$$

$$I_L = 1000 \text{ lux}$$

I²C Interface

The NOA3302 acts as an I²C slave device and supports single register and block register read and write operations. All data transactions on the bus are 8 bits long. Each data byte transmitted is followed by an acknowledge bit. Data is transmitted with the MSB first.

Figure 21 shows an I²C write operation. Write transactions begin with the master sending an I²C start sequence followed by the seven bit slave address (NOA3302 = 0x37) and the write(0) command bit. The NOA3302 will acknowledge this byte transfer with an appropriate ACK. Next the master will send the 8 bit register address to be written to. Again the NOA3302 will acknowledge reception with an ACK. Finally, the master will begin sending 8 bit data segment(s) to be written to the NOA3302 register bank. The NOA3302 will send an ACK after each byte and increment the address pointer by one in preparation for the next transfer. Write transactions are terminated with either an I²C STOP or with another I²C START (repeated START).

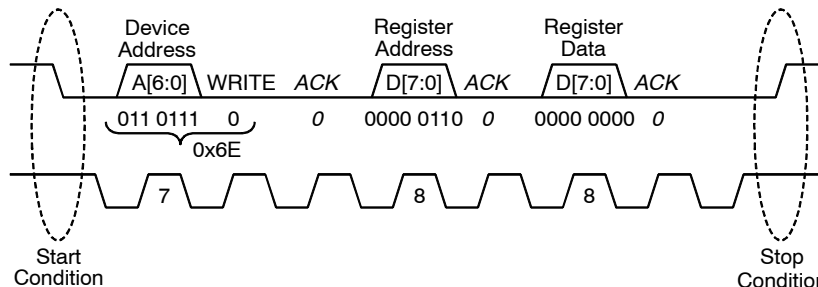

Figure 21. I²C Write Command

NOA3302

Figure 22 shows an I²C read command sent by the master to the slave device. Read transactions begin in much the same manner as the write transactions in that the slave address must be sent with a write(0) command bit.

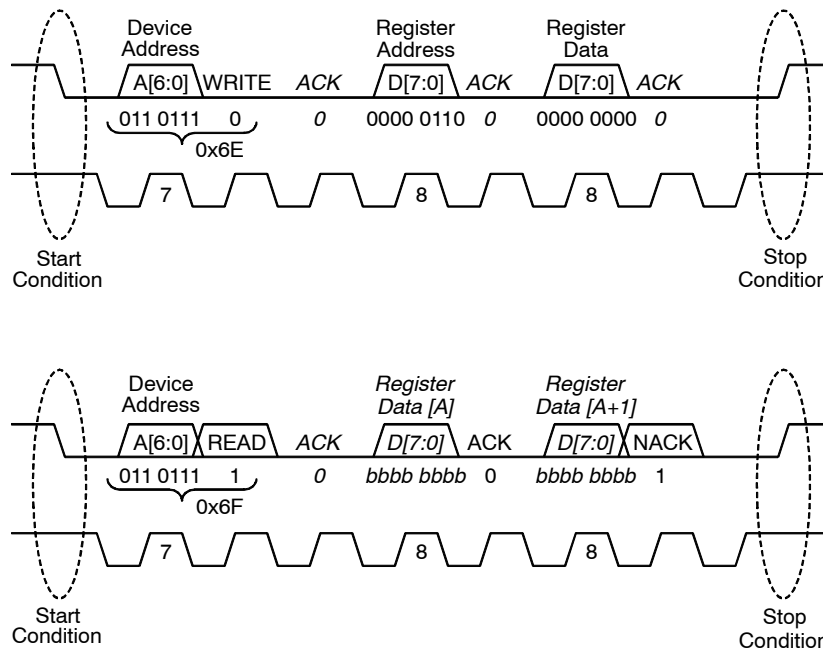

Figure 22. I²C Read Command

After the NOA3302 sends an ACK, the master sends the register address as if it were going to be written to. The NOA3302 will acknowledge this as well. Next, instead of sending data as in a write, the master will re-issue an I²C START (repeated start) and again send the slave address and this time the read(1) command bit. The NOA3302 will then begin shifting out data from the register just addressed. If the master wishes to receive more data (next register address), it will ACK the slave at the end of the 8 bit data transmission, and the slave will respond by sending the next byte, and so on. To signal the end of the read transaction, the master will send a NACK bit at the end of a transmission followed by an I²C STOP.

The NOA3302 also supports I²C high-speed mode. The transition from standard or fast mode to high-speed mode is initiated by the I²C master. A special reserve device address is called for and any device that recognizes this and supports high speed mode immediately changes the performance characteristics of its I/O cells in preparation for I²C transactions at the I²C high speed data protocol rates. From then on, standard I²C commands may be issued by the master, including repeated START commands. When the I²C master terminates any I²C transaction with a STOP sequence, the master and all slave devices immediately revert back to standard/fast mode I/O performance.

By using a combination of high-speed mode and a block write operation, it is possible to quickly initialize the NOA3302 I²C register bank.

NOA3302

NOA3302 Data Registers

NOA3302 operation is observed and controlled by internal data registers read from and written to via the external I²C interface. Registers are listed in Table 6. Default values are set on initial power up or via a software reset command (register 0x01).

The I²C slave address of the NOA3302 is 0x37.

Table 6. NOA3302 DATA REGISTERS

Address	Type	Name	Description
0x00	R	PART_ID	NOA3302 part number and revision IDs
0x01	RW	RESET	Software reset control
0x02	RW	INT_CONFIG	Interrupt pin functional control settings
0x0F	RW	PS_LED_CURRENT	PS LED pulse current (5, 10, ..., 160 mA)
0x10	RW	PS_TH_UP_MSB	PS Interrupt upper threshold, most significant bits
0x11	RW	PS_TH_UP_LSB	PS Interrupt upper threshold, least significant bits
0x12	RW	PS_TH_LO_MSB	PS Interrupt lower threshold, most significant bits
0x13	RW	PS_TH_LO_LSB	PS Interrupt lower threshold, least significant bits
0x14	RW	PS_FILTER_CONFIG	PS Filter configuration
0x15	RW	PS_CONFIG	PS Integration time configuration
0x16	RW	PS_INTERVAL	PS Interval time configuration
0x17	RW	PS_CONTROL	PS Operation mode control
0x20	RW	ALS_TH_UP_MSB	ALS Interrupt upper threshold, most significant bits
0x21	RW	ALS_TH_UP_LSB	ALS Interrupt upper threshold, least significant bits
0x22	RW	ALS_TH_LO_MSB	ALS Interrupt lower threshold, most significant bits
0x23	RW	ALS_TH_LO_LSB	ALS Interrupt lower threshold, least significant bits
0x24	RW	RESERVED	Reserved
0x25	RW	ALS_CONFIG	ALS Integration time configuration
0x26	RW	ALS_INTERVAL	ALS Interval time configuration
0x27	RW	ALS_CONTROL	ALS Operation mode control
0x40	R	INTERRUPT	Interrupt status
0x41	R	PS_DATA_MSB	PS measurement data, most significant bits
0x42	R	PS_DATA_LSB	PS measurement data, least significant bits
0x43	R	ALS_DATA_MSB	ALS measurement data, most significant bits
0x44	R	ALS_DATA_LSB	ALS measurement data, least significant bits

PART_ID Register (0x00)

The PART_ID register provides part and revision identification. These values are hard-wired at the factory and can not be modified.

Table 7. PART_ID REGISTER (0x00)

Bit	7	6	5	4	3	2	1	0
Field	Part number ID				Revision ID			

Field	Bit	Default	Description
Part number ID	7:4	1001	Part number identification
Revision ID	3:0	NA	Silicon revision number

NOA3302

RESET Register (0x01)

Software reset is controlled by this register. Setting this register followed by an I2C_STOP sequence will immediately reset the NOA3302 to the default startup

standby state. Triggering the software reset has virtually the same effect as cycling the power supply tripping the internal Power on Reset (POR) circuitry.

Table 8. RESET REGISTER (0x01)

Bit	7	6	5	4	3	2	1	0
Field	NA							SW_reset

Field	Bit	Default	Description
NA	7:1	XXXXXXX	Don't care
SW_reset	0	0	Software reset to startup state

INT_CONFIG Register (0x02)

INT_CONFIG register controls the external interrupt pin function.

Table 9. INT_CONFIG REGISTER (0x02)

Bit	7	6	5	4	3	2	1	0
Field	NA						auto_clear	polarity

Field	Bit	Default	Description	
NA	7:2	XXXXXX	Don't care	
auto_clear	1	1	0	When an interrupt is triggered, the interrupt pin remains asserted until cleared by an I ² C read of INTERRUPT register
			1	Interrupt pin state is updated after each measurement
polarity	0	0	0	Interrupt pin active low when asserted
			1	Interrupt pin active high when asserted

PS_LED_CURRENT Register (0x0F)

The LED_CURRENT register controls how much current the internal LED driver sinks through the IR LED during modulated illumination. The current sink range is a baseline

5 mA plus a binary weighted value of the LED_Current register times 5 mA, for an effective range of 5 mA to 160 mA in steps of 5 mA. The default setting is 50 mA.

Table 10. PS_LED_CURRENT REGISTER (0x0F)

Bit	7	6	5	4	3	2	1	0
Field	NA				LED_Current			

Field	Bit	Default	Description
NA	7:5	XXX	Don't care
LED_Current	4:0	01001	Defines current sink during LED modulation. Binary weighted value times 5 mA plus 5 mA.

PS_TH Registers (0x10 – 0x13)

With hysteresis not enabled (see PS_CONFIG register), the PS_TH registers set the upper and lower interrupt thresholds of the proximity detection window. Interrupt functions compare these threshold values to data from the PS_DATA registers. Measured PS_DATA values outside this window will set an interrupt according to the INT_CONFIG register settings.

With hysteresis enabled, threshold settings take on a different meaning. If PS_hyst_trig is set, the PS_TH_UP register sets the upper threshold at which an interrupt will be set, while the PS_TH_LO register then sets the lower

threshold hysteresis value where the interrupt would be cleared. Setting the PS_hyst_trig low reverses the function such that the PS_TH_LO register sets the lower threshold at which an interrupt will be set and the PS_TH_UP represents the hysteresis value at which the interrupt would be subsequently cleared. Hysteresis functions only apply in “auto_clear” INT_CONFIG mode.

The controller software must ensure the settings for LED current, sensitivity range, and integration time (LED pulses) are appropriate for selected thresholds. Setting thresholds to extremes (default) effectively disables interrupts.

Table 11. PS_TH_UP REGISTERS (0x10 – 0x11)

Bit	7	6	5	4	3	2	1	0
Field	PS_TH_UP_MSB(0x10), PS_TH_UP_LSB(0x11)							
Field	Bit	Default	Description					
PS_TH_UP_MSB	7:0	0xFF	Upper threshold for proximity detection, MSB					
PS_TH_UP_LSB	7:0	0xFF	Upper threshold for proximity detection, LSB					

Table 12. PS_TH_LO REGISTERS (0x12 – 0x13)

Bit	7	6	5	4	3	2	1	0
Field	PS_TH_LO_MSB(0x12), PS_TH_LO_LSB(0x13)							
Field	Bit	Default	Description					
PS_TH_LO_MSB	7:0	0x00	Lower threshold for proximity detection, MSB					
PS_TH_LO_LSB	7:0	0x00	Lower threshold for proximity detection, LSB					

PS_FILTER_CONFIG Register (0x14)

PS_FILTER_CONFIG register provides a hardware mechanism to filter out single event occurrences or similar anomalies from causing unwanted interrupts. Two 4 bit registers (M and N) can be set with values such that M out

of N measurements must exceed threshold settings in order to set an interrupt. The default setting of 1 out of 1 effectively turns the filter off and any single measurement exceeding thresholds can trigger an interrupt. (Note a setting of 0 is interpreted the same as a 1).

Table 13. PS_FILTER_CONFIG REGISTER (0x14)

Bit	7	6	5	4	3	2	1	0
Field	filter_N				filter_M			
Field	Bit	Default	Description					
filter_N	7:4	0001	Filter N					
filter_M	3:0	0001	Filter M					

PS_CONFIG Register (0x15)

Proximity measurement sensitivity is controlled by specifying the integration time. The integration time sets the number of LED pulses during the modulated illumination. The LED modulation frequency remains constant with a period of 1.5 μ s. Changing the integration time affects the

sensitivity of the detector and directly affects the power consumed by the LED. The default is 300 μ s integration period.

Hyst_enable and hyst_trigger work with the PS_TH (threshold) settings to provide jitter control of the INT function.

Table 14. PS_CONFIG REGISTER (0x15)

Bit	7	6	5	4	3	2	1	0
Field	NA		hyst_enable	hyst_trigger	NA		integration_time	
Field	Bit	Default	Description					
NA	7:6	XX	Don't Care					
hyst_enable	5	0	0	Disables hysteresis				
			1	Enables hysteresis				
hyst_trigger	4	0	0	Lower threshold with hysteresis				
			1	Upper threshold with hysteresis				
NA	3:2	X	Don't Care					
integration_time	1:0	01	00	150 μ s integration time				
			01	300 μ s integration time				
			10	600 μ s integration time				
			11	1200 μ s integration time				

PS_INTERVAL Register (0x16)

The PS_INTERVAL register sets the wait time between consecutive proximity measurements in PS_Repeat mode. The register is binary weighted times 5 in milliseconds with

the special case that the register value 0x00 specifies 5 ms. The range is therefore 5 ms to 1.28 s. The default startup value is 0x0A (50 ms).

Table 15. PS_INTERVAL REGISTER (0x16)

Bit	7	6	5	4	3	2	1	0
Field	interval							

Field	Bit	Default	Description
Interval	7:0	0x0A	0x01 to 0xFF Interval time between measurement cycles. Binary weighted value times 5 ms plus a 5 ms offset.

PS_CONTROL Register (0x17)

The PS_CONTROL register is used to control the functional mode and commencement of proximity sensor measurements. The proximity sensor can be operated in either a single shot mode or consecutive measurements taken at programmable intervals.

Both single shot and repeat modes consume a minimum of power by immediately turning off LED driver and sensor circuitry after each measurement. In both cases the quiescent current is less than the IDD_{STBY} parameter. These automatic power management features eliminate the need for power down pins or special power down instructions.

Table 16. PS_CONTROL REGISTER (0x17)

Bit	7	6	5	4	3	2	1	0
Field	NA						PS_Repeat	PS_OneShot

Field	Bit	Default	Description
NA	7:2	XXXXXX	Don't care
PS_Repeat	1	0	Initiates new measurements at PS_Interval rates
PS_OneShot	0	0	Triggers proximity sensing measurement. In single shot mode this bit clears itself after cycle completion.

ALS_TH Registers (0x20 – 0x23)

With hysteresis not enabled (see ALS_CONFIG register), the ALS_TH registers set the upper and lower interrupt thresholds of the ambient light detection window. Interrupt functions compare these threshold values to data from the ALS_DATA registers. Measured ALS_DATA values outside this window will set an interrupt according to the INT_CONFIG register settings.

With hysteresis enabled, threshold settings take on a different meaning. If the ALS_hyst_trig is set, the

ALS_TH_UP register sets the upper threshold at which an interrupt will be set, while the ALS_TH_LO register then sets the lower threshold hysteresis value where the interrupt would be cleared. Setting the ALS_hyst_trig low reverses the function such that the ALS_TH_LO register sets the lower threshold at which an interrupt will be set and the ALS_TH_UP represents the hysteresis value at which the interrupt would be subsequently cleared. Hysteresis functions only apply in “auto_clear” INT_CONFIG mode.

Table 17. ALS_TH_UP REGISTERS (0x20 – 0x21)

Bit	7	6	5	4	3	2	1	0
Field	ALS_TH_UP_MSB(0x20), ALS_TH_UP_LSB(0x21)							

Field	Bit	Default	Description
ALS_TH_UP_MSB	7:0	0xFF	Upper threshold for ALS detection, MSB
ALS_TH_UP_LSB	7:0	0xFF	Upper threshold for ALS detection, LSB

NOA3302

Table 18. ALS_TH_LO REGISTERS (0x22 – 0x23)

Bit	7	6	5	4	3	2	1	0
Field	ALS_TH_LO_MSB(0x22), ALS_TH_LO_LSB(0x23)							
Field	Bit	Default	Description					
ALS_TH_LO_MSB	7:0	0x00	Lower threshold for ALS detection, MSB					
ALS_TH_LO_LSB	7:0	0x00	Lower threshold for ALS detection, LSB					

ALS_CONFIG Register (0x25)

The ALS_CONFIG register controls the ambient light measurement sensitivity by specifying the integration time. Hyst_enable and hyst_trigger work with the ALS_TH (threshold) settings to provide jitter control of the INT function.

Integration times below 50 ms are not recommended for normal operation as 50/60 Hz rejection will be impacted. They may be used in testing or if 50/60 Hz rejection is not a concern.

Table 19. ALS_CONFIG REGISTER (0x25)

Bit	7	6	5	4	3	2	1	0
Field	NA		hyst_enable	hyst_trigger	reserved	integration_time		
Field	Bit	Default	Description					
NA	7:6	XX	Don't Care					
hyst_enable	5	0	0	Disables hysteresis				
			1	Enables hysteresis				
hyst_trigger	4	0	0	Lower threshold with hysteresis				
			1	Upper threshold with hysteresis				
reserved	3	0	Must be set to 0					
integration_time	2:0	100	000	6.25 ms integration time				
			001	12.5 ms integration time				
			010	25 ms integration time				
			011	50 ms integration time				
			100	100 ms integration time				
			101	200 ms integration time				
			110	400 ms integration time				
			111	800 ms integration time				

ALS_INTERVAL Register (0x26)

The ALS_INTERVAL register sets the interval between consecutive ALS measurements in ALS_Repeat mode. The register is binary weighted times 50 in milliseconds. The

range is 0 ms to 3.15 s. The register value 0x00 and 0 ms translates into a continuous loop measurement mode at any integration time. The default startup value is 0x0A (500 ms).

Table 20. ALS_INTERVAL REGISTER (0x26)

Bit	7	6	5	4	3	2	1	0
Field	interval							
Field	Bit	Default	Description					
interval	5:0	0x0A	Interval time between ALS measurement cycles					

ALS_CONTROL Register (0x27)

The ALS_CONTROL register is used to control the functional mode and commencement of ambient light sensor measurements. The ambient light sensor can be operated in either a single shot mode or consecutive measurements taken at programmable intervals.

Both single shot and repeat modes consume a minimum of power by immediately turning off sensor circuitry after

each measurement. In both cases the quiescent current is less than the IDD_{STBY} parameter. These automatic power management features eliminate the need for power down pins or special power down instructions.

For accurate measurements at low light levels (below approximately 3 lux) ALS readings must be taken at least once per second and the first measurement after a reset (software reset or power cycling) should be ignored.

Table 21. ALS_CONTROL REGISTER (0x27)

Bit	7	6	5	4	3	2	1	0
Field	NA					ALS_Repeat		ALS_OneShot

Field	Bit	Default	Description
NA	7:2	XXXXXX	Don't care
ALS_Repeat	1	0	Initiates new measurements at ALS_Interval rates
ALS_OneShot	0	0	Triggers ALS sensing measurement. In single shot mode this bit clears itself after cycle completion.

INTERRUPT Register (0x40)

The INTERRUPT register displays the status of the interrupt pin and if an interrupt was caused by the proximity or ambient light sensor. If “auto_clear” is disabled (see INT_CONFIG register), reading this register also will clear the interrupt.

Table 22. INTERRUPT REGISTER (0x40)

Bit	7	6	5	4	3	2	1	0
Field	NA			INT	ALS_intH	ALS_intL	PS_intH	PS_intL

Field	Bit	Default	Description
NA	7:5	XXX	Don't care
INT	4	0	Status of external interrupt pin (1 is asserted)
ALS_intH	3	0	Interrupt caused by ALS exceeding maximum
ALS_intL	2	0	Interrupt caused by ALS falling below the minimum
PS_intH	1	0	Interrupt caused by PS exceeding maximum
PS_intL	0	0	Interrupt caused by PS falling below the minimum

PS_DATA Registers (0x41 – 0x42)

The PS_DATA registers store results from completed proximity measurements. When an I²C read operation begins, the current PS_DATA registers are locked until the

operation is complete (I2C_STOP received) to prevent possible data corruption from a concurrent measurement cycle.

Table 23. PS_DATA REGISTERS (0x41 – 0x42)

Bit	7	6	5	4	3	2	1	0
Field	PS_DATA_MSB(0x41), PS_DATA_LSB(0x42)							

Field	Bit	Default	Description
PS_DATA_MSB	7:0	0x00	Proximity measurement data, MSB
PS_DATA_LSB	7:0	0x00	Proximity measurement data, LSB

NOA3302

ALS_DATA Registers (0x43 – 0x44)

The ALS_DATA registers store results from completed ALS measurements. When an I²C read operation begins, the current ALS_DATA registers are locked until the operation

is complete (I2C_STOP received) to prevent possible data corruption from a concurrent measurement cycle.

Table 24. ALS_DATA REGISTERS (0x43 – 0x44)

Bit	7	6	5	4	3	2	1	0
Field	ALS_DATA_MSB(0x43), ALS_DATA_LSB(0x44)							

Field	Bit	Default	Description
ALS_DATA_MSB	7:0	0x00	ALS measurement data, MSB
ALS_DATA_LSB	7:0	0x00	ALS measurement data, LSB

Proximity Sensor Operation

NOA3302 operation is divided into three phases: power up, configuration and operation. On power up the device initiates a reset which initializes the configuration registers to their default values and puts the device in the standby state. At any time, the host system may initiate a software reset by writing 0x01 to register 0x01. A software reset performs the same function as a power-on-reset.

The configuration phase may be skipped if the default register values are acceptable, but typically it is desirable to change some or all of the configuration register values. Configuration is accomplished by writing the desired configuration values to registers 0x02 through 0x17. Writing to configuration registers can be done with either individual I²C byte-write commands or with one or more I²C block write commands. Block write commands specify the first register address and then write multiple bytes of data in sequence. The NOA3302 automatically increments the register address as it acknowledges each byte transfer.

Proximity sensor measurement is initiated by writing appropriate values to the CONTROL register (0x17).

Sending an I2C_STOP sequence at the end of the write signals the internal state machines to wake up and begin the next measurement cycle. Figures 23 and 24 illustrate the activity of key signals during a proximity sensor measurement cycle. The cycle begins by starting the precision oscillator and powering up and calibrating the proximity sensor receiver. Next, the IR LED current is modulated according to the LED current setting at the chosen LED frequency and the values during both the on and off times of the LED are stored (illuminated and ambient values). Finally, the proximity reading is calculated by subtracting the ambient value from the illuminated value and storing the result in the 16 bit PS_Data register. In One-shot mode, the PS receiver is then powered down and the oscillator is stopped (unless there is an active ALS measurement). If Repeat mode is set, the PS receiver is powered down for the specified interval and the process is repeated. With default configuration values (receiver integration time = 300 μs), the total measurement cycle will be less than 2 ms.

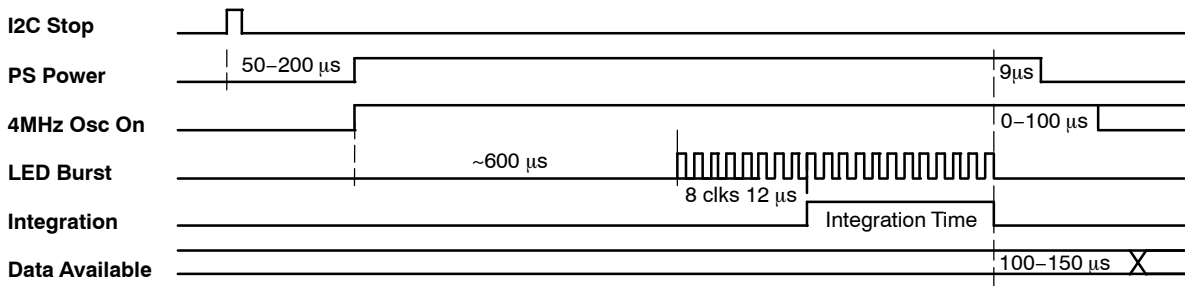

Figure 23. Proximity Sensor One-Shot Timing

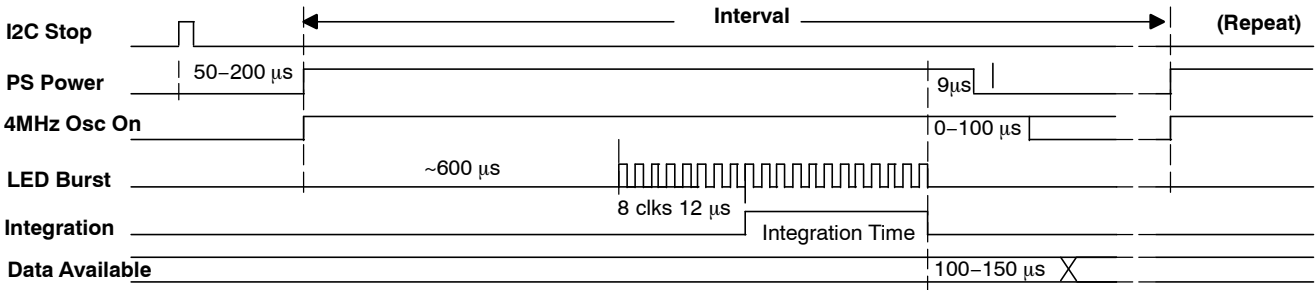

Figure 24. Proximity Sensor Repeat Timing

Ambient Light Sensor Operation

The ALS configuration is accomplished by writing the desired configuration values to registers 0x02 and 0x20 through 0x27. Writing to configuration registers can be done with either individual I²C byte-write commands or with one or more I²C block write commands. Block write commands specify the first register address and then write multiple bytes of data in sequence. The NOA3302 automatically increments the register address as it acknowledges each byte transfer.

ALS measurement is initiated by writing appropriate values to the CONTROL register (0x27). Sending an I²C_STOP sequence at the end of the write signals the internal state machines to wake up and begin the next measurement cycle. Figures 25 and 26 illustrate the activity of key signals during an ambient light sensor measurement

cycle. The cycle begins by starting the precision oscillator and powering up the ambient light sensor. Next, the ambient light measurement is made for the specified integration time and the result is stored in the 16 bit ALS Data register. If in One-shot mode, the ALS is powered down and awaits the next command. If in Repeat mode the ALS is powered down, the interval is timed out and the operation repeated. There are some special cases if the interval timer is set to less than the integration time. For continuous mode, the interval is set to 0 and the ALS makes continuous measurements with only a 5 μs delay between integration times and the ALS remains powered up. If the interval is set equal to or less than the integration time (but not to 0), there is a 10 ms time between integrations and the ALS remains powered up.

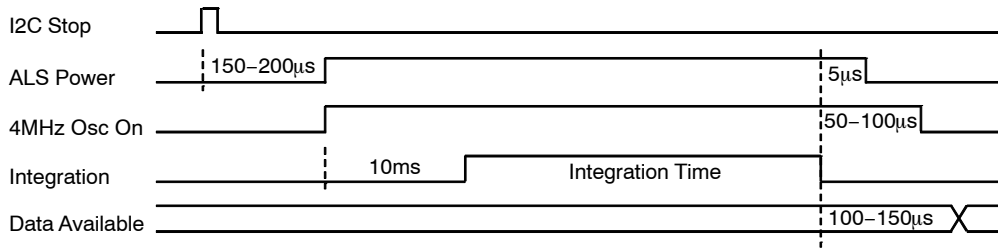

Figure 25. ALS One-Shot Timing

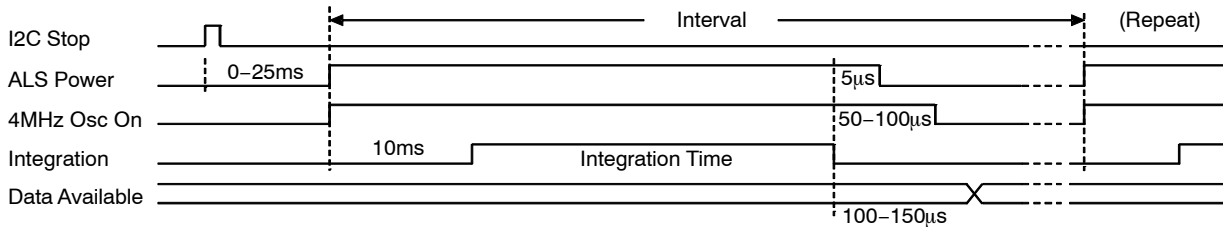

Figure 26. ALS Repeat Timing

NOTE: If Interval is set to 0 (continuous) the time between integrations is 5 μs and power stays on.
 If Interval is set to ≤ to the integration time (but not 0) the time between integrations is 10 ms and power stays on.
 If Interval is set to > integration time the time between integrations is the interval and the ALS powers down.

Example Programming Sequence

The following pseudo code configures the NOA3302 proximity sensor in repeat mode with 50 ms wait time between each measurement and then runs it in an interrupt driven mode. When the controller receives an interrupt, the interrupt determines if the interrupts was caused by the proximity sensor and if so, reads the PS_Data from the device, sets a flag and then waits for the main polling loop to respond to the proximity change.

```
external subroutine I2C_Read_Byte (I2C_Address, Data_Address);
external subroutine I2C_Read_Block (I2C_Address, Data_Start_Address, Count, Memory_Map);
external subroutine I2C_Write_Byte (I2C_Address, Data_Address, Data);
external subroutine I2C_Write_Block (I2C_Address, Data_Start_Address, Count, Memory_Map);
subroutine Initialize_PS () {
  MemBuf[0x02] = 0x02; // INT_CONFIG assert interrupt until cleared
  MemBuf[0x0F] = 0x09; // PS_LED_CURRENT 50mA
  MemBuf[0x10] = 0x8F; // PS_TH_UP_MSB
  MemBuf[0x11] = 0xFF; // PS_TH_UP_LSB
  MemBuf[0x12] = 0x70; // PS_TH_LO_MSB
  MemBuf[0x13] = 0x00; // PS_TH_LO_LSB
  MemBuf[0x14] = 0x11; // PS_FILTER_CONFIG turn off filtering
  MemBuf[0x15] = 0x01; // PS_CONFIG 300us integration time
  MemBuf[0x16] = 0x0A; // PS_INTERVAL 50ms wait
  MemBuf[0x17] = 0x02; // PS_CONTROL enable continuous PS measurements
  MemBuf[0x20] = 0xFF; // ALS_TH_UP_MSB
  MemBuf[0x21] = 0xFF; // ALS_TH_UP_LSB
  MemBuf[0x22] = 0x00; // ALS_TH_LO_MSB
  MemBuf[0x23] = 0x00; // ALS_TH_LO_LSB
  MemBuf[0x25] = 0x04; // ALS_CONFIG 100ms integration time
  MemBuf[0x26] = 0x00; // ALS_INTERVAL continuous measurement mode
  MemBuf[0x27] = 0x02; // ALS_CONTROL enable continuous ALS measurements
  I2C_Write_Block (I2CAddr, 0x02, 37, MemBuf);
}
subroutine I2C_Interupt_Handler () {
  // Verify this is a PS interrupt
  INT = I2C_Read_Byte (I2CAddr, 0x40);
  if (INT == 0x11 || INT == 0x12) {
    // Retrieve and store the PS data
    PS_Data_MSB = I2C_Read_Byte (I2CAddr, 0x41);
    PS_Data_LSB = I2C_Read_Byte (I2CAddr, 0x42);
    NewPS = 0x01;
  }
}
subroutine main_loop () {
  I2CAddr = 0x37;
  NewPS = 0x00;
  Initialize_PS ();
  loop {
    // Do some other polling operations
    if (NewPS == 0x01) {
      NewPS = 0x00;
      // Do some operations with PS_Data
    }
  }
}
```

NOA3302

Physical Location of Photodiode Sensors

The physical locations of the NOA3302 proximity sensor and ambient light sensor photodiodes are shown in Figure 27.

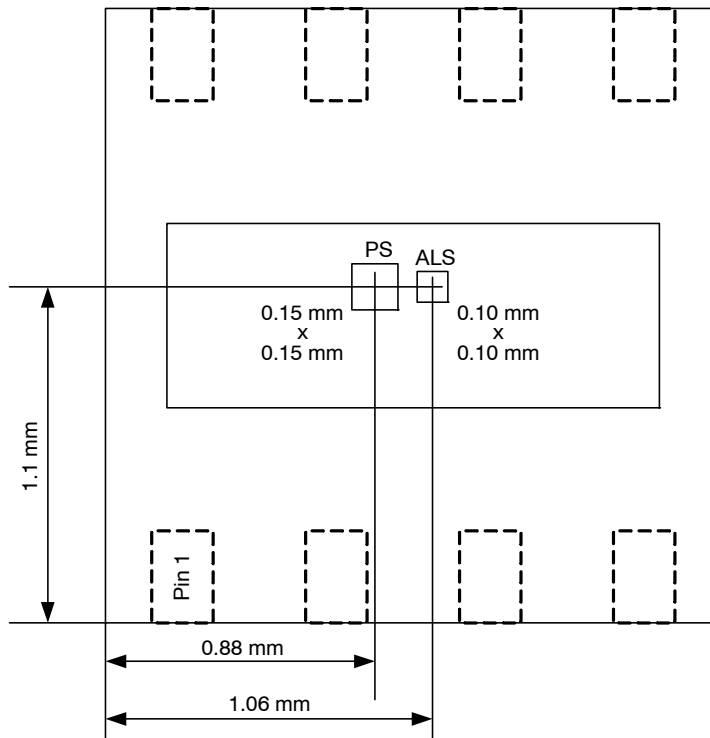
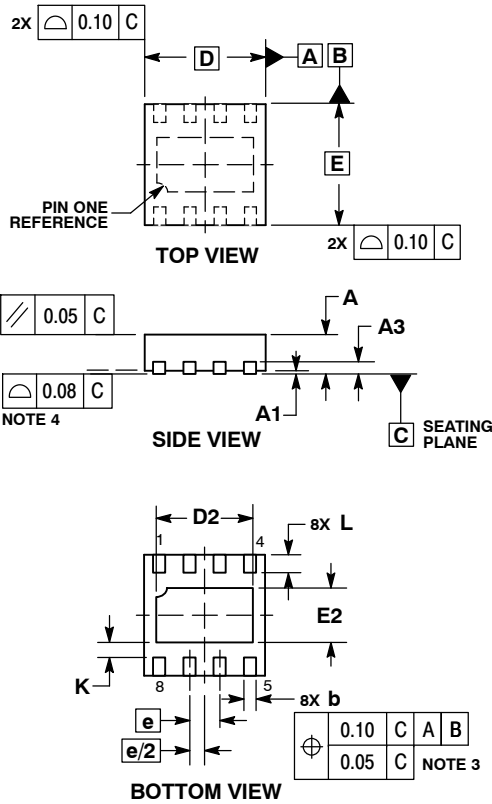

Figure 27. Photodiode Locations

NOA3302

PACKAGE DIMENSIONS

CWDFN8, 2x2, 0.5P CASE 505AJ ISSUE O



NOTES:

1. DIMENSIONING AND TOLERANCING PER ASME Y14.5M, 1994.
2. CONTROLLING DIMENSION: MILLIMETERS.
3. DIMENSION b APPLIES TO PLATED TERMINAL AND IS MEASURED BETWEEN 0.10 AND 0.20 MM FROM THE TERMINAL TIP.
4. COPLANARITY APPLIES TO THE EXPOSED PAD AS WELL AS THE TERMINALS.

DIM	MILLIMETERS	
	MIN	MAX
A	0.60	0.70
A1	0.00	0.05
A3	0.20 REF	
b	0.15	0.25
D	2.00 BSC	
D2	1.45	1.70
E	2.00 BSC	
E2	0.75	1.00
e	0.50 BSC	
K	0.15	---
L	0.20	0.40

RECOMMENDED MOUNTING FOOTPRINT*

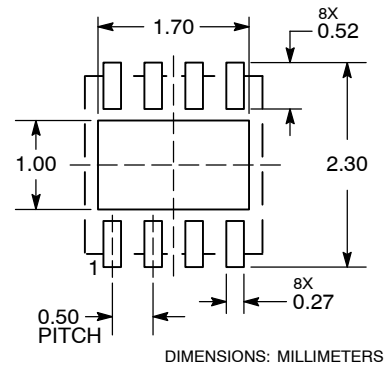

*For additional information on our Pb-Free strategy and soldering details, please download the ON Semiconductor Soldering and Mounting Techniques Reference Manual, SOLDERRM/D.

ON Semiconductor and are registered trademarks of Semiconductor Components Industries, LLC (SCILLC). SCILLC owns the rights to a number of patents, trademarks, copyrights, trade secrets, and other intellectual property. A listing of SCILLC's product/patent coverage may be accessed at www.onsemi.com/site/pdf/Patent-Marking.pdf. SCILLC reserves the right to make changes without further notice to any products herein. SCILLC makes no warranty, representation or guarantee regarding the suitability of its products for any particular purpose, nor does SCILLC assume any liability arising out of the application or use of any product or circuit, and specifically disclaims any and all liability, including without limitation special, consequential or incidental damages. "Typical" parameters which may be provided in SCILLC data sheets and/or specifications can and do vary in different applications and actual performance may vary over time. All operating parameters, including "Typicals" must be validated for each customer application by customer's technical experts. SCILLC does not convey any license under its patent rights nor the rights of others. SCILLC products are not designed, intended, or authorized for use as components in systems intended for surgical implant into the body, or other applications intended to support or sustain life, or for any other application in which the failure of the SCILLC product could create a situation where personal injury or death may occur. Should Buyer purchase or use SCILLC products for any such unintended or unauthorized application, Buyer shall indemnify and hold SCILLC and its officers, employees, subsidiaries, affiliates, and distributors harmless against all claims, costs, damages, and expenses, and reasonable attorney fees arising out of, directly or indirectly, any claim of personal injury or death associated with such unintended or unauthorized use, even if such claim alleges that SCILLC was negligent regarding the design or manufacture of the part. SCILLC is an Equal Opportunity/Affirmative Action Employer. This literature is subject to all applicable copyright laws and is not for resale in any manner.

PUBLICATION ORDERING INFORMATION

LITERATURE FULFILLMENT:
Literature Distribution Center for ON Semiconductor
P.O. Box 5163, Denver, Colorado 80217 USA
Phone: 303-675-2175 or 800-344-3860 Toll Free USA/Canada
Fax: 303-675-2176 or 800-344-3867 Toll Free USA/Canada
Email: orderlit@onsemi.com

N. American Technical Support: 800-282-9855 Toll Free
USA/Canada
Europe, Middle East and Africa Technical Support:
Phone: 421 33 790 2910
Japan Customer Focus Center
Phone: 81-3-5817-1050

ON Semiconductor Website: www.onsemi.com
Order Literature: <http://www.onsemi.com/orderlit>

For additional information, please contact your local Sales Representative