

## Peak Emission Wavelength: 850nm

The 850nm Point Source Series is designed for applications requiring high accuracy and precision as well as uniform spectral emission. Custom package solutions and sorting are available.

### FEATURES

- > Hermetically Sealed TO-46
- > Emitting Window Diameter  $\Phi$  50 $\mu$ m
- > Gold Plated Flat Top Can
- > High Reliability / High Output Power

### APPLICATIONS

- > Optical Scanning
- > Linear & Rotary Encoder
- > Edge Sensing
- > Optical Sensors



## Absolute Maximum Ratings (Ta=25°C)



ITEMS	SYMBOL	RATINGS	UNIT
Forward Current (DC)	IF	80	mA
Forward Current (Pulse)*1	IFP	0.4	A
Reverse Voltage	VR	5	V
Power Dissipation	PD	130	mW
Operating Temperature Range	Topr	-25 ~ +85	°C
Storage Temperature Range	Tstg	-30 ~ +100	°C
Junction Temperature	Tj	125	°C
Lead Soldering Temperature*2	Tls	260	°C

\*1: Tw=10 $\mu$ sec, T=10msec; \*2: Time 5 Sec max, Position: Up to 3mm from the body.

## Electrical & Optical Characteristics (Ta = 25°C)

ITEMS	SYMBOL	CONDITIONS	MIN	TYP	MAX	UNIT
Power Output	PO	IF=50mA	1.6	2.1	--	mW
Forward Voltage	VF	IF=50mA	--	2.0	2.4	V
Reverse Current	IR	VR=5V	--	--	10	$\mu$ A
Peak Emission Wavelength	$\lambda_p$	IF=50mA	--	850	--	nm
Spectral Line Half Width	$\Delta\lambda$	IF=50mA	--	40	--	nm
Half Intensity Beam Angle	$\Theta$	IF=50mA	--	$\pm 45$	--	deg

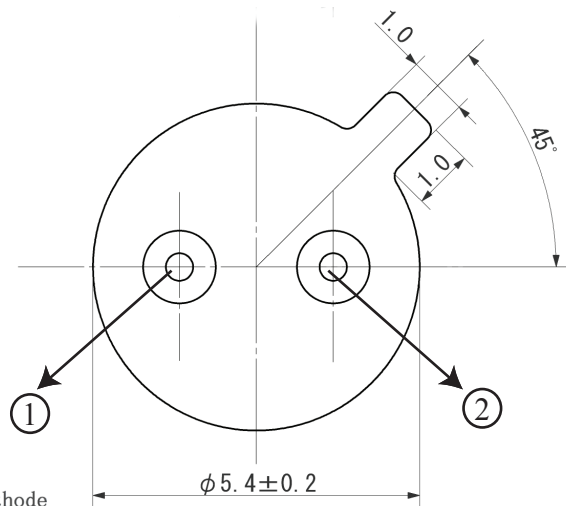
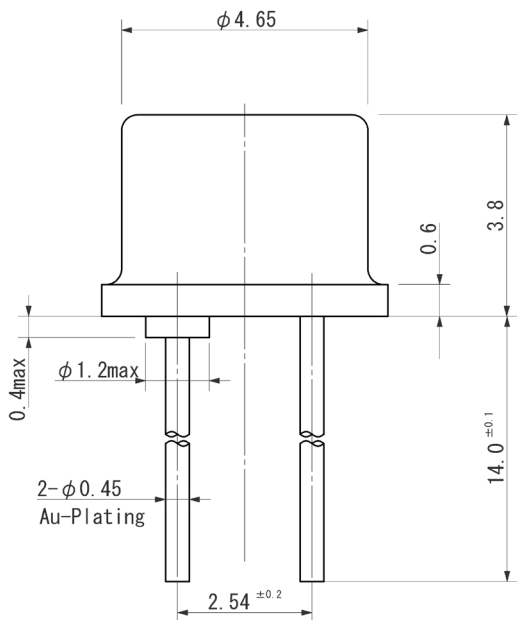

①Cathode  
②Anode

Unit: mm, Tolerance:  $\pm 0.2$

The information contained herein is subject to change without notice.

2012-01-18