



FEATURES

- RoHS compliant
- Up to 2.52A I_{DC}
- 10μH to 68mH
- Low DC resistance
- Surface mount
- Compact size
- Tape and reel packaging
- Compatible with RoHS soldering systems
- Backward compatible with Sn/Pb soldering systems
- Custom parts available

DESCRIPTION

The 2200RM Series is a surface mount alternative to our 2200R Series. It is a general purpose range of inductors suitable for low to medium current applications. Their small footprint makes them ideal for high density applications where a chip inductor will not cope with the power requirement.

SELECTION GUIDE

Order Code	Inductance, (1kHz, 0.1V _{AC})	DC Current ¹	DC Resistance
	±10% μH	Max. A	Max. Ω
22R103MC	10.0	2.52	0.05
22R153MC	15.0	2.08	0.07
22R223MC	22.0	1.81	0.09
22R333MC	33.0	1.31	0.14
22R473MC	47.0	0.99	0.22
22R683MC	68.0	0.84	0.28
22R104MC	100.0	0.80	0.39
22R154MC	150.0	0.64	0.54
22R224MC	220.0	0.50	0.83
22R334MC	330.0	0.42	1.21
22R474MC	470.0	0.37	1.65
22R684MC	680.0	0.30	2.64
22R105MC	1.0mH	0.21	3.63
22R155MC	1.5mH	0.16	6.49
22R225MC	2.2mH	0.14	8.58
22R335MC	3.3mH	0.12	10.0
22R475MC	4.7mH	0.10	13.2
22R685MC	6.8mH	0.077	22.0
22R106MC	10.0mH	0.068	37.4
22R156MC	15.0mH	0.055	49.5
22R226MC	22.0mH	0.044	82.5
22R336MC	33.0mH	0.037	110.0
22R476MC	47.0mH	0.033	154.0
22R686MC	68.0mH	0.026	242.0

ABSOLUTE MAXIMUM RATINGS

Operating free air temperature range	-40°C to 85°C
Storage temperature range	-40°C to 150°C

SOLDERING INFORMATION²

Peak reflow temperature	250°C
Pin finish	Hot dipped tin

PACKAGE SPECIFICATIONS

Mechanical Dimensions

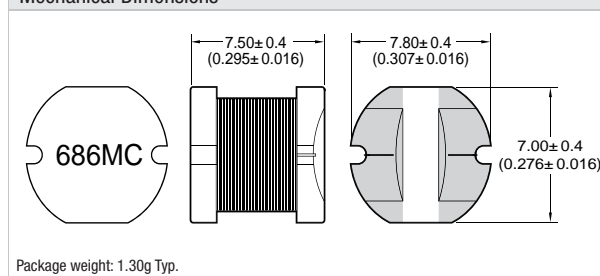

Unless otherwise stated, all dimensions in mm (inches) ± 0.25 (0.010).

Recommended Pad Layout

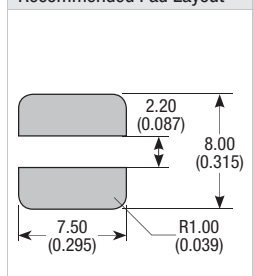

All specifications typical at T_a=25°C

- 1 Maximum DC current occurs when either the inductance falls to 90% of its nominal value or when its temperature rise reaches 30°C, whichever is sooner.
- 2 For further information, please visit www.murata-ps.com/rohs



INDUCTANCE Vs CURRENT

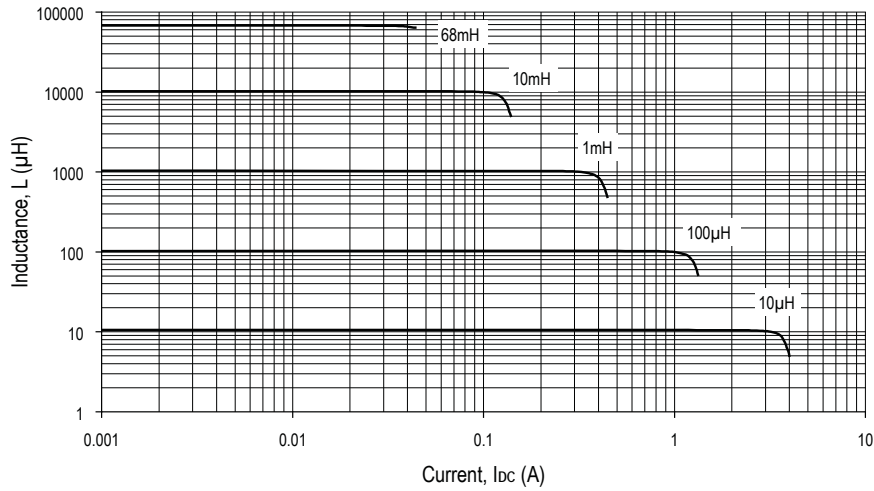

TEMPERATURE Vs CURRENT

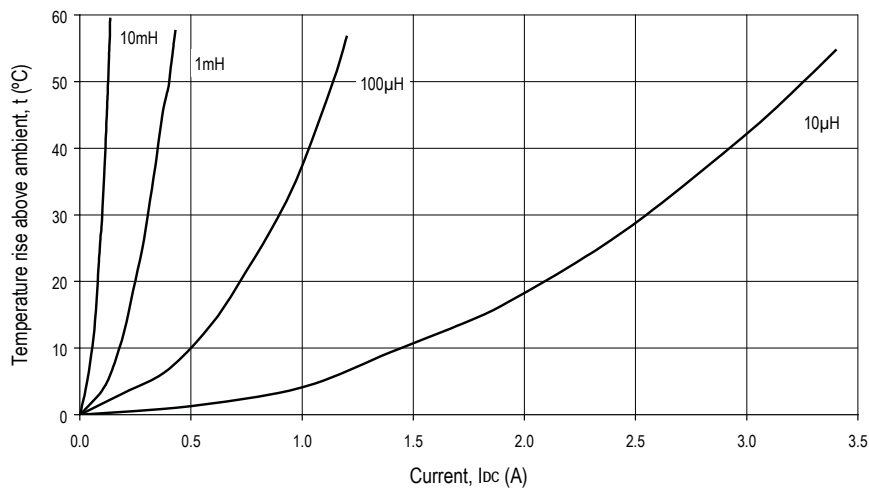

INDUCTANCE Vs FREQUENCY

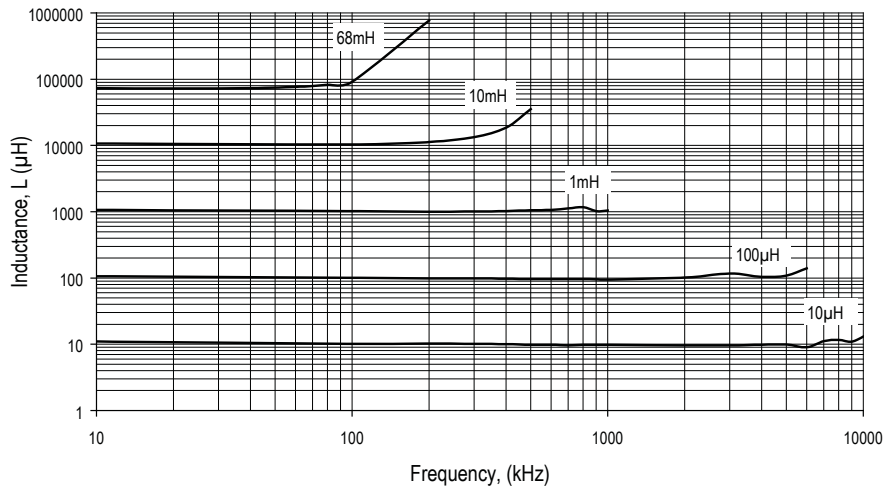

TAPE & REEL SPECIFICATIONS

REEL OUTLINE DIMENSIONS

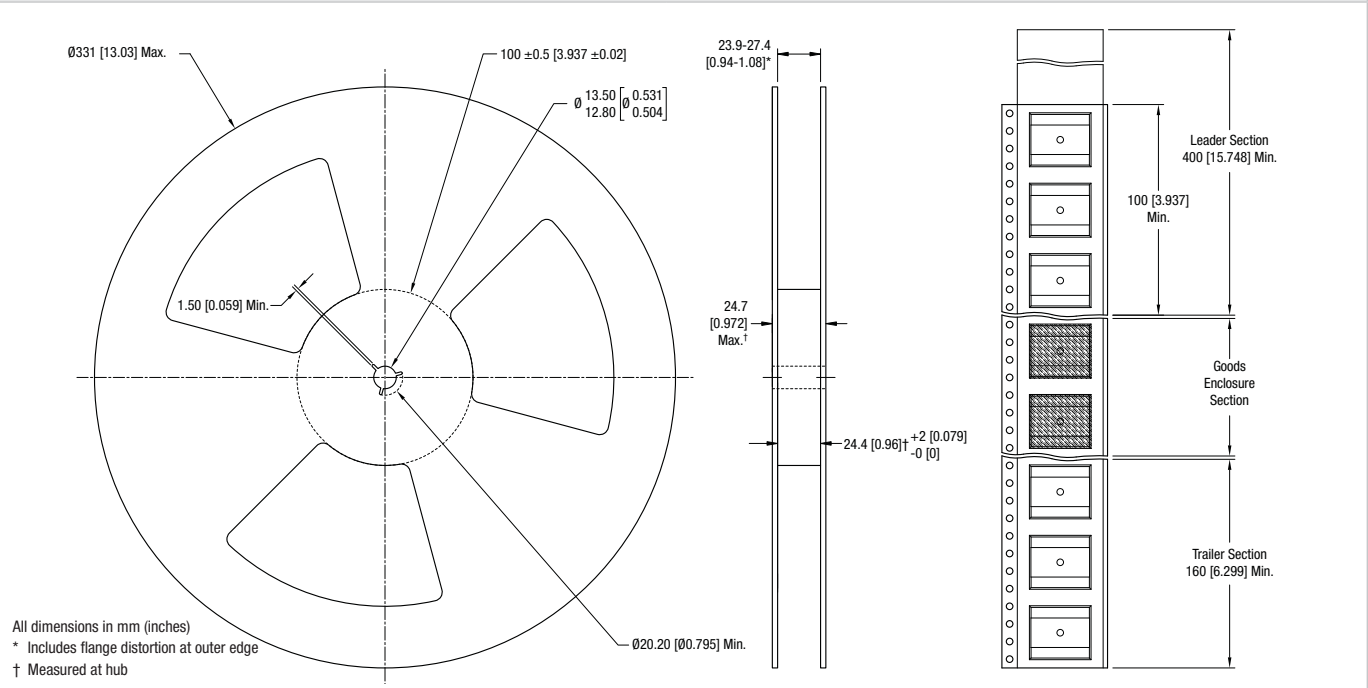

TAPE OUTLINE DIMENSIONS

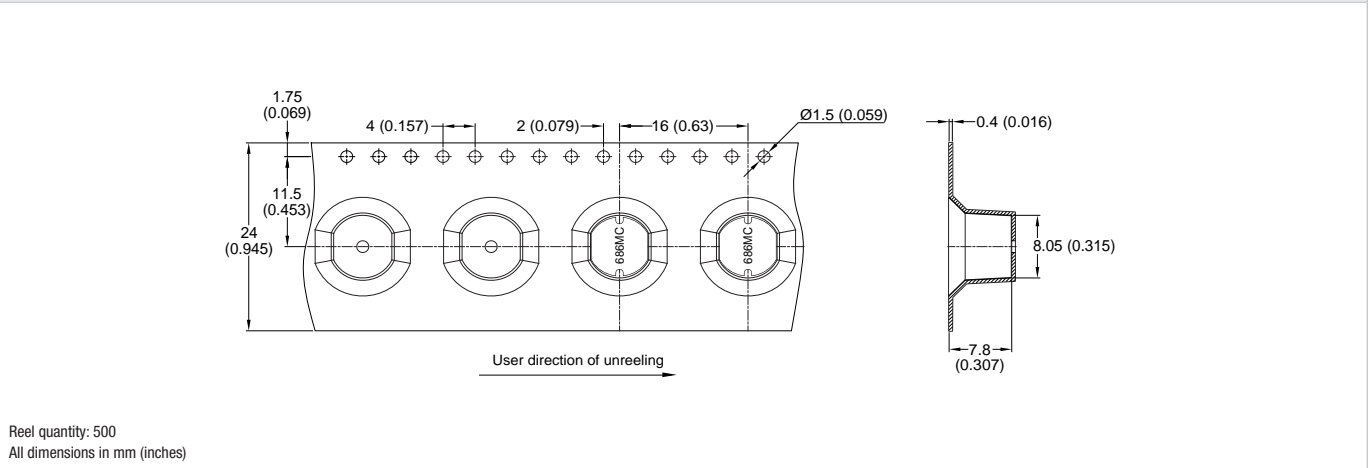

Murata Power Solutions, Inc.
11 Cabot Boulevard, Mansfield, MA 02048-1151 U.S.A.
ISO 9001 and 14001 REGISTERED

Murata Power Solutions, Inc. makes no representation that the use of its products in the circuits described herein, or the use of other technical information contained herein, will not infringe upon existing or future patent rights. The descriptions contained herein do not imply the granting of licenses to make, use, or sell equipment constructed in accordance therewith. Specifications are subject to change without notice.
© 2011 Murata Power Solutions, Inc.