

Small Signal Product

Low VF SMD Schottky Barrier Diode

FEATURES

- Metal-on-silicon schottky barrier
- Surface device type mounting
- Moisture sensitivity level 1
- Matte Tin(Sn) lead finish with Nickel(Ni) underplat
- Packing code with suffix "G" means green compound (halogen-free)

SOT-23
MECHANICAL DATA

- Case: SOT- 23, molded plastic
- Terminal: Matte tin plated, lead free, solderable per MIL-STD-202, Method 208 guaranteed
- High temperature soldering guaranteed: 260°C/10s
- Weight: 0.008g (approximately)

| MAXIMUM RATINGS AND ELECTRICAL CHARACTERISTICS (T _A =25°C unless otherwise noted) | | | |
|--|-----------------------------------|-------------|------|
| PARAMETER | SYMBOL | VALUE | UNIT |
| Power Dissipation | P _D | 200 | mW |
| Repetitive Peak Reverse Voltage | V _{RRM} | 40 | V |
| Reverse Voltage | V _R | 40 | V |
| Repetitive Peak Forward Current | I _{FRM} | 200 | mA |
| Mean Forward Current | I _O | 200 | mA |
| Non-Repetitive Peak Forward Surge Current (Note 1) | I _{FSM} | 0.6 | A |
| Thermal Resistance (Junction to Ambient) (Note 2) | R _{θJA} | 357 | °C/W |
| Junction and Storage Temperature Range | T _J , T _{STG} | -65 to +125 | °C |

| PARAMETER | SYMBOL | MIN | MAX | UNIT |
|---|-------------------|-----|------|------|
| Reverse Breakdown Voltage I _R =10μA | V _(BR) | 40 | - | V |
| Forward Voltage I _F =1mA I _F =10mA I _F =40mA | V _F | - | 0.38 | V |
| | | - | 0.50 | |
| | | - | 1.00 | |
| Reverse Leakage Current V _R =30V | I _R | - | 0.2 | μA |
| Junction Capacitance V _R =1V, f=1.0MHz | C _J | - | 5.0 | pF |
| Reverse Recovery Time I _F =I _R =10mA, R _L =100Ω, I _{RR} =1mA | t _{rr} | - | 5.0 | ns |

Notes : 1. Test Condition : 8.3ms single half sine-wave superimposed on rated load

Notes : 2. Valid provided that electrodes are kept at ambient temperature

Small Signal Product

RATINGS AND CHARACTERISTICS CURVES

(TA=25°C unless otherwise noted)

Fig.1 Power Derating Curve

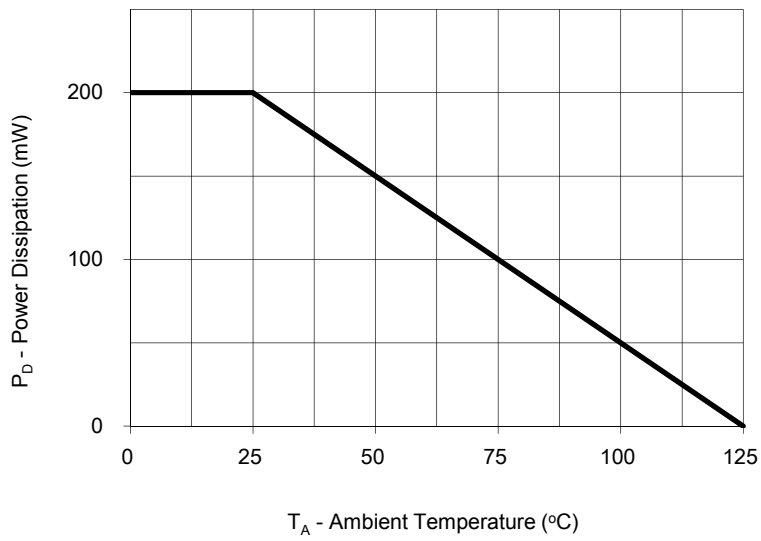

Fig. 2 Maximum Non-Repetitive Peak Forward Surge Current Per Leg

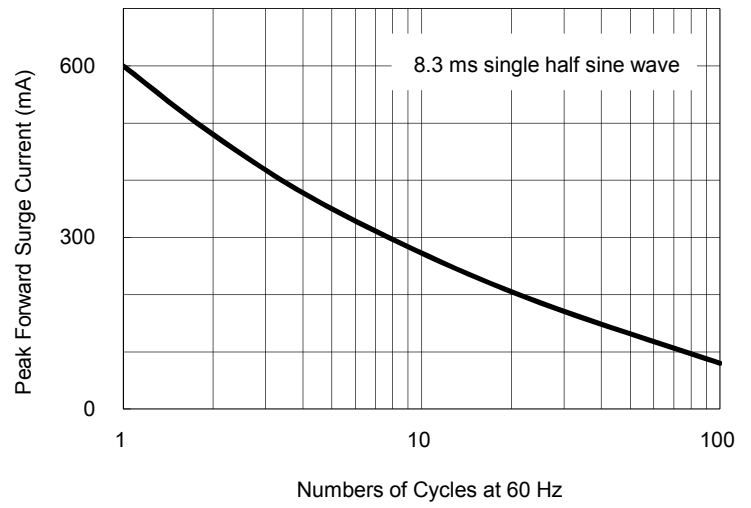

Fig. 3 Typical Forward Characteristics

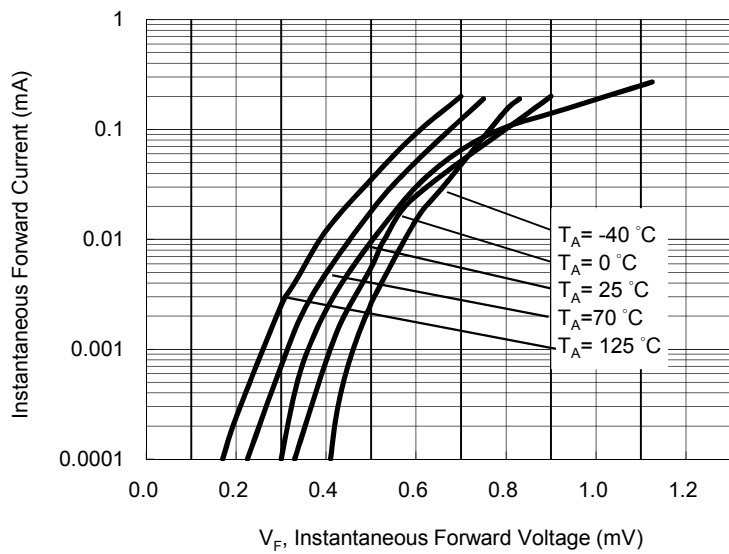

Fig. 4 Typical Reverse Characteristics

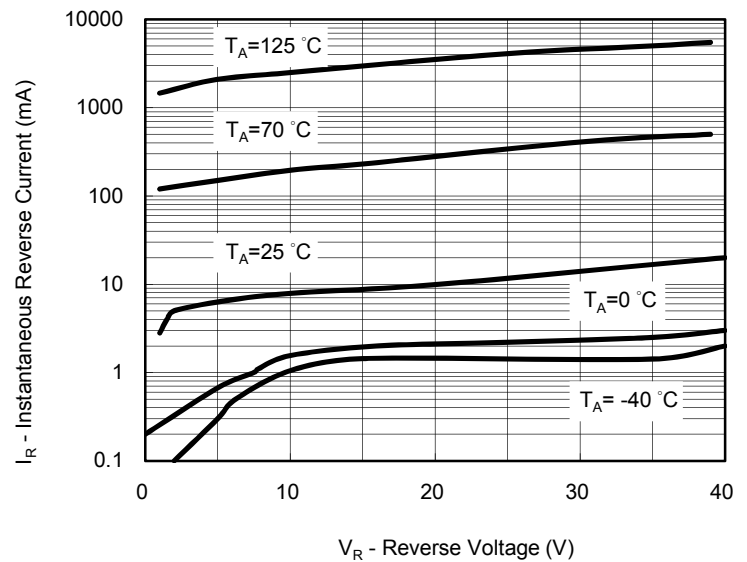

Fig. 5 Typical Total Capacitance VS. Reverse Voltage

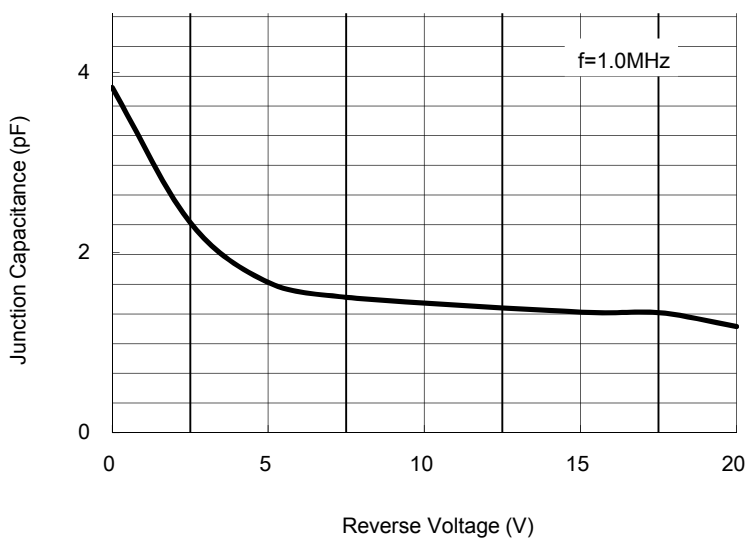
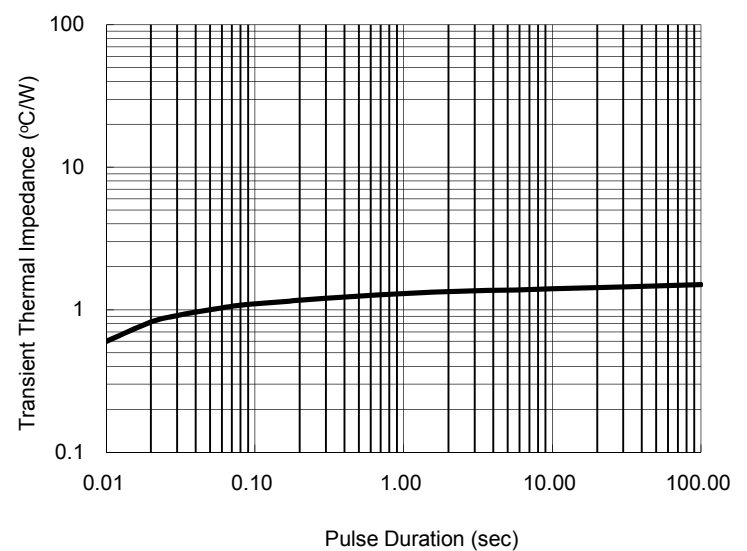

Fig. 6 Typical Transient Thermal



Small Signal Product

| ORDERING INFORMATION | | | | | | |
|----------------------|-----------------------------|-----------------|------------------------|---------|--------------|---------|
| PART NO. | PART NO. SUFFIX (Note 1) | PACKING CODE | PACKING CODE SUFFIX | PACKAGE | PACKING | MARKING |
| BAS40 | -xx | RF | G | SOT-23 | 3K / 7" Reel | 43 |
| BAS40-04 | | | | | | 44 |
| BAS40-05 | | | | | | 45 |
| BAS40-06 | | | | | | 46 |

Note 1: Part No. Suffix „-xx “ would be used for special requirement

| EXAMPLE | | | | | |
|---------------|----------|--------------------|--------------|------------------------|---|
| PREFERRED P/N | PART NO. | PART NO. SUFFIX | PACKING CODE | PACKING CODE SUFFIX | DESCRIPTION |
| BAS40 RF | BAS40 | | RF | | Multiple manufacture source |
| BAS40 RFG | BAS40 | | RF | G | Multiple manufacture source Green compound |
| BAS40-D0 RFG | BAS40 | -D0 | RF | G | Define manufacture source Green compound |

Small Signal Product

PACKAGE OUTLINE DIMENSIONS

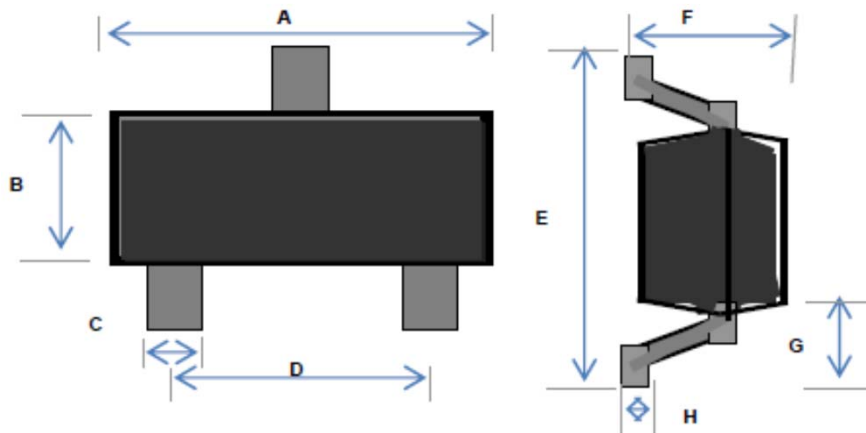

| DIM. | Unit(mm) | | Unit(inch) | |
|------|----------|------|------------|-------|
| | Min | Max | Min | Max |
| A | 2.70 | 3.10 | 0.106 | 0.122 |
| B | 1.10 | 1.50 | 0.043 | 0.059 |
| C | 0.30 | 0.51 | 0.012 | 0.020 |
| D | 1.78 | 2.04 | 0.070 | 0.080 |
| E | 2.10 | 2.64 | 0.083 | 0.104 |
| F | 0.89 | 1.30 | 0.035 | 0.051 |
| G | 0.55 REF | | 0.022 REF | |
| H | 0.10 REF | | 0.004 REF | |

SUGGEST PAD LAYOUT

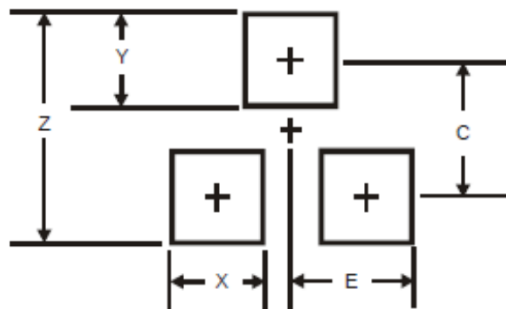

| DIM. | Unit(mm) | Unit(inch) |
|------|----------|------------|
| | Typ. | Typ. |
| Z | 2.8 | 0.11 |
| X | 0.7 | 0.03 |
| Y | 0.9 | 0.04 |
| C | 1.9 | 0.07 |
| E | 1.0 | 0.04 |

PIN CONFIGURATION

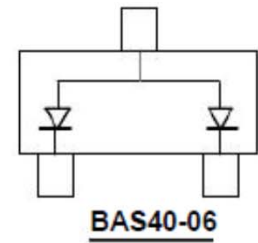
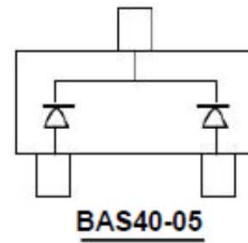
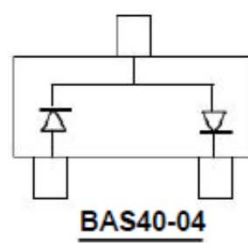
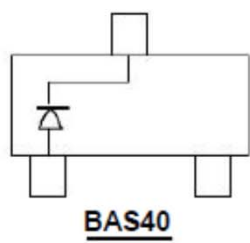

Notice

Specifications of the products displayed herein are subject to change without notice. TSC or anyone on its behalf, assumes no responsibility or liability for any errors or inaccuracies.

Information contained herein is intended to provide a product description only. No license, express or implied, to any intellectual property rights is granted by this document. Except as provided in TSC's terms and conditions of sale for such products, TSC assumes no liability whatsoever, and disclaims any express or implied warranty, relating to sale and/or use of TSC products including liability or warranties relating to fitness for a particular purpose, merchantability, or infringement of any patent, copyright, or other intellectual property right.

The products shown herein are not designed for use in medical, life-saving, or life-sustaining applications. Customers using or selling these products for use in such applications do so at their own risk and agree to fully indemnify TSC for any damages resulting from such improper use or sale.