

Product Specification

GOODARK Type
MBRB10100CT

Construction : Schottky Barrier Rectifier
Application : For General Purpose
(Manufacturer) :
Suzhou Goodark Electronics Co.,Ltd
Prepared on May. 10th, 2011
Prepared: R & D Department
Approva: QRA Department

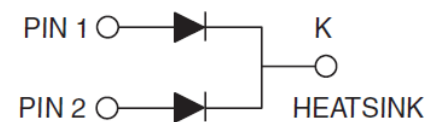
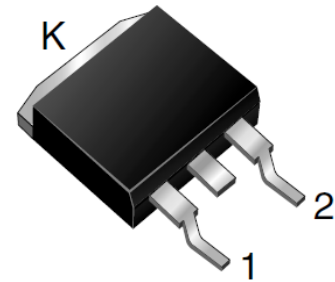

SCHOTTKY BARRIER RECTIFIER
10 AMPERES
100 VOLTS

CONTENTS

1. Package Outline
2. Marking
3. Features& Mechanical Characteristics
4. Maximum Ratings and Electrical Characteristics
5. Rating and characteristic Curves
6. Packing Specification PACKAGING SPECIFICATION
7. Description of Box Label

1. Package Outline (TO263)

UNIT:mm

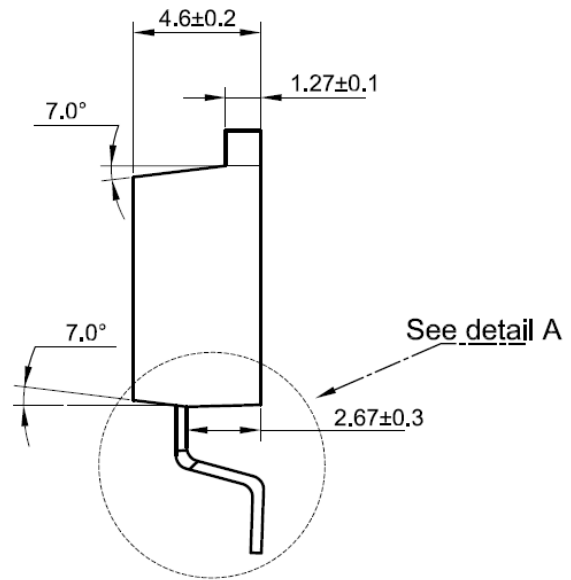
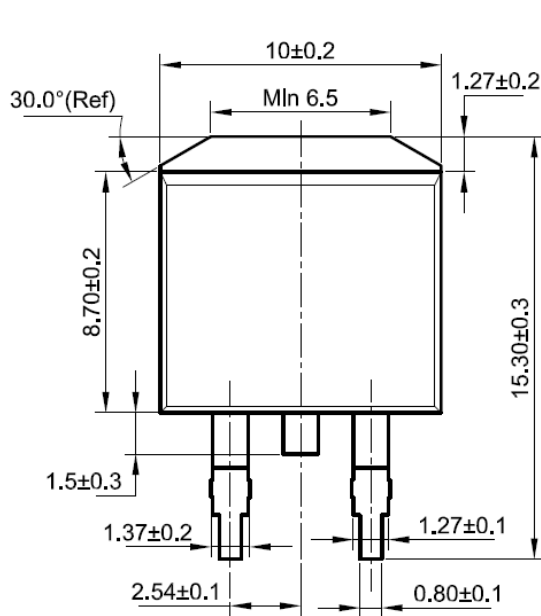

Detail A

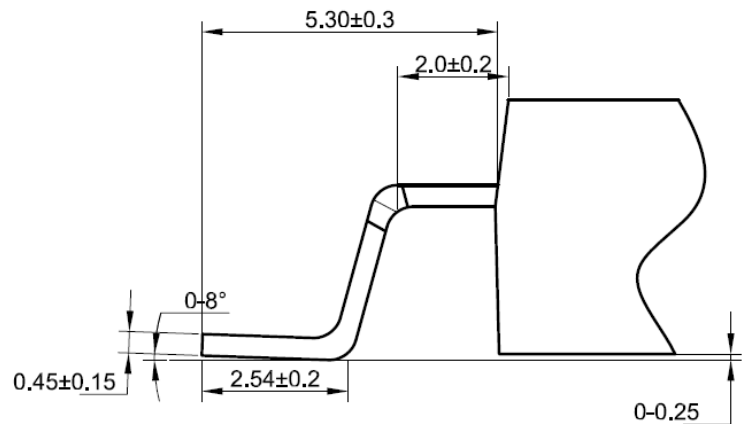

Lead Frame Material : Copper Plating: Pure Tin Plating

2.MARKING

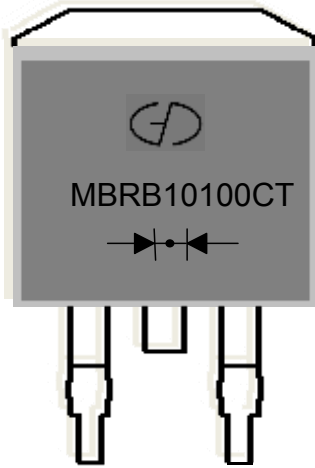

1. Part Name : MBRB10100CT

2. Logo Mark: 

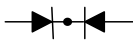
3. Polarity: 



3.Features& Mechanical Characteristics

Features

- Plastic package has underwriters Laboratory Flammability Classification 94V-0
- For surface mounted application
- Metal of silicon rectifier, majority carrier conduction
- Low forward voltage, high efficiency
- Guarding for over voltage protection
- For use in low voltage, high frequency inverters,
- Free wheeling, and polarity protection applications

Mechanical Characteristics

- Case: Epoxy, Molded
- Weight: 1.4grams (approximately)
- Finish: All External Surfaces Corrosion Resistant and Terminal Leads are Readily Solderable
- Lead Temperature for Soldering Purposes: 260°C Max.for10 sec
- Shipped 50 units per plastic tube or tape reel packing 800/reel

4.Maximum Ratings and Electrical Characteristics

MAXIMUM RATINGS and ELECTRICAL CHARACTERISTICS(TC=25°C unless otherwise moted)					
PARAMETER	TEST CONDITIONS		SYMBOL	MBRB10100CT	UNIT
Maximum repetitive peak reverse voltage			VRRM	100	V
Working peak reverse voltage			VRWM	100	V
Maximum DC blocking voltage			VDC	100	V
Maximum average forward rectified current at Tc=105°C total device per diode			IF(AV)	10 5	A
Peak forward surge current 8.3ms single half sine-wave superimposed on rated load per diode			IFSM	125	A
Peak repetitive reverse current per leg at tp=2.0us , 1KHz			IRRM	0.5	A
Voltage rate of change (rated VR)			DV/dt	10000	V/us
Operating junction temperature range			TJ	-55 to +150	°C
Storage temperature range			TSTG	-55 to +150	°C
Maximum instantaneous forward voltage per leg	IF=5A IF=5A	TC=25°C TC=125°C	VF	0.85 0.75	V
Maximum reverse current per leg at working peak Reverse voltage			IR	200 6	uA mA

Thermal Characteristics Ta=25°C unless otherwise noted

Symbol	Parameter	Max	Unit
RejC	Thermal Resistance, Junction to Case per Leg	2.0	°C /W

Note:

1. Pulse test:300us pulse width, duty cycle=2%



5. Rating and Characteristic Curves (Tc=25°C Unless otherwise noted)

Rating and Characteristic Curves

(TA=25°C unless otherwise noted)

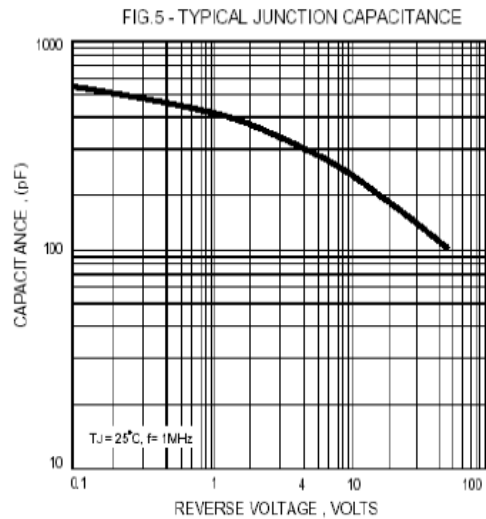
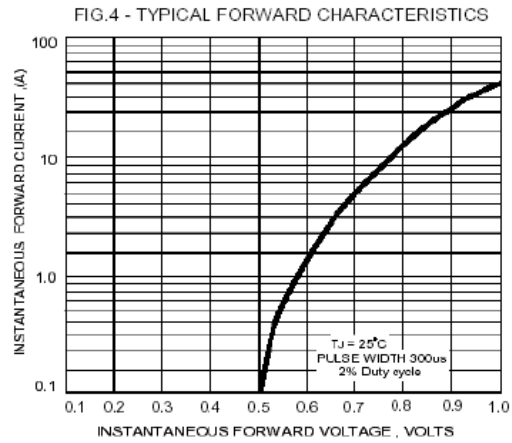
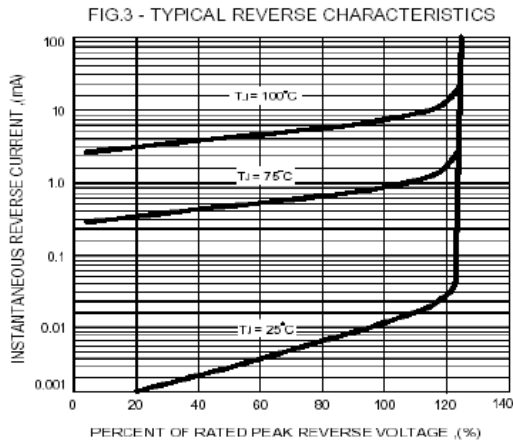
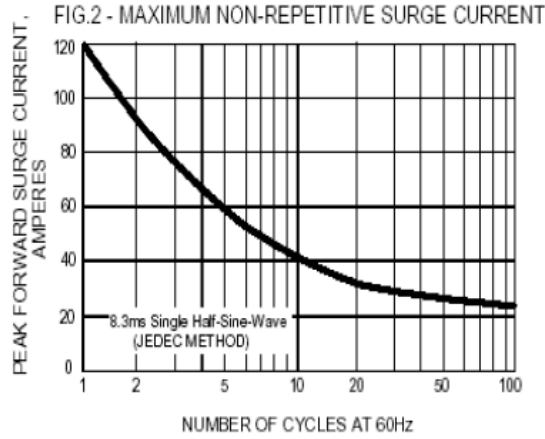
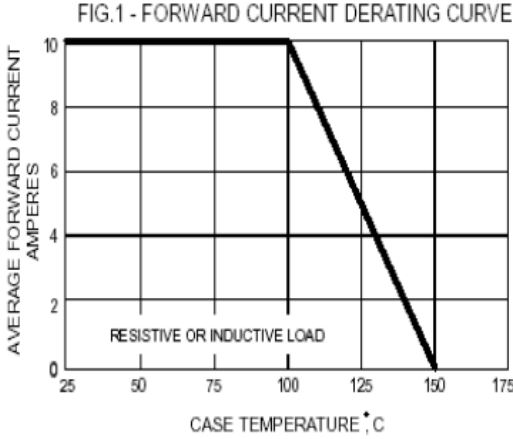

6. Packing Specification

6.1 Tube packing

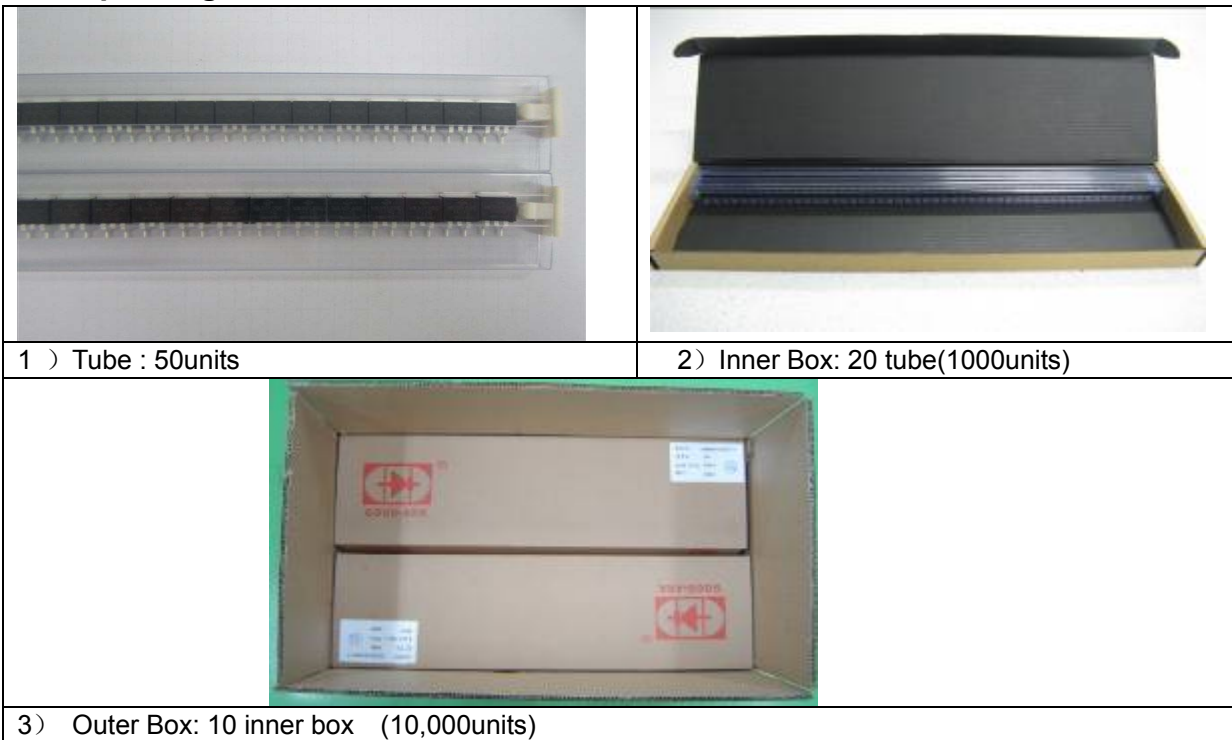

6.2 Tape&reel packing

Packing size:800 /reel(13' reel)

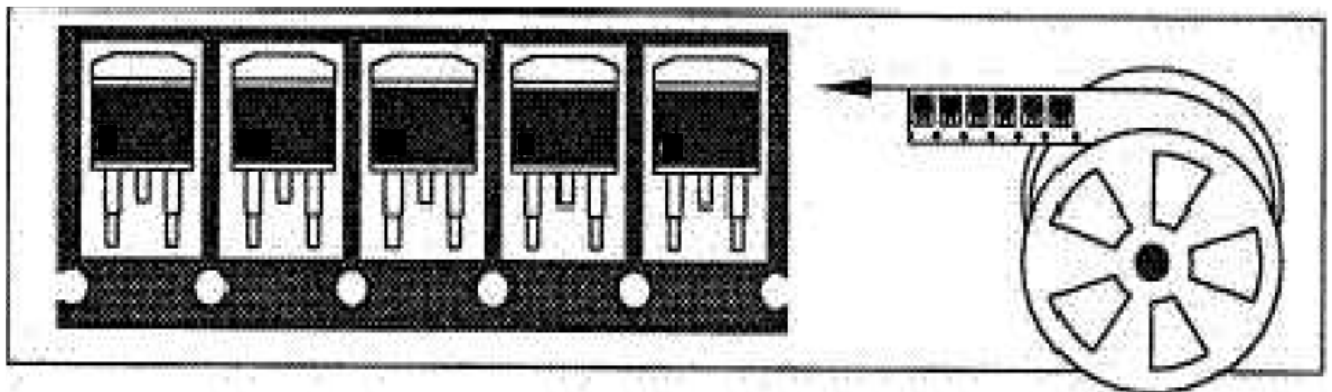

7. DESCRIPTION of BOX LABEL

	<p>TYPE: Q'TY: P/O NO: LOT NO:</p>
<p>1) Inner Box Label</p>	<p>2) Inner Box Label</p>
	<p>TYPE: Q'TY: P/O NO:</p>
<p>3) Outer Box Label</p>	<p>4) Outer Box Label</p>