

AS1522, AS1523

10-Bit, Single-Supply, Low-Power, 400/300ksps, 4-Channel A/D Converters

Product Brief

1 General Description

The AS1522/AS1523 are low-power, 4/2-channel, 400/300ksps, 10-bit analog-to-digital (A/D) converters specifically designed to operate with single-supply devices. Superior AC characteristics, very low power consumption, and highly-reliable packaging make these ultra-small devices perfect for battery-powered remote-sensor and data-acquisition devices.

The successive-approximation register (SAR), high-speed sampling, high-bandwidth track/hold circuitry, and multi-mode operation combine to make these devices highly-flexible and configurable.

Both devices require low supply current (2.8mA @ 400ksps, AS1522; 2.2mA @ 300ksps, AS1523) and feature a reduced-power mode and a power-down mode to lower power consumption at slower throughput rates.

The devices operate from a single supply (+4.5 to +5.5V, AS1522; +2.7 to +3.6V, AS1523). Both devices contain an internal 2.5V reference, an integrated reference buffer, and feature support for an external reference (1V to V_{DD}).

Data accesses are made via the high-speed, 4-wire, SPI, QSPI-, and Microwire-compatible serial interface.

The devices are available in a 16-pin TSSOP package.

2 Key Features

- Single-Supply Operation:
 - +4.5 to +5.5V (AS1522)
 - +2.7 to +3.6V (AS1523)
- Sampling Rate:
 - 400ksps (AS1522)
 - 300ksps (AS1523)
- Software-Configurable Analog Input Types:
 - 4-Channel Single-Ended
 - 4-Channel Pseudo Differential Referenced to COM
 - 2-Channel Pseudo Differential
 - 2-Channel Fully Differential
- Software-Configurable Input Range
- Internal +2.5V Reference
- Low-Current Operation:
 - 2.8mA @ 400ksps (AS1522)
 - 2.2mA @ 300ksps (AS1523)
 - 0.4mA in Reduced-Power Mode
 - 0.5µA in Full Power-Down Mode
- SPI/QSPI/Microwire/TMS320-Compatible
- 16-pin TSSOP Package

3 Applications

The devices are ideal for remote sensors, data-acquisition and data-logging devices, pen-digitizers, process control, or any other space-limited A/D application with low power-consumption requirements.

Figure 1. Block Diagram and Pin Assignments

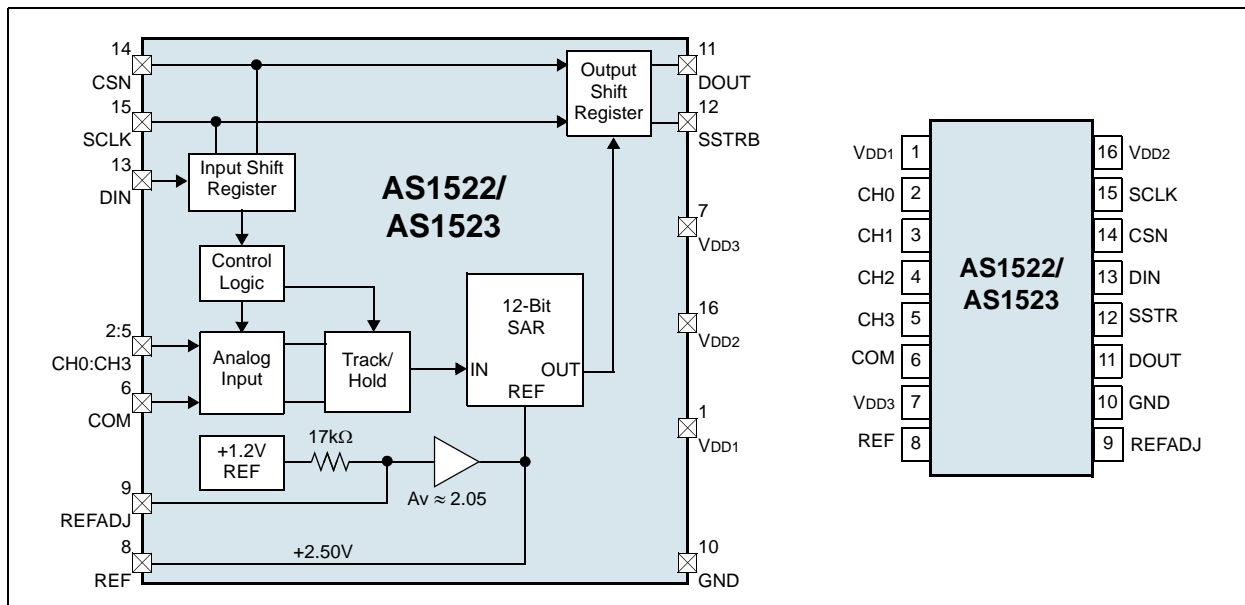

Copyrights

Copyright © 1997-2007, austriamicrosystems AG, Schloss Premstaetten, 8141 Unterpremstaetten, Austria-Europe. Trademarks Registered ®. All rights reserved. The material herein may not be reproduced, adapted, merged, translated, stored, or used without the prior written consent of the copyright owner.

All products and companies mentioned are trademarks or registered trademarks of their respective companies.

Disclaimer

Devices sold by austriamicrosystems AG are covered by the warranty and patent indemnification provisions appearing in its Term of Sale. austriamicrosystems AG makes no warranty, express, statutory, implied, or by description regarding the information set forth herein or regarding the freedom of the described devices from patent infringement. austriamicrosystems AG reserves the right to change specifications and prices at any time and without notice. Therefore, prior to designing this product into a system, it is necessary to check with austriamicrosystems AG for current information. This product is intended for use in normal commercial applications. Applications requiring extended temperature range, unusual environmental requirements, or high reliability applications, such as military, medical life-support or life-sustaining equipment are specifically not recommended without additional processing by austriamicrosystems AG for each application. For shipments of less than 100 parts the manufacturing flow might show deviations from the standard production flow, such as test flow or test location.

The information furnished here by austriamicrosystems AG is believed to be correct and accurate. However, austriamicrosystems AG shall not be liable to recipient or any third party for any damages, including but not limited to personal injury, property damage, loss of profits, loss of use, interruption of business or indirect, special, incidental or consequential damages, of any kind, in connection with or arising out of the furnishing, performance or use of the technical data herein. No obligation or liability to recipient or any third party shall arise or flow out of austriamicrosystems AG rendering of technical or other services.



Contact Information

Headquarters

austriamicrosystems AG
A-8141 Schloss Premstaetten, Austria

Tel: +43 (0) 3136 500 0
Fax: +43 (0) 3136 525 01

For Sales Offices, Distributors and Representatives, please visit:

<http://www.austriamicrosystems.com/contact>