



DMT10-2-2111

DMT

LONG RANGE DISTANCE SENSORS

SICK
Sensor Intelligence.



Ordering information

Type	Part no.
DMT10-2-2111	1028540

Other models and accessories → www.sick.com/DMT



Detailed technical data

Performance

Measuring range	0.5 m ... 155 m, 90 % remission 0.5 m ... 65 m, 18 % remission 0.5 m ... 40 m, 6 % remission
Resolution	≤ 1 mm
Repeatability	7 mm ^{1) 2)} 10 mm ^{3) 2)}
Accuracy	± 10 mm ^{4) 5)}
Response time	1 ms ... 3,000 ms ⁶⁾
Cycle time	1,024 per sec.
Average depth	1/16/64/256/1,024
Output time	1 ms ... 4,000 ms ⁷⁾
Aperture delay time	≥ 1 ms ⁷⁾
Light source	Laser, infrared
Laser class	1 (EN 60825-1:Nov.2001, IEC 60825-1:ÄM2:2001)
Typ. light spot size (distance)	20 mm (+ 5 x distance in m)
Note	Electronic aperture
Special characteristic	Electronic aperture

¹⁾ Dependent on distance and remission, 7 mm, at 6% ... 90% remission from 0.5 m ... 65 m, at 6% ... 18% remission from 0.5 m ... 40 m, at 6% remission from 0.5 m ... 15 m.

²⁾ Environmental conditions constant, min. warm-up time 30 min, average depth 1,024, statistical error 1 σ .

³⁾ Dependent on distance and remission, 10 mm, at 6% ... 90% remission from 60 m ... 155 m, at 6% ... 18% remission from 40 m ... 65 m, at 6% remission from 15 m ... 40 m.

⁴⁾ 23 °C air temperature, 977 hPa, min. warm-up time 30 min.

⁵⁾ When operating in ambient temperatures between +40 °C ... +55 °C the accuracy can decrease by factor 2.5.

⁶⁾ Dependent on averaging method, averaging depth, timeout, baud rate, data output, output format, and delay time.

⁷⁾ Dependent on averaging method, averaging depth, timeout, baud rate, data output, and output format.

Interfaces

Analog output	4 mA ... 20 mA, scalable
Switching output	Q ₁ , Q ₂ ¹⁾

¹⁾ Output Q short-circuit protected.

²⁾ Switchable.

Data interface	RS-422, RS-232 ²⁾
Interface for parametrization	RS-232

¹⁾ Output Q short-circuit protected.

²⁾ Switchable.

Mechanics/electronics

Supply voltage V_s	DC 18 V ... 30 V, limit values
Ripple	$< 5 V_{pp}$ ¹⁾
Power consumption	$\leq 6 W$ ²⁾
Initialization time	6 s
Connection type	1 x terminal connection, 1 x Sub D, 9-pin
Weight	Approx. 1,200 g
Output current I_A	100 mA

¹⁾ May not fall short of or exceed V_s tolerances.

²⁾ Without load.

Ambient data

Enclosure rating	IP 65
Protection class	III ¹⁾
Electromagnetic compatibility (EMC)	EN 55011:1998 Kl. B, Gr.1 EN 61000-6-2
Ambient temperature	Operation: $-10\text{ °C} \dots +55\text{ °C}$ Operation with cooling case: $-10\text{ °C} \dots +75\text{ °C}$ Storage: $-25\text{ °C} \dots +70\text{ °C}$
Temperature drift	Typ. 0.6 mm/K ²⁾ Typ. 0.3 mm/K ³⁾
Mechanical load	Shock: (IEC 60068-2-27, -2-29) Sine: (IEC 60068-2-6)

¹⁾ Reference voltage DC 50 V PELV-voltage (EN 50178)

²⁾ $-10\text{ °C} \dots 0\text{ °C}$, $+40\text{ °C} \dots +55\text{ °C}$.

³⁾ $0\text{ °C} \dots +40\text{ °C}$.

Dimensional drawing (Dimensions in mm (inch))

DMT10-2-x1xx DML40-2-x1xx

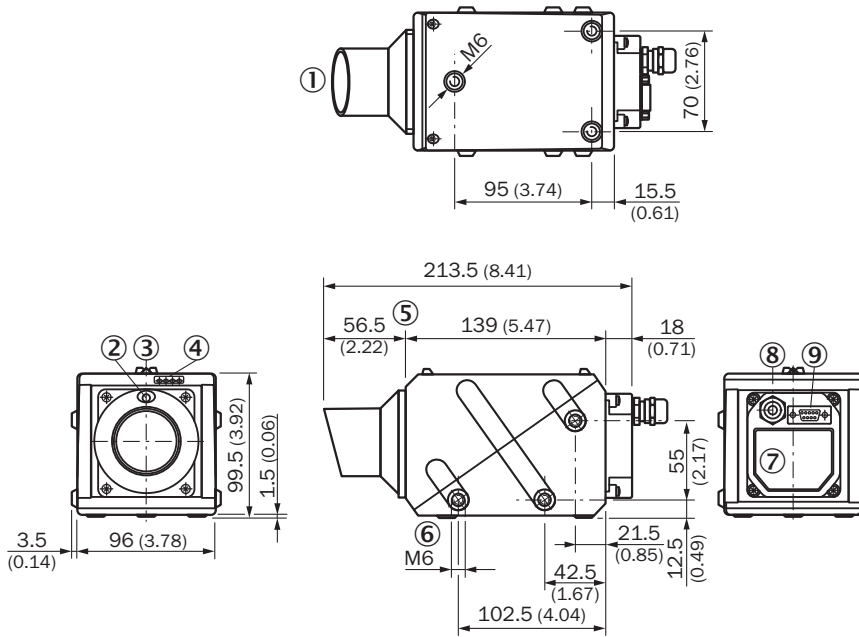

- ① Dust protection tube
- ② Laser pointer pilot light
- ③ Alignment sight
- ④ Function indicator
- ⑤ Zero level
- ⑥ Mounting hole M6 threaded - 6 mm deep
- ⑦ Connector cover
- ⑧ PG9
- ⑨ Sub-D, 9-pin

Connection type

DMxxx-2 RS-232/RS-422 Connector Sub-D, 9-pin

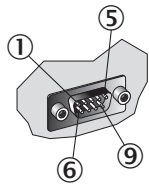

- ① Pin 1
- ⑤ Pin 5
- ⑥ Pin 6
- ⑨ Pin 9

DMxxx-2 RS-232/RS-422 PG9

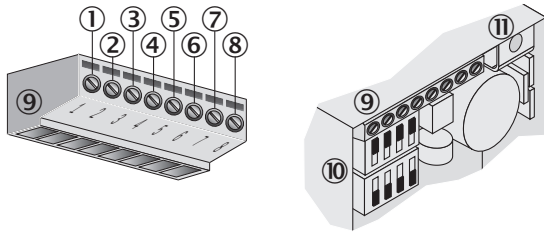

- ① Pin 1
- ② Pin 2
- ③ Pin 3
- ④ Pin 4
- ⑤ Pin 5
- ⑥ Pin 6
- ⑦ Pin 7
- ⑧ Pin 8
- ⑨ Terminals
- ⑩ DIP switches RS-232-/RS-422 switching
- ⑪ Shield

Connection diagram

Connection type RS-232/RS-422

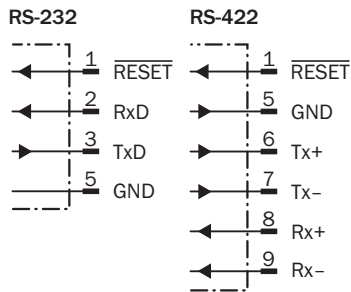

DMxxx-2 RS-232/RS-422 PG9

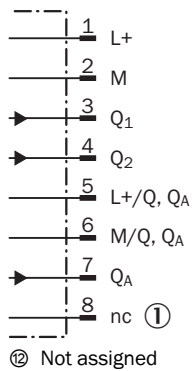

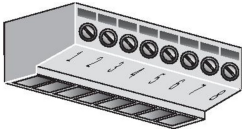

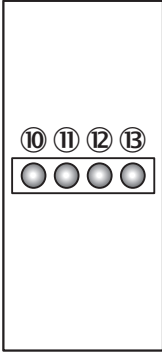

Adjustment possible



- ⑩ Q2 function indicator
- ⑪ Q1 function indicator
- ⑫ Operating indicator, green
- ⑬ Plausibility (measurement error) red

Recommended accessories

Other models and accessories → www.sick.com/DMT

	Brief description	Type	Part no.
Terminal and alignment brackets			
	Alignment unit for DMT/DML, incl. mounting material, steel, zinc coated, mounting hardware included	BEF-GH-DME	5309130
Plug connectors and cables			
	Head A: female connector, D-Sub, 9-pin, straight Head B: cable Cable: serial, unshielded, 3 m	Connecting cable (female connector - open)	2020319

SICK AT A GLANCE

SICK is one of the leading manufacturers of intelligent sensors and sensor solutions for industrial applications. A unique range of products and services creates the perfect basis for controlling processes securely and efficiently, protecting individuals from accidents and preventing damage to the environment.

We have extensive experience in a wide range of industries and understand their processes and requirements. With intelligent sensors, we can deliver exactly what our customers need. In application centers in Europe, Asia and North America, system solutions are tested and optimized in accordance with customer specifications. All this makes us a reliable supplier and development partner.

Comprehensive services complete our offering: SICK LifeTime Services provide support throughout the machine life cycle and ensure safety and productivity.

For us, that is “Sensor Intelligence.”

WORLDWIDE PRESENCE:

Contacts and other locations –www.sick.com