

PROTECTION PRODUCTS - μClamp®

Description

μClamp® TVS diodes are designed to protect sensitive electronics from damage or latch-up due to EOS, lightning, CDE, and ESD. They feature large cross-sectional area junctions for conducting high transient currents. These devices offer desirable characteristics for board level protection including fast response time, low operating and clamping voltage, and no device degradation.

μClamp®3381P features extremely good protection characteristics highlighted by high surge current capability (25A, $t_p=8/20\mu s$), low peak ESD clamping voltage, and high ESD withstand voltage ($\pm 30kV$ contact per IEC 61000-4-2). Typical dynamic resistance is among the industry's best at 0.025 Ohms. Each device will protect one data or power line operating at 3.3 Volts.

μClamp3381P is in a 2-pin SGP1006N2 package measuring 1.0 x 0.6 x 0.5mm. Leads are spaced at a pitch of 0.65mm and feature a lead-free finish. The combination of small size, low operating voltage, and high ESD surge capability makes them ideal for protection of voltage bus lines in optical modules, LCD televisions, and tablet computers.

Features

- ◆ Transient protection for VBus and data lines to IEC 61000-4-2 (ESD) $\pm 30kV$ (air), $\pm 30kV$ (contact)
- IEC 61000-4-4 (EFT) 40A (5/50ns)
- IEC 61000-4-5 (Lightning) 25A (8/20 μs)
- ◆ Protects one line
- ◆ Low ESD clamping voltage
- ◆ Working voltage: 3.3V
- ◆ Low leakage current
- ◆ Extremely low dynamic resistance: 0.025 Ohms (Typ)
- ◆ Solid-state silicon-avalanche technology

Mechanical Characteristics

- ◆ SGP1006N2 package
- ◆ Pb-Free, Halogen Free, RoHS/WEEE Compliant
- ◆ Nominal Dimensions: 1.0 x 0.6 x 0.50 mm
- ◆ Lead Finish: NiPdAu
- ◆ Marking: Marking code
- ◆ Packaging: Tape and Reel

Applications

- ◆ Optical Modules
- ◆ 3.3V VBus Protection
- ◆ LCD TV
- ◆ Tablet PC
- ◆ Instrumentation
- ◆ CCTV Cameras

Package Dimensions

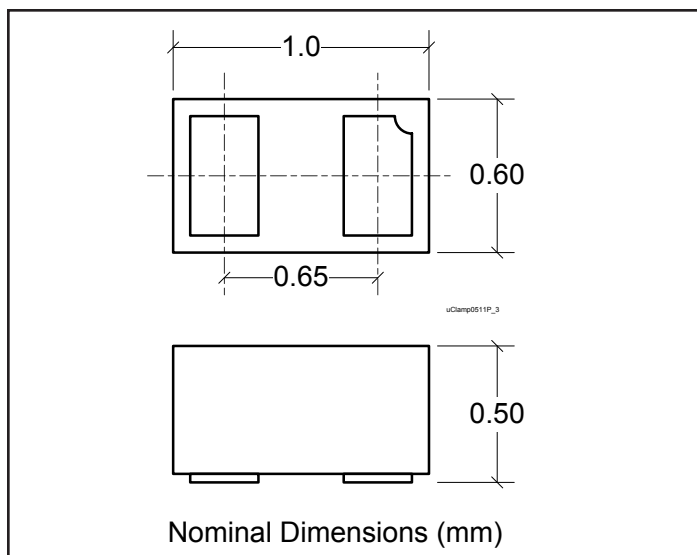

Schematic & Pin Configuration

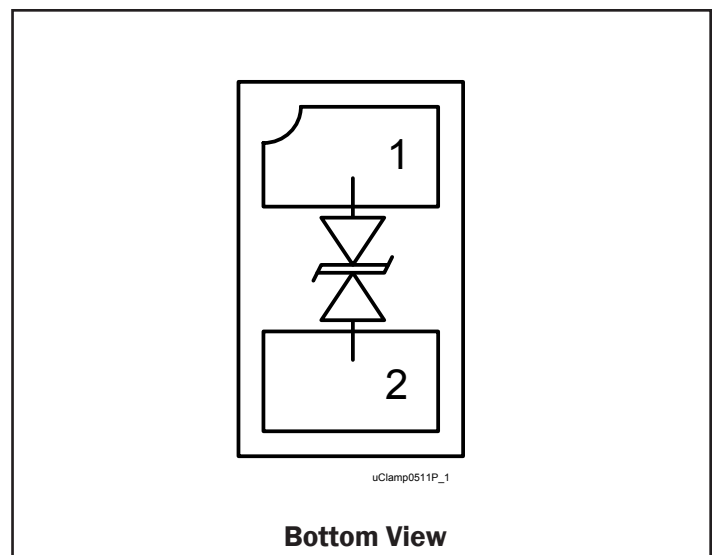

PROTECTION PRODUCTS
Absolute Maximum Ratings

Rating	Symbol	Value	Units
Peak Pulse Power (tp = 8/20μs)	P_{PK}	275	W
Peak Pulse Current (tp = 8/20μs)	I_{PP}	25	A
ESD per IEC 61000-4-2 (Air) ⁽¹⁾ ESD per IEC 61000-4-2 (Contact) ⁽¹⁾	V_{ESD}	±30 ±30	kV
Operating Temperature	T_J	-40 to +125	°C
Storage Temperature	T_{STG}	-55 to +150	°C

Electrical Characteristics (T=25°C unless otherwise specified)

Parameter	Symbol	Conditions	Min.	Typ.	Max.	Units
Reverse Stand-Off Voltage	V_{RWM}	Pin 1 to 2 or Pin 2 to 1			3.3	V
Reverse breakdown Voltage	V_{BR}	$I_{BR} = 1mA$ Pin 1 to 2 or Pin 2 to 1	4.5	8.5	10	V
Reverse Leakage Current	I_R	$V_{RWM} = 3.3V$ Pin 1 to 2 or Pin 2 to 1		1	100	nA
Clamping Voltage	V_C	$I_{PP} = 25A$, tp = 8/20μs			11.5	V
ESD Clamping Voltage ²	V_C	$I_{PP} = 4A$ tp = 0.2/100ns		8.3		V
ESD Clamping Voltage ²	V_C	$I_{PP} = 16A$ tp = 0.2/100ns		8		V
Dynamic Resistance ^{2,3}	R_{DYN}	tp = 100ns		0.025		Ohms
Junction Capacitance	C_J	I/O pin to GND f = 1MHz		$V_R = 0V$ 30	35	pF

Notes

- 1) Measured with a 20dB attenuator, 50 Ohm scope input impedance, 2GHz bandwidth. ESD gun return path connected to ESD ground plane.
- 2) Transmission Line Pulse Test (TLP) Settings: tp = 100ns, tr = 0.2ns, I_{TLP} and V_{TLP} averaging window: t1 = 70ns to t2 = 90ns.
- 3) Dynamic resistance calculated from $I_{TLP} = 4A$ to $I_{TLP} = 16A$

PROTECTION PRODUCTS

Typical Characteristics

Non-Repetitive Peak Pulse Power vs. Pulse Time

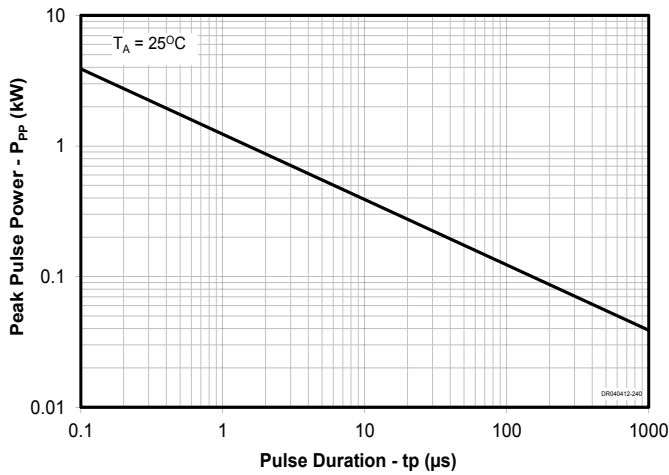

Clamping Voltage vs. Peak Pulse Current (tp=8/20us)

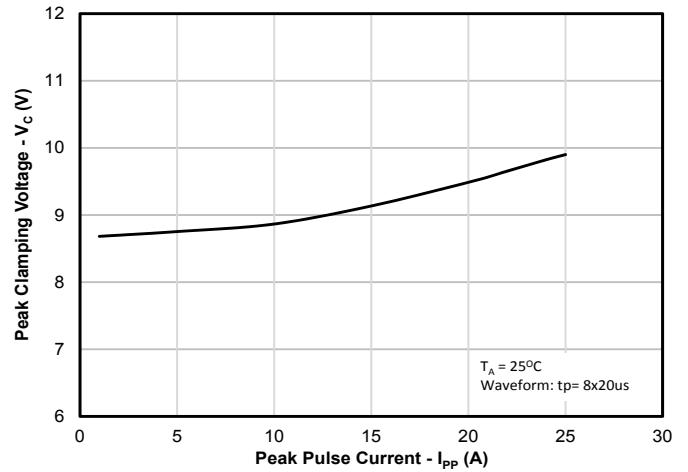

TLP Characteristic

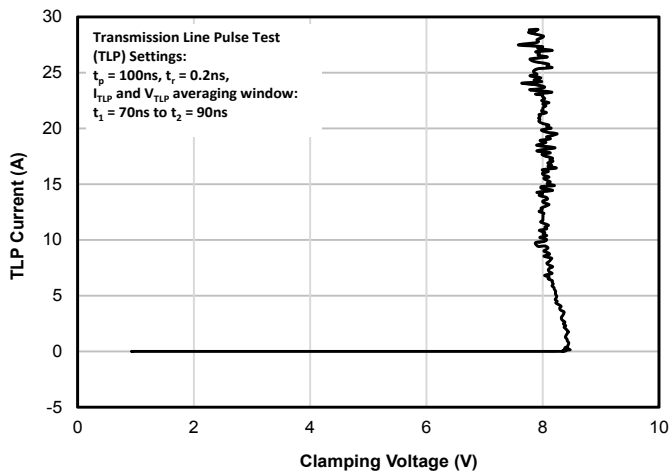

Typical Breakdown Voltage vs. Temperature

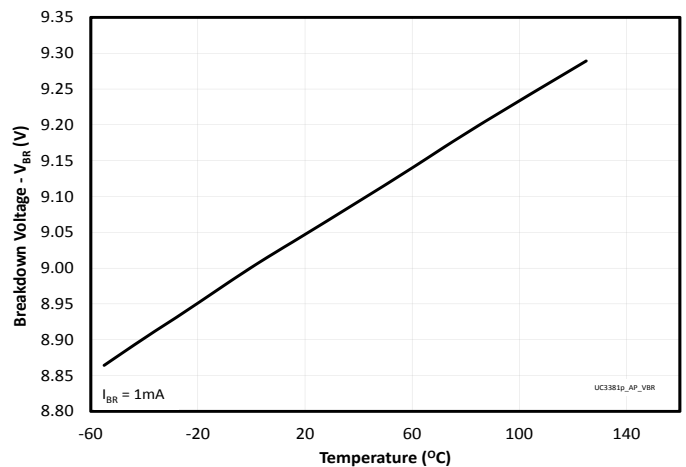

ESD Clamping (8kV Contact per IEC 61000-4-2)

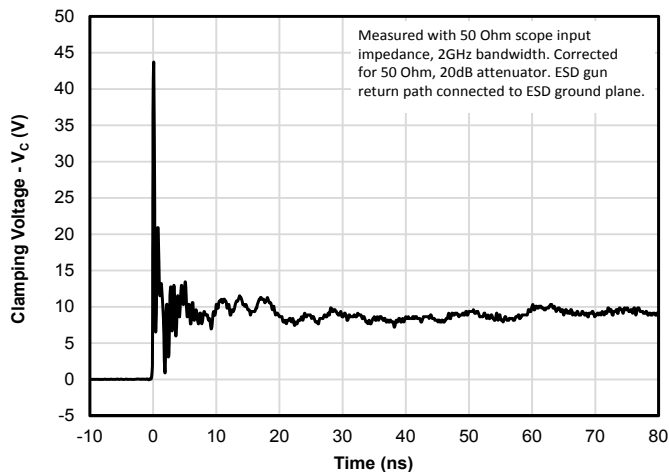

ESD Clamping (-8kV Contact per IEC 61000-4-2)

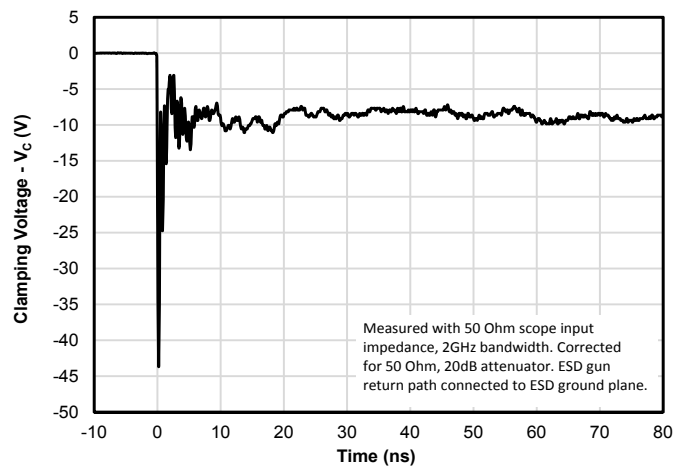

PROTECTION PRODUCTS

Outline Drawing - SGP1006N2

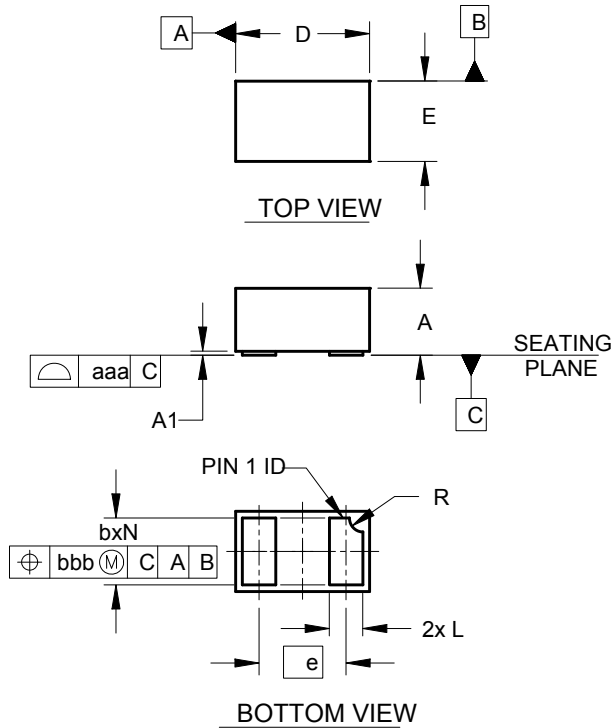

DIM	INCHES			MILLIMETERS		
	MIN	NOM	MAX	MIN	NOM	MAX
A	.016	.020	.022	0.40	0.50	0.55
A1	.000	.001	.002	0.00	0.03	0.05
b	.018	.020	.022	0.45	0.50	0.55
D	.035	.039	.043	0.90	1.00	1.10
E	.020	.024	.028	0.50	0.60	0.70
e	.026 BSC			0.65 BSC		
L	.008	.010	.012	0.20	0.25	0.30
R	.002	.004	.006	0.05	0.10	0.15
N	2			2		
aaa	.003			0.08		
bbb	.004			0.10		

SLP1006P2-1-R0

NOTES:

1. CONTROLLING DIMENSIONS ARE IN MILLIMETERS (ANGLES IN DEGREES).

Land Pattern - SGP1006N2

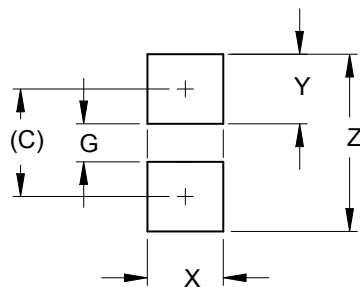

DIM	DIMENSIONS	
	INCHES	MILLIMETERS
C	(.033)	(0.85)
G	.012	0.30
X	.024	0.60
Y	.022	0.55
Z	.055	1.40

SLP1006P2-2-R0

NOTES:

1. CONTROLLING DIMENSIONS ARE IN MILLIMETERS (ANGLES IN DEGREES).
2. THIS LAND PATTERN IS FOR REFERENCE PURPOSES ONLY. CONSULT YOUR MANUFACTURING GROUP TO ENSURE YOUR COMPANY'S MANUFACTURING GUIDELINES ARE MET.

PROTECTION PRODUCTS

Marking

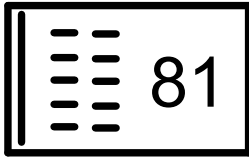

Notes: Device is Electrically Symmetrical

Ordering Information

Part Number	Qty per Reel	Reel Size
μClamp3381P.TFT	15000	7"

Notes:

1) MicroClamp, uClamp and μClamp are trademarks of Semtech Corporation.

Tape and Reel Specification

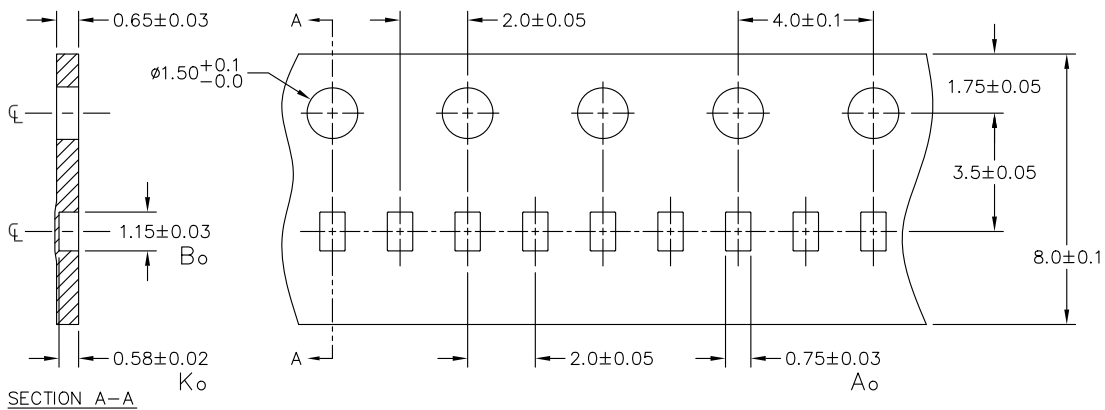

NOTES: ALL DIMENSIONS IN MILLIMETERS UNLESS OTHERWISE SPECIFIED.

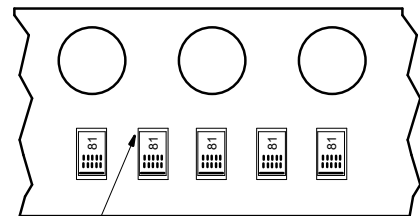

Marking Code Location
(Towards Sprocket Holes)

Contact Information

Semtech Corporation
 Protection Products Division
 200 Flynn Rd., Camarillo, CA 93012
 Phone: (805)498-2111 FAX (805)498-3804