

## Transient Voltage Suppressors for ESD Protection

### General Description

The LESD5D5.0CT1G is designed to protect voltage sensitive components from ESD and transient voltage events. Excellent clamping capability, low leakage, and fast response time, make these parts ideal for ESD protection on designs where board space is at a premium.

### Applications

- Cellular phones
- Portable devices
- Digital cameras
- Power supplies

### Features

- Small Body Outline Dimensions
- Low Body Height
- Peak Power up to 150 Watts @ 8 x 20  $\mu$ s Pulse
- Low Leakage current
- Response Time is Typically < 1 ns
- ESD Rating of Class 3 (> 16 kV) per Human Body Model
- IEC61000-4-2 Level 4 ESD Protection
- IEC61000-4-4 Level 4 EFT Protection

### LESD5D5.0CT1G

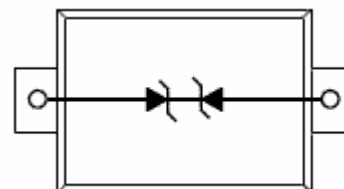
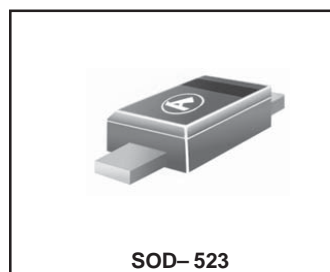

### ORDERING INFORMATION

Device	Marking	Shipping
LESD5D5.0CT1G	C	3000/Tape & Reel

### Absolute Ratings ( $T_{amb}=25^{\circ}C$ )

Symbol	Parameter	Value	Units	
$P_{PP}$	Peak Pulse Power ( $t_p = 8/20 \mu s$ )	150	W	
$T_L$	Maximum lead temperature for soldering during 10s	260	$^{\circ}C$	
$T_{stg}$	Storage Temperature Range	-55 to +155	$^{\circ}C$	
$T_{op}$	Operating Temperature Range	-40 to +125	$^{\circ}C$	
$T_j$	Maximum junction temperature	150	$^{\circ}C$	
	IEC61000-4-2 (ESD)	air discharge contact discharge	$\pm 15$ $\pm 8$	KV
	IEC61000-4-4 (EFT)		40	A
	ESD Voltage	Per Human Body Model	16	KV

# LESD5D5.0CT1G

## Electrical Parameter

Symbol	Parameter
$I_{PP}$	Maximum Reverse Peak Pulse Current
$V_C$	Clamping Voltage @ $I_{PP}$
$V_{RWM}$	Working Peak Reverse Voltage
$I_R$	Maximum Reverse Leakage Current @ $V_{RWM}$
$I_T$	Test Current
$V_{BR}$	Breakdown Voltage @ $I_T$

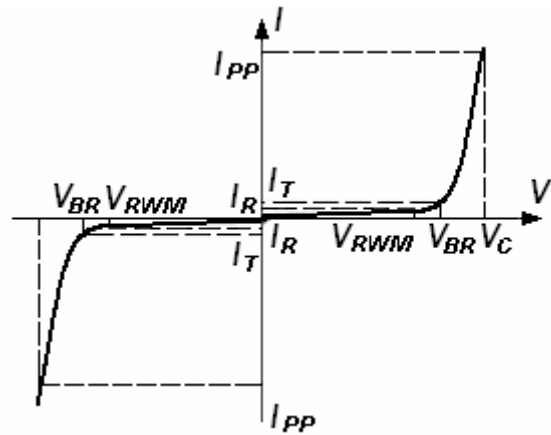

## Electrical Characteristics

Ratings at 25°C ambient temperature unless otherwise specified. VF = 0.9V at IF = 10mA

Device	$V_{RWM}$ (V)	$I_R$ (uA) @ $V_{RWM}$	$V_{BR}$ (V) @ $I_T$ (Note 1)		$I_T$	$V_C$ (V) @ $I_{PP}=5 A^*$	$V_C$ (V) @ Max $I_{PP}^*$	$I_{PP}$ (A)*	$P_{PK}$ (W)*	C (pF)
	Max	Max	Min	Max	mA	Typ	Max	Max	Max	Typ
LESD5D5.0CT1G	5.0	1	5.6	7.8	1.0	11.6	18.6	9.4	174	15

\*Surge current waveform per Figure 1.

- $V_{BR}$  is measured with a pulse test current  $I_T$  at an ambient temperature of 25°C.

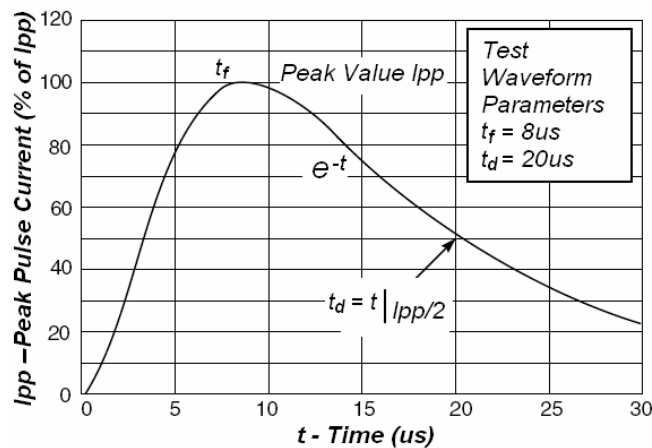
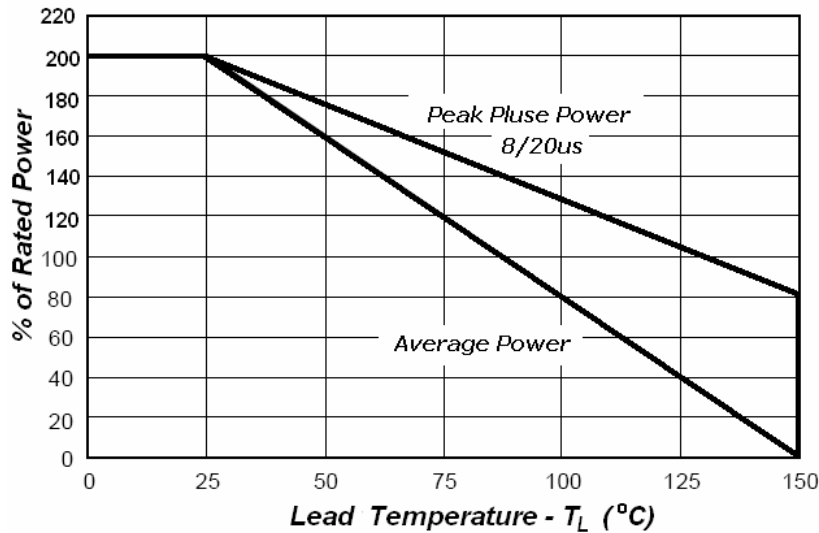

Fig1. Pulse Waveform

**LESD5D5.0CT1G****Fig2.Power Derating****Application Note**

Electrostatic discharge (ESD) is a major cause of failure in electronic systems. Transient Voltage Suppressors (TVS) are an ideal choice for ESD protection. They are capable of clamping the incoming transient to a low enough level such that damage to the protected semiconductor is prevented.

Surface mount TVS offers the best choice for minimal lead inductance. They serve as parallel protection elements, connected between the signal lines to ground. As the transient rises above the operating voltage of the device, the TVS becomes a low impedance path diverting the transient current to ground. The LESD5D5.0CT1G is the ideal board level protection of ESD sensitive semiconductor components.

The tiny SOD-523 package allows design flexibility in the design of high density boards where the space saving is at a premium. This enables to shorten the routing and contributes to hardening against ESD.

# LESD5D5.0CT1G

## SC-79/SOD-523

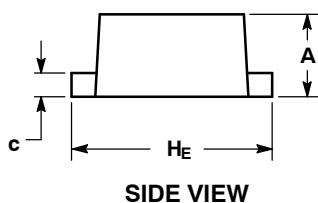
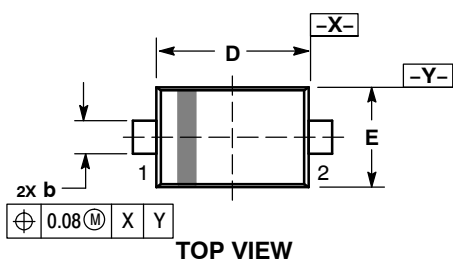

### RECOMMENDED SOLDERING FOOTPRINT\*

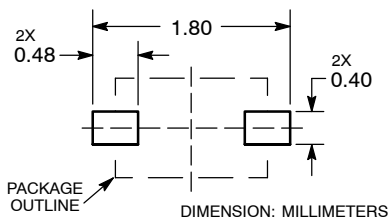

**NOTES:**

1. DIMENSIONING AND TOLERANCING PER ASME Y14.5M, 1994.
2. CONTROLLING DIMENSION: MILLIMETERS.
3. MAXIMUM LEAD THICKNESS INCLUDES LEAD FINISH. MINIMUM LEAD THICKNESS IS THE MINIMUM THICKNESS OF BASE MATERIAL.
4. DIMENSIONS D AND E DO NOT INCLUDE MOLD FLASH, PROTRUSIONS, OR GATE BURRS.

DIM	MILLIMETERS		
	MIN	NOM	MAX
A	0.50	0.60	0.70
b	0.25	0.30	0.35
c	0.07	0.14	0.20
D	1.10	1.20	1.30
E	0.70	0.80	0.90
H E	1.50	1.60	1.70
L	0.30 REF		
L2	0.15	0.20	0.25

## EMBOSSED TAPE AND REEL DATA FOR DISCRETES CARRIER TAPE SPECIFICATIONS

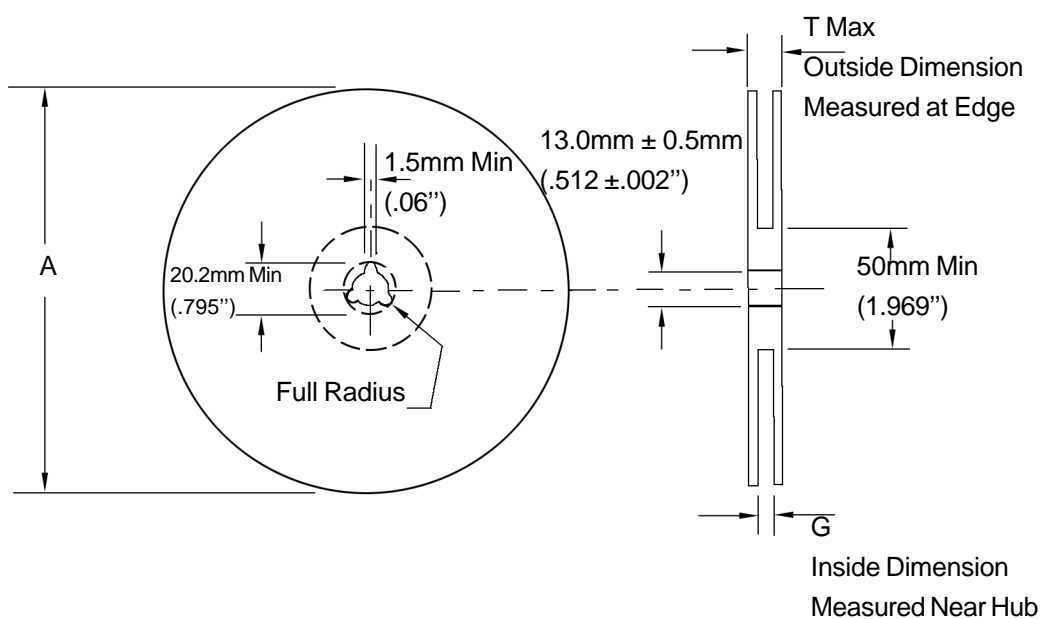

Size	A Max	G	T Max
8 mm	178.0mm (7.0")	8.4mm+1.5mm, -0.0 (.33"+.039", -0.00)	10.9mm (.43")

### Reel Dimensions

Metric Dimensions Govern — English are in parentheses for reference only

### Storage Conditions

Temperature: 5 to 40 Deg.C (20 to 30 Deg. C is preferred)

Humidity: 30 to 80 RH (40 to 60 is preferred )

Recommended Period: One year after manufacturing

(This recommended period is for the soldering condition only. The characteristics and reliabilities of the products are not restricted to this limitation)

## Shipment Specification

