



B3B-440-JB

DESCRIPTION

- Super bright LED Lamp
- Round type
- T-1 3mm diameter
- Lens color: Water Clear
- With Flange
- Solder leads without stand-off
- Compliant with RoHS

FEATURES

- Emitted color: White
- High Luminous intensity
- Technology: InGaN
- Typical emission color: x=0.31, y=0.32
- Viewing angle: 20°

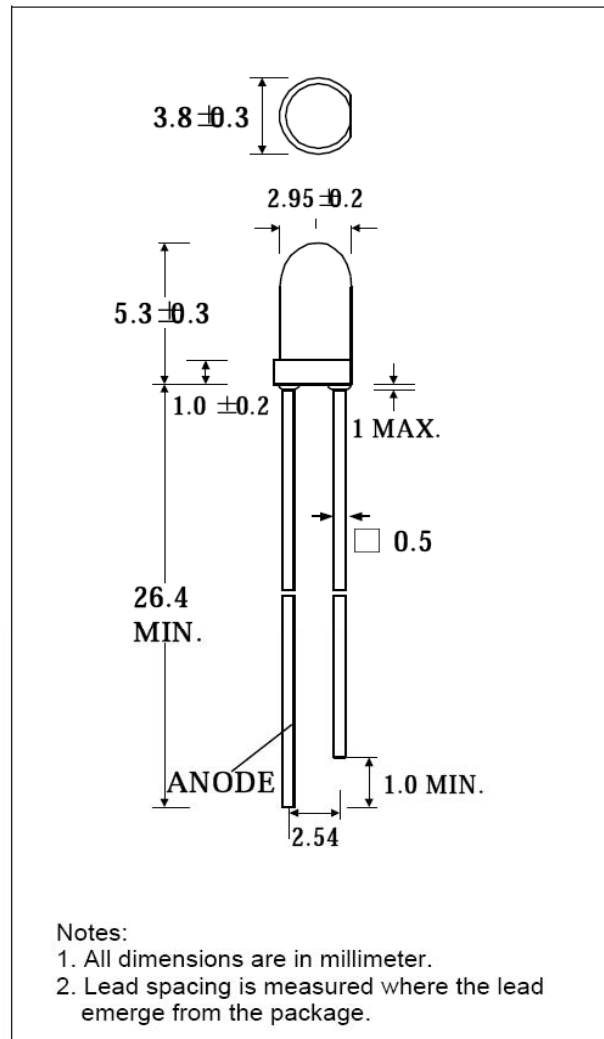

SELECTION GUIDE

Chip Material	Emitted Color	Lens Color	Viewing Angle
InGaN	White	Water Clear	20°



ABSOLUTE MAXIMUM RATINGS

(Ta=25°C)

PARAMETER	SYMBOL	MAX. RATING	Unit
Power Dissipation	P _D	120	mW
Peak Forward Current (1/10 Duty Cycle @1KHz)	I _{FP}	100	mA
Continuous Forward Current	I _F	30	mA
Reverse Voltage	V _R	5.0	V
Operating Temperature Range	T _{OPR}	-40~+85	°C
Storage Temperature Range	T _{STG}	-40~+100	°C

Solder temperature 1.6 mm from body for 3 seconds at 260°C

OPTICAL-ELECTRICAL CHARACTERISTICS

PARAMETER	SYMBOL	TEST CONDITION	MIN	TYP	MAX	UNIT
Luminous Intensity	I _v	I _F = 20mA	2400	3500		mcd
Forward Voltage	V _F	I _F = 20mA		3.5	4.0	V
Reverse Current	I _R	V _R = 5V			10	uA
Viewing Angle	2θ _{1/2}	I _F = 20mA		20		deg.

*Tolerance of Viewing Angle: -10 / +5 deg.



TYPICAL OPTICAL-ELECTRICAL CHARACTERISTIC CURVES

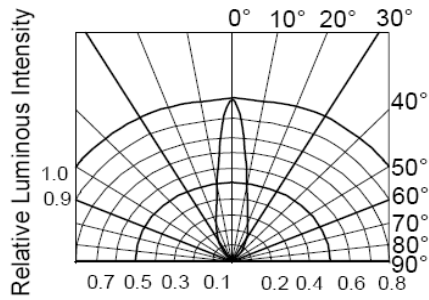

RADIATION DIAGRAM

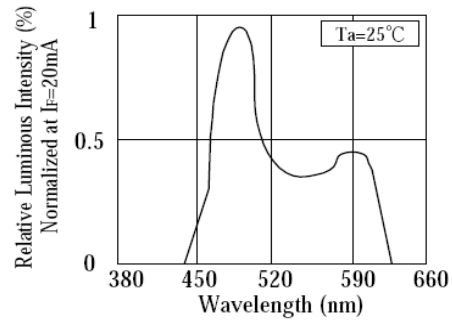

RELATIVE LUMINOUS INTENSITY Vs. WAVELENGTH

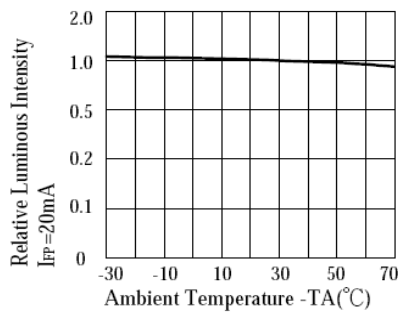

LUMINOUS INTENSITY Vs. AMBIENT TEMPERATURE

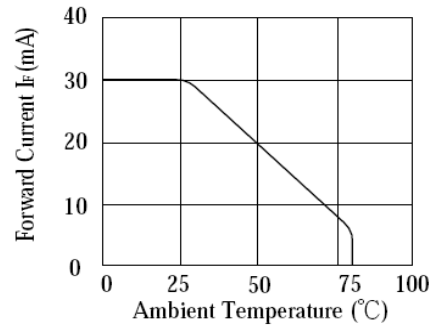

MAX FORWARD CURRENT Vs. AMBIENT TEMPERATURE

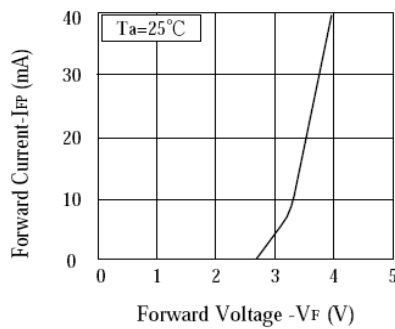

FORWARD CURRENT Vs. FORWARD VOLTAGE

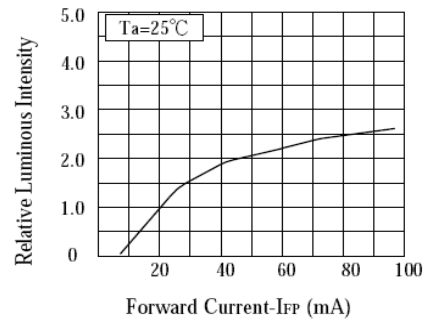

LUMINOUS INTENSITY Vs. FORWARD CURRENT