

### Main Product Characteristics

$V_{DSS}$	55V
$R_{DS(on)}$	4.5mohm(Typ)
$I_D$	110A

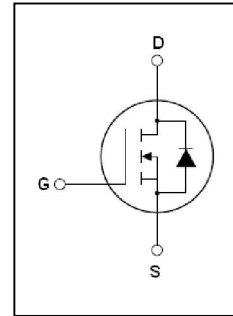
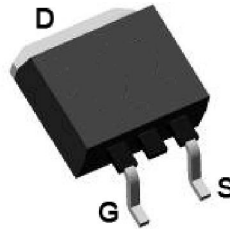

### Features and Benefits

SSF5508A Top View (TO-263)

- Advanced trench MOSFET process technology
- Special designed for convertors and power controls
- Ultra low on-resistance
- 175°C operating temperature
- High Avalanche capability and 100% tested
- Lead free product

### Description

It utilizes the latest trench processing techniques to achieve the high cell density and reduces the on-resistance with high repetitive avalanche rating. These features combine to make this design an extremely efficient and reliable device for use in power switching application and a wide variety of other applications

### Absolute Max Rating:

Symbol	Parameter	Max.	Units
$I_D$ @ TC = 25°C	Continuous Drain Current, VGS @ 10V <sup>①</sup>	110	A
$I_D$ @ TC = 100°C	Continuous Drain Current, VGS @ 10V <sup>①</sup>	80	
IDM	Pulsed Drain Current <sup>②</sup>	440	
ISM	Pulsed Source Current.(Body Diode)	440	
PD @TC = 25°C	Power Dissipation <sup>③</sup>	205	W
	Linear derating factor	2	W/C°
VDS	Drain-Source Voltage	55	V
VGS	Gate-to-Source Voltage	± 20	V
dv/dt	Peak diode recovery voltage	35	v/ns
EAS	Single Pulse Avalanche Energy @ L=0.3mH <sup>②</sup>	634	mJ
IAR	Avalanche Current @ L=0.3mH <sup>②</sup>	65	A
TJ TSTG	Operating Junction and Storage Temperature Range	-55 to + 175	°C

### Thermal Resistance

Symbol	Characterizes	Value	Unit
$R_{\theta JC}$	Junction-to-case <sup>③</sup>	0.73	°C/W
$R_{\theta JA}$	Junction-to-ambient (t ≤ 10s) <sup>④</sup>	50	°C/W

### Electrical Characteristics @ $T_A=25^{\circ}\text{C}$ unless otherwise specified

Symbol	Parameter	Min.	Typ.	Max.	Units	Conditions
BVDSS	Drain-to-Source breakdown voltage	55	60	—	V	$V_{GS} = 0V$ , $I_D = 250\mu A$
RDS(on)	Static Drain-to-Source on-resistance	—	4.5	6	m $\Omega$	$V_{GS} = 10V$ , $I_D = 20A$
VGS(th)	Gate threshold voltage	2	3.1	4	V	$V_{DS} = V_{GS}$ , $I_D = 250\mu A$
IDSS	Drain-to-Source leakage current	—	—	1	$\mu A$	$V_{DS} = 55V$ , $V_{GS} = 0V$
		—	—	10		$V_{DS} = 55V$ , $V_{GS} = 0V$ , $T_J = 150^{\circ}\text{C}$
IGSS	Gate-to-Source forward leakage	—	—	100	nA	$V_{GS} = 20V$
	Gate-to-Source reverse leakage	-100	—	—		$V_{GS} = -20V$
Qg	Total gate charge	—	125	147	nC	$I_D=30A$ $V_{DD}=30V$ $V_{GS}=10V$
Qgs	Gate-to-Source charge	—	24	30		
Qgd	Gate-to-Drain("Miller") charge	—	49	61		
Qg(th)	Gate charge at shreshold	—	16	20		
Vplateau	gate plateau voltage	—	4.7	6	V	
td(on)	Turn-on delay time	—	20	—	ns	$V_{DD}=30V$ $I_D=2A$ , $R_L=15\Omega$ $R_G=2.5\Omega$ $V_{GS}=10V$
tr	Rise time	—	19	—		
td(off)	Turn-Off delay time	—	70	—		
tf	Fall time	—	30	—		
Ciss	Input capacitance	—	5607	—	pF	$V_{GS} = 0V$ , $V_{DS} = 25V$ , $f = 1.0\text{MHz}$
Coss	Output capacitance	—	463	—		
Crss	Reverse transfer capacitance	—	454	—		

### Source-Drain Ratings and Characteristics

Symbol	Parameter	Min.	Typ.	Max.	Units	Conditions
IS	Maximum Body-Diode Continuous Curren	—	110	—	A	
VSD	Diode Forward Voltage	—	0.77	1	V	$I_S=40A$ , $V_{GS}=0V$
Trr	Reverse Recovery Time	—	36	—	ns	$T_J = 25^{\circ}\text{C}$ , $I_F = 68A$ , , $di/dt = 100A/\mu s$
Qrr	Reverse Recovery Charge	—	57	—	nC	
ton	Forward Turn-on Time	Intrinsic turn-on time is negligible (turn-on is dominated by LS+LD)				

### Typical Electrical and Thermal Characteristics

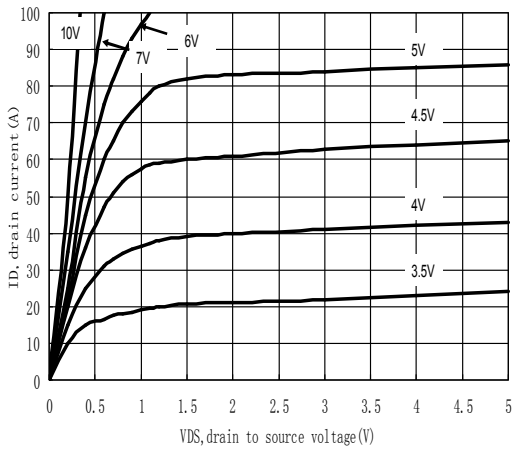

Figure 1: Typical Output Characteristics

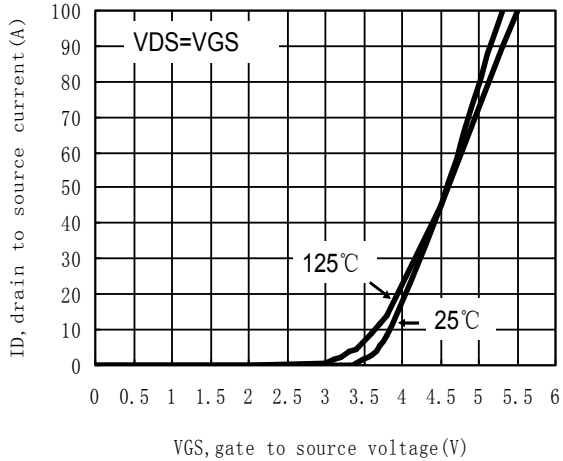

Figure 2: Typical Transfer Characteristics

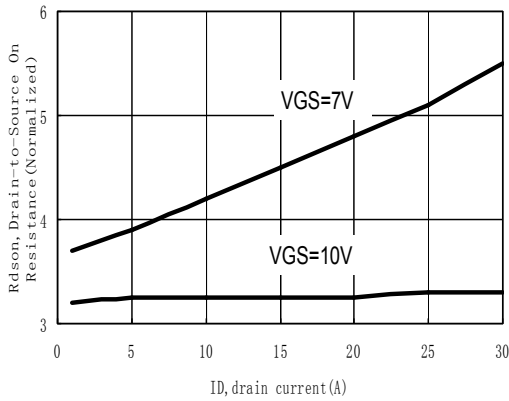

Figure 3: On-Resistance vs. Drain Current and Gate Voltage

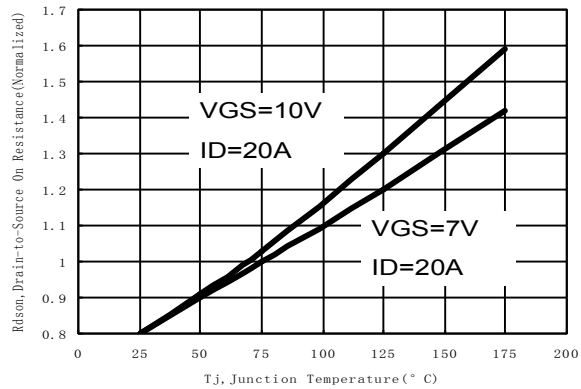

Figure 4: On-Resistance vs. Junction Temperature

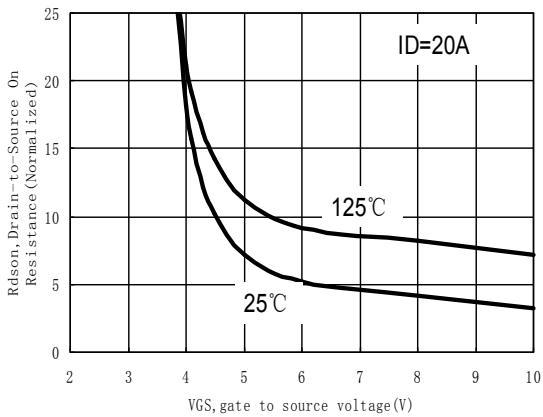

Figure 5: On-Resistance vs. Gate-Source Voltage

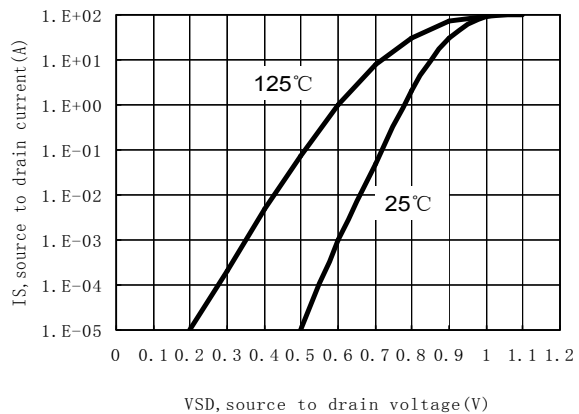

Figure 6: Body-Diode Characteristics

### Typical Electrical and Thermal Characteristics

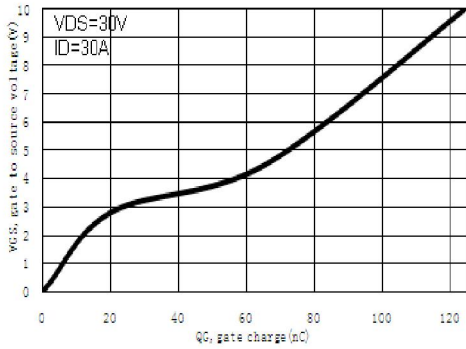

Figure 7: Gate-Charge Characteristics Figure

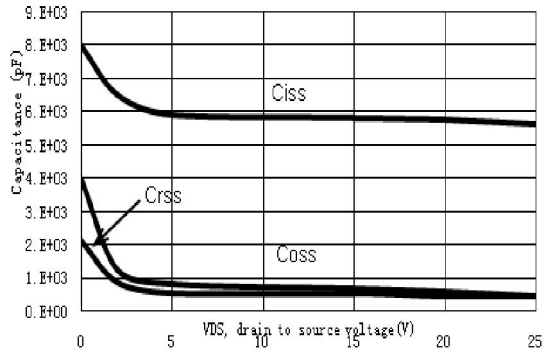

Figure 8: Capacitance Characteristics

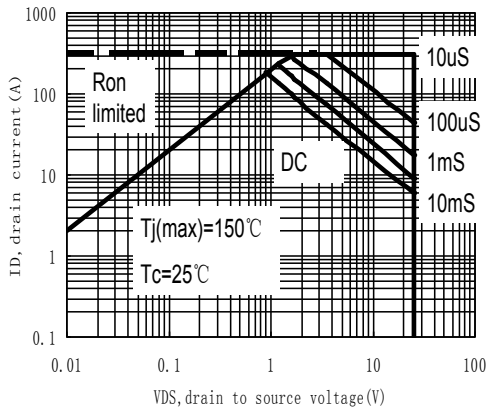

Figure 9: Maximum Forward Biased Safe Operating Area (SOA)

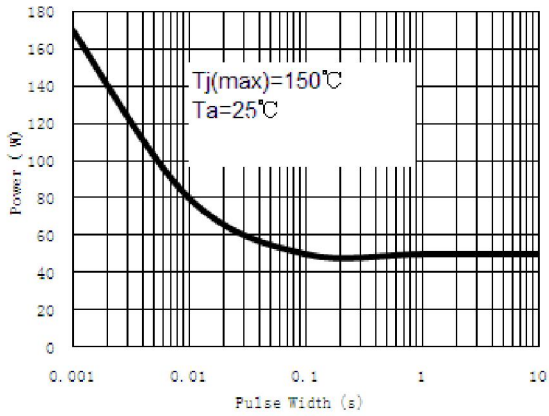

Figure 10: Single Pulse Power Rating Junction-to-Case (JC)

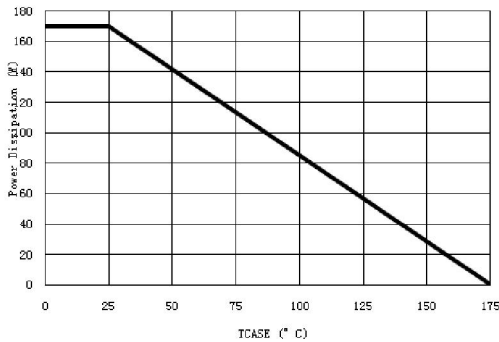

Figure 11: Power De-rating (JC)

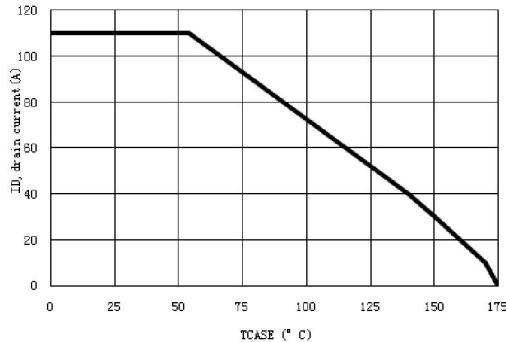

Figure 12: Current De-rating (JC)

### Typical Electrical and Thermal Characteristics

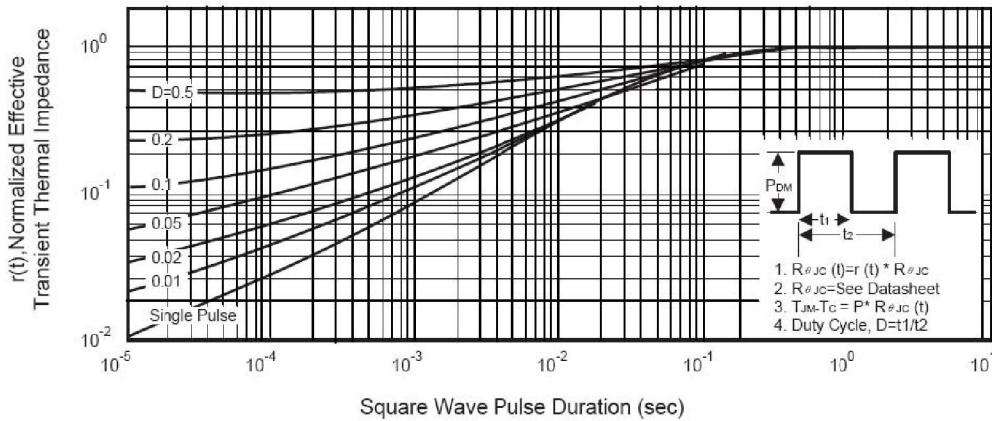
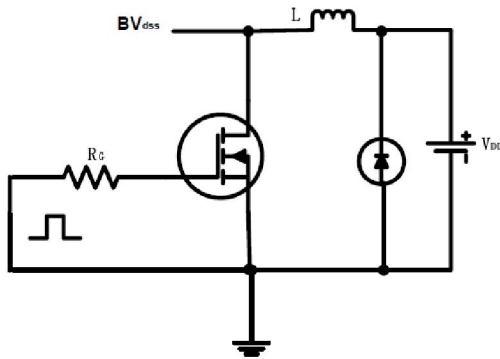
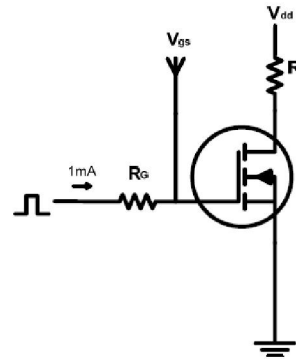

Figure 13: Transient Thermal Impedance Curve

EAS test circuits:



Gate charge test circuit:



Switch Time Test Circuit:

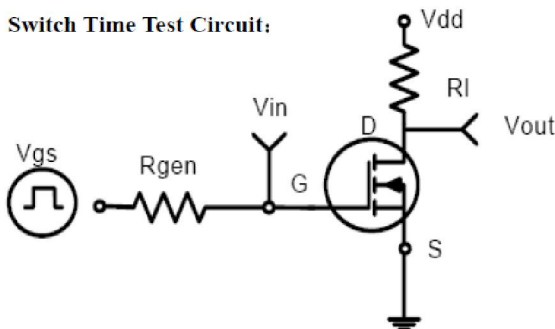

Switch Waveforms

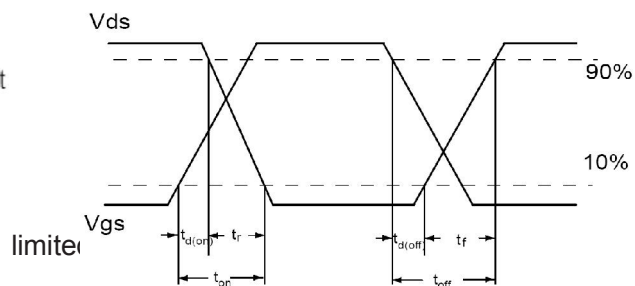

- ② Repetitive rating; pulse width limited by max. junction temperature. EAS starting,  $I_D=65A$ .
- ③ The power dissipation PD is based on max. junction temperature, using junction-to-case thermal resistance.
- ④ The value of  $R_{\theta JA}$  is measured with the device mounted on 1in 2 FR-4 board with 2oz. Copper, in a still air environment with  $T_A = 25^\circ C$ .

### TO-263 MECHANICAL DATA

DIM.	mm.			inch		
	MIN.	TYP	MAX.	MIN.	TYP.	MAX.
A	4.4		4.6	0.173		0.181
A1	2.49		2.69	0.098		0.106
A2	0.03		0.23	0.001		0.009
B	0.7		0.93	0.027		0.036
B2	1.14		1.7	0.044		0.067
C	0.45		0.6	0.017		0.023
C2	1.23		1.36	0.048		0.053
D	8.95		9.35	0.352		0.368
D1		8			0.315	
E	10		10.4	0.393		
E1		8.5			0.334	
G	4.88		5.28	0.192		0.208
L	15		15.85	0.590		0.625
L2	1.27		1.4	0.050		0.055
L3	1.4		1.75	0.055		0.068
M	2.4		3.2	0.094		0.126
R		0.4			0.015	
V2	0°		4°			

