

800mA Low Dropout Fast Response Positive Adjustable Regulator and Fixed  
1.8V, 2.5V and 3.3V

## Features

- Guaranteed Output Voltage Accuracy within 2%
- Fast Transient Response
- Guaranteed Dropout Voltage at Multiple Currents
- Load Regulation : 0.6% Typ.
- Line Regulation : 0.03% Typ.
- Low Dropout Voltage : 1.3V Typ. at  $I_{OUT}=500mA$
- Current Limit : 0.8A Min. at  $T_j=125^{\circ}C$
- On-Chip Thermal Limiting : 150  $^{\circ}C$  Typ.
- Adjustable Output : 1.25~7.15V
- Standard 3-pin SOT-89, SOT-223, TO-92 and TO-252 Power Packages.

## General Description

The APL1087E is a low dropout three-terminal adjustable regulators with 0.8A output current capability. In order to obtain lower dropout voltage and faster transient response, which is critical for low voltage applications, the APL1087E has been optimized. The device is available in an adjustable version and fixed output voltages of 1.8V, 2.5V and 3.3V, the output available voltage range is from 1.25~7.15V with an input supply below 9V. Dropout voltage is guaranteed at a maximum of 1.45V at 0.5A. Current limit is trimmed to ensure specified output current and controlled short-circuit current. On-chip thermal limiting provides protection against any combination of overload that would create excessive junction temperatures. The APL1087E is available in the industry standard 3-pin SOT-89, SOT-223, TO-92 and TO-252 power packages.

## Applications

- Voltage Regulator for CD-ROM Drivers
- Voltage Regulator for LAN Cards
- Voltage Regulator for mother Boards
- Wireless Communication Systems
- Portable Instrument
- Portable Consumer Equipment
- Low Voltage Systems

## Pin Description

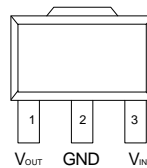

SOT-89 (Front View)

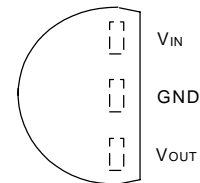

TO-92 (Top View)

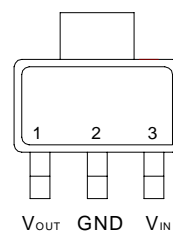



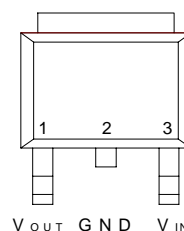





SOT-223 (Front View)

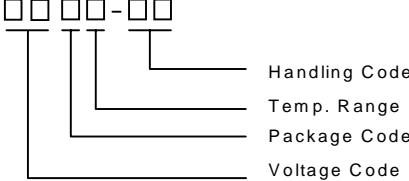

TO-252 (Front View)

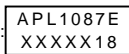
ANPEC reserves the right to make changes to improve reliability or manufacturability without notice, and advise customers to obtain the latest version of relevant information to verify before placing orders.

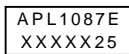
## Ordering and Marking Information

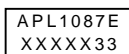
<p>APL1087E- □□□□-□□</p>  <p>Handling Code Temp. Range Package Code Voltage Code</p>	<p>Package Code D : SOT-89      E : TO-92 U : TO-252      V : SOT-223</p> <p>Temp. Range C : 0 to 70 °C</p> <p>Handling Code TU : Tube      TR : Tape &amp; Reel</p> <p>Voltage Code 18 : 1.8V      25 : 2.5V      33 : 3.3V Blank : Adjustable Version</p>
<p>APL1087E U:  XXXXX - Date Code</p>	<p>APL1087E D/V/E :  XXXXX - Date Code</p>
<p>APL1087E-18U:  XXXXX - Date Code</p>	<p>APL1087E-18D/V/E :  XXXXX - Date Code</p>
<p>APL1087E-25U:  XXXXX - Date Code</p>	<p>APL1087E-25D/V/E :  XXXXX - Date Code</p>
<p>APL1087E-33U:  XXXXX - Date Code</p>	<p>APL1087E-33D/V/E :  XXXXX - Date Code</p>

## Absolute Maximum Ratings

Symbol	Parameter	Rating	Unit
$V_I$	Input Voltage	9	V
$T_J$	Operating Junction Temperature Range Control Section Power Transistor	0 to 125 0 to 150	°C
$T_{STG}$	Storage Temperature Range	-65 to +150	°C
$T_L$	Lead Temperature (Soldering, 10 second)	260	°C
$\theta_{JA}$	Thermal Resistance from Junction to Ambient in Free Air SOT-89 SOT-223 TO-92 TO-252	180 75 180 62.5	°C/W

Electrical Characteristics

Symbol	Parameter	Test Conditions	APL1087E			Unit
			Min.	Typ.	Max.	
$V_{REF}$	Reference Voltage	$10mA \leq I_{OUT} \leq 0.5A$ , $3.1V \leq V_{IN} \leq 9V$ , $T_J = 0 \sim 125^\circ C$	1.225	1.250	1.275	V
$V_{OUT}$	Output Voltage APL1087E-18	$T_J = 0 \sim 125^\circ C$ , $0 \leq I_{OUT} \leq 0.5A$ , $3.25V \leq V_{IN} \leq 9V$ ,	1.764	1.800	1.836	V
	APL1087E-25	$T_J = 0 \sim 125^\circ C$ , $0 \leq I_{OUT} \leq 0.5A$ , $3.95V \leq V_{IN} \leq 9V$ ,	2.450	2.500	2.550	
	APL1087E-33	$T_J = 0 \sim 125^\circ C$ , $0 \leq I_{OUT} \leq 0.5A$ , $4.75V \leq V_{IN} \leq 9V$ ,	3.235	3.300	3.365	
$REG_{LINE}$	Line Regulation APL1087E	$T_J = 0 \sim 125^\circ C$ $I_{OUT} = 10mA$ , $3.1V \leq V_{IN} \leq 9V$ , (note 1)		0.03	0.2	%
	APL1087E-18	$I_{OUT} = 0mA$ , $3.25V \leq V_{IN} \leq 9V$ , (note 1)		1	6	mV
	APL1087E-25	$I_{OUT} = 0A$ , $3.95V \leq V_{IN} \leq 9V$ , (note 1)		1	6	
	APL1087E-33	$I_{OUT} = 0A$ , $4.75V \leq V_{IN} \leq 9V$ , (note 1)		1	6	
$REG_{LOAD}$	Load Regulation APL1087E	$T_J = 0 \sim 125^\circ C$ $(V_{IN} - V_{OUT}) = 3V$ , $0 \leq I_{OUT} \leq 0.5A$ , (note 1)		0.4	0.6	%
	APL1087E-18	$V_{IN} = 3.25V$ , $0 \leq I_{OUT} \leq 0.5A$ , (note 1)				
	APL1087E-25	$V_{IN} = 3.95V$ , $0 \leq I_{OUT} \leq 0.5A$ , (note 1)				
	APL1087E-33	$V_{IN} = 4.75V$ , $0 \leq I_{OUT} \leq 0.5A$ , (note 1)				
$V_D$	Dropout Voltage	$I_{OUT} = 0.5A$ , $T_J = 0 \sim 125^\circ C$		1.3	1.45	V
$I_{LIMIT}$	Current Limit	$(V_{IN} - V_{OUT}) = 5V$ , $T_J = 25^\circ C$	800			mA
$I_{ADJ}$	Adjust Pin Current	$(V_{IN} - V_{OUT}) = 3V$ , $I_{OUT} = 10mA$ , $T_J = 0 \sim 125^\circ C$		60	120	$\mu A$
$\Delta I_{ADJ}$	Adjust Pin Current Change	$T_J = 0 \sim 125^\circ C$ , $10mA \leq I_{OUT} \leq 0.5A$ , $1.45V \leq V_{IN} - V_{OUT} \leq 7.55V$		0.2	5	$\mu A$
$I_O$	Minimum Load Current	$T_J = 0 \sim 125^\circ C$ , $V_{IN} = 9V$ , (note 3)		1.7		mA
PSRR	Ripple Rejection	$F_{RIPPLE} = 120Hz$ , $V_{RIPPLE} = 1V_{P-P}$ , $(V_{IN} - V_{OUT}) = 3V$ , $T_J = 0 \sim 125^\circ C$	60	75		dB
$T_R$	Thermal Regulation	$T_J = 25^\circ C$ , 30ms Pulse		0.01	0.02	%/W
$T_S$	Temperature Stability			0.5		%
$L_S$	Long -Term Stability	$T_J = 125^\circ C$ , 1000Hrs.		0.3		%
$V_N$	RMS Output Noise	$T_J = 25^\circ C$ , $10Hz \leq F \leq 10kHz$ , (% of $V_{OUT}$ )		0.003		%
OT	Over Temperature Point			150		$^\circ C$
	Quiescent Current APL1087E-18 APL1087E-25 APL1087E-33	$T_J = 0 \sim 125^\circ C$ , $V_{IN} \leq 9V$ $V_{IN} \leq 9V$ $V_{IN} \leq 9V$		5.5 5.5 5.5	10 10 10	mA

## Electrical Characteristics (Cont.)

Note 1: See thermal regulation specifications for changes in output voltage due to heating effects. Load line regulations are measured at a constant junction temperature by low duty cycle pulse testing.

Note 2: Dropout voltage is specified over the full output current range of the device. Dropout voltage is defined as the minimum input/output differential measured at the specified output current. Test points and limits are also shown on the Dropout Voltage curve.

Note 3: Minimum load current is defined as the minimum output current required to maintain regulation.

## Application Circuits

### 1.25V to 7.15V Adjustable Regulator

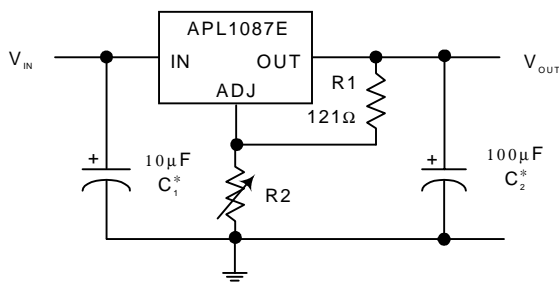

\* Needed if device is far from filter capacitors

$$V_{OUT} = 1.250V \times \frac{R1 + R2}{R1}$$

### Improving Ripple Rejection

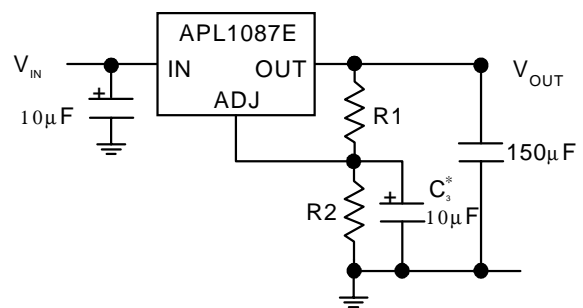

\* C3 improves ripple rejection.

Xc should be approximately equal to R1 at ripple frequency

### 5V Regulator with Shutdown

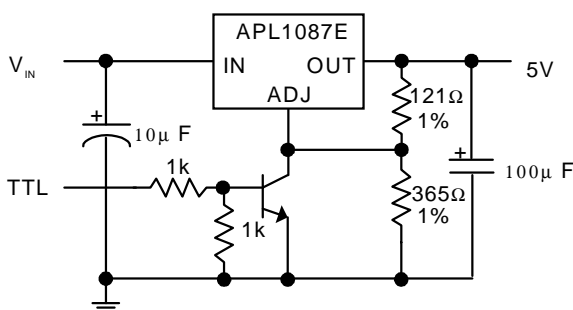

## Typical Characteristics

Load Transient Response

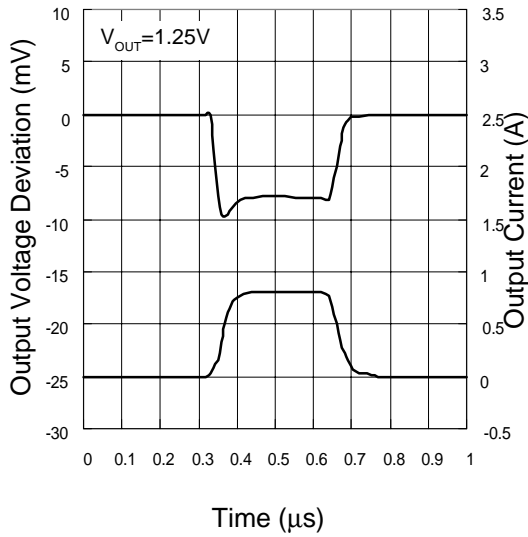

Line Transient Response

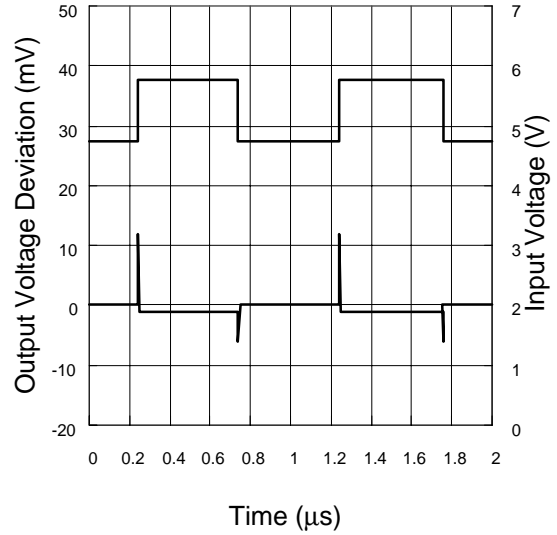

Adjust Pin Current vs. Temperature

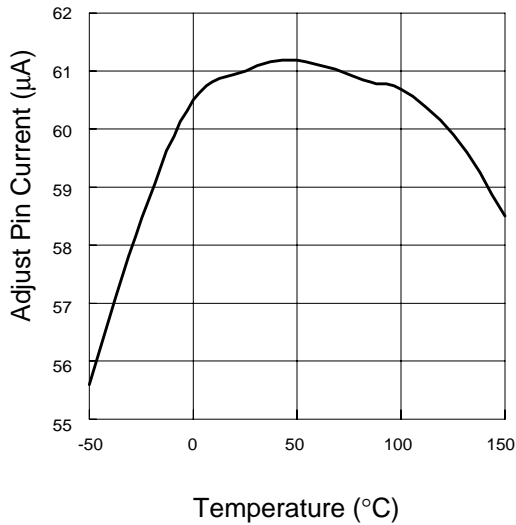

Current Limit vs. Temperature

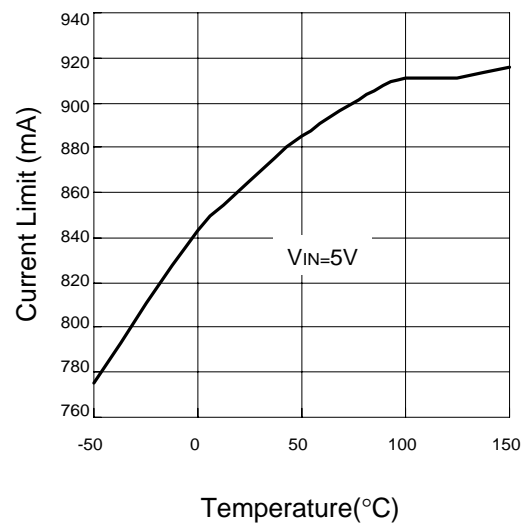

Typical Characteristics (Cont.)

Dropout Voltage vs. Temperature

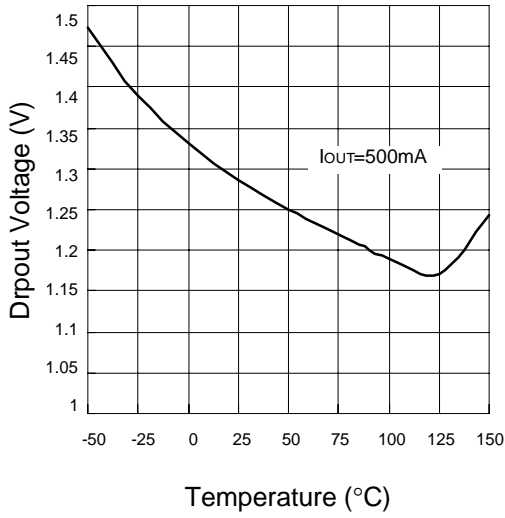

Reference Voltage vs. Temperature

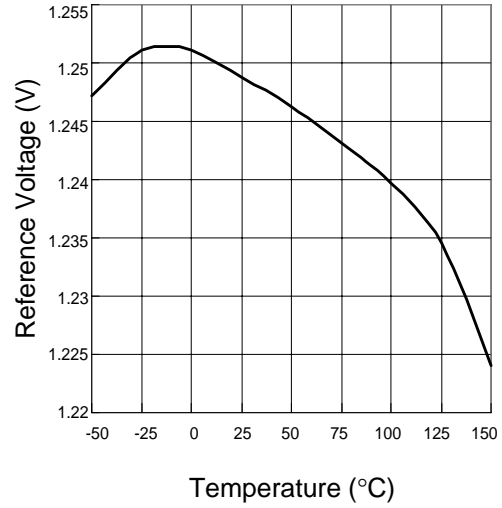

Output Voltage vs. Temperature

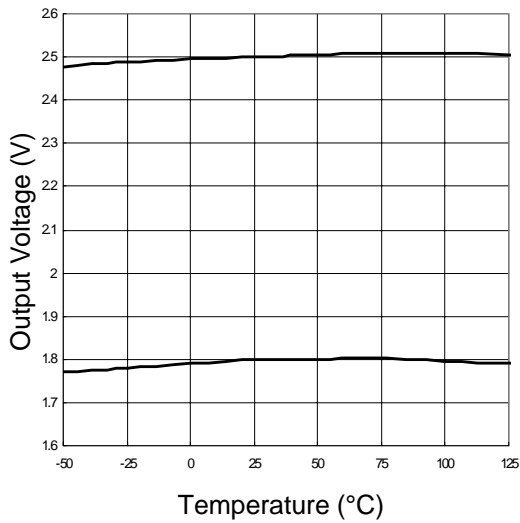

Output Voltage vs. Temperature

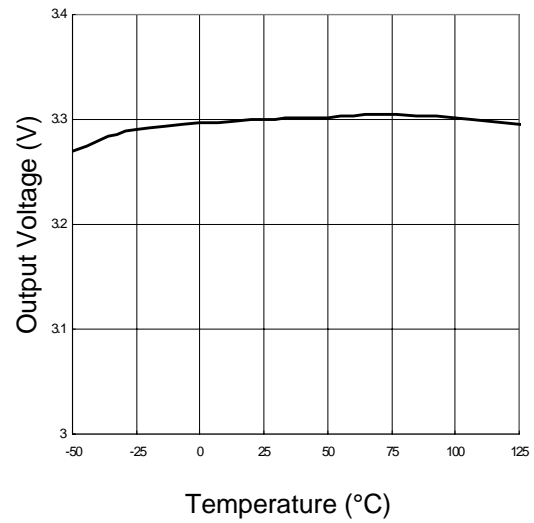

Typical Characteristics (Cont.)

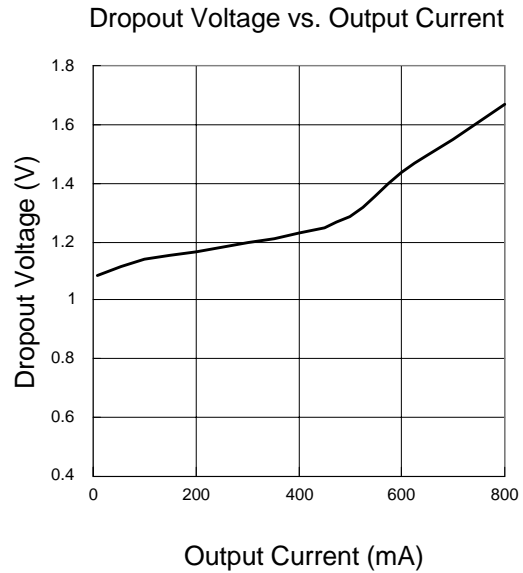
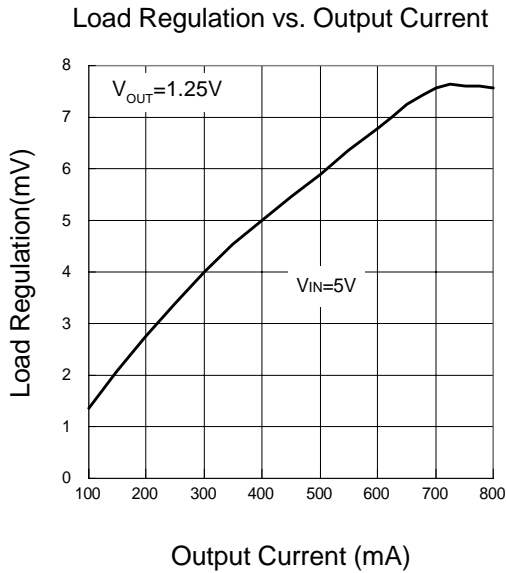
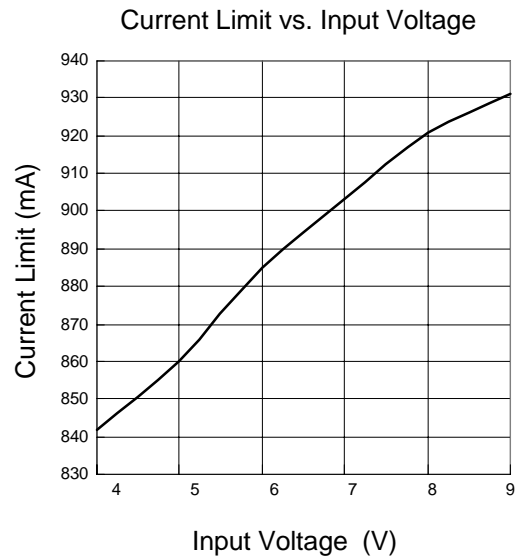
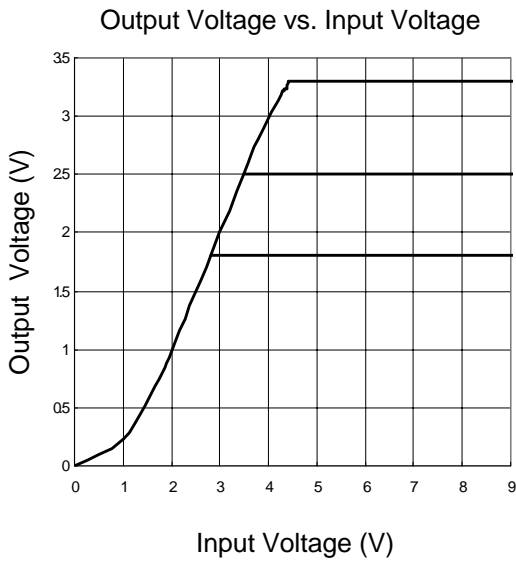

## Package Information

SOT-89 (Reference EIAJ ED-7500A Registration SC-62)

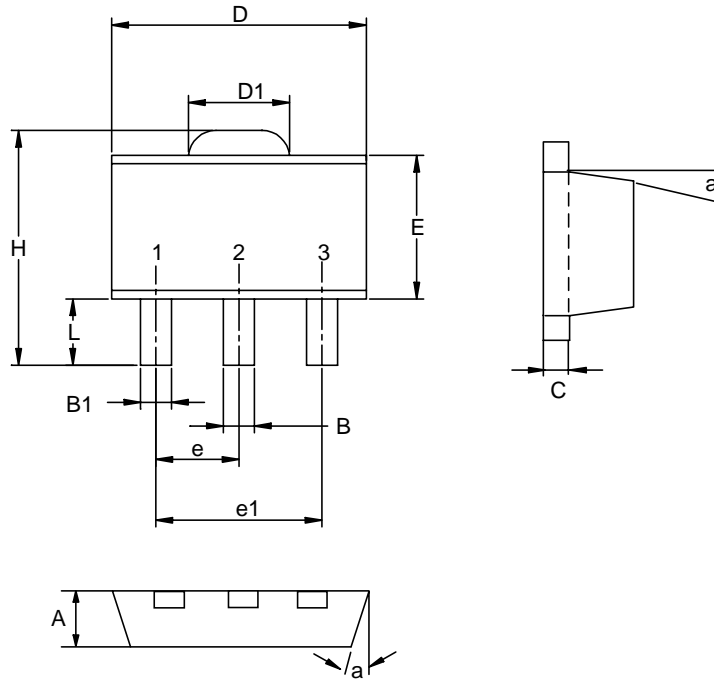

Dim	Millimeters		Inches	
	Min.	Max.	Min.	Max.
A	1.40	1.60	0.055	0.063
B	0.40	0.56	0.016	0.022
B1	0.35	0.48	0.014	0.019
C	0.35	0.44	0.014	0.017
D	4.40	4.60	0.173	0.181
D1	1.35	1.83	0.053	0.072
e	1.50 BSC		0.059 BSC	
e1	3.00 BSC		0.118 BSC	
E	2.29	2.60	0.090	0.102
H	3.75	4.25	0.148	0.167
L	0.80	1.20	0.031	0.047
α		10°		10°



Package Information

SOT-223( Reference JEDEC Registration SOT-223)

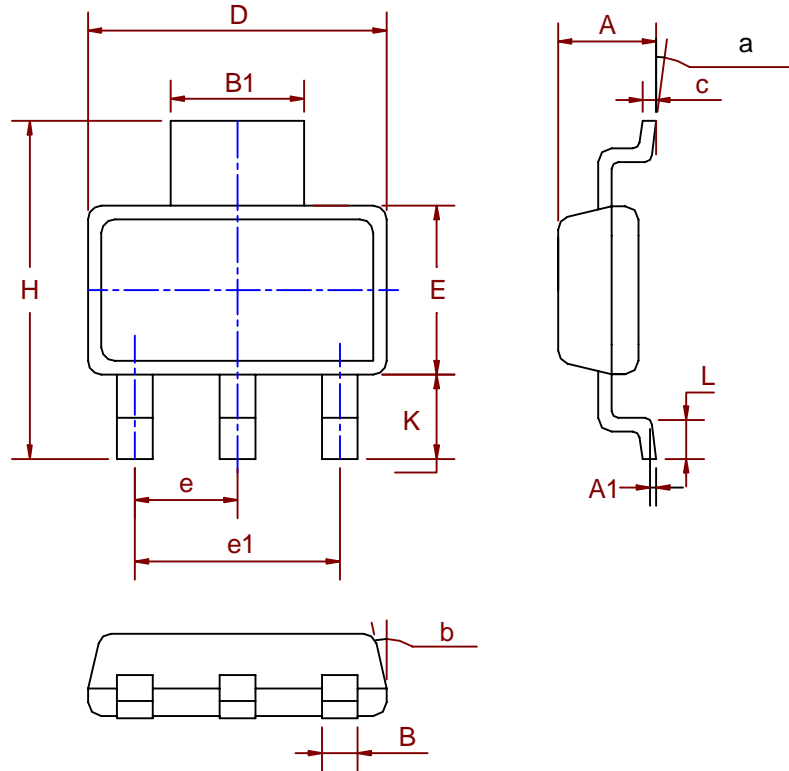

Dim	Millimeters		Inches	
	Min.	Max.	Min.	Max.
A	1.50	1.80	0.06	0.07
A1	0.02	0.08		
B	0.60	0.80	0.02	0.03
B1	2.90	3.10	0.11	0.12
c	0.28	0.32	0.01	0.01
D	6.30	6.70	0.25	0.26
E	3.30	3.70	0.13	0.15
e	2.3 BSC		0.09 BSC	
e1	4.6 BSC		0.18 BSC	
H	6.70	7.30	0.26	0.29
L	0.91	1.10	0.04	0.04
K	1.50	2.00	0.06	0.08
α	0°	10°	0°	10°
β	13°		13°	

Package Information

TO-92

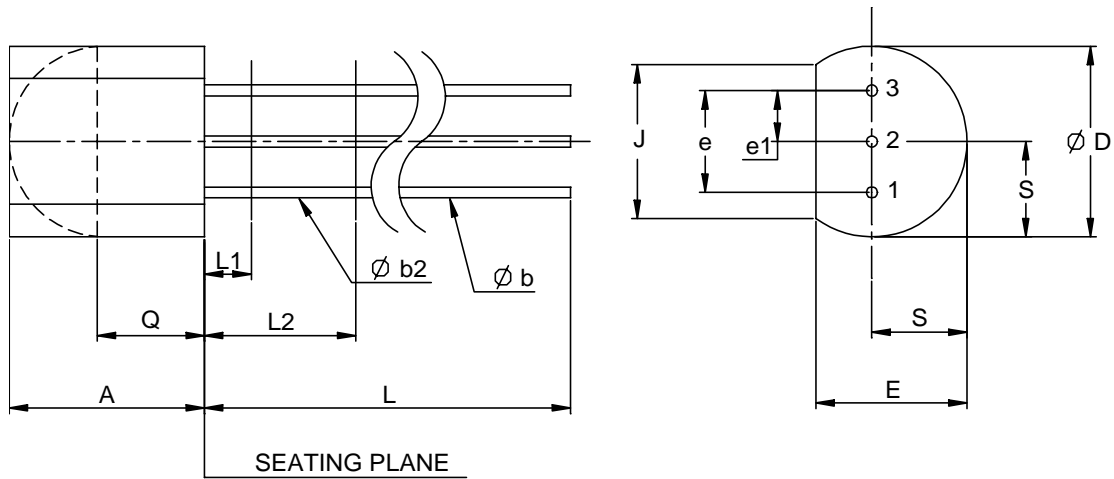

Dim	Millimeters		Inches	
	Min.	Max.	Min.	Max.
A	4.58	5.33	0.170	0.210
phi b	0.41	0.53	0.160	0.021
phi b2	0.41	0.48	0.160	0.019
phi D	4.96	5.20	0.175	0.205
E	3.94	4.19	0.125	0.165
e	2.42	2.66	0.095	0.105
e1	1.15	1.39	0.045	0.055
J	3.43		0.135	
L	12.70		0.500	
L1		1.27		0.050
L2	6.35		0.250	
Q	2.93		0.115	
S	2.42	2.66	0.080	0.105

Package Informaion

TO-252( Reference JEDEC Registration TO-252)

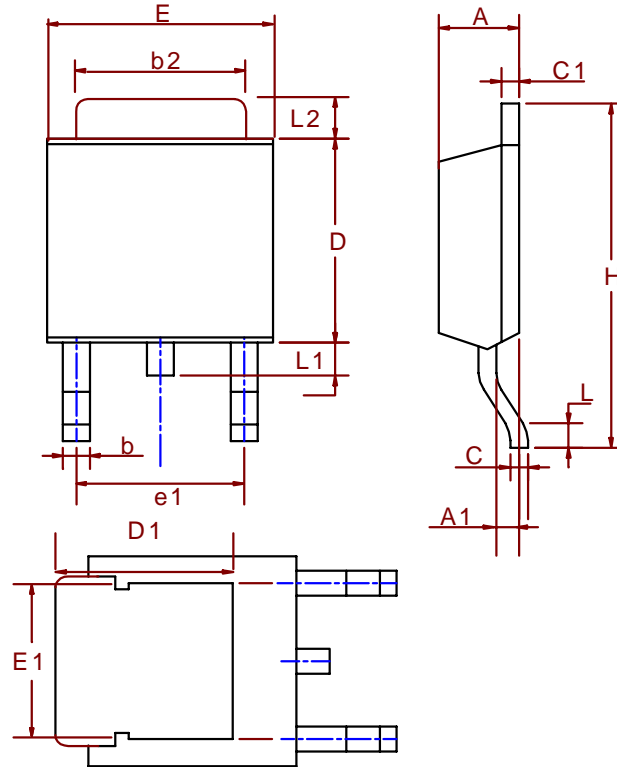

Dim	Millimeters		Inches	
	Min.	Max.	Min.	Max.
A	2.18	2.39	0.086	0.094
A1	0.89	1.27	0.035	0.050
b	0.508	0.89	0.020	0.035
b2	5.207	5.461	0.205	0.215
C	0.46	0.58	0.018	0.023
C1	0.46	0.58	0.018	0.023
D	5.334	6.22	0.210	0.245
D1	5.2 REF		0.205 REF	
E	6.35	6.73	0.250	0.265
E1	5.3 REF		0.209 REF	
e1	3.96	5.18	0.156	0.204
H	9.398	10.41	0.370	0.410
L	0.51		0.020	
L1	0.64	1.02	0.025	0.040
L2	0.89	2.032	0.035	0.080

## Physical Specifications

Terminal Material	Solder-Plated Copper (Solder Material : 90/10 or 63/37 SnPb).
Lead Solderability	Meets EIA Specification RSI86-91, ANSI/J-STD-002 Category 3.

## Reflow Condition (IR/Convection or VPR Reflow)

Reference JEDEC Standard J-STD-020A APRIL 1999

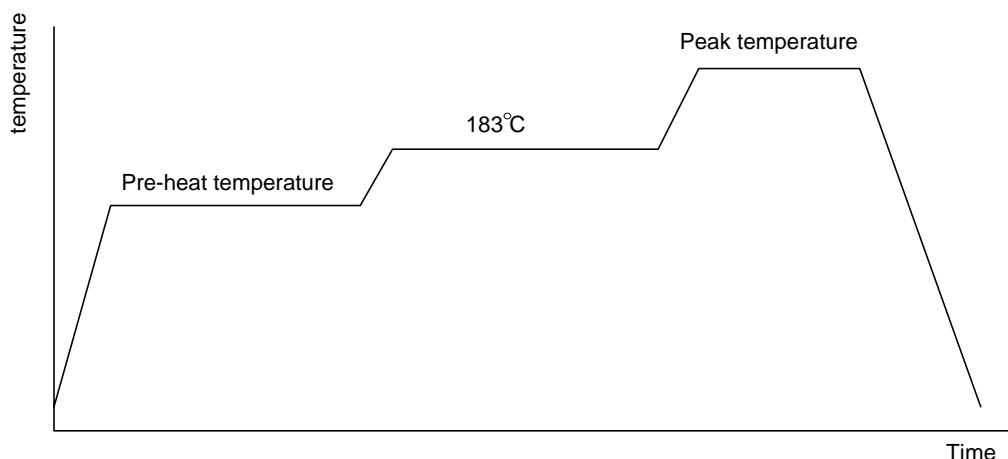

## Classification Reflow Profiles

	Convection or IR/ Convection	VPR
Average ramp-up rate(183°C to Peak)	3°C/second max.	10 °C /second max.
Preheat temperature 125 ± 25°C)	120 seconds max.	
Temperature maintained above 183°C	60 ~ 150 seconds	
Time within 5°C of actual peak temperature	10 ~ 20 seconds	60 seconds
Peak temperature range	220 +5/-0°C or 235 +5/-0°C	215~ 219°C or 235 +5/-0°C
Ramp-down rate	6 °C /second max.	10 °C /second max.
Time 25°C to peak temperature	6 minutes max.	

## Package Reflow Conditions

pkg. thickness ≥ 2.5mm and all bags	pkg. thickness < 2.5mm and pkg. volume ≥ 350 mm <sup>3</sup>	pkg. thickness < 2.5mm and pkg. volume < 350mm <sup>3</sup>
Convection 220 +5/-0 °C		Convection 235 +5/-0 °C
VPR 215-219 °C		VPR 235 +5/-0 °C
IR/Convection 220 +5/-0 °C		IR/Convection 235 +5/-0 °C

## Reliability test program

Test item	Method	Description
SOLDERABILITY	MIL-STD-883D-2003	245°C , 5 SEC
HOLT	MIL-STD-883D-1005.7	1000 Hrs Bias @ 125 °C
PCT	JESD-22-B, A102	168 Hrs, 100 % RH , 121°C
TST	MIL-STD-883D-1011.9	-65°C ~ 150°C, 200 Cycles
ESD	MIL-STD-883D-3015.7	VHBM > 2KV, VMM > 200V
Latch-Up	JESD 78	10ms , I <sub>tr</sub> > 100mA

## Carrier Tape & Reel Dimensions

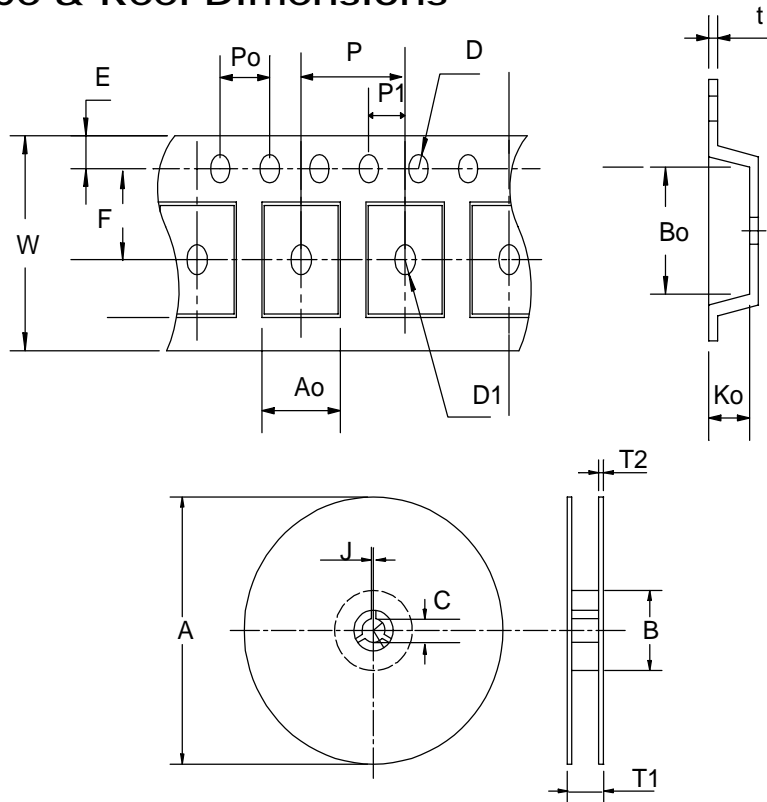

Application	A	B	C	J	T1	T2	W	P	E
SOT-89	178 ± 1	70 ± 2	13.5 ± 0.15	3 ± 0.15	14 ± 2	1.3 ± 0.3	12 + 0.3 12 - 0.1	8 ± 0.1	1.75 ± 0.1
	F	D	D1	Po	P1	Ao	Bo	Ko	t
	5.5 ± 0.05	1.5 ± 0.1	1.5 ± 0.1	4.0 ± 0.1	2.0 ± 0.1	4.8 ± 0.1	4.5 ± 0.1	1.80 ± 0.1	0.3 ± 0.013
Application	A	B	C	J	T1	T2	W	P	E
SOT-223	330 ± 1	62 ± 1.5	12.75 ± 0.15	2 ± 0.6	12.4 + 0.2	2 ± 0.2	12 ± 0.3	8 ± 0.1	1.75 ± 0.1
	F	D	D1	Po	P1	Ao	Bo	Ko	t
	5.5 ± 0.05	1.5 ± 0.1	1.5 ± 0.1	4.0 ± 0.1	2.0 ± 0.05	6.9 ± 0.1	7.5 ± 0.1	2.1 ± 0.1	0.3 ± 0.05
Application	A	B	C	J	T1	T2	W	P	E
TO-252	330 ± 3	100 ± 2	13 ± 0.5	2 ± 0.5	16.4 + 0.3 - 0.2	2.5 ± 0.5	16 + 0.3 - 0.1	8 ± 0.1	1.75 ± 0.1
	F	D	D1	Po	P1	Ao	Bo	Ko	t
	7.5 ± 0.1	1.5 ± 0.1	1.5 ± 0.25	4.0 ± 0.1	2.0 ± 0.1	6.8 ± 0.1	10.4 ± 0.1	2.5 ± 0.1	0.3 ± 0.05

(mm)

## Cover Tape Dimensions

Application	Carrier Width	Cover Tape Width	Devices Per Reel
SOT- 89	12	9.3	1000
SOT- 223	12	9.3	2500
TO- 252	16	13.3	2500

## Customer Service

### Anpec Electronics Corp.

Head Office :

5F, No. 2 Li-Hsin Road, SBIP,

Hsin-Chu, Taiwan, R.O.C.

Tel : 886-3-5642000

Fax : 886-3-5642050

Taipei Branch :

7F, No. 137, Lane 235, Pac Chiao Rd.,

Hsin Tien City, Taipei Hsien, Taiwan, R. O. C.

Tel : 886-2-89191368

Fax : 886-2-89191369