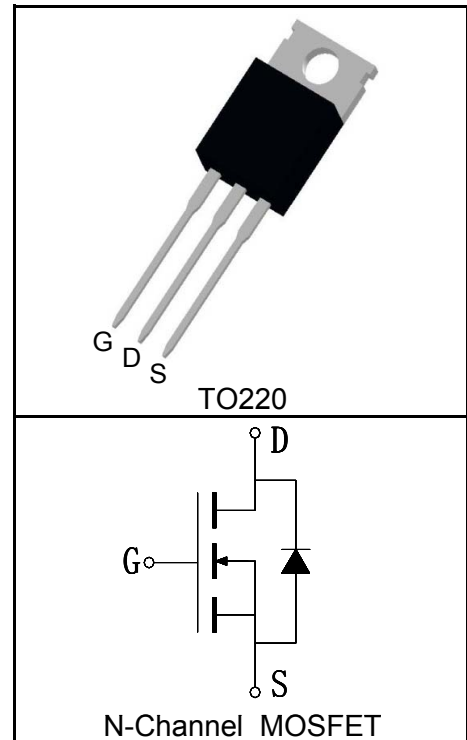

**Features**

- 75V/210A,  
 $R_{DS(ON)} = 3.5m\Omega(Typ.)@V_{GS}=10V$
- Reliable and Rugged
- 100% avalanche tested
- 175°C Operating Temperature
- Lead Free and Green Devices Available (RoHS Compliant)

**Applications**

- High Speed Power Switching
- High Efficiency Synchronous in SMPS
- Automotive applications and a wide variety of other applications

**Pin Description**

**Absolute Maximum Ratings**

Symbol	Parameter	Rating	Unit
<b>Common Ratings</b> ( $T_C=25^\circ C$ Unless Otherwise Noted)			
$V_{DSS}$	Drain-Source Voltage	75	V
$V_{GSS}$	Gate-Source Voltage	$\pm 25$	
$T_J$	Maximum Junction Temperature	175	$^\circ C$
$T_{STG}$	Storage Temperature Range	-55 to 175	$^\circ C$
$I_S$	Diode Continuous Forward Current	$T_C=25^\circ C$ 210	A
<b>Mounted on Large Heat Sink</b>			
$I_{DP}^{①}$	300 $\mu s$ Pulse Drain Current Tested	$T_C=25^\circ C$ 840	A
$I_D^{②}$	Continuous Drain Current( $V_{GS}=10V$ )	$T_C=25^\circ C$ 210	A
		$T_C=100^\circ C$ 148	
$P_D$	Maximum Power Dissipation	$T_C=25^\circ C$ 375	W
		$T_C=100^\circ C$ 188	
$R_{\theta JC}$	Thermal Resistance-Junction to Case	0.4	$^\circ C/W$
$R_{\theta JA}$	Thermal Resistance-Junction to Ambient	62.5	$^\circ C/W$
<b>Drain-Source Avalanche Ratings</b>			
$E_{AS}^{③}$	Avalanche Energy, Single Pulsed	900	mJ

**Electrical Characteristics** ( $T_C=25^{\circ}\text{C}$  Unless Otherwise Noted)

Symbol	Parameter	Test Condition	RU75210R			Unit
			Min.	Typ.	Max.	
<b>Static Characteristics</b>						
$BV_{DSS}$	Drain-Source Breakdown Voltage	$V_{GS}=0V, I_{DS}=250\mu A$	75			V
$I_{DSS}$	Zero Gate Voltage Drain Current	$V_{DS}=75V, V_{GS}=0V$			1	$\mu A$
		$T_J=125^{\circ}\text{C}$			30	
$V_{GS(th)}$	Gate Threshold Voltage	$V_{DS}=V_{GS}, I_{DS}=250\mu A$	2	3	4	V
$I_{GSS}$	Gate Leakage Current	$V_{GS}=\pm 25V, V_{DS}=0V$			$\pm 100$	nA
$R_{DS(ON)}^{(4)}$	Drain-Source On-state Resistance	$V_{GS}=10V, I_{DS}=75A$		3.5	4.5	m $\Omega$
<b>Diode Characteristics</b>						
$V_{SD}^{(4)}$	Diode Forward Voltage	$I_{SD}=75A, V_{GS}=0V$			1.2	V
$t_{rr}$	Reverse Recovery Time	$I_{SD}=75A, di_{SD}/dt=100A/\mu s$		62		ns
$Q_{rr}$	Reverse Recovery Charge			84		nC
<b>Dynamic Characteristics</b> <sup>(5)</sup>						
$R_G$	Gate Resistance	$V_{GS}=0V, V_{DS}=0V, F=1\text{MHz}$		1.2		$\Omega$
$C_{iss}$	Input Capacitance	$V_{GS}=0V,$ $V_{DS}=37.5V,$ Frequency=1.0MHz		7400		pF
$C_{oss}$	Output Capacitance			1050		
$C_{riss}$	Reverse Transfer Capacitance			480		
$t_{d(ON)}$	Turn-on Delay Time		$V_{DD}=37.5V, I_{DS}=75A,$ $V_{GEN}=10V, R_G=6\Omega$		46	
$t_r$	Turn-on Rise Time			85		
$t_{d(OFF)}$	Turn-off Delay Time			42		
$t_f$	Turn-off Fall Time			28		
<b>Gate Charge Characteristics</b> <sup>(5)</sup>						
$Q_g$	Total Gate Charge	$V_{DS}=60V, V_{GS}=10V,$ $I_{DS}=75A$		92		nC
$Q_{gs}$	Gate-Source Charge			24		
$Q_{gd}$	Gate-Drain Charge			28		

- Notes:
- ① Pulse width limited by safe operating area.
  - ② Calculated continuous current based on maximum allowable junction temperature. The package limitation current is 75A.
  - ③ Limited by  $T_{Jmax}$ ,  $I_{AS}=60A$ ,  $V_{DD}=48V$ ,  $R_G=50\Omega$ , Starting  $T_J=25^{\circ}\text{C}$ .
  - ④ Pulse test; Pulse width  $\leq 300\mu s$ , duty cycle  $\leq 2\%$ .
  - ⑤ Guaranteed by design, not subject to production testing.

**Ordering and Marking Information**

<b>Device</b>	<b>Marking</b>	<b>Package</b>	<b>Packaging</b>	<b>Quantity</b>	<b>Reel Size</b>	<b>Tape width</b>
RU75210R	RU75210R	TO220	Tube	50	-	-

**Typical Characteristics**

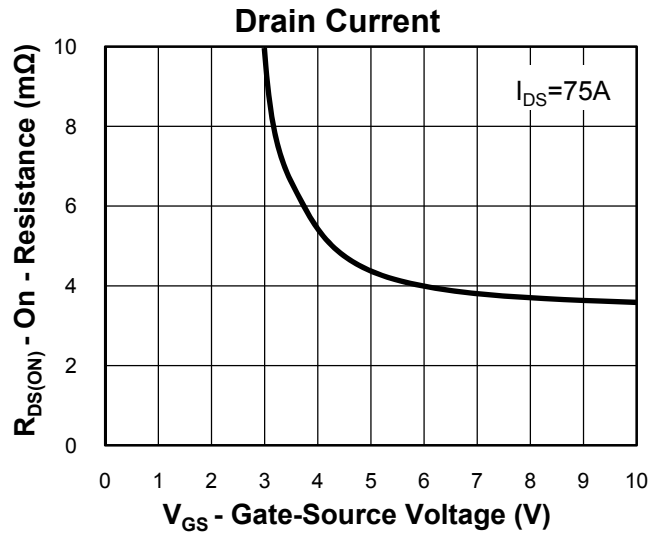
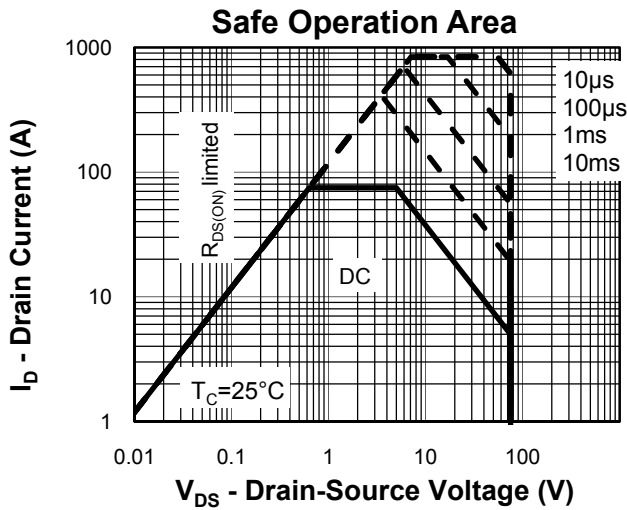
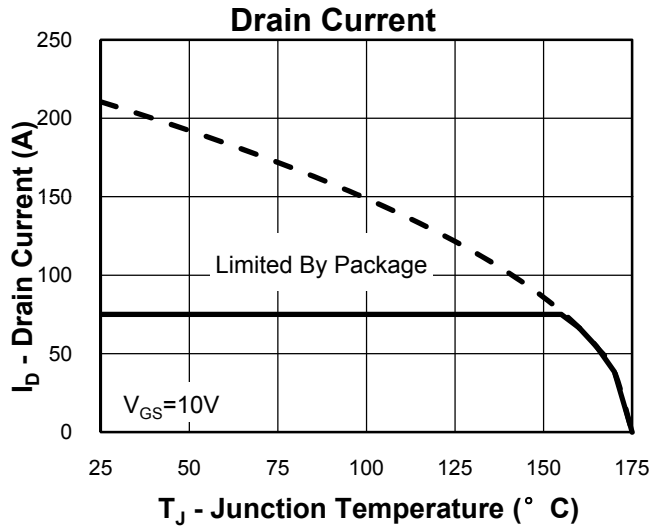
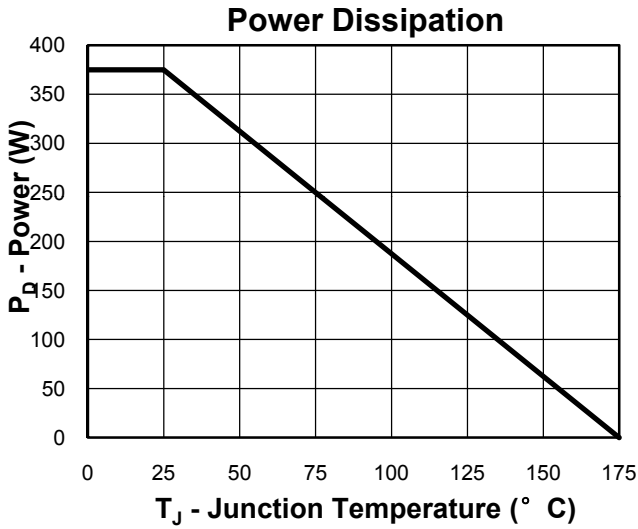

**Thermal Transient Impedance**

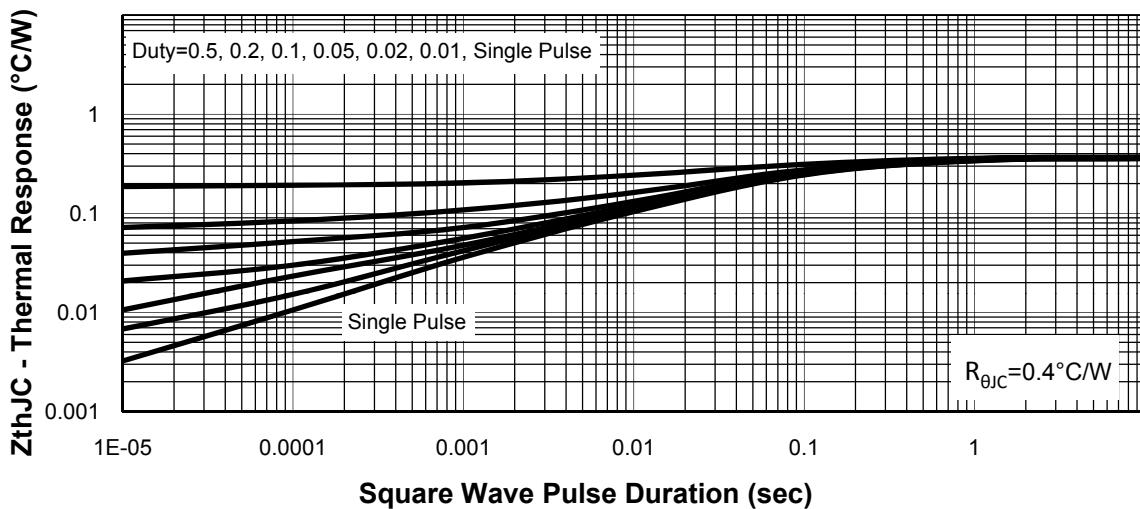

**Typical Characteristics**

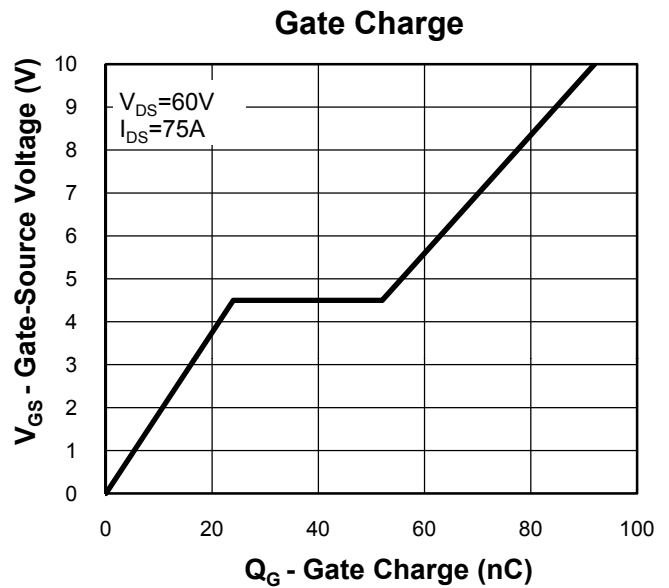
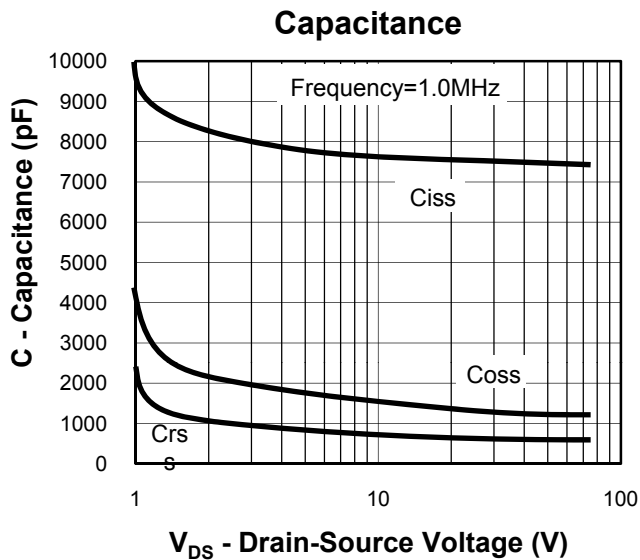
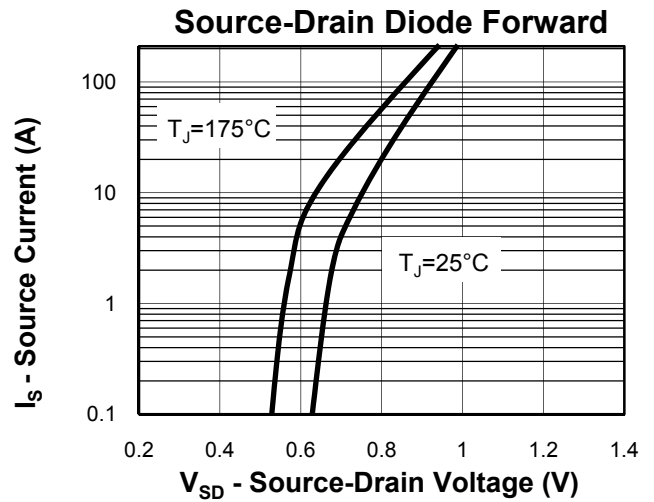
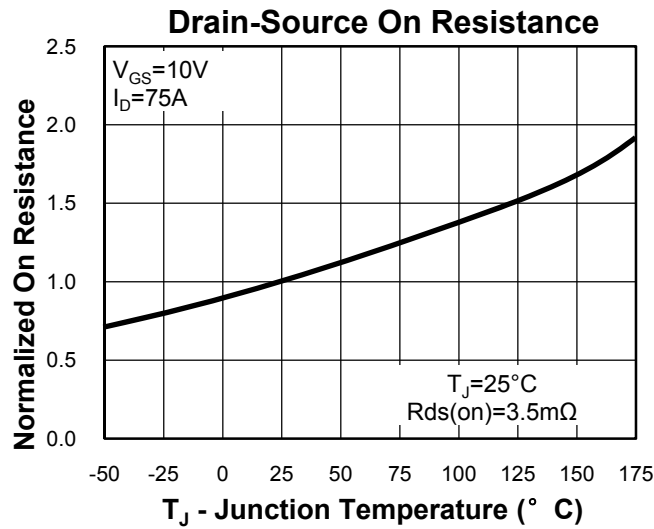
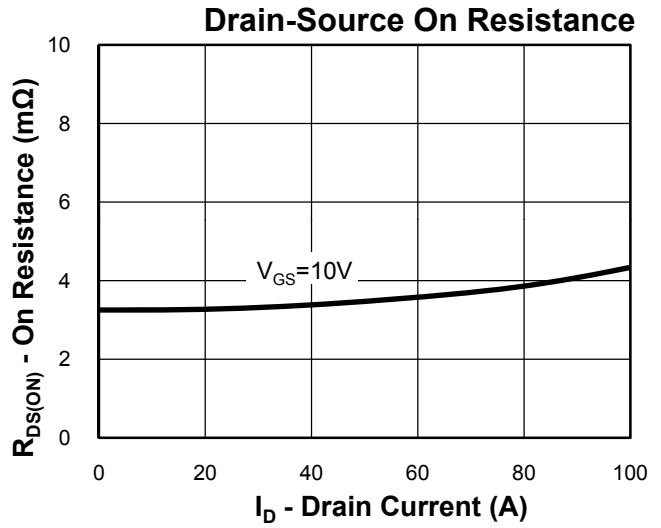
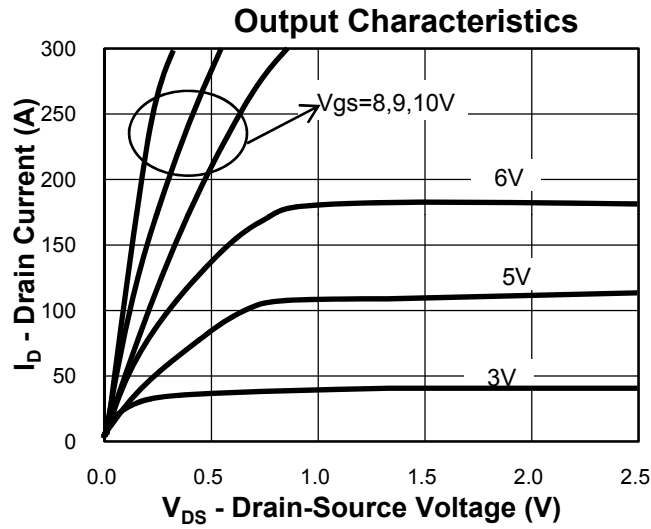

**Avalanche Test Circuit and Waveforms**

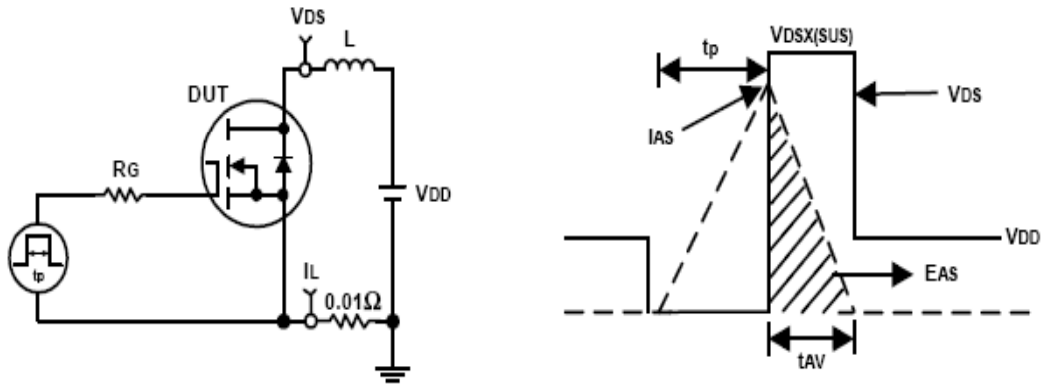

**Switching Time Test Circuit and Waveforms**

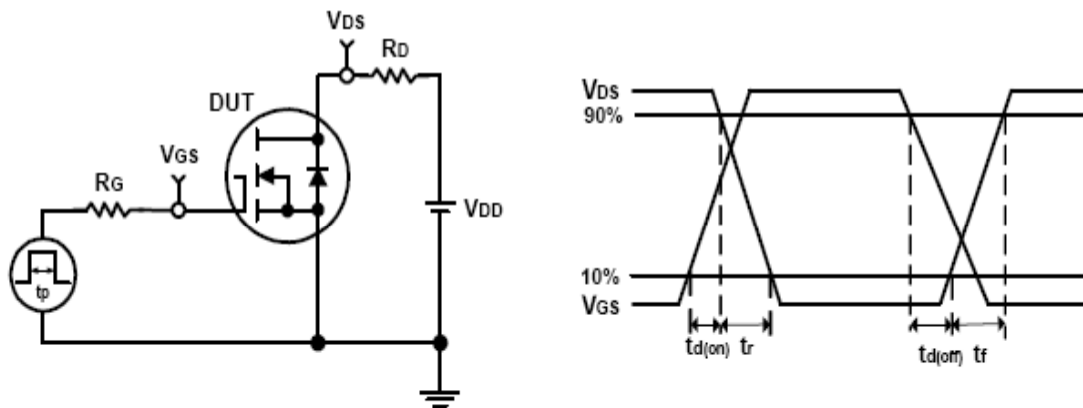

**Package Information**

**TO220**

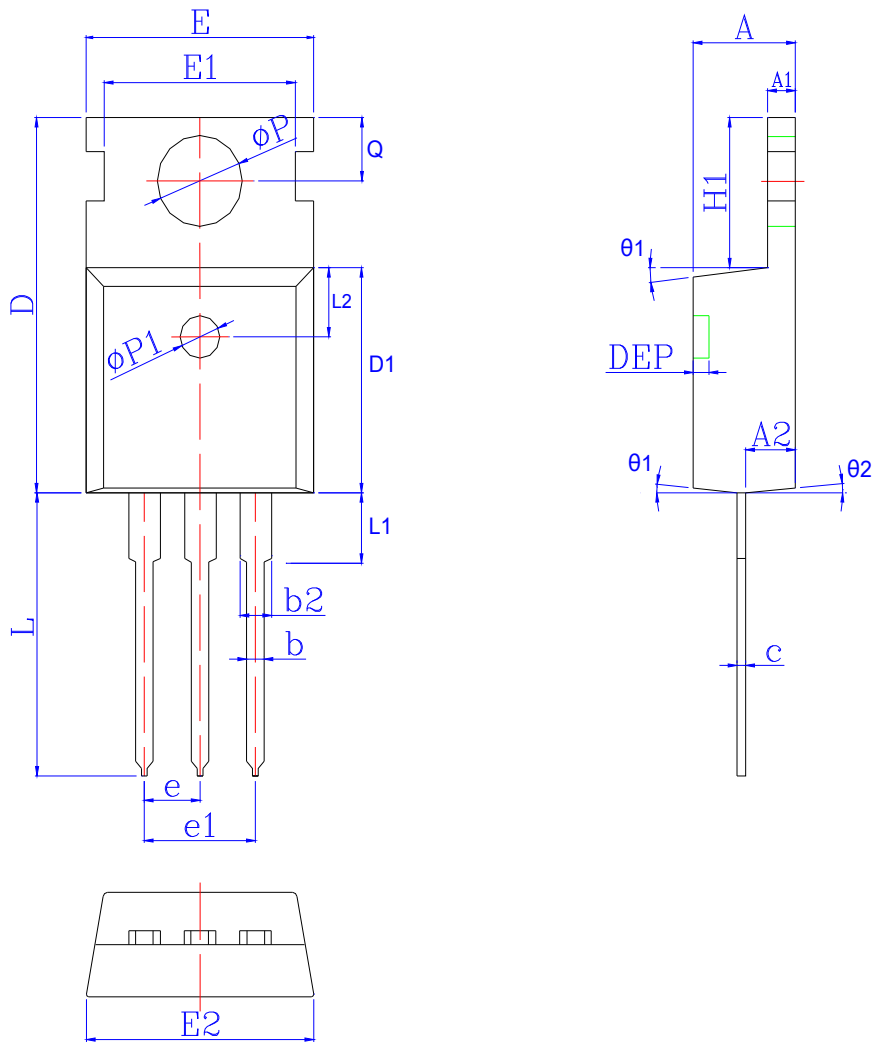

SYMBOL	MM			INCH			SYMBOL	MM			INCH		
	MIN	NOM	MAX	MIN	NOM	MAX		MIN	NOM	MAX	MIN	NOM	MAX
A	4.30	4.50	4.70	0.169	0.177	0.185	$\Phi p1$	1.40	1.50	1.60	0.055	0.059	0.063
A1	1.15	1.30	1.40	0.045	0.051	0.055	e	2.54 BSC			0.10 BSC		
A2	1.90	2.25	2.60	0.075	0.089	0.102	e1	5.08 BSC			0.20 BSC		
b	0.60	0.80	1.00	0.024	0.031	0.039	H1	6.35	6.50	6.80	0.250	0.256	0.268
b2	1.17	1.28	1.72	0.046	0.050	0.068	L	12.70	13.18	13.65	0.500	0.519	0.537
c	0.40	0.50	0.60	0.016	0.020	0.024	L1	*	*	3.95	*	*	0.156
D	15.40	15.70	16.00	0.606	0.618	0.630	L2	2.50 REF			0.098 REF		
D1	8.96	9.21	9.46	0.353	0.363	0.372	$\Phi p$	3.50	3.60	3.75	0.138	0.142	0.148
DEP	*	*	0.30	*	*	0.012	Q	2.70	2.80	3.20	0.106	0.110	0.126
E	9.66	9.97	10.28	0.380	0.393	0.405	$\theta 1$	5°	7°	9°	5°	7°	9°
E1	*	8.70	*	*	0.343	*	$\theta 2$	1°	3°	5°	1°	3°	5°
E2	9.80	10.00	10.20	0.386	0.394	0.402							

**Customer Service**

**Worldwide Sales and Service:**  
Sales@ruichips.com

**Technical Support:**  
Technical@ruichips.com

**Investor Relations Contacts:**  
Investor@ruichips.com

**Marcom Contact:**  
Marcom@ruichips.com

**Editorial Contact:**  
Editorial@ruichips.com

**HR Contact:**  
HR@ruichips.com

**Legal Contact:**  
Legal@ruichips.com

**Shen Zhen RUICHIPS Semiconductor CO., LTD**  
Room 501, the 5floor An Tong Industrial Building,  
NO.207 Mei Hua Road Fu Tian Area Shen Zhen City, CHINA

**TEL:** (86-755) 8311-5334  
**FAX:** (86-755) 8311-4278  
**E-mail:** Sales-SZ@ruichips.com