



UP2003

Power MOSFET

9A, 25V P-CHANNEL LOGIC LEVEL ENHANCEMENT MODE FIELD EFFECT TRANSISTOR

DESCRIPTION

The **UP2003** uses advanced trench technology to provide excellent $R_{DS(ON)}$, low gate charge and operation with low gate voltages. This device is suitable for use as a load switch or in PWM applications.

FEATURES

- * $R_{DS(ON)} < 35 \text{ m}\Omega$ @ $V_{GS} = -4.5 \text{ V}$, $I_D = -7 \text{ A}$
- * $R_{DS(ON)} < 20 \text{ m}\Omega$ @ $V_{GS} = -10 \text{ V}$, $I_D = -9 \text{ A}$

SYMBOL

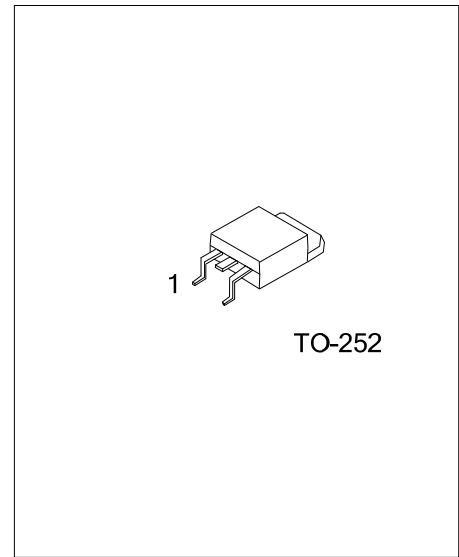
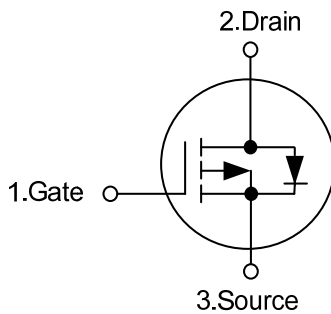

ORDERING INFORMATION

Ordering Number		Package	Pin Assignment			Packing
Lead Free	Halogen Free		1	2	3	
UP2003L-TN3-R	UP2003G-TN3-R	TO-252	G	D	S	Tape Reel

<p>UP2003L-TN3-R</p> <p>(1) Packing Type</p> <p>(2) Package Type</p> <p>(3) Green Package</p>	<p>(1) R: Tape Reel</p> <p>(2) TN3: TO-252</p> <p>(3) L: Lead Free, G: Halogen Free and Lead Free</p>
---	---

MARKING

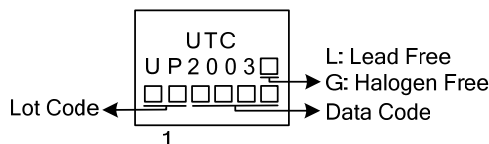

■ ABSOLUTE MAXIMUM RATINGS ($T_C = 25^\circ\text{C}$, unless otherwise specified)

PARAMETER	SYMBOL	RATINGS	UNIT
Drain Source Voltage	V_{DSS}	-25	V
Gate Source voltage	V_{GSS}	± 20	V
Continuous Drain Current	I_D	-9	A
Pulsed Drain Current (Note 1)	I_{DM}	-36	
Power Dissipation	P_D	2.5	W
Junction Temperature	T_J	+150	$^\circ\text{C}$
Storage Temperature	T_{STG}	-55 ~ +150	

Note: Absolute maximum ratings are those values beyond which the device could be permanently damaged.
Absolute maximum ratings are stress ratings only and functional device operation is not implied.

■ THERMAL DATA

PARAMETER	SYMBOL	MIN	TYP	MAX	UNIT
Junction-to-Ambient	θ_{JA}			50	$^\circ\text{C}/\text{W}$
Junction-to-Case	θ_{JC}			25	$^\circ\text{C}/\text{W}$

■ ELECTRICAL CHARACTERISTICS ($T_C = 25^\circ\text{C}$, unless otherwise specified)

PARAMETER	SYMBOL	TEST CONDITIONS	MIN	TYP	MAX	UNIT
OFF CHARACTERISTICS						
Drain-Source Breakdown Voltage	BV_{DSS}	$V_{GS} = 0\text{V}, I_D = -250\mu\text{A}$	-25			V
Drain Source Leakage Current	I_{DSS}	$V_{DS} = -25\text{V}, V_{GS} = 0\text{V}$			-1	μA
Gate-Body Leakage Current	I_{GSS}	$V_{DS} = 0\text{V}, V_{GS} = \pm 20\text{V}$			± 100	nA
ON CHARACTERISTICS						
Gate-Threshold Voltage	$V_{GS(TH)}$	$V_{DS} = V_{GS}, I_D = -250\mu\text{A}$	-1.0	-1.5	-3.0	V
On-State Drain Current (Note 2)	$I_{D(ON)}$	$V_{DS} = -5\text{V}, V_{GS} = -10\text{V}$	-50			A
Drain-Source On-Resistance (Note 2)	$R_{DS(ON)}$	$V_{GS} = -4.5\text{V}, I_D = -7\text{A}$		25	35	m Ω
		$V_{GS} = -10\text{V}, I_D = -9\text{A}$		15	20	
DYNAMIC PARAMETERS						
Input Capacitance	C_{ISS}	$V_{DS} = -15\text{V}, V_{GS} = 0\text{V}, f = 1\text{MHz}$		1610		pF
Output Capacitance	C_{OSS}			410		
Reverse Transfer Capacitance	C_{RSS}			200		
SWITCHING PARAMETERS (Note 3)						
Gate to Source Charge	Q_G	$V_{DS} = -12.5\text{V}_{(BR)DSS}, V_{GS} = -10\text{V}, I_D = -9\text{A}$		17	24	nC
Gate Charge at Threshold	Q_{GS}			5		
Gate to Drain Charge	Q_{GD}			6		
Turn-ON Delay Time	$t_{D(ON)}$	$V_{DS} = -12.5\text{V}, I_D = -1\text{A}, V_{GS} = -10\text{V}, R_{GS} = 6\Omega, R_L = 1\Omega$		6.2	9.3	ns
Turn-ON Rise Time	t_R			10		
Turn-OFF Delay Time	$t_{D(OFF)}$			18		
Turn-ON Delay Time	$t_{D(ON)}$			10		
Turn-OFF Fall-Time	t_F			5		
SOURCE- DRAIN DIODE RATINGS AND CHARACTERISTICS						
Diode Continuous Forward Current	I_S				-9	A
Diode Pulse Current (Note 1)	I_{SM}				-36	
Forward Voltage (Note 2)	V_{SD}	$I_F = I_S, V_{GS} = 0\text{V}$			-1.2	V

Note: 1. Pulse width limited by maximum junction temperature.
2. Pulse test: Pulse Width $\leq 300\mu\text{sec}$, Duty Cycle $\leq 2\%$
3. Independent of operating temperature.

■ TYPICAL CHARACTERISTICS

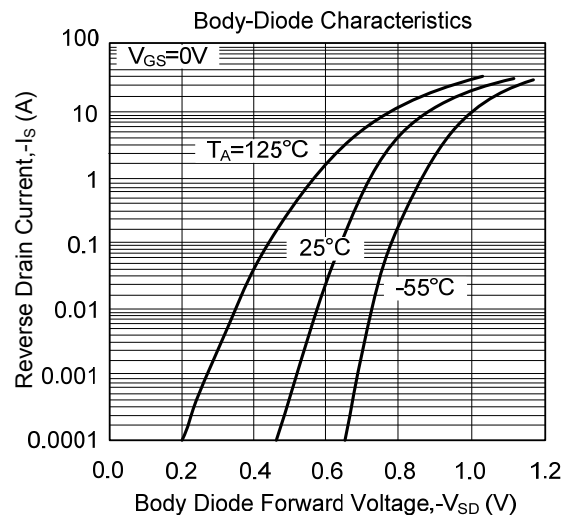
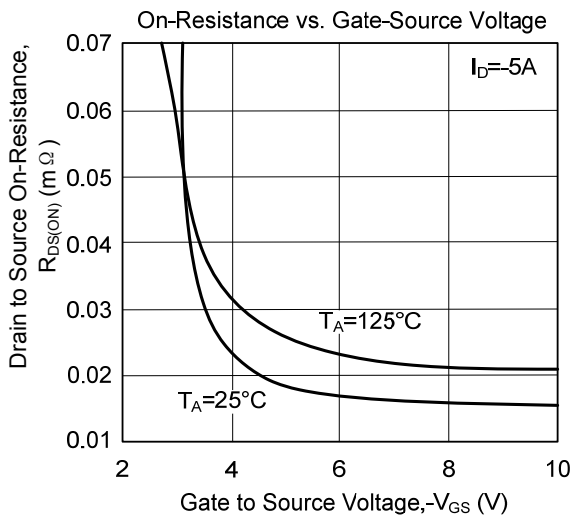
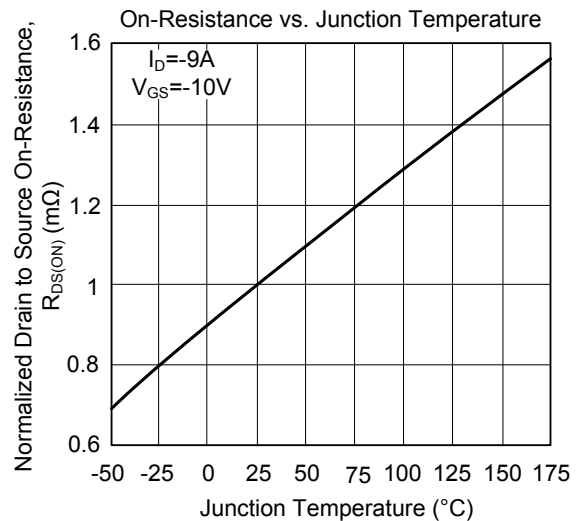
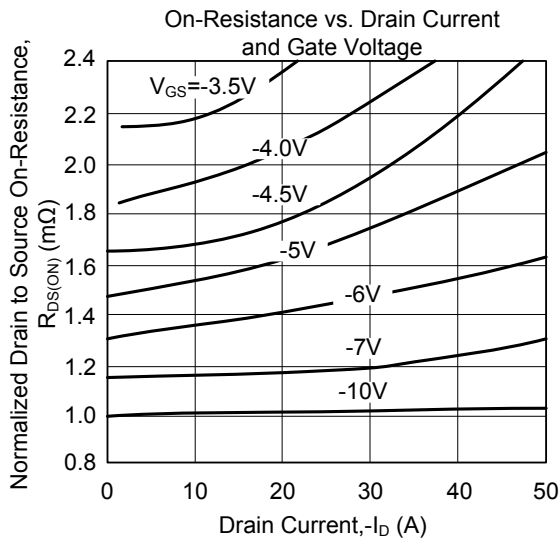
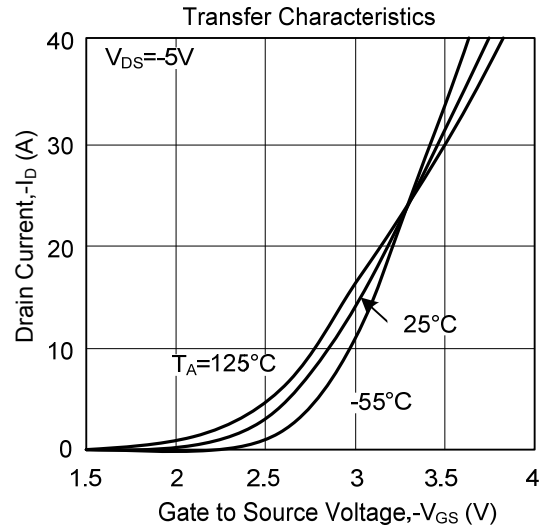
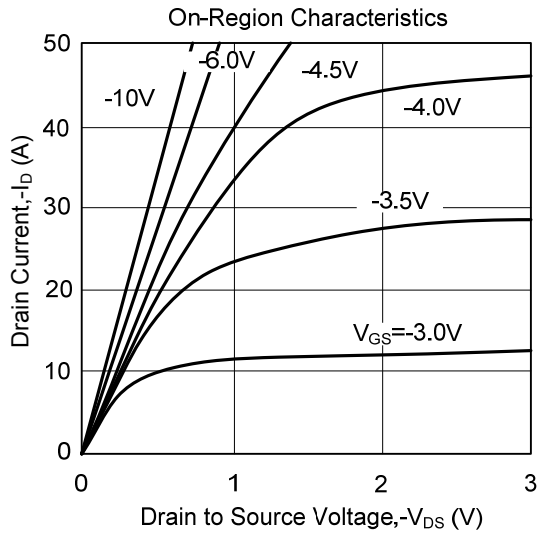

■ TYPICAL CHARACTERISTICS(Cont.)

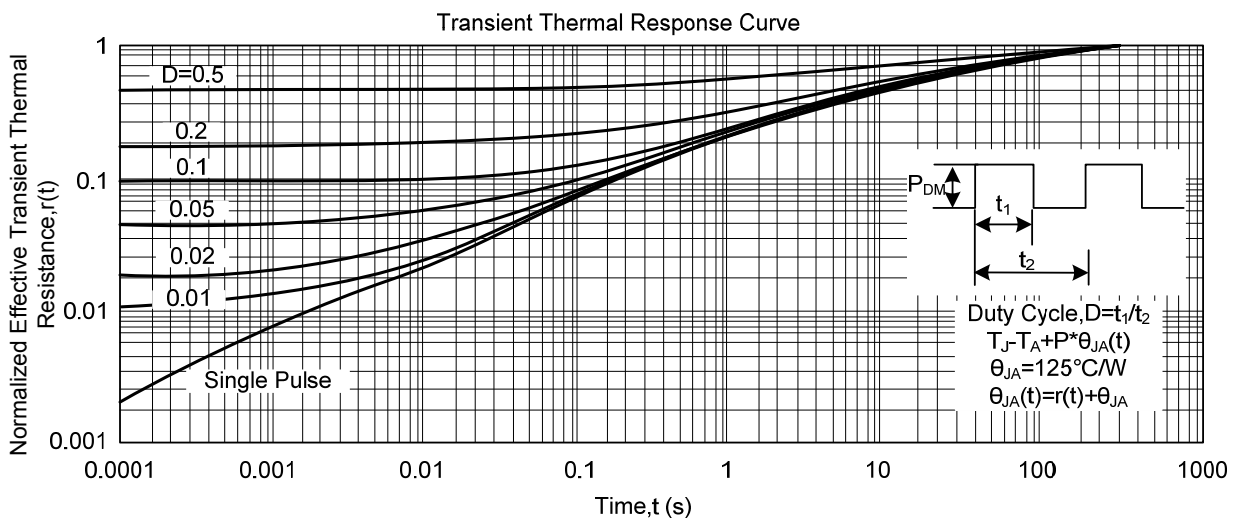
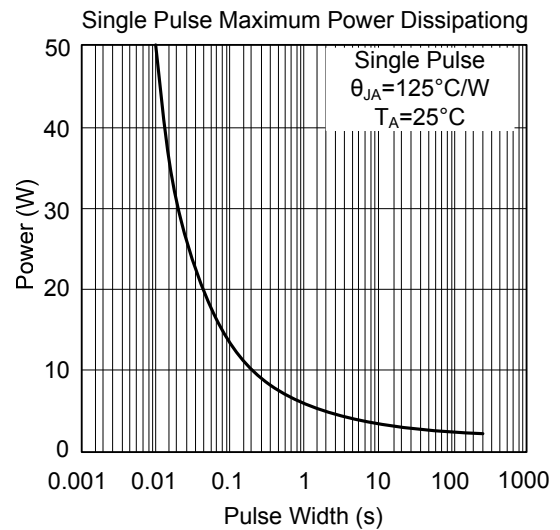
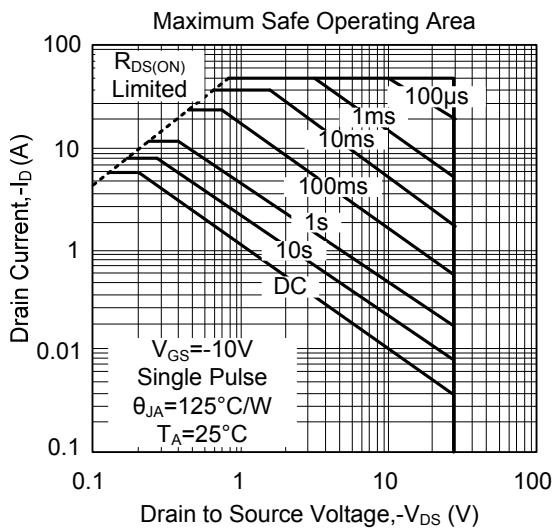
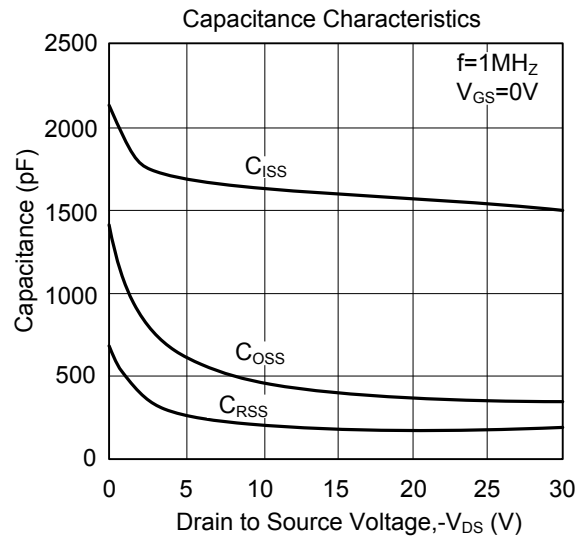
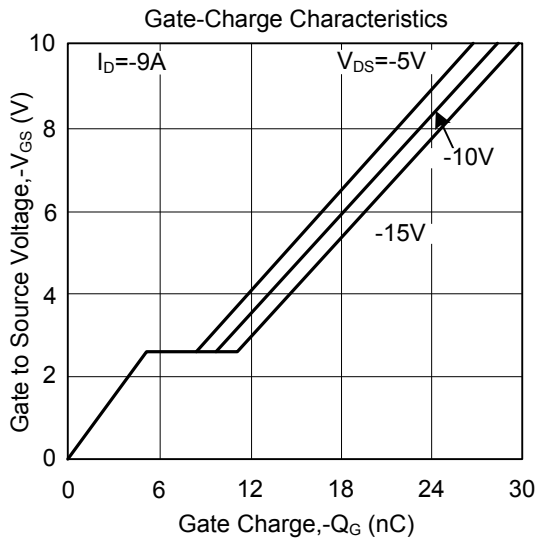

UTC assumes no responsibility for equipment failures that result from using products at values that exceed, even momentarily, rated values (such as maximum ratings, operating condition ranges, or other parameters) listed in products specifications of any and all UTC products described or contained herein. UTC products are not designed for use in life support appliances, devices or systems where malfunction of these products can be reasonably expected to result in personal injury. Reproduction in whole or in part is prohibited without the prior written consent of the copyright owner. The information presented in this document does not form part of any quotation or contract, is believed to be accurate and reliable and may be changed without notice.