

120mm sq.

San Ace 120

25mm thick (S type), 25mm thick (GV type)
 25mm thick (G type), 38mm thick (HV type)
38mm thick (GV type), 38mm thick (G type)
 38mm thick (SG type)



General Specifications

- Material Frame: Plastics (Flammability: UL94V-0),
 Impeller: Plastics (Flammability: UL94V-1)
- Expected Life Refer to specifications (L10:Survival rate:90% at 60°C ,
 rated voltage, and continuously run in a free air state)
- Lead Wire ⊕red ⊖black (Sensor) yellow (Control) brown
- Storage Temperature -30°C to +70°C (Non-condensing)

120×120×38mm (Mass : 360g) **GV type**

Specifications

The following nos. **have PWM controls, pulse sensors, and ribs.** For ribless, append "1" to the model no.

Model No.	Rated Voltage [V]	Operating Voltage Range [V]	PWM duty cycle※ [%]	Rated Current [A]	Rated Input [W]	Rated Speed [min ⁻¹]	Max. Air Flow [m ³ /min] [CFM]	Max. Static Pressure [Pa] [inchH ₂ O]	SPL [dB(A)]	Operating Temperature [°C]	Expected Life [h]
9GV1212P1J01	12	10.2 to 13.8	100 0	3.00 0.19	36.00 2.28	6,400 1,500	6.35 224.0 1.49 52.6	360.0 1.45 19.8 0.08	64 33	-20 to +70	40,000
9GV1224P1J01 ^(Note)	24	20.4 to 27.6	100	1.5	36.00	6,400	6.35 224.0	360 1.45	64		
9GV1224P1H01 ^(Note)			100	0.8	19.2	5,200	5.37 189	263 1.05	58		
9GV1248P1J01	48	40.8 to 55.2	100	0.75	36.00	6,400	6.35 224.0	360.0 1.45	64		
9GV1248P1B10 ^(Note)			0	0.06	2.88	1,500	1.49 52.6	26.1 0.106	33		
			100	0.43	20.64	5,250	5.12 180.9	242 0.97	59		

Note: Fan does not rotate when PWM duty cycle is 0%.

※ PWM Frequency : 25kHz
 9GV1248P1B10 only: 1.4 kHz

- Available options: ⇒ **Without Sensor** **Pulse Sensor**

Dimensions (Unit : mm) (With ribs)

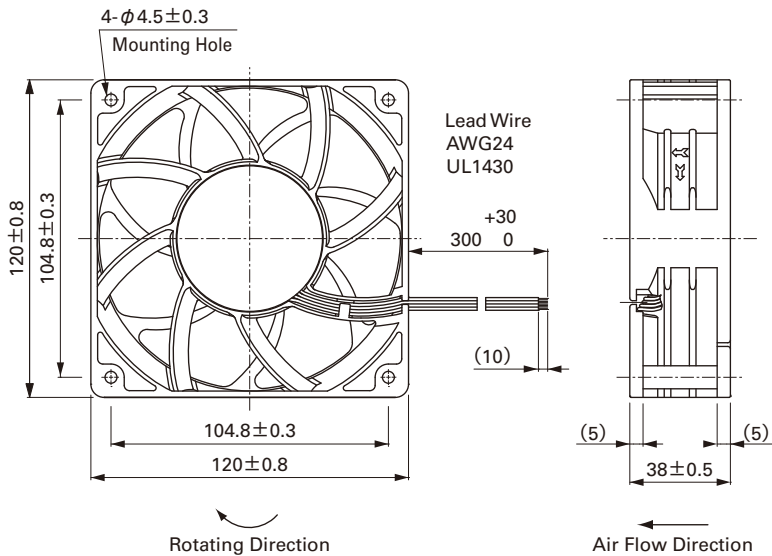

Reference dimension of mounting holes and vent opening (Unit : mm)

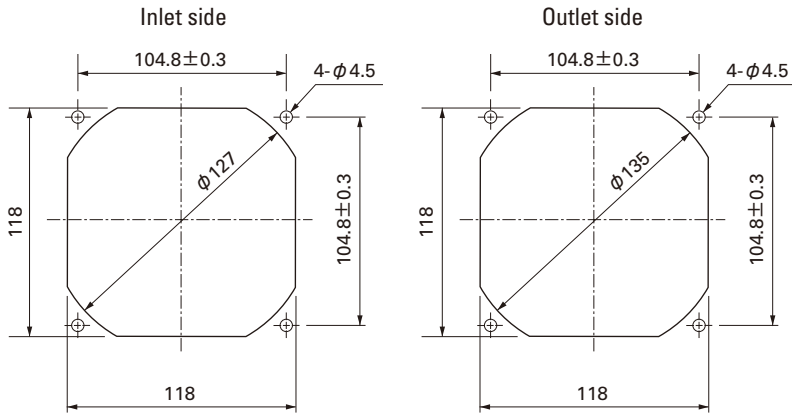

Options (Unit : mm)

Finger guards

Model : 109-019C Surface treatment : Nickel-chrome plating (silver)
 : 109-019H : Cation electropainting (black)

Color

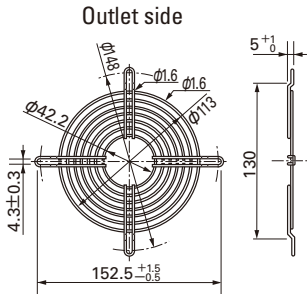

Resin finger guards

Model : 109-1000G

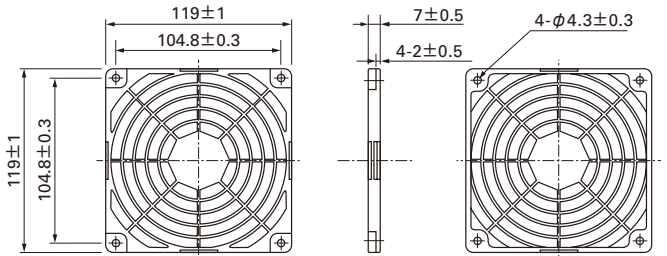

Model : 109-019E Surface treatment : Nickel-chrome plating (silver)
 : 109-019K : Cation electropainting (black)

Color

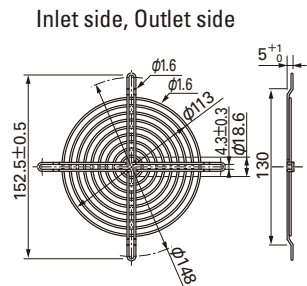

Resin filter kits

Model : 109-1000F13 (13PPI), 109-1000F20 (20PPI)
 : 109-1000F30 (30PPI), 109-1000F40 (40PPI)

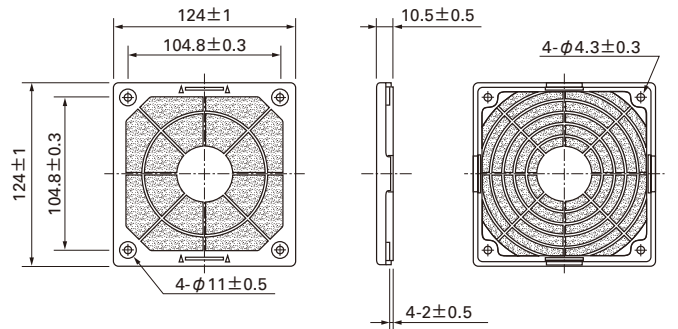

120 mm sq.

San Ace 120

120×120×38mm [Mass : 360g]

Air Flow - Static Pressure Characteristics

PWM Duty Cycle

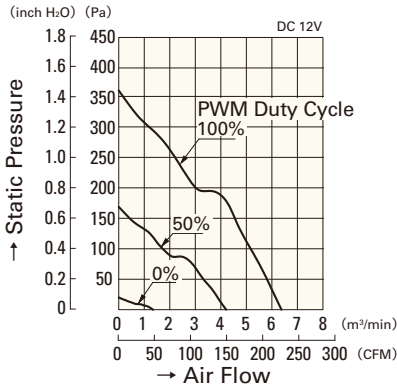

9GV1212P1J01

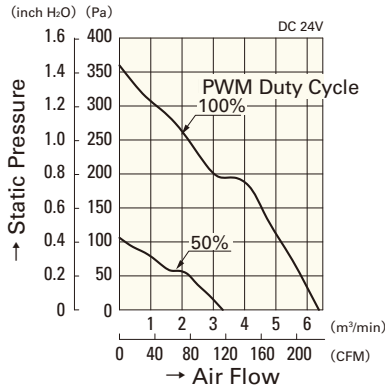

9GV1224P1J01

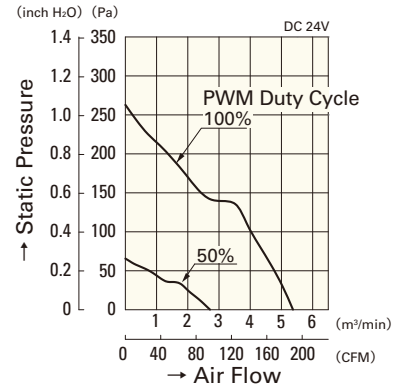

9GV1224P1H01

Operating Voltage Range

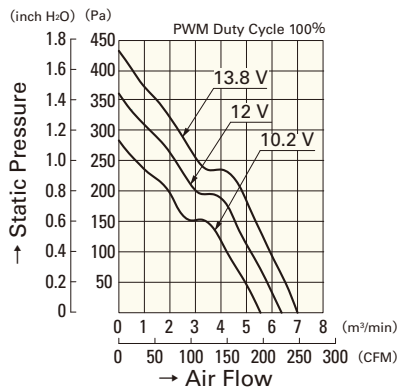

9GV1212P1J01

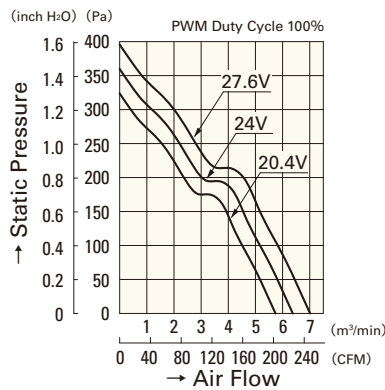

9GV1224P1J01

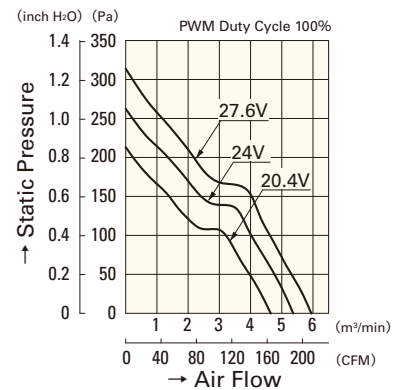

9GV1224P1H01

PWM Duty - Speed Characteristics Example

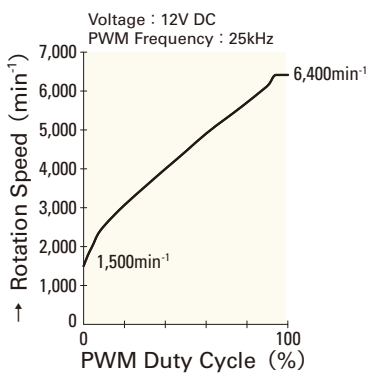

9GV1212P1J01

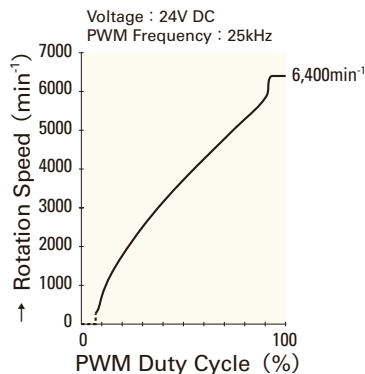

9GV1224P1J01

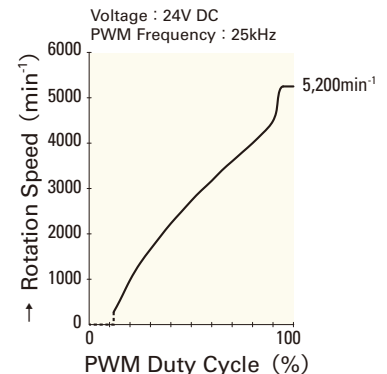

9GV1224P1H01

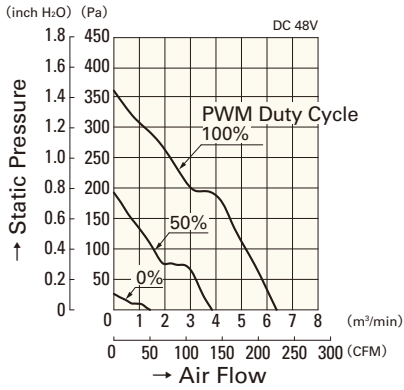

9GV1248P1J01

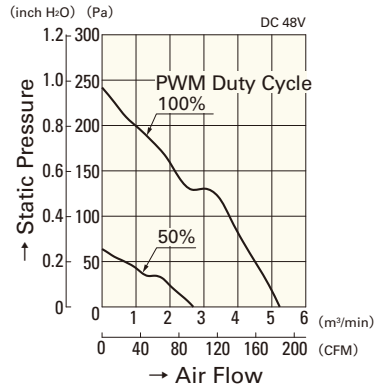

9GV1248P1B10

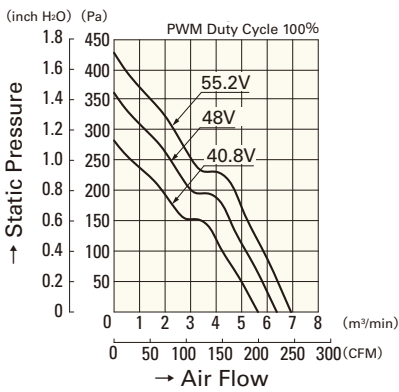

9GV1248P1J01

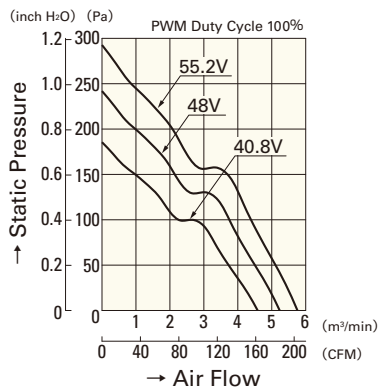

9GV1248P1B10

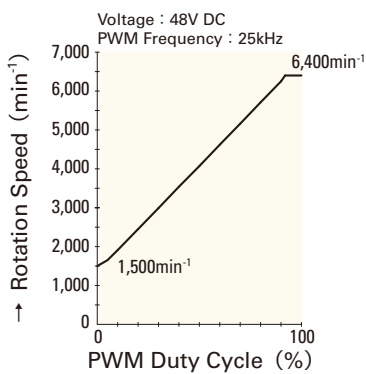

9GV1248P1J01

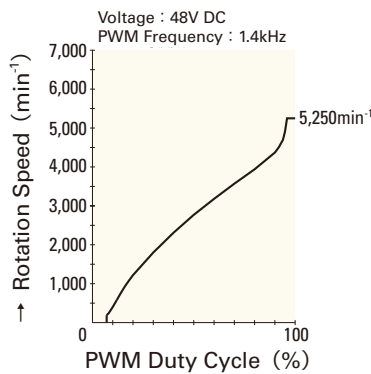

9GV1248P1B10