

Common mode filter with ESD protection for MIPI D-PHY and MDDI interface

Datasheet - production data

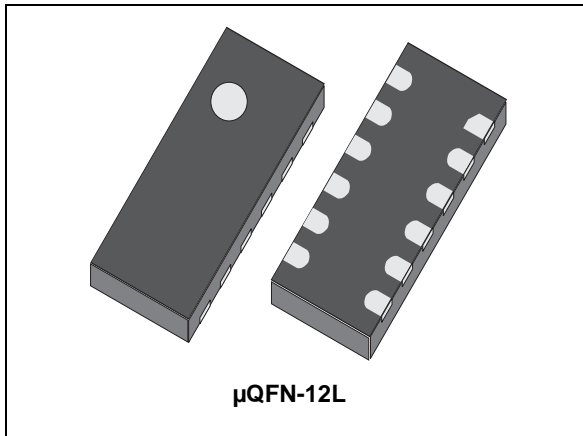
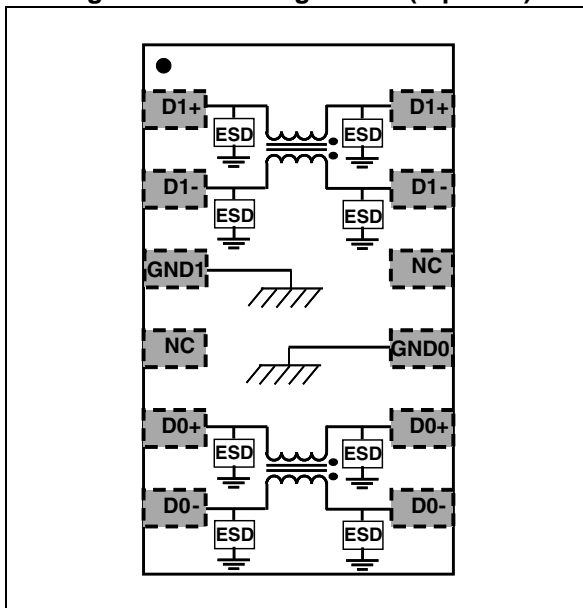

Figure 1. Pin configuration (top view)



Features

- Very large differential bandwidth > 6 GHz
- High common mode attenuation:
 - -34 dB at 900 MHz
 - -20 dB between 800 MHz and 2.2 GHz
- Very low PCB space consumption
- Thin package: 0.6 mm max
- Lead-free package
- High reduction of parasitic elements through integration

Complies with the following standards:

- IEC 61000-4-2 level 4 input and output pins:
 - ±15 kV (air discharge)
 - ±8 kV (contact discharge)

Applications

- Mobile phones
- Notebook, laptop
- Portable devices
- PND

Description

The ECMF04-4AMX12 is a highly integrated common mode filter designed to suppress EMI/RFI common mode noise on high speed differential serial buses like MIPI D-PHY or MDDI.

The ECMF04-4AMX12 can protect and filter 2 lanes.

1 Characteristics

Table 1. Absolute maximum ratings ($T_{amb} = 25\text{ °C}$)

Symbol	Parameter		Value	Unit
V_{PP}	Peak pulse voltage ⁽¹⁾	IEC 61000-4-2 contact discharge IEC 61000-4-2 air discharge	8 20	kV
I_{DC}	Maximum DC current		200	mA
T_{op}	Operating temperature		-40 to +85	°C
T_j	Maximum junction temperature		125	°C
T_{stg}	Storage temperature range		- 55 to +150	°C

1. Measurements done on IEC 61000-4-2 test bench. For further details see Application note AN3353.

Figure 2. Electrical characteristics (definitions)

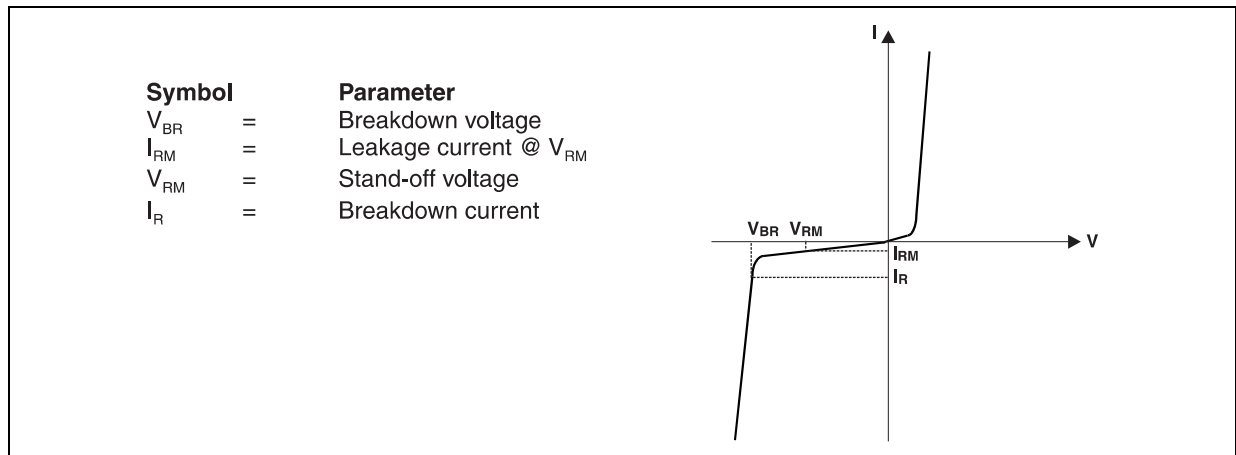

Table 2. Electrical characteristics (values, $T_{amb} = 25\text{ °C}$)

Symbol	Test conditions	Min.	Typ.	Max.	Unit
V_{BR}	$I_R = 1\text{ mA}$	6			V
I_{RM}	$V_{RM} = 1.5\text{ V per line}$			100	nA
R_{DC}	DC serial resistance		1.8	2.5	Ω

Figure 3. S_{dd21} differential attenuation measurements ($Z_{0\text{ diff}} = 100 \Omega$)

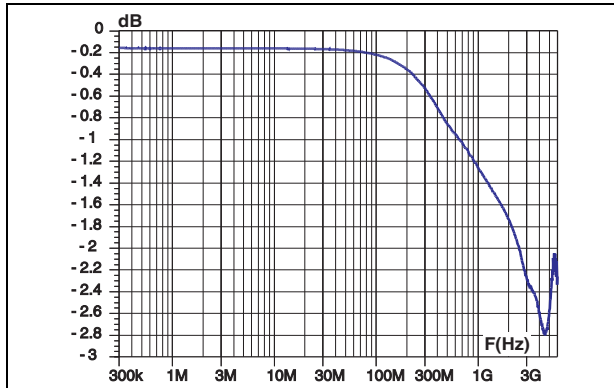

Figure 4. S_{cc21} common mode attenuation measurements ($Z_{0\text{ com}} = 50 \Omega$)

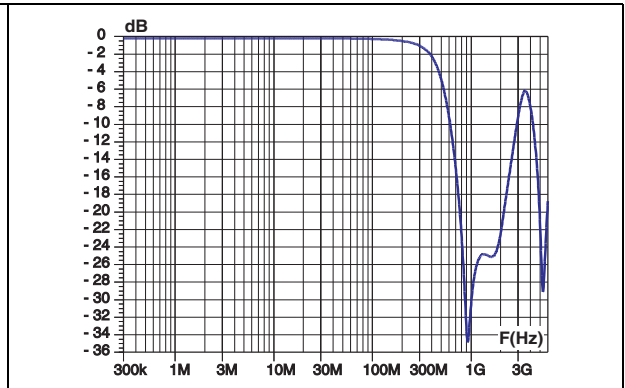

Figure 5. S_{dd11} , S_{dd22} differential return loss measurements ($Z_{0\text{ diff}} = 100 \Omega$)

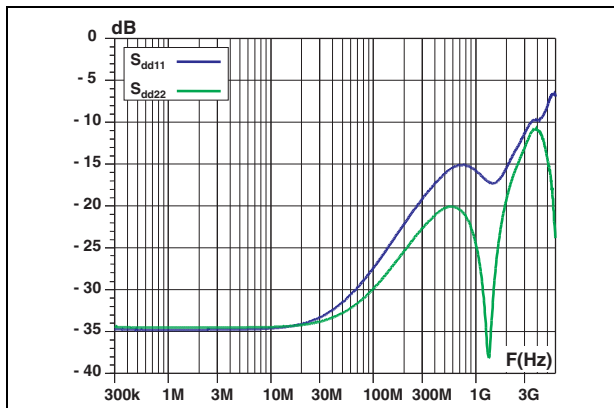

Figure 6. S_{dd41} / S_{dd23} inter-lane differential cross-coupling measurements ($Z_{0\text{ diff}} = 100 \Omega$)

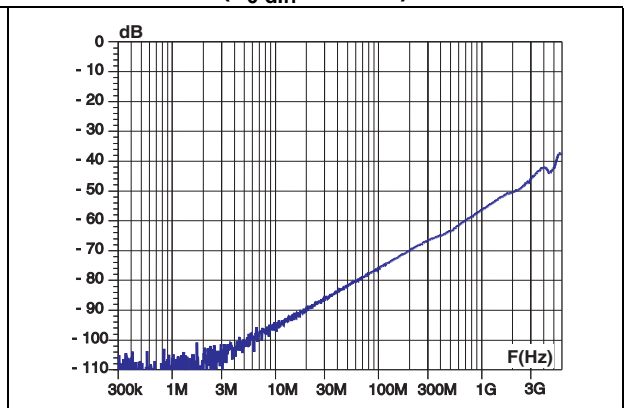

Figure 7. S_{cc41} / S_{cc23} inter-lane common-mode cross-coupling measurements ($Z_{0\text{ com}} = 50 \Omega$)

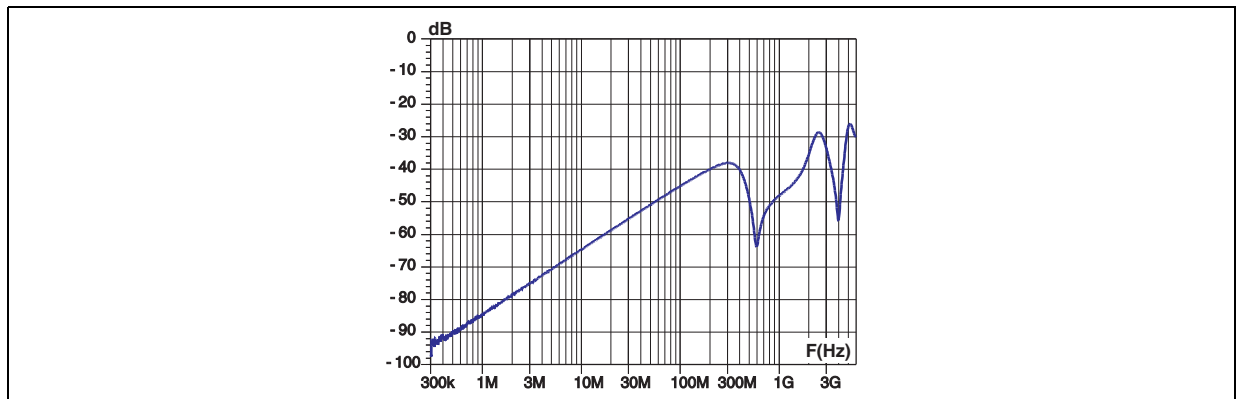

Figure 8. ESD response to IEC 61000-4-2 (+8kV contact discharge)

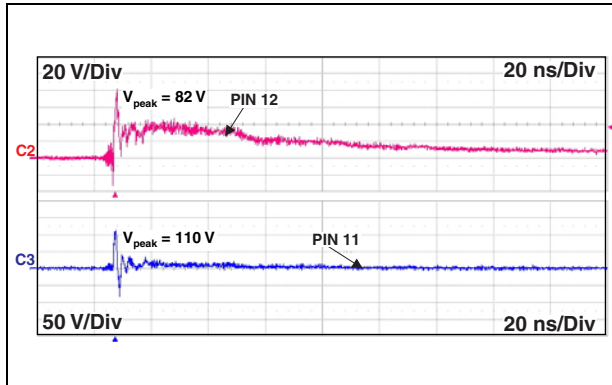

Figure 9. ESD response to IEC 61000-4-2 (-8kV contact discharge)

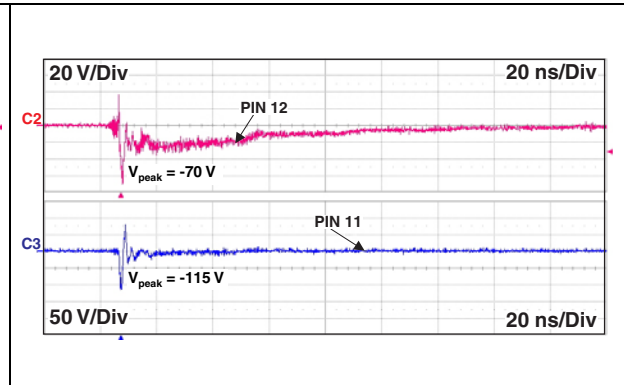

Figure 10. MIPI D-PHY low power mode test setup

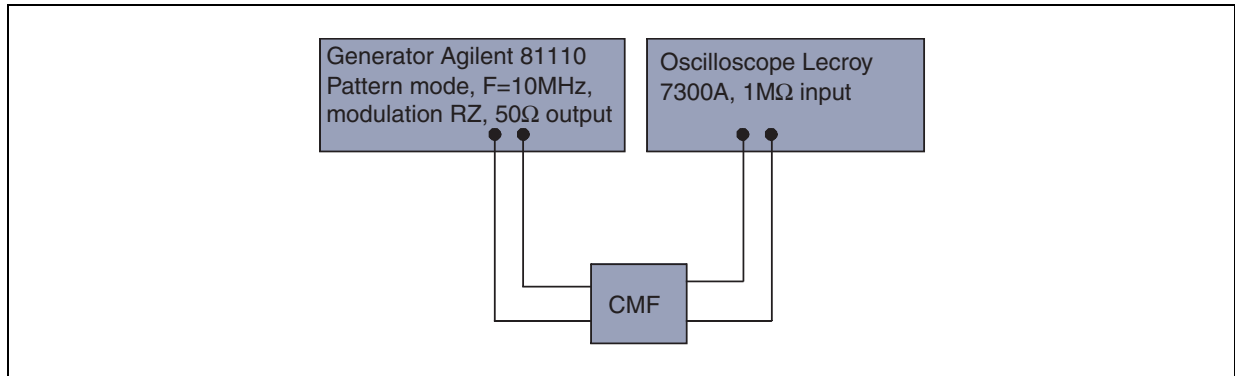
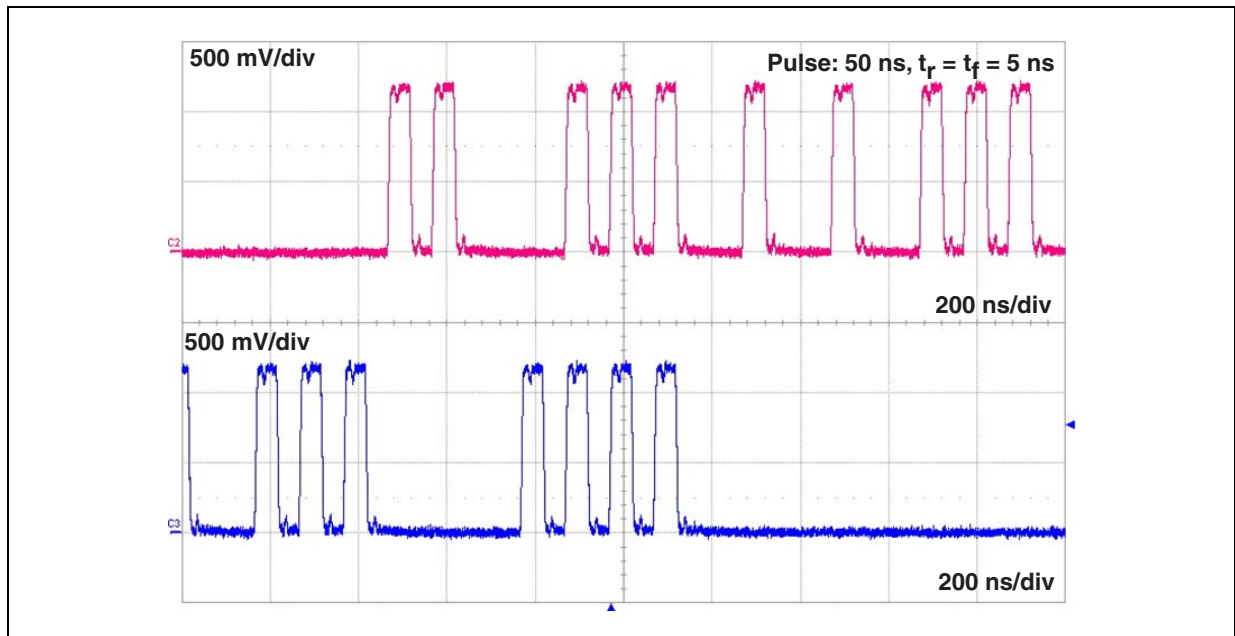
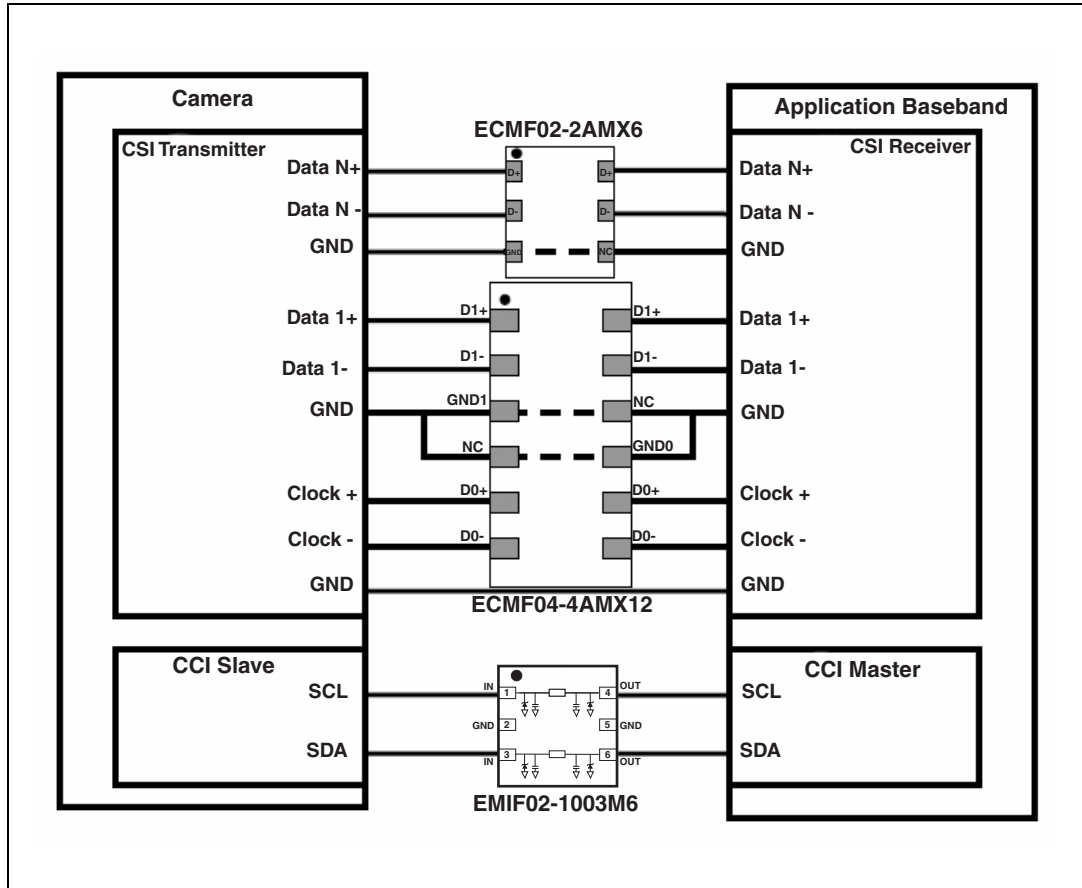

Figure 11. Low power pulse response - see [Figure 10](#) for test setup



2 Application information

Figure 12. Application information



3 Ordering information scheme

Figure 13. Ordering information scheme

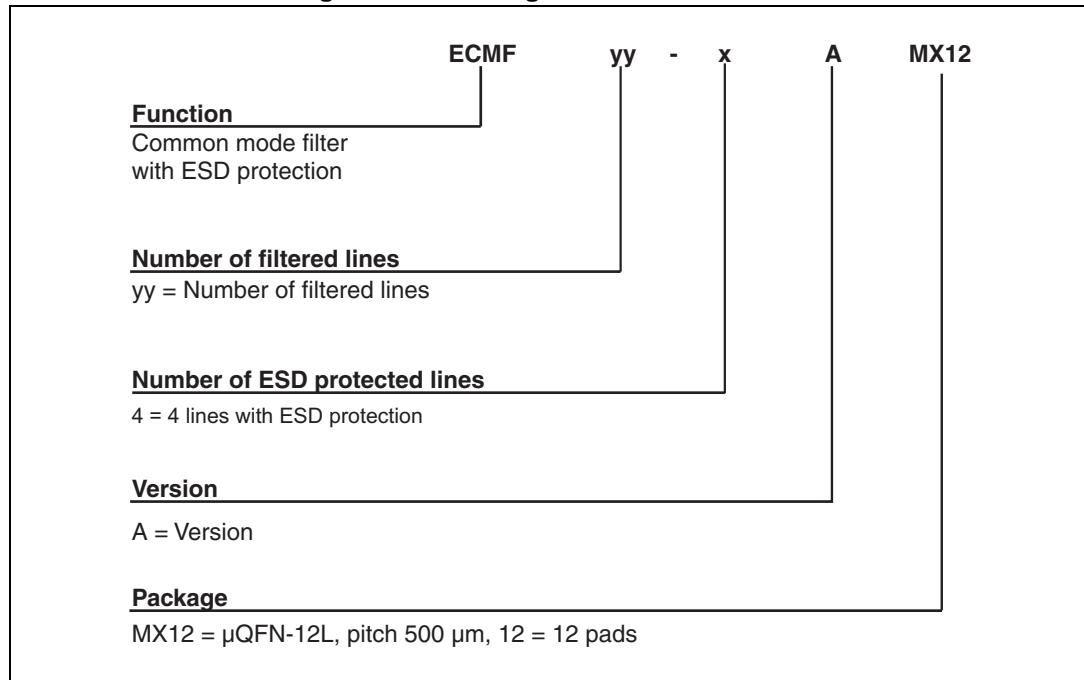

4 Package information

- Epoxy meets UL94, V0
- Lead-free packages

In order to meet environmental requirements, ST offers these devices in different grades of ECOPACK® packages, depending on their level of environmental compliance. ECOPACK® specifications, grade definitions and product status are available at: www.st.com. ECOPACK® is an ST trademark.

Table 3. μQFN-12L dimensions

Ref.	Dimensions					
	Millimeters			Inches		
	Min.	Typ.	Max.	Min.	Typ.	Max.
A	0.51	0.55	0.6	0.020	0.022	0.024
A1	0	0.02	0.05	0.000	0.001	0.002
b	0.18	0.25	0.3	0.007	0.010	0.012
D	3.25	3.3	3.35	0.128	0.130	0.132
E	1.45	1.5	1.55	0.057	0.059	0.061
e	0.45	0.5	0.55	0.018	0.020	0.022
L	0.3	0.4	0.5	0.012	0.016	0.020

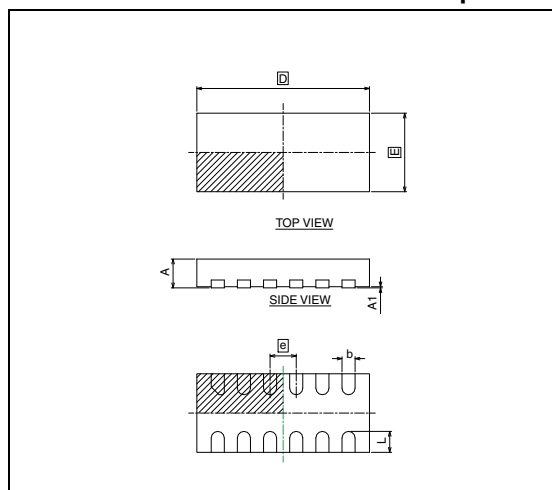
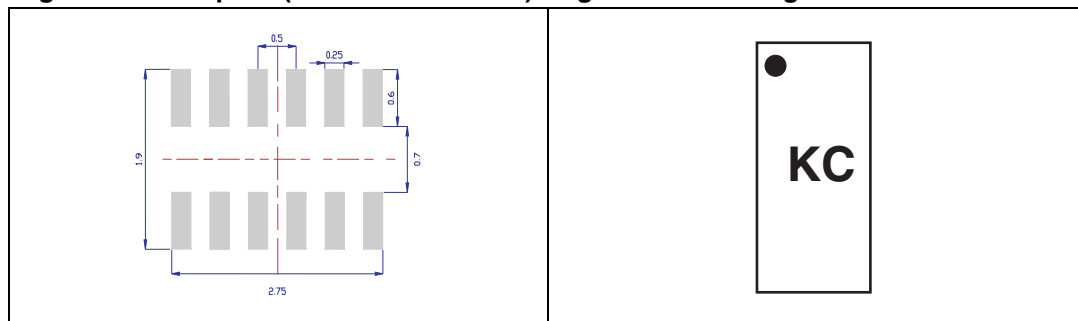
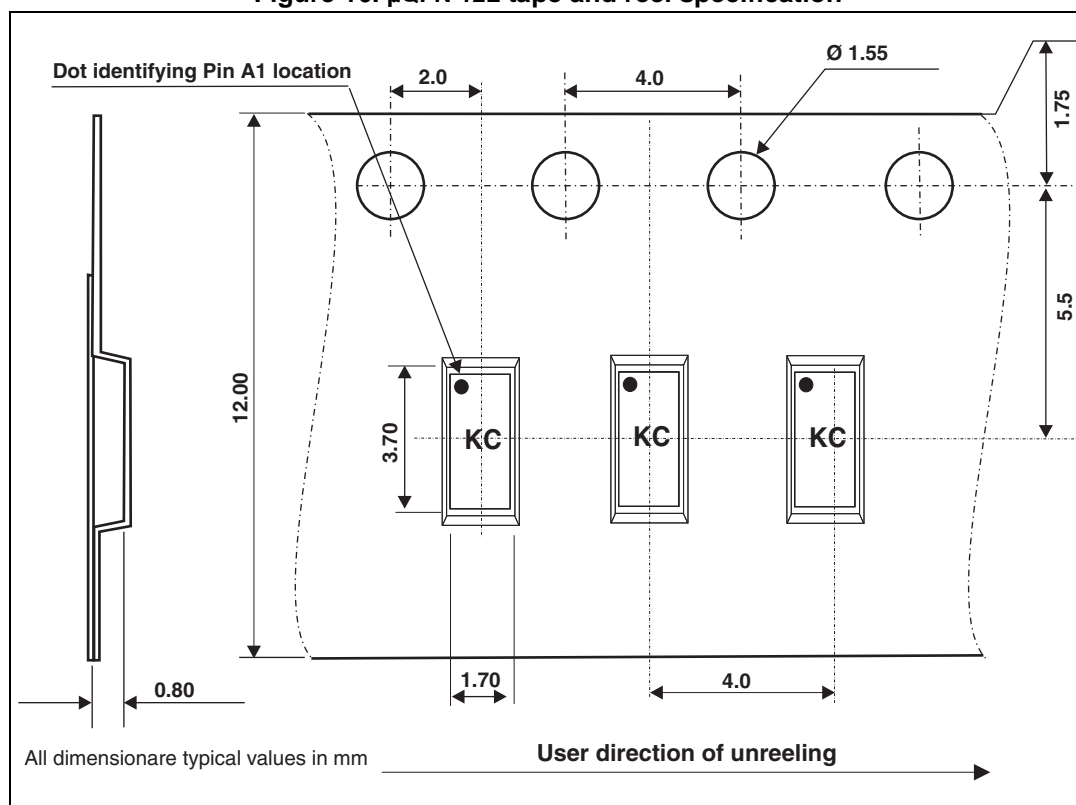

Figure 14. Footprint (dimensions in mm) Figure 15. Marking



Note: Product marking may be rotated by 90° for assembly plant differentiation. In no case should this product marking be used to orient the component for its placement on a PCB. Only pin 1 mark is to be used for this purpose.

Figure 16. μ QFN-12L tape and reel specification



5 Recommendation on PCB assembly

5.1 Stencil opening design

1. General recommendation on stencil opening design
 - a) Stencil opening dimensions: L (Length), W (Width), T (Thickness).

Figure 17. Stencil opening dimensions

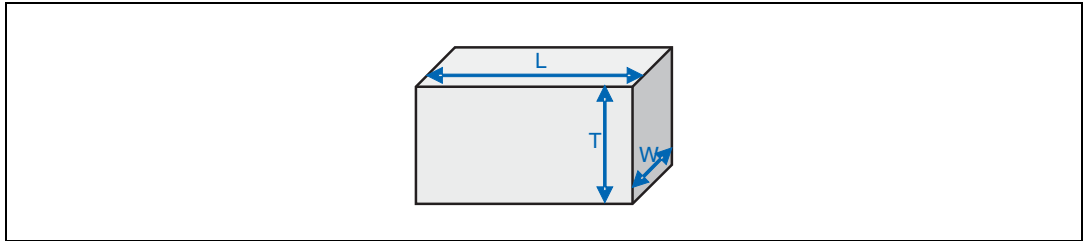

- b) General design rule
 - Stencil thickness (T) = 75 ~ 125 μm
 - Aspect ratio = $\frac{W}{T} \geq 1.5$
 - Aspect area = $\frac{L \times W}{2T(L + W)} \geq 0.66$

2. Reference design
 - a) Stencil opening thickness: 100 μm
 - b) Stencil opening for leads: Opening to footprint ratio is 90%.

Figure 18. Recommended stencil window position

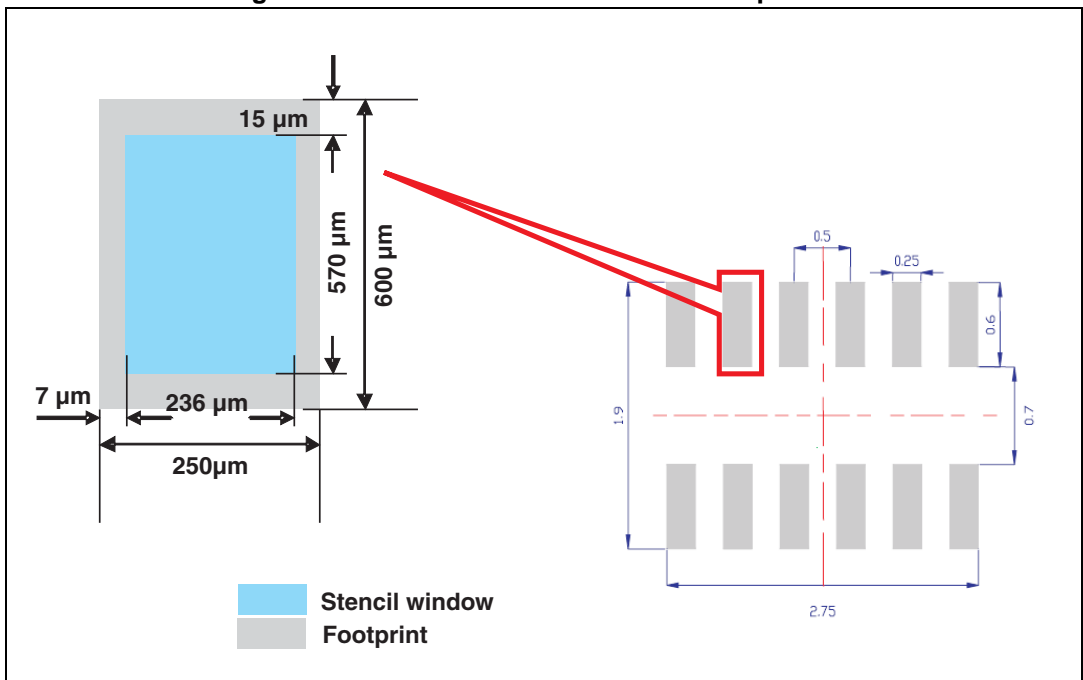

5.2 Solder paste

1. Use halide-free flux, qualification ROL0 according to ANSI/J-STD-004.
2. “No clean” solder paste recommended.
3. Offers a high tack force to resist component displacement during PCB movement.
4. Use solder paste with fine particles: powder particle size 20-45 μm .

5.3 Placement

1. Manual positioning is not recommended.
2. It is recommended to use the lead recognition capabilities of the placement system, not the outline centering.
3. Standard tolerance of ± 0.05 mm is recommended.
4. 3.5 N placement force is recommended. Too much placement force can lead to squeezed out solder paste and cause solder joints to short. Too low placement force can lead to insufficient contact between package and solder paste that could cause open solder joints or badly centered packages.
5. To improve the package placement accuracy, a bottom side optical control should be performed with a high resolution tool.
6. For assembly, a perfect supporting of the PCB (all the more on flexible PCB) is recommended during solder paste printing, pick and place and reflow soldering by using optimized tools.

5.4 PCB design preference

1. To control the solder paste amount, the closed via is recommended instead of open vias.
2. The position of tracks and open vias in the solder area should be well balanced. The symmetrical layout is recommended, in case any tilt phenomena caused by asymmetrical solder paste amount due to the solder flow away.

5.5 Reflow profile

Figure 19. ST ECOPACK® recommended soldering reflow profile for PCB mounting

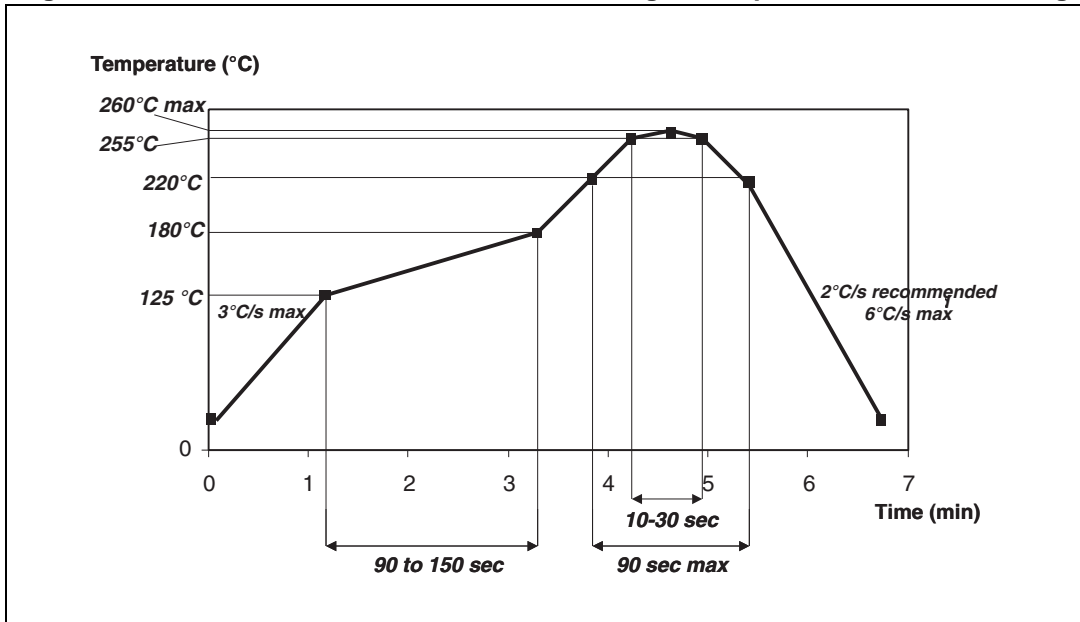

Note: Minimize air convection currents in the reflow oven to avoid component movement.

5.6 Layout recommendation

Connection to PCB GND must be as short as possible to ensure ESD remaining voltage and S_{CC21} performance.

Figure 20. Layout recommendation

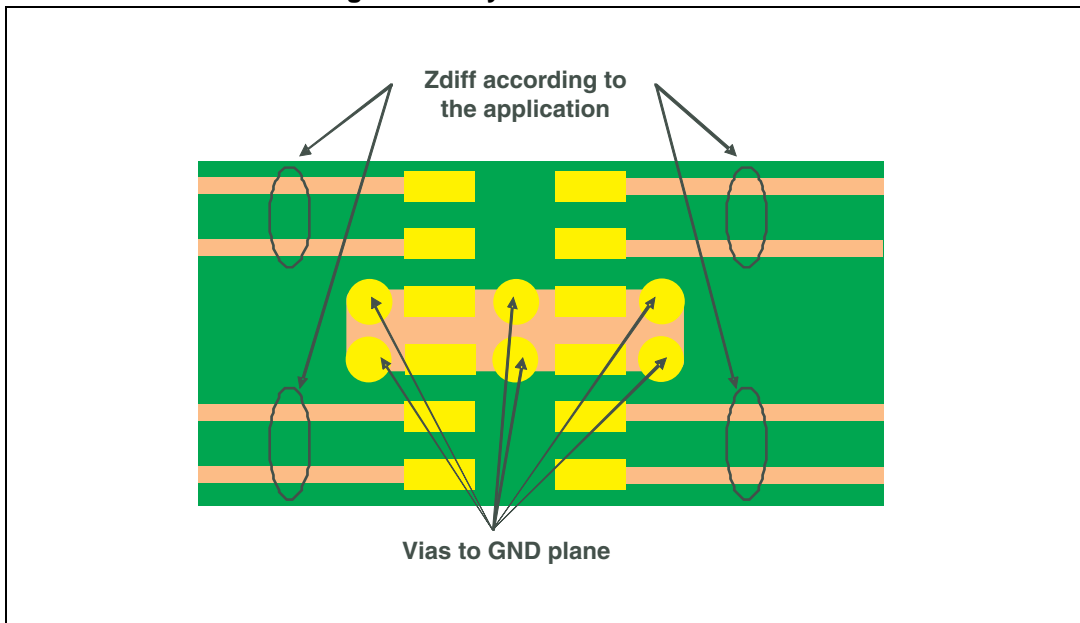

6 Ordering information

Table 4. Ordering information

Order code	Marking	Package	Weight	Base qty	Delivery mode
ECMF04-4AMX12	KC ⁽¹⁾	μQFN-12L	7.25 mg	3000	Tape and reel 7"

1. The marking can be rotated by 90° to differentiate assembly location

For the latest information on available order codes see the product pages on www.st.com.

7 Revision history

Table 5. Document revision history

Date	Revision	Changes
10-Aug-2010	1	Initial release.
28-Jun-2011	2	Added Complies with the following standards: and Air discharge parameter in Table 1 .
14-Mar-2014	3	Corrected typographical error in Description .

Please Read Carefully:

Information in this document is provided solely in connection with ST products. STMicroelectronics NV and its subsidiaries ("ST") reserve the right to make changes, corrections, modifications or improvements, to this document, and the products and services described herein at any time, without notice.

All ST products are sold pursuant to ST's terms and conditions of sale.

Purchasers are solely responsible for the choice, selection and use of the ST products and services described herein, and ST assumes no liability whatsoever relating to the choice, selection or use of the ST products and services described herein.

No license, express or implied, by estoppel or otherwise, to any intellectual property rights is granted under this document. If any part of this document refers to any third party products or services it shall not be deemed a license grant by ST for the use of such third party products or services, or any intellectual property contained therein or considered as a warranty covering the use in any manner whatsoever of such third party products or services or any intellectual property contained therein.

UNLESS OTHERWISE SET FORTH IN ST'S TERMS AND CONDITIONS OF SALE ST DISCLAIMS ANY EXPRESS OR IMPLIED WARRANTY WITH RESPECT TO THE USE AND/OR SALE OF ST PRODUCTS INCLUDING WITHOUT LIMITATION IMPLIED WARRANTIES OF MERCHANTABILITY, FITNESS FOR A PARTICULAR PURPOSE (AND THEIR EQUIVALENTS UNDER THE LAWS OF ANY JURISDICTION), OR INFRINGEMENT OF ANY PATENT, COPYRIGHT OR OTHER INTELLECTUAL PROPERTY RIGHT.

ST PRODUCTS ARE NOT DESIGNED OR AUTHORIZED FOR USE IN: (A) SAFETY CRITICAL APPLICATIONS SUCH AS LIFE SUPPORTING, ACTIVE IMPLANTED DEVICES OR SYSTEMS WITH PRODUCT FUNCTIONAL SAFETY REQUIREMENTS; (B) AERONAUTIC APPLICATIONS; (C) AUTOMOTIVE APPLICATIONS OR ENVIRONMENTS, AND/OR (D) AEROSPACE APPLICATIONS OR ENVIRONMENTS. WHERE ST PRODUCTS ARE NOT DESIGNED FOR SUCH USE, THE PURCHASER SHALL USE PRODUCTS AT PURCHASER'S SOLE RISK, EVEN IF ST HAS BEEN INFORMED IN WRITING OF SUCH USAGE, UNLESS A PRODUCT IS EXPRESSLY DESIGNATED BY ST AS BEING INTENDED FOR "AUTOMOTIVE, AUTOMOTIVE SAFETY OR MEDICAL" INDUSTRY DOMAINS ACCORDING TO ST PRODUCT DESIGN SPECIFICATIONS. PRODUCTS FORMALLY ESCC, QML OR JAN QUALIFIED ARE DEEMED SUITABLE FOR USE IN AEROSPACE BY THE CORRESPONDING GOVERNMENTAL AGENCY.

Resale of ST products with provisions different from the statements and/or technical features set forth in this document shall immediately void any warranty granted by ST for the ST product or service described herein and shall not create or extend in any manner whatsoever, any liability of ST.

ST and the ST logo are trademarks or registered trademarks of ST in various countries.

Information in this document supersedes and replaces all information previously supplied.

The ST logo is a registered trademark of STMicroelectronics. All other names are the property of their respective owners.

© 2014 STMicroelectronics - All rights reserved

STMicroelectronics group of companies

Australia - Belgium - Brazil - Canada - China - Czech Republic - Finland - France - Germany - Hong Kong - India - Israel - Italy - Japan - Malaysia - Malta - Morocco - Philippines - Singapore - Spain - Sweden - Switzerland - United Kingdom - United States of America

www.st.com

