

**DATA SHEET**

# SKY65120: 2110–2170 MHz High Linearity 2 W Power Amplifier

**Applications**

- WCDMA/PCS/DCS/UMTS/TD-SCDMA
- Repeaters
- ISM band transmitter
- WCS fixed wireless

**Features**

- High linearity: OIP3 > 48 dBm
- $OP_{1\text{ dB}} > 33.5\text{ dBm}$
- $ACLR = -45\text{ dBc}$  for  $P_{OUT} > +25.4\text{ dBm}$
- High efficiency: PAE 42%
- High gain: 24.6 dB
- Internal RF match and bias circuits
- Single DC supply: 5 V
- Low cost 6 x 6 mm SMT package
- Available lead (Pb)-free and RoHS-compliant

**Description**

The SKY65120 is a fully matched 20-pin, lead-free, surface mount, Multi-Chip Module (MCM) Power Amplifier (PA) designed for WCDMA/PCS/DCS/UTMS/TD-SCDMA Radio, repeaters, transmitters, and WCS fixed wireless units operating in the 2110–2170 MHz bandwidth.

All active circuitry in the module is contained in a single Gallium Arsenide (GaAs) Microwave Monolithic Integrated Circuit (MMIC).

The device is manufactured with Skyworks Aluminum (Al) GaAs Heterojunction Bipolar Transistor (HBT) process, which allows for single supply operation while maintaining high efficiency and good linearity.

The module can operate over the temperature range of  $-40^{\circ}\text{C}$  to  $+85^{\circ}\text{C}$ . A populated evaluation board is available upon request.

**NEW**

Skyworks offers lead (Pb)-free, RoHS (Restriction of Hazardous Substances)-compliant packaging.



**Functional Block Diagram**

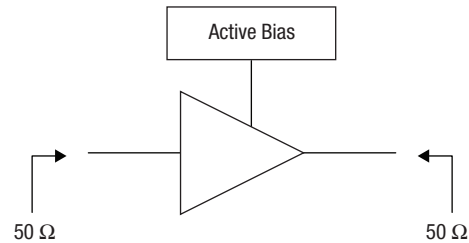

**Block Diagram**

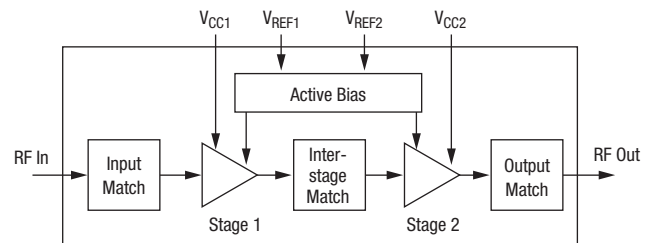

**Package Diagram**

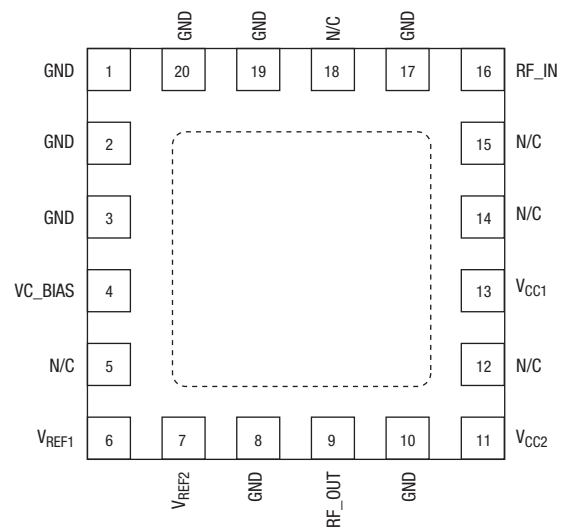

### Electrical Specifications

**V<sub>CC1</sub>, V<sub>CC2</sub>, V<sub>REF1</sub>, V<sub>REF2</sub>, V<sub>C\_BIAS</sub> = 5 V, Frequency = 2140 MHz, T<sub>c</sub> = 25 °C, unless otherwise specified.**

Parameter	Symbol	Condition	Min.	Typ.	Max.	Unit
Gain	S <sub>21</sub>	Small signal	23	24.6		dB
Input return loss	S <sub>11</sub>	Small signal	10	16.8		dB
Output power @ P <sub>1</sub> dB	P <sub>1</sub> dB	CW	32.5	33.5		dBm
Output 3rd order intercept	OIP3	P <sub>OUT</sub> /tone = 24 dBm	44	48		dBm
Noise figure	NF	CW		8.4	9	dB
P <sub>OUT</sub> at ALCR = -45 dBc	P <sub>OUT_ACLR</sub>	WCDMA test tone #1: 64 DPCH	25	25.4		dBm
PAE at ALCR = -45 dBc	PAE_ACLR	WCDMA test tone #1: 64 DPCH		12		%
Quiescent current	I <sub>CCQ</sub>	No RF signal	420	447	470	mA
Power added efficiency	PAE	CW, P <sub>OUT</sub> @ P <sub>1</sub> dB	33	42		%
Thermal resistance	Θ <sub>JC</sub>	Junction to case		24		°C/W

### Absolute Maximum Ratings

Characteristic	Value
RF input power	5 dBm
Supply voltage (V <sub>CC</sub> )	5.5 V
Supply current (I <sub>CC</sub> )	1100 mA
Operating temperature	-40 °C to +85 °C
Storage temperature	-55 °C to +125 °C

Performance is guaranteed only under the conditions listed in the specifications table and is not guaranteed under the full range(s) described by the Absolute Maximum specifications. Exceeding any of the absolute maximum/minimum specifications may result in permanent damage to the device and will void the warranty. Each absolute maximum rating listed is an individual parameter. Biasing and driving the amplifier with more than one absolute maximum rating listed may result in permanent damage to the device. Exposure to maximum rating conditions for extended periods may reduce device reliability.

**CAUTION:** *Although this device is designed to be as robust as possible, Electrostatic Discharge (ESD) can damage this device. This device must be protected at all times from ESD. Static charges may easily produce potentials of several kilovolts on the human body or equipment, which can discharge without detection. Industry-standard ESD precautions should be employed at all times.*

### Recommended Operating Conditions

Parameter	Symbol	Conditions	Min.	Typ.	Max.	Unit
Supply voltage	V <sub>CC</sub> , V <sub>REF</sub> , V <sub>C_BIAS</sub>			5	5.5	V
Operating frequency	F <sub>0</sub>		2110		2170	MHz
Operating temperature	T <sub>C</sub>		-40	+25	+85	°C

### Typical Performance Data

$V_{CC1}$ ,  $V_{CC2}$ ,  $V_{REF1}$ ,  $V_{REF2}$ ,  $V_{C\_BIAS}$  = 5 V, Frequency = 2140 MHz,  $T_c$  = 25 °C, unless otherwise specified.

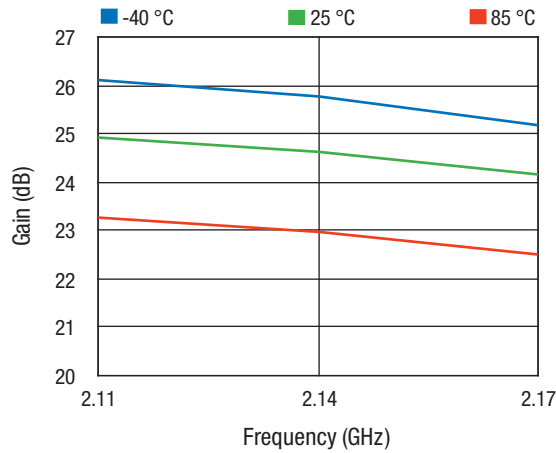

Gain vs. Frequency Across Temperature

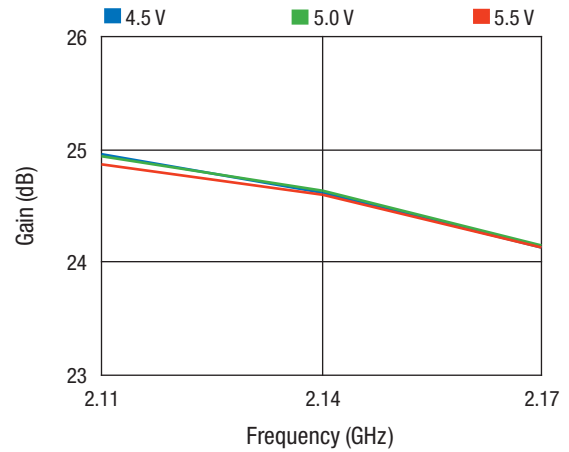

Gain vs. Frequency Across Voltage

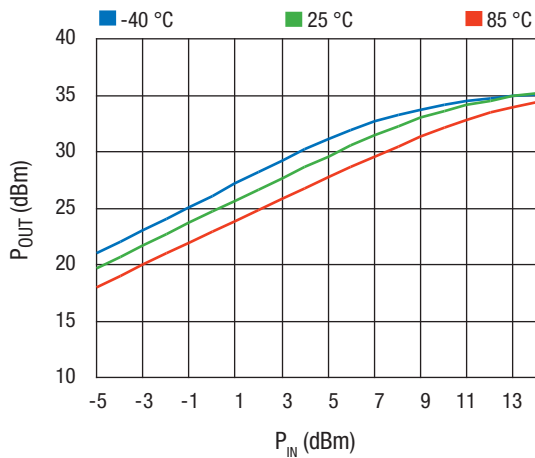

$P_{OUT}$  vs.  $P_{IN}$  Across Temperature

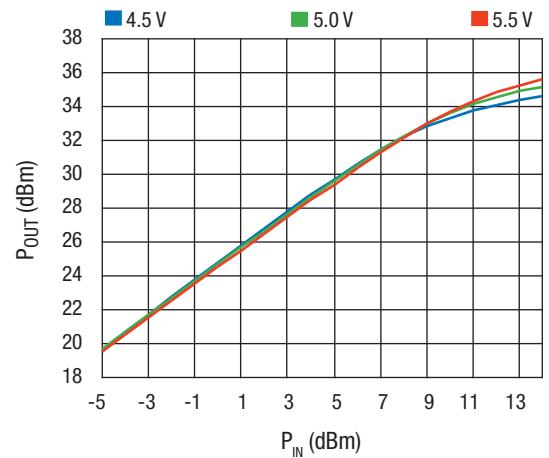

$P_{OUT}$  vs.  $P_{IN}$  Across Voltage

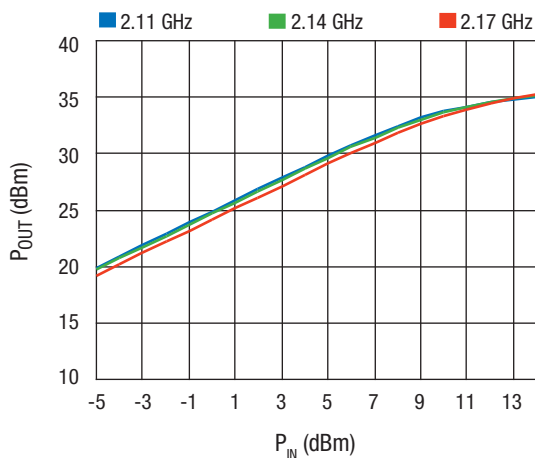

$P_{OUT}$  vs.  $P_{IN}$  Across Frequency

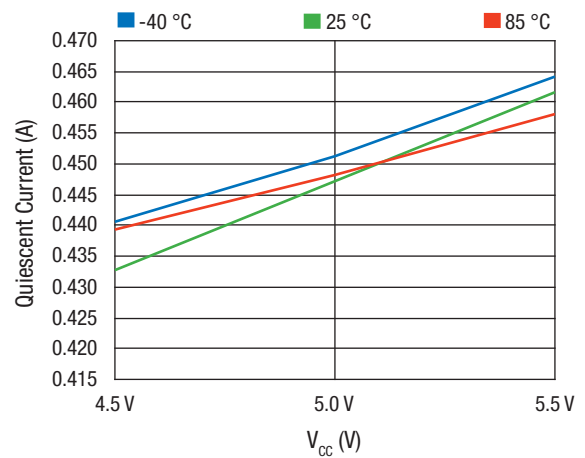

Quiescent Current vs. Voltage Across Temperature

### Typical Performance Data

$V_{CC1}, V_{CC2}, V_{REF1}, V_{REF2}, V_{C\_BIAS} = 5\text{ V}$ , Frequency = 2140 MHz,  $T_c = 25\text{ }^\circ\text{C}$ , unless otherwise specified.

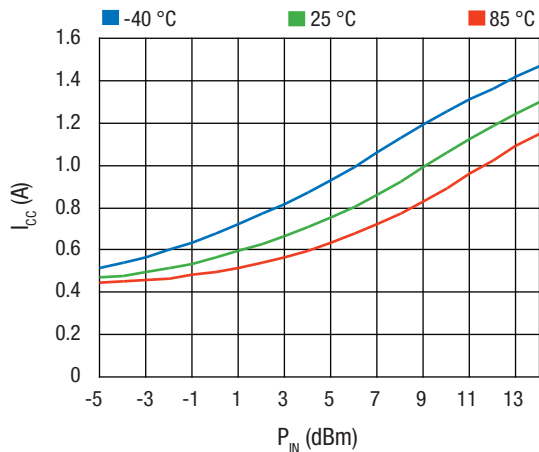

**$I_{CC}$  vs.  $P_{IN}$  Across Temperature**

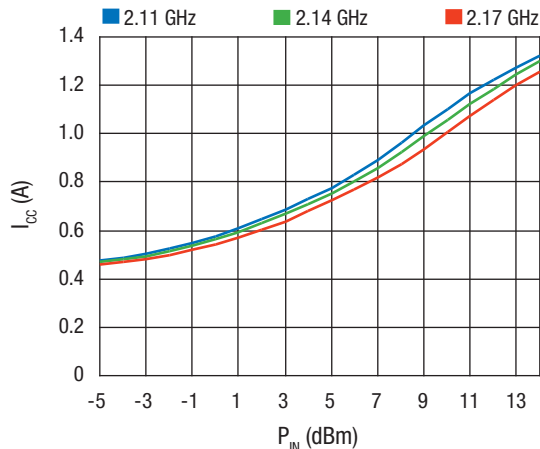

**$I_{CC}$  vs.  $P_{IN}$  Across Frequency**

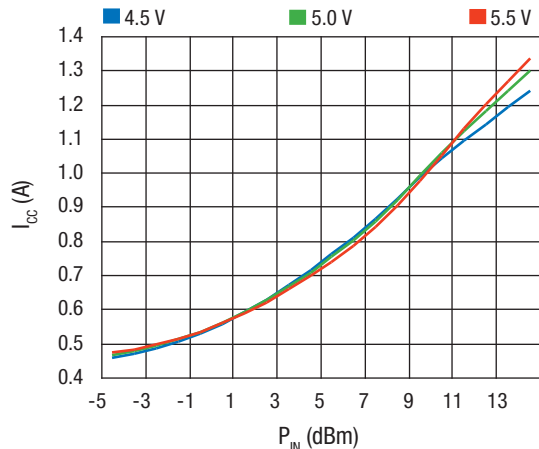

**$I_{CC}$  vs.  $P_{IN}$  Across  $V_{CC}$**

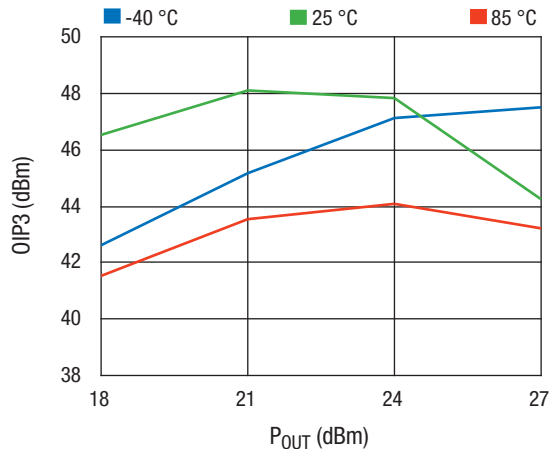

**$OIP3$  vs.  $P_{OUT}$  Across Temperature**

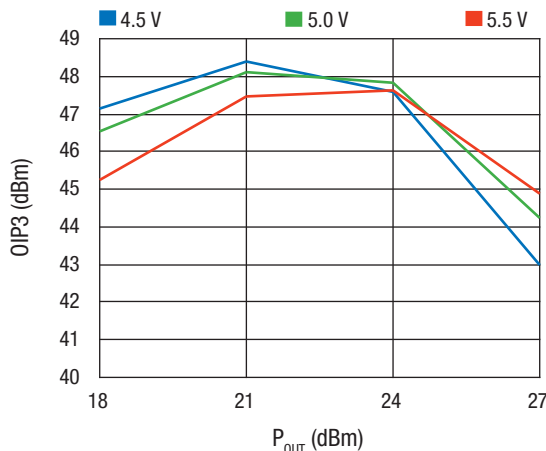

**$OIP3$  vs.  $P_{OUT}$  Across Voltage**

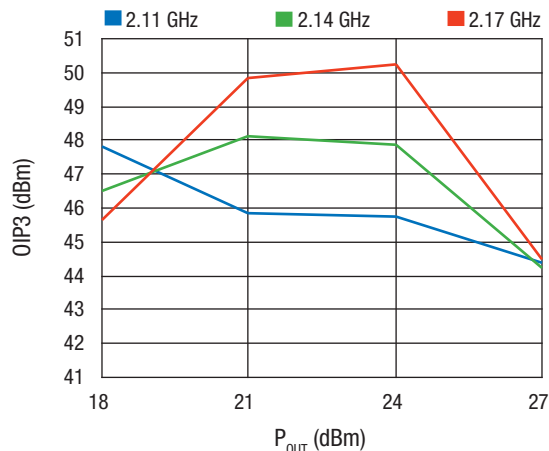

**$OIP3$  vs.  $P_{OUT}$  Across Frequency**

### Typical Performance Data

$V_{CC1}, V_{CC2}, V_{REF1}, V_{REF2}, V_{C\_BIAS} = 5\text{ V}$ , Frequency = 2140 MHz,  $T_c = 25\text{ }^\circ\text{C}$ , unless otherwise specified.

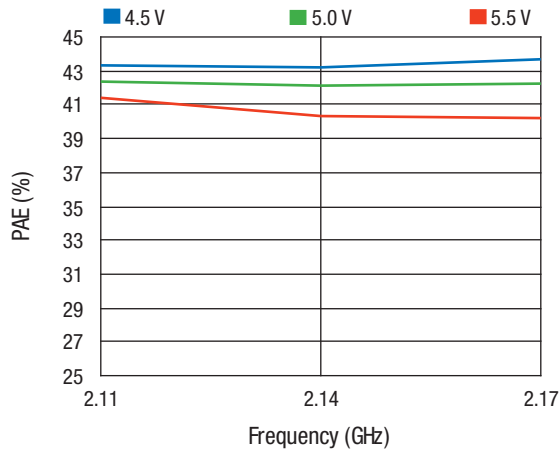

PAE vs. Frequency Across Voltage

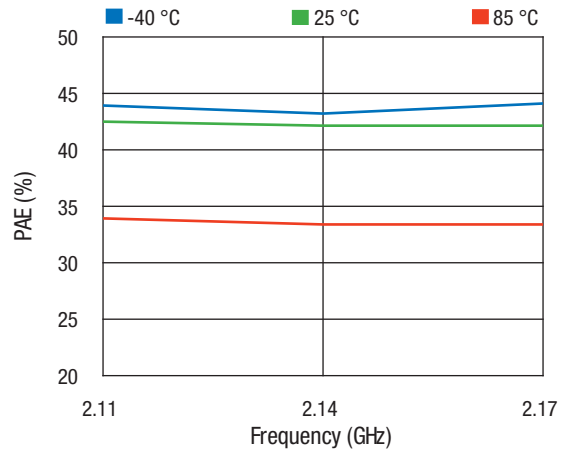

PAE vs. Frequency Across Temperature

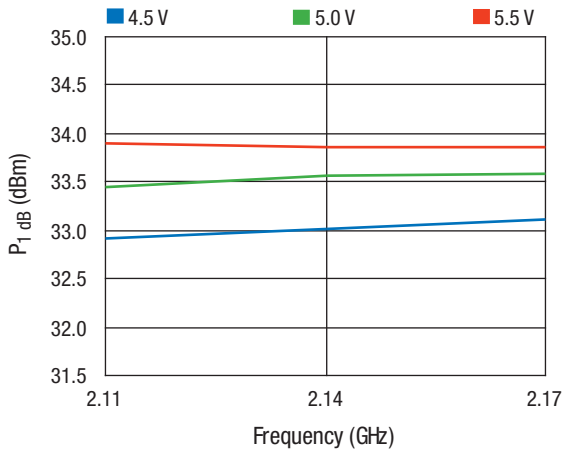

P<sub>1</sub> dB vs. Frequency Across Voltage

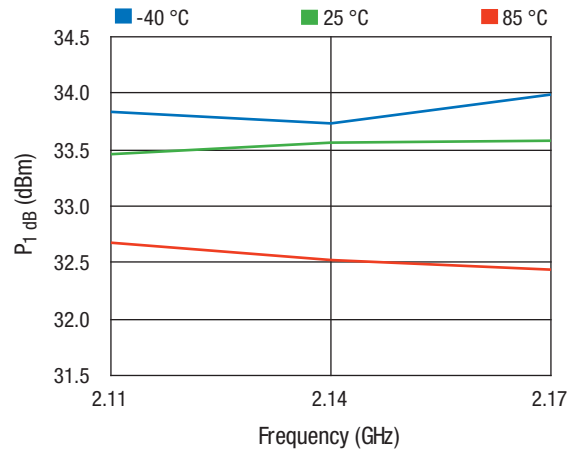

P<sub>1</sub> dB vs. Frequency Across Temperature

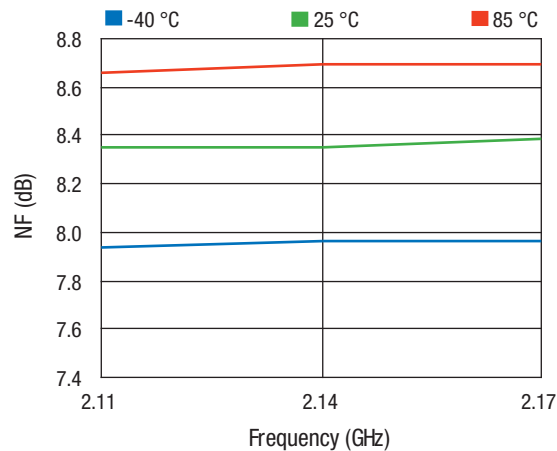

NF vs. Frequency Across Temperature

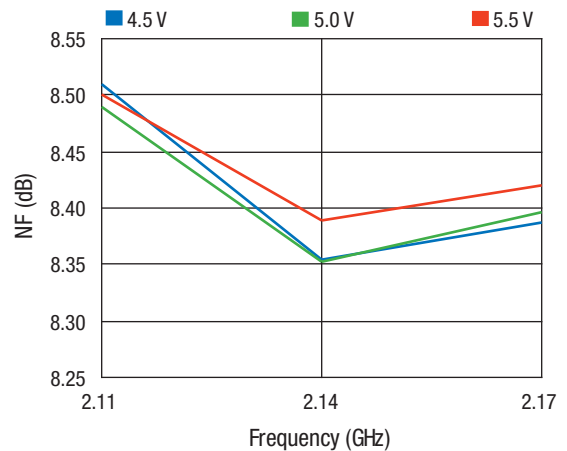

NF vs. Frequency Across Voltage

### Typical Performance Data

$V_{CC1}, V_{CC2}, V_{REF1}, V_{REF2}, V_{C\_BIAS} = 5\text{ V}$ , Frequency = 2140 MHz,  $T_c = 25\text{ }^\circ\text{C}$ , unless otherwise specified.

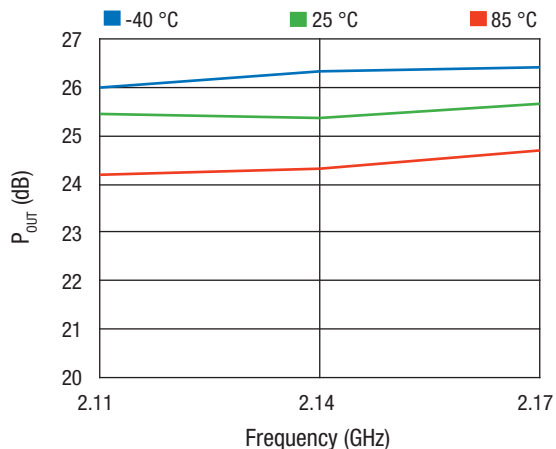

$P_{OUT}$  @ ACLR = -45 dBc vs. Freq. Across Temp.

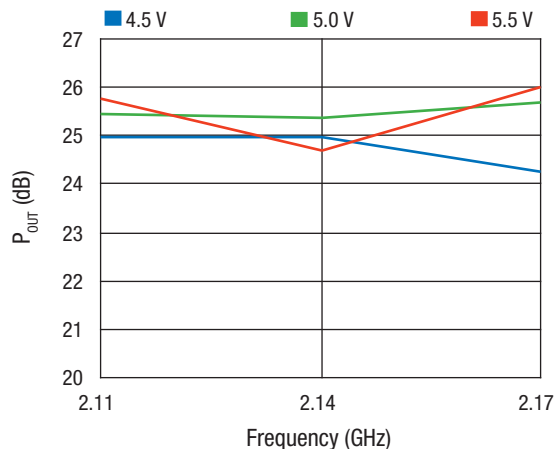

$P_{OUT}$  @ ACLR = -45 dBc vs. Freq. Across Voltage

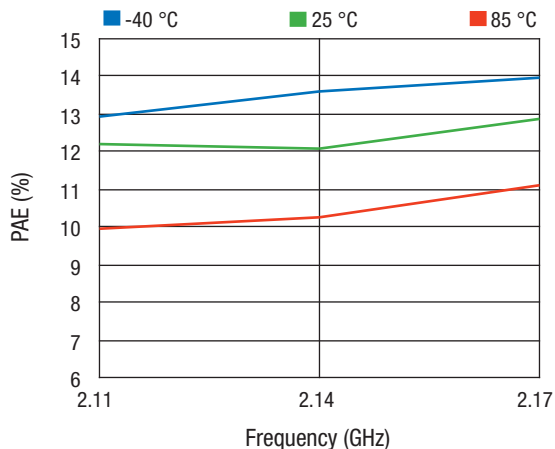

PAE @ ACLR = -45 dBc vs. Freq. Across Temp.

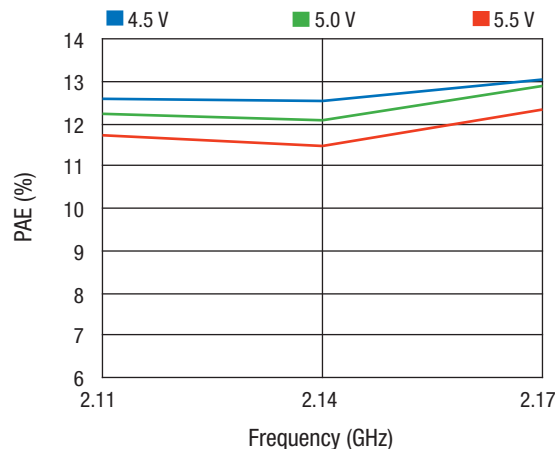

PAE @ ACLR = -45 dBc vs. Freq. Across Voltage

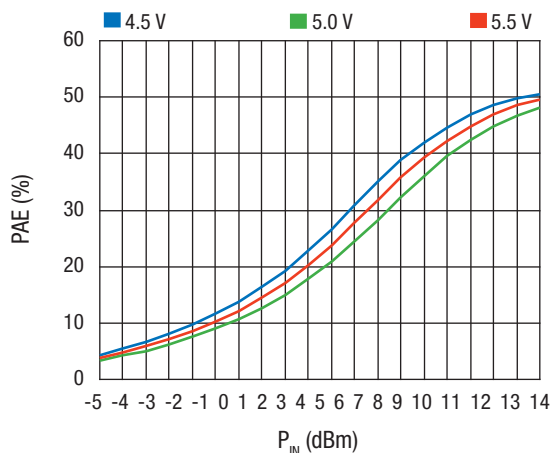

PAE vs.  $P_{IN}$  Across  $V_{CC}$

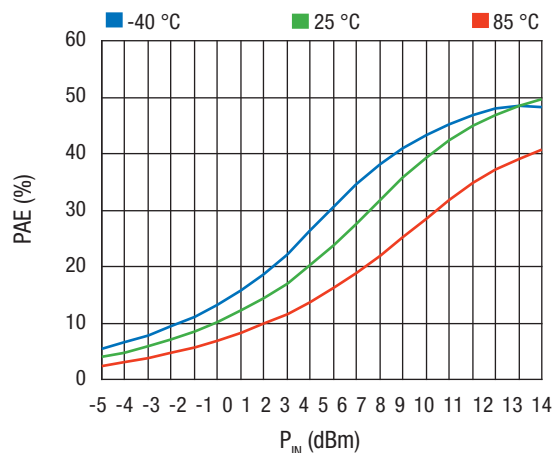

PAE vs.  $P_{IN}$  Across Temperature

## Typical Performance Data

$V_{CC1}$ ,  $V_{CC2}$ ,  $V_{REF1}$ ,  $V_{REF2}$ ,  $V_{C\_BIAS} = 5\text{ V}$ , Frequency = 2140 MHz,  $T_c = 25\text{ }^\circ\text{C}$ , unless otherwise specified.

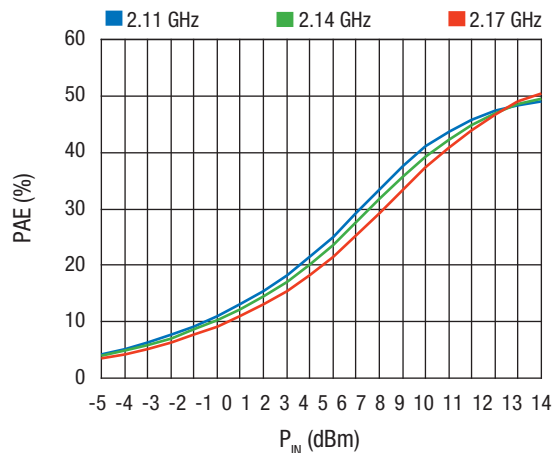

PAE vs.  $P_{IN}$  Across Frequency

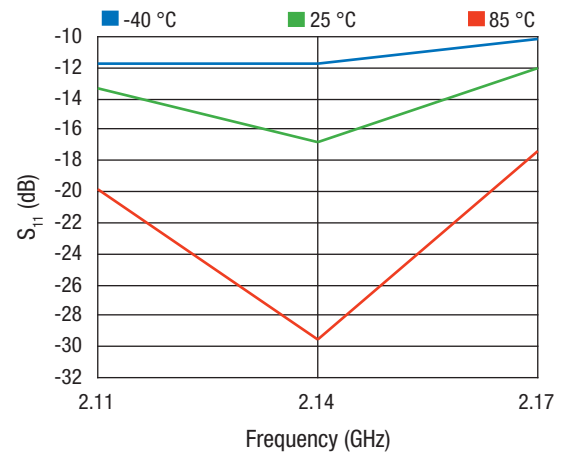

$S_{11}$  vs. Frequency Across Temperature

## Theory of Operation

The SKY65120 is comprised of two amplifier stages. The matching circuits for the input stage, inter-stage, and output stage are contained within the device. An on-chip active bias circuit is included within the device for both input and output stages providing for excellent gain tracking over temperature and voltage variations.

The SKY65120 is internally matched for optimum linearity and efficiency. The input and output stages are independently supplied using the  $V_{CC1}$  and  $V_{CC2}$  supply lines, pins 13 and 11, respectively. The bias reference voltages for stages 1 and 2 are supplied using common lines  $V_{REF1}$  and  $V_{REF2}$  (pins 6 and 7) line. The DC control voltage that sets the bias to stages 1 and 2 is supplied via  $V_{C\_BIAS}$ , pin 4.

## Application Circuit Notes

**Center Ground.** It is extremely important that the device paddle be sufficiently grounded for both thermal and stability reasons. Multiple small vias are acceptable and will work well under the device if solder migration is an issue.

**Ground (Pins 1, 2, 3, 8, 10, 17, 19, 20).** Attach all ground pins to the RF ground plane with the largest diameter and lowest inductance via that the layout will allow. Multiple small vias are also acceptable and will work well under the device if solder migration is an issue.

**No Connect (Pins 5, 12, 14, 15, 18).** The pins are open and may or may not be connected to ground.

**$V_{C\_BIAS}$  (Pin 4).**  $V_{C\_BIAS}$  is the bias supply voltage for stages 1 and 2. Typically set to 5 V.

**$V_{REF1}$  (Pin 6).** Bias reference voltage for amplifier stage 1.  $V_{REF1}$  should be operated over the the same voltage range as  $V_{CC}$ , with a nominal voltage of 5 V.

**$V_{REF2}$  (Pin 7).** Bias reference voltage for amplifier stage 2.  $V_{REF2}$  should be operated over the the same voltage range as  $V_{CC}$ , with a nominal voltage of 5 V.

**RF\_OUT (Pin 9).** Amplifier RF Output Pin.  $Z_0 = 50\ \Omega$ . The module includes an onboard internal DC blocking capacitor. All impedance matching is provided internal to the module.

**$V_{CC2}$  (Pin 11).** Supply voltage for the output (final) stage collector bias (typically 5 V). Bypassing of  $V_{CC2}$  is accomplished with C10, C11 and C12 and should be placed in the approximate location shown on the evaluation board, but placement is not critical.

**$V_{CC1}$  (Pin 13).** Supply voltage for the first stage collector bias (typically 5 V). Bypassing of  $V_{CC1}$  is accomplished with C6, C7 and C8 and should be placed in the approximate location shown on the evaluation board, but placement is not critical.

**RF\_IN (Pin 16).** Amplifier RF Input Pin.  $Z_0 = 50\ \Omega$ . The module includes an onboard internal DC blocking capacitor. All impedance matching is provided internal to the module.

### Package and Handling Information

Since the device package is sensitive to moisture absorption, it is baked and vacuum packed before shipping. Instructions on the shipping container label regarding exposure to moisture after the container seal is broken must be followed. Otherwise, problems related to moisture absorption may occur when the part is subjected to high temperature during solder assembly.

Please refer to Skyworks' *Solder Reflow* application note, available at [www.skyworksinc.com](http://www.skyworksinc.com), for instructions on mounting the SKY65120 to a printed circuit board.

Production quantities of this product are shipped in a standard tape and reel format. For packaging details, refer to the Skyworks *Tape and Reel* application note, document number 101568.

### Electrostatic Discharge (ESD) Sensitivity

The SKY65120 is a static-sensitive electronic device. Do not operate or store near strong electrostatic fields. Take proper ESD precautions.

### Application Circuit

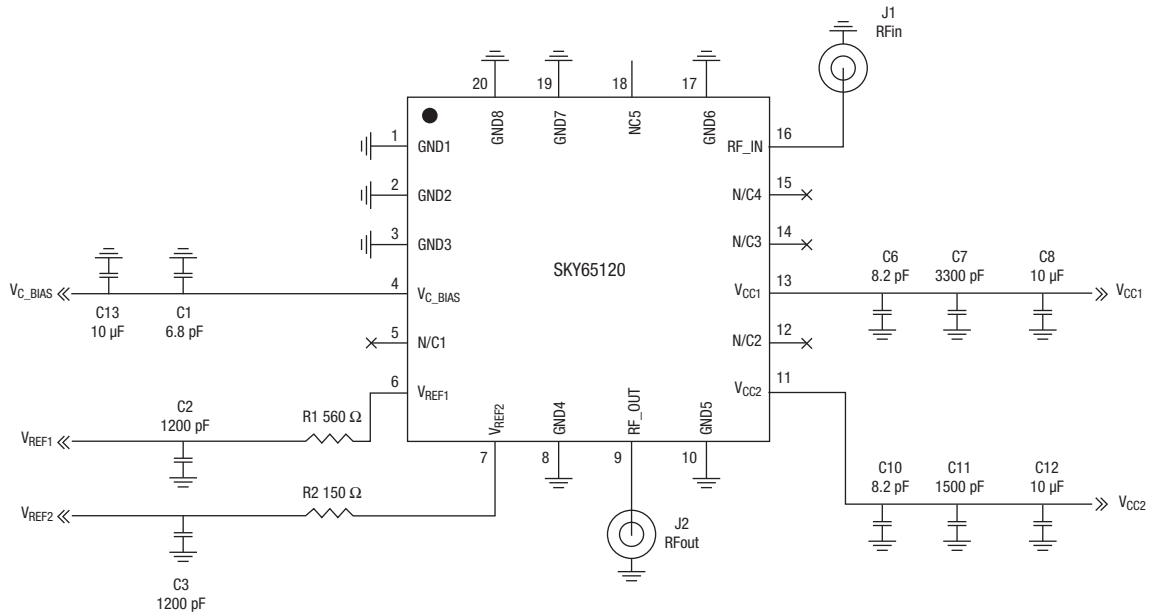



## Pin Assignments

Pin	Pin Name	Description
1	GND	Low inductance ground connection
2	GND	Low inductance ground connection
3	GND	Low inductance ground connection
4	V <sub>C_BIAS</sub>	Bias voltage
5	N/C	No connect
6	V <sub>REF1</sub>	Bias reference voltage 1
7	V <sub>REF2</sub>	Bias reference voltage 2
8	GND	Low inductance ground connection
9	RF_OUT	RF output
10	GND	Low inductance ground connection
11	V <sub>CC2</sub>	Stage 2 collector voltage
12	N/C	No connect
13	V <sub>CC1</sub>	Stage 1 collector voltage
14	N/C	No connect
15	N/C	No connect
16	RF_IN	RF input
17	GND	Low inductance ground connection
18	N/C	No connect
19	GND	Low inductance ground connection
20	GND	Low inductance ground connection

Center attachment pad must have a low inductance and low thermal resistance connection to the customer's printed circuit board ground plane.

## Evaluation Board Description

The Skyworks SKY65120 Evaluation Board is used to test the performance of the SKY65120 power amplifier module. The following design considerations are general in nature and must be followed regardless of final use or configuration.

1. Paths to ground should be made as short as possible.
2. The ground pad of the SKY65120 power amplifier module has special electrical and thermal grounding requirements. This pad is the main thermal conduit for heat dissipation. Since the circuit board acts as the heat sink, it must shunt as much heat as possible from the amplifiers. As such, design the connection to the ground pad to dissipate the maximum wattage produced to the circuit. Multiple vias to the grounding layer are required.

**NOTE:** Junction temperature ( $T_j$ ) of the device increases with a poor connection to the slug and ground. This reduces the lifetime of the device.

## Evaluation Board

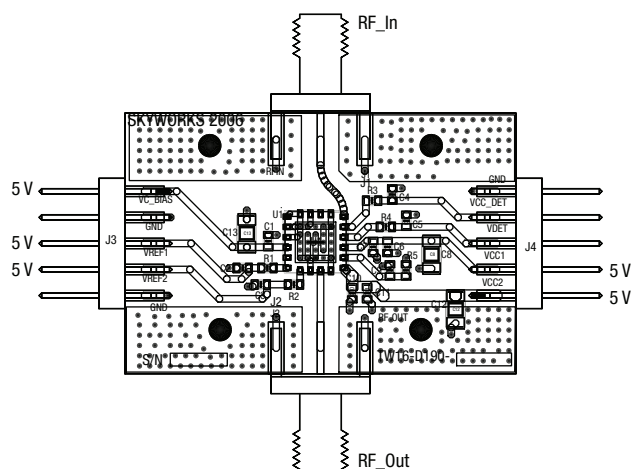

## Application Board Test Procedure

- Step 1. Connect RF test equipment to amplifier input/output SMA connectors.
- Step 2. Connect DC ground.
- Step 3. Connect all V<sub>CC</sub>, V<sub>REG</sub> and V<sub>C\_BIAS</sub> lines to 5 V supply. Verify the I<sub>CQ</sub> current is approximately 447 mA.
- Step 4. Apply RF signal data -20 dBm level and observe that the output level is approximately 4.6 dBm or the gain of the device is approximately 24.6 dB.

**NOTE:** It is important that the V<sub>CC1</sub> and V<sub>CC2</sub> voltage source be adjusted such that 5 V is measured at the board. The high collector currents will drop the collector voltage significantly if long leads are used. Adjust the bias voltage to compensate.

## Recommended Solder Reflow Profiles

Refer to the [“Recommended Solder Reflow Profile”](#) Application Note.

## Tape and Reel Information

Refer to the [“Discrete Devices and IC Switch/Attenuators Tape and Reel Package Orientation”](#) Application Note.

### Bill of Material for Evaluation Board

Part	ID	QTY	Size	Value	Units	Product Number	Manufacturer	Manufacturer's Part Number	Characteristics
1	C1	1	0603	6.8	pF	5404R23-045	Murata	GRM1885C1H6R8CD01J	COG, 50 V, ± 0.25 pF
2	C2	1	0603	1200	pF	SK204-000-002	Murata	GRM1887U1H122J	U2J, 50 V, ± 5%
3	C3	1	0603	1200	pF	SK204-000-002	Murata	GRM1887U1H122J	U2J, 50 V, ± 5%
4	C6	1	0603	8.2	pF	5404R23-046	Murata	GRM1885C1H6R8CZ01D	COG, 50 V, ± 0.25 pF
5	C7	1	0603	3300	pF	5404R28-015	Murata	GRM188R71H332KD01J	X7R, 50 V, ± 10%
6	C8	1	1206	10	µF	5404R91-005	TDK	C3216X5R0J106KT	X5R, 6 V, ± 10%
7	C10	1	0603	8.2	pF	5404R23-046	Murata	GRM1885C1H6R8CZ01D	COG, 50 V, ± 0.25 pF
8	C11	1	0603	1500	pF	5404R24-015	AVX	06031C152MATMA	X7R, 100 V, ± 20%
9	C12	1	1206	10	µF	5404R91-005	TDK	C3216X5R0J106KT	X5R, 6 V, ± 10%
10	C13	1	1206	10	µF	5404R91-005	TDK	C3216X5R0J106KT	X5R, 6 V, ± 10%
11	R1	1	0603	560	Ω	5424R20-043	Rohm	MCR03EZHUJ560	50 V, 0.063 W, ± 5%
12	R2	1	0603	150	Ω	5424R19-114	Rohm	MCR03EZHUF150	50 V, 0.063 W, ± 1%

### Evaluation Board Stack-Up

Cross Section	Name	Thickness (mils)	Material	ε <sub>r</sub>
	L1	1.4	Cu	-
	Lam1	12	Rogers 4003-12	3.38
	L2_GND	1.4	Cu, 1 oz.	-
	Lam2	4	FR4-4	4.35
	L3_GND	1.4	Cu, 1 oz.	-
	Lam3	12	FR4-12	4.35
	L4	1.4	Cu, 1 oz.	-

### Branding Specifications

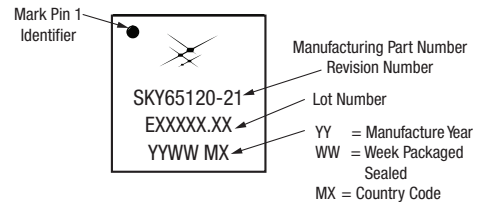

### Package Dimensions

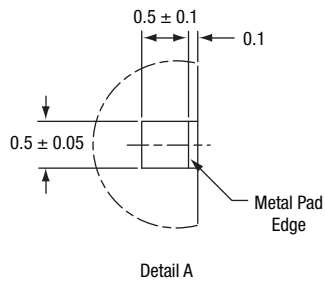
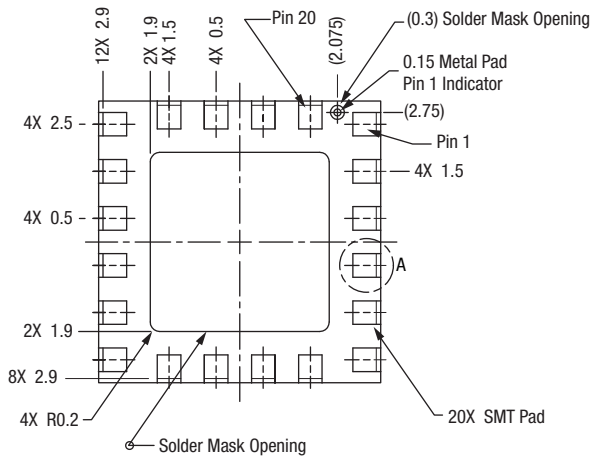
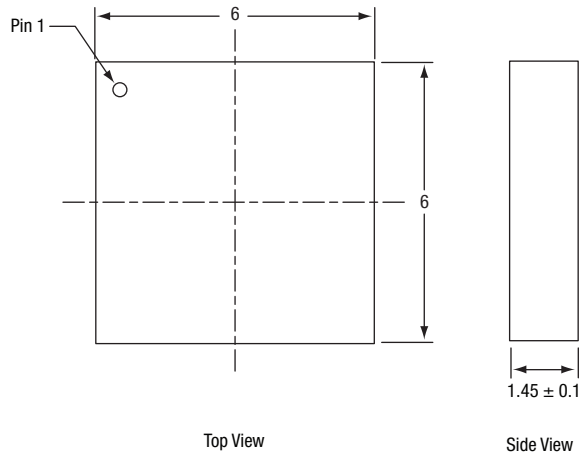

All dimensions are in millimeters  
 Dimensioning and tolerancing according  
 to ASME Y14.5M-1994

### Tape and Reel Dimensions

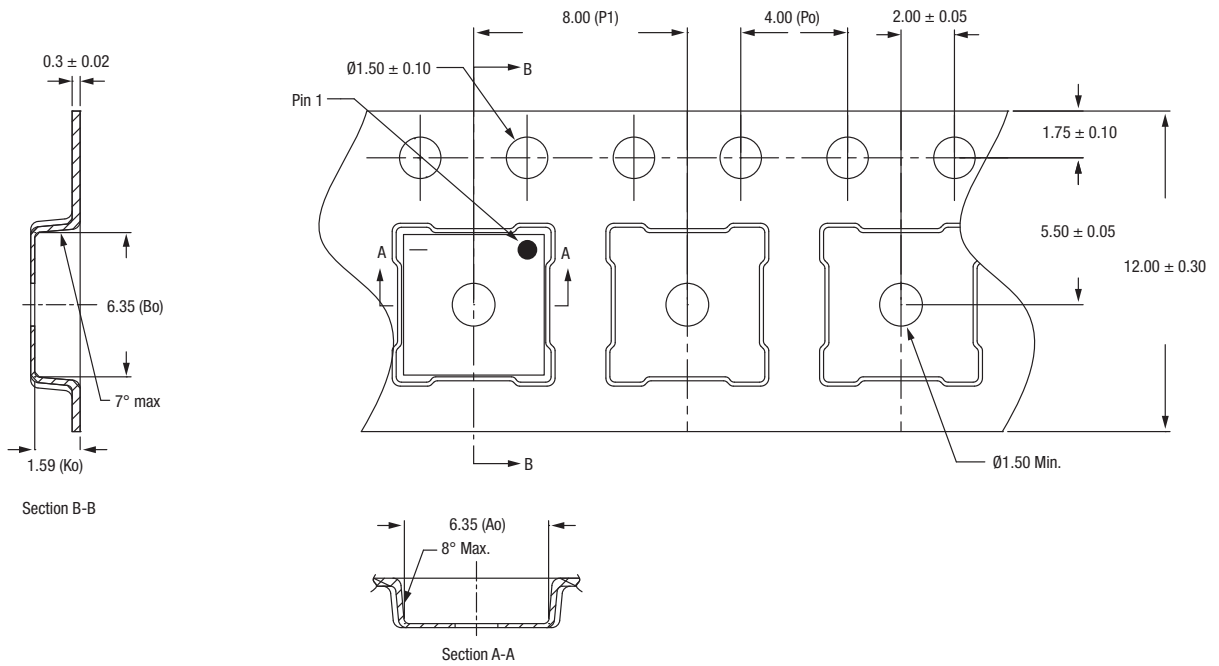

1. Carrier tape: black conductive polystyrene
2. Cover tape material: transparent conductive PSA
3. Cover tape size: 9.3 mm width
4. All dimensions are in millimeters

## Ordering Information

Model Name	Manufacturing Part Number	Evaluation Kit Part Number
SKY65120: 2110–2170 MHz High Linearity 2 W Power Amplifier	SKY65120-21 (Pb-free package)	TW16-D190

Copyright © 2008, Skyworks Solutions, Inc. All Rights Reserved.

Information in this document is provided in connection with Skyworks Solutions, Inc. (“Skyworks”) products or services. These materials, including the information contained herein, are provided by Skyworks as a service to its customers and may be used for informational purposes only by the customer. Skyworks assumes no responsibility for errors or omissions in these materials or the information contained herein. Skyworks may change its documentation, products, services, specifications or product descriptions at any time, without notice. Skyworks makes no commitment to update the materials or information and shall have no responsibility whatsoever for conflicts, incompatibilities, or other difficulties arising from any future changes.

No license, whether express, implied, by estoppel or otherwise, is granted to any intellectual property rights by this document. Skyworks assumes no liability for any materials, products or information provided hereunder, including the sale, distribution, reproduction or use of Skyworks products, information or materials, except as may be provided in Skyworks Terms and Conditions of Sale.

THE MATERIALS, PRODUCTS AND INFORMATION ARE PROVIDED “AS IS” WITHOUT WARRANTY OF ANY KIND, WHETHER EXPRESS, IMPLIED, STATUTORY, OR OTHERWISE, INCLUDING FITNESS FOR A PARTICULAR PURPOSE OR USE, MERCHANTABILITY, PERFORMANCE, QUALITY OR NON-INFRINGEMENT OF ANY INTELLECTUAL PROPERTY RIGHT; ALL SUCH WARRANTIES ARE HEREBY EXPRESSLY DISCLAIMED. SKYWORKS DOES NOT WARRANT THE ACCURACY OR COMPLETENESS OF THE INFORMATION, TEXT, GRAPHICS OR OTHER ITEMS CONTAINED WITHIN THESE MATERIALS. SKYWORKS SHALL NOT BE LIABLE FOR ANY DAMAGES, INCLUDING BUT NOT LIMITED TO ANY SPECIAL, INDIRECT, INCIDENTAL, STATUTORY, OR CONSEQUENTIAL DAMAGES, INCLUDING WITHOUT LIMITATION, LOST REVENUES OR LOST PROFITS THAT MAY RESULT FROM THE USE OF THE MATERIALS OR INFORMATION, WHETHER OR NOT THE RECIPIENT OF MATERIALS HAS BEEN ADVISED OF THE POSSIBILITY OF SUCH DAMAGE.

Skyworks products are not intended for use in medical, lifesaving or life-sustaining applications, or other equipment in which the failure of the Skyworks products could lead to personal injury, death, physical or environmental damage. Skyworks customers using or selling Skyworks products for use in such applications do so at their own risk and agree to fully indemnify Skyworks for any damages resulting from such improper use or sale.

Customers are responsible for their products and applications using Skyworks products, which may deviate from published specifications as a result of design defects, errors, or operation of products outside of published parameters or design specifications. Customers should include design and operating safeguards to minimize these and other risks. Skyworks assumes no liability for applications assistance, customer product design, or damage to any equipment resulting from the use of Skyworks products outside of stated published specifications or parameters.

Skyworks, the Skyworks symbol, and “Breakthrough Simplicity” are trademarks or registered trademarks of Skyworks Solutions, Inc., in the United States and other countries. Third-party brands and names are for identification purposes only, and are the property of their respective owners. Additional information, including relevant terms and conditions, posted at [www.skyworksinc.com](http://www.skyworksinc.com), are incorporated by reference.