



TS7900A series

3-Terminal Fixed Negative Output Voltage Regulator

TO-220



TO-263



1 2 3

Pin assignment:
 1. Ground
 2. Input
 3. Output
 (Heatsink surface
 connected to Pin 2)

Voltage Range - 5V to - 24V
Output Current up to 1.5A

General Description

The TS7900A series of fixed output negative voltage regulators are intended as complements to the popular TS7800A series device. These negative regulators are available in the same seven-voltage options as the TS7800A devices.

Available in fixed output voltage options from -5.0 to -24 volts, these regulators employ current limiting, thermal shutdown, and safe-area compensation--making them remarkably rugged under most operating conditions. With adequate heat sink they can deliver output currents in excess of 1.5 ampere.

This series is offered in 3-pin TO-220, TO-263 package.

Features

- ◇ Output current up to 1.5A
- ◇ No external components required
- ◇ Internal thermal overload protection
- ◇ Internal short-circuit current limiting
- ◇ Output transistor safe-area compensation
- ◇ Output voltage offered in +/-2% tolerance

Standard Application

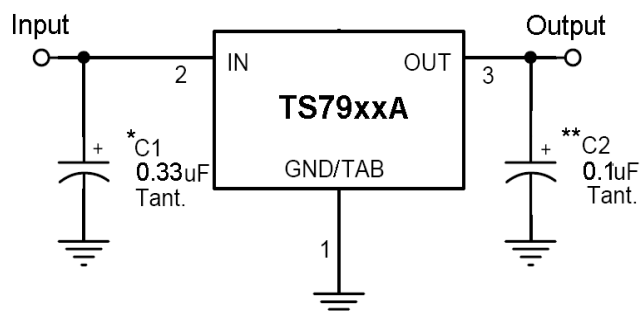

A common ground is required between the input and the output voltages. The input voltage must remain typically 2.0V above the output voltage even during the low point on the Input ripple voltage.

XX = these two digits of the type number indicate voltage.

* = Cin is required if regulator is located an appreciable distance from power supply filter.

** = Co is not needed for stability; however, it does improve transient response.

Ordering Information

Part No.	Operating Temp. (Ambient)	Package
TS79xxACZ	-20 ~ +85°C	TO-220
TS79xxACM		TO-263

Note: Where xx denotes voltage option.

Absolute Maximum Rating

Input Voltage	V_{in}^*	- 35	V
Input Voltage	V_{in}^{**}	- 40	V
Power Dissipation	TO-220	Without heatsink	2
	TO-220	Pt ***	15
	TO-263	Without heatsink	1.5
Operating Junction Temperature Range	T_J	0 ~ +150	°C
Storage Temperature Range	T_{STG}	-65 ~ +150	°C

Note : * TS7905A to TS7918A

** TS7924A

*** Follow the derating curve



TS7905A Electrical Characteristics

($V_{in} = -10V$, $I_{out} = 500mA$, $0^{\circ}C \leq T_j \leq 125^{\circ}C$, $C_{in} = 0.33\mu F$, $C_{out} = 0.1\mu F$; unless otherwise specified.)

Parameter	Symbol	Test Conditions	Min	Typ	Max	Unit	
Output voltage	V_{out}	$T_j = 25^{\circ}C$	-4.90	-5	-5.10	V	
		$-7.5V \leq V_{in} \leq -20V$, $10mA \leq I_{out} \leq 1A$, $PD \leq 15W$	-4.80	-5	-5.20		
Line Regulation	REGline	$T_j = 25^{\circ}C$	$-7.5V \leq V_{in} \leq -25V$	--	3	100	mV
			$-8V \leq V_{in} \leq -12V$	--	1	50	
Load Regulation	REGload	$T_j = 25^{\circ}C$	$10mA \leq I_{out} \leq 1.5A$	--	15	100	
			$250mA \leq I_{out} \leq 750mA$	--	5	50	
Quiescent Current	I_q	$I_{out} = 0$, $T_j = 25^{\circ}C$	--	4	8	mA	
Quiescent Current Change	ΔI_q	$-7.5V \leq V_{in} \leq -25V$	--	--	1.3		
		$10mA \leq I_{out} \leq 1A$	--	--	0.5		
Output Noise Voltage	V_n	$10Hz \leq f \leq 100KHz$, $T_j = 25^{\circ}C$	--	40	--	μV	
Ripple Rejection Ratio	RR	$f = 120Hz$, $-8V \leq V_{in} \leq -18V$	62	74	--	dB	
Voltage Drop	V_{drop}	$I_{out} = 1.0A$, $T_j = 25^{\circ}C$	--	2	--	V	
Peak Output Current	$I_{o\ peak}$	$T_j = 25^{\circ}C$	--	2.1	--	A	
Temperature Coefficient of Output Voltage	$\Delta V_{out}/\Delta T_j$	$I_{out} = 10mA$, $0^{\circ}C \leq T_j \leq 125^{\circ}C$	--	-1	--	mV/ $^{\circ}C$	

TS7908A Electrical Characteristics

($V_{in} = -14V$, $I_{out} = 500mA$, $0^{\circ}C \leq T_j \leq 125^{\circ}C$, $C_{in} = 0.33\mu F$, $C_{out} = 0.1\mu F$; unless otherwise specified.)

Parameter	Symbol	Test Conditions	Min	Typ	Max	Unit	
Output Voltage	V_{out}	$T_j = 25^{\circ}C$	-7.84	-8	-8.16	V	
		$-10.5V \leq V_{in} \leq -23V$, $10mA \leq I_{out} \leq 1A$, $PD \leq 15W$	-7.68	-8	-8.32		
Line Regulation	REGline	$T_j = 25^{\circ}C$	$-10.5V \leq V_{in} \leq -25V$	--	6	160	mV
			$-11V \leq V_{in} \leq -17V$	--	2	80	
Load Regulation	REGload	$T_j = 25^{\circ}C$	$10mA \leq I_{out} \leq 1.5A$	--	12	160	
			$250mA \leq I_{out} \leq 750mA$	--	4	80	
Quiescent Current	I_q	$I_{out} = 0$, $T_j = 25^{\circ}C$	--	4	8	mA	
Quiescent Current Change	ΔI_q	$-10.5V \leq V_{in} \leq -25V$	--	--	1		
		$10mA \leq I_{out} \leq 1A$	--	--	0.5		
Output Noise Voltage	V_n	$10Hz \leq f \leq 100KHz$, $T_j = 25^{\circ}C$	--	52	--	μV	
Ripple Rejection Ratio	RR	$f = 120Hz$, $-11V \leq V_{in} \leq -21V$	56	72	--	dB	
Voltage Drop	V_{drop}	$I_{out} = 1.0A$, $T_j = 25^{\circ}C$	--	2	--	V	
Peak Output Current	$I_{o\ peak}$	$T_j = 25^{\circ}C$	--	2.1	--	A	
Temperature Coefficient of Output Voltage	$\Delta V_{out}/\Delta T_j$	$I_{out} = 10mA$, $0^{\circ}C \leq T_j \leq 125^{\circ}C$	--	-1	--	mV/ $^{\circ}C$	

- Pulse testing techniques are used to maintain the junction temperature as close to the ambient temperature as possible, and thermal effects must be taken into account separately.
- This specification applies only for DC power dissipation permitted by absolute maximum ratings.



TS7909A Electrical Characteristics

($V_{in} = -15V$, $I_{out} = 500mA$, $0^{\circ}C \leq T_j \leq 125^{\circ}C$, $C_{in} = 0.33\mu F$, $C_{out} = 0.1\mu F$; unless otherwise specified.)

Parameter	Symbol	Test Conditions	Min	Typ	Max	Unit	
Output Voltage	Vout	$T_j = 25^{\circ}C$	-8.88	-9	-9.18	V	
		$-11.5V \leq V_{in} \leq -23V$, $10mA \leq I_{out} \leq 1A$, $PD \leq 15W$	-8.64	-9	-9.36		
Line Regulation	REGline	$T_j = 25^{\circ}C$	$-11.5V \leq V_{in} \leq -26V$	--	6	180	mV
			$-12V \leq V_{in} \leq -17V$	--	2	90	
Load Regulation	REGload	$T_j = 25^{\circ}C$	$10mA \leq I_{out} \leq 1.5A$	--	12	180	mV
			$250mA \leq I_{out} \leq 750mA$	--	4	90	
Quiescent Current	Iq	$I_{out} = 0$, $T_j = 25^{\circ}C$	--	4	8	mA	
Quiescent Current Change	ΔIq	$-11.5V \leq V_{in} \leq -26V$	--	--	1		
		$10mA \leq I_{out} \leq 1A$	--	--	0.5		
Output Noise Voltage	Vn	$10Hz \leq f \leq 100KHz$, $T_j = 25^{\circ}C$	--	58	--	μV	
Ripple Rejection Ratio	RR	$f = 120Hz$, $-12V \leq V_{in} \leq -22V$	56	71	--	dB	
Voltage Drop	Vdrop	$I_{out} = 1.0A$, $T_j = 25^{\circ}C$	--	2	--	V	
Peak Output Current	I _{o peak}	$T_j = 25^{\circ}C$	--	2.1	--	A	
Temperature Coefficient of Output Voltage	$\Delta V_{out}/\Delta T_j$	$I_{out} = 10mA$, $0^{\circ}C \leq T_j \leq 125^{\circ}C$	--	-1	--	mV/ $^{\circ}C$	

TS7912A Electrical Characteristics

($V_{in} = -19V$, $I_{out} = 500mA$, $0^{\circ}C \leq T_j \leq 125^{\circ}C$, $C_{in} = 0.33\mu F$, $C_{out} = 0.1\mu F$; unless otherwise specified.)

Parameter	Symbol	Test Conditions	Min	Typ	Max	Unit	
Output Voltage	Vout	$T_j = 25^{\circ}C$	-11.76	-12	-12.24	V	
		$-14.5V \leq V_{in} \leq -27V$, $10mA \leq I_{out} \leq 1A$, $PD \leq 15W$	-11.52	-12	-12.48		
Line Regulation	REGline	$T_j = 25^{\circ}C$	$-14.5V \leq V_{in} \leq -30V$	--	10	240	mV
			$-15V \leq V_{in} \leq -19V$	--	3	120	
Load Regulation	REGload	$T_j = 25^{\circ}C$	$10mA \leq I_{out} \leq 1.5A$	--	12	240	mV
			$250mA \leq I_{out} \leq 750mA$	--	4	120	
Quiescent Current	Iq	$T_j = 25^{\circ}C$, $I_{out} = 0$	--	4	8	mA	
Quiescent Current Change	ΔIq	$-14.5V \leq V_{in} \leq -30V$	--	--	1		
		$10mA \leq I_{out} \leq 1A$	--	--	0.5		
Output Noise Voltage	Vn	$10Hz \leq f \leq 100KHz$, $T_j = 25^{\circ}C$	--	75	--	μV	
Ripple Rejection Ratio	RR	$f = 120Hz$, $15V \leq V_{in} \leq 25V$	55	70	--	dB	
Voltage Drop	Vdrop	$I_{out} = 1.0A$, $T_j = 25^{\circ}C$	--	2	--	V	
Peak Output Current	I _{o peak}	$T_j = 25^{\circ}C$	--	2.1	--	A	
Temperature Coefficient of Output Voltage	$\Delta V_{out}/\Delta T_j$	$I_{out} = 10mA$, $0^{\circ}C \leq T_j \leq 125^{\circ}C$	--	-1	--	mV/ $^{\circ}C$	

- Pulse testing techniques are used to maintain the junction temperature as close to the ambient temperature as possible, and thermal effects must be taken into account separately.
- This specification applies only for DC power dissipation permitted by absolute maximum ratings.



TS7915A Electrical Characteristics

($V_{in} = -23V$, $I_{out} = 500mA$, $0^{\circ}C \leq T_j \leq 125^{\circ}C$, $C_{in} = 0.33\mu F$, $C_{out} = 0.1\mu F$; unless otherwise specified.)

Parameter	Symbol	Test Conditions	Min	Typ	Max	Unit	
Output Voltage	V_{out}	$T_j = 25^{\circ}C$	-14.70	-15	-15.30	V	
		$-17.5V \leq V_{in} \leq -30V$, $10mA \leq I_{out} \leq 1A$, $PD \leq 15W$	-14.40	-15	-15.60		
Line Regulation	REGline	$T_j = 25^{\circ}C$	$-17.5V \leq V_{in} \leq -30V$	--	12	300	mV
			$-18V \leq V_{in} \leq -22V$	--	3	150	
Load Regulation	REGload	$T_j = 25^{\circ}C$	$10mA \leq I_{out} \leq 1.5A$	--	12	300	mV
			$250mA \leq I_{out} \leq 750mA$	--	4	150	
Quiescent Current	I_q	$T_j = 25^{\circ}C$, $I_{out} = 0$	--	4	8	mA	
Quiescent Current Change	ΔI_q	$-17.5V \leq V_{in} \leq -30V$	--	--	1		
		$10mA \leq I_{out} \leq 1A$	--	--	0.5		
Output Noise Voltage	V_n	$10Hz \leq f \leq 100KHz$, $T_j = 25^{\circ}C$	--	90	--	μV	
Ripple Rejection Ratio	RR	$f = 120Hz$, $-18V \leq V_{in} \leq -28V$	54	69	--	dB	
Voltage Drop	V_{drop}	$I_{out} = 1.0A$, $T_j = 25^{\circ}C$	--	2	--	V	
Peak Output Current	$I_{o\ peak}$	$T_j = 25^{\circ}C$	--	2.1	--	A	
Temperature Coefficient of Output Voltage	$\Delta V_{out}/\Delta T_j$	$I_{out} = 10mA$, $0^{\circ}C \leq T_j \leq 125^{\circ}C$	--	-1	--	$mV/^{\circ}C$	

TS79818A Electrical Characteristics

($V_{in} = -27V$, $I_{out} = 500mA$, $0^{\circ}C \leq T_j \leq 125^{\circ}C$, $C_{in} = 0.33\mu F$, $C_{out} = 0.1\mu F$; unless otherwise specified.)

Parameter	Symbol	Test Conditions	Min	Typ	Max	Unit	
Output Voltage	V_{out}	$T_j = 25^{\circ}C$	-17.64	-18	-18.36	V	
		$-21V \leq V_{in} \leq -33V$, $10mA \leq I_{out} \leq 1A$, $PD \leq 15W$	-17.28	-18	-18.72		
Line Regulation	REGline	$T_j = 25^{\circ}C$	$-21V \leq V_{in} \leq -33V$	--	15	360	mV
			$-22V \leq V_{in} \leq -26V$	--	5	180	
Load Regulation	REGload	$T_j = 25^{\circ}C$	$10mA \leq I_{out} \leq 1.5A$	--	12	360	mV
			$250mA \leq I_{out} \leq 750mA$	--	4	180	
Quiescent Current	I_q	$T_j = 25^{\circ}C$, $I_{out} = 0$	--	4	8	mA	
Quiescent Current Change	ΔI_q	$-21V \leq V_{in} \leq -33V$	--	--	1		
		$10mA \leq I_{out} \leq 1A$	--	--	0.5		
Output Noise Voltage	V_n	$10Hz \leq f \leq 100KHz$, $T_j = 25^{\circ}C$	--	110	--	μV	
Ripple Rejection Ratio	RR	$f = 120Hz$, $-21V \leq V_{in} \leq -31V$	53	68	--	dB	
Voltage Drop	V_{drop}	$I_{out} = 1.0A$, $T_j = 25^{\circ}C$	--	2	--	V	
Peak Output Current	$I_{o\ peak}$	$T_j = 25^{\circ}C$	--	2.1	--	A	
Temperature Coefficient of Output Voltage	$\Delta V_{out}/\Delta T_j$	$I_{out} = 10mA$, $0^{\circ}C \leq T_j \leq 125^{\circ}C$	--	-1	--	$mV/^{\circ}C$	

- Pulse testing techniques are used to maintain the junction temperature as close to the ambient temperature as possible, and thermal effects must be taken into account separately.
- This specification applies only for DC power dissipation permitted by absolute maximum ratings.



TS7824A Electrical Characteristics

($V_{in} = -33V$, $I_{out} = 500mA$, $0^{\circ}C \leq T_j \leq 125^{\circ}C$, $C_{in} = 0.33\mu F$, $C_{out} = 0.1\mu F$; unless otherwise specified.)

Parameter	Symbol	Test Conditions	Min	Typ	Max	Unit	
Output Voltage	V_{out}	$T_j = 25^{\circ}C$	-23.52	-24	-24.48	V	
		$-27V \leq V_{in} \leq -38V$, $10mA \leq I_{out} \leq 1A$, $PD \leq 15W$	-23.04	-24	-24.96		
Line Regulation	REGline	$T_j = 25^{\circ}C$	$-27V \leq V_{in} \leq -38V$	--	18	480	mV
			$-28V \leq V_{in} \leq -32V$	--	6	240	
Load Regulation	REGload	$T_j = 25^{\circ}C$	$10mA \leq I_{out} \leq 1.5A$	--	12	480	mV
			$250mA \leq I_{out} \leq 750mA$	--	4	240	
Quiescent Current	I_q	$I_{out} = 0$, $T_j = 25^{\circ}C$	--	4	8	mA	
Quiescent Current Change	ΔI_q	$-27V \leq V_{in} \leq -38V$	--	--	1		
		$10mA \leq I_{out} \leq 1A$	--	--	0.5		
Output Noise Voltage	V_n	$10Hz \leq f \leq 100KHz$, $T_j = 25^{\circ}C$	--	170	--	μV	
Ripple Rejection Ratio	RR	$f = 120Hz$, $-27V \leq V_{in} \leq -37V$	50	65	--	dB	
Voltage Drop	V_{drop}	$I_{out} = 1.0A$, $T_j = 25^{\circ}C$	--	2	--	V	
Peak Output Current	$I_{o\ peak}$	$T_j = 25^{\circ}C$	--	2.1	--	A	
Temperature Coefficient of Output Voltage	$\Delta V_{out} / \Delta T_j$	$I_{out} = 10mA$, $0^{\circ}C \leq T_j \leq 125^{\circ}C$	--	-1	--	$mV / ^{\circ}C$	

- Pulse testing techniques are used to maintain the junction temperature as close to the ambient temperature as possible, and thermal effects must be taken into account separately.
- This specification applies only for DC power dissipation permitted by absolute maximum ratings.

Electrical Characteristics Curve

FIGURE 1 - Worst Case Power Dissipation v.s. Ambient Temperature

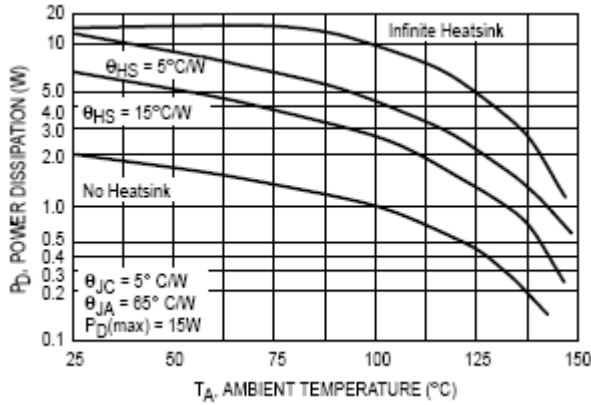

FIGURE 2 - Peak Output Current v.s. Input-Output Differential Voltage

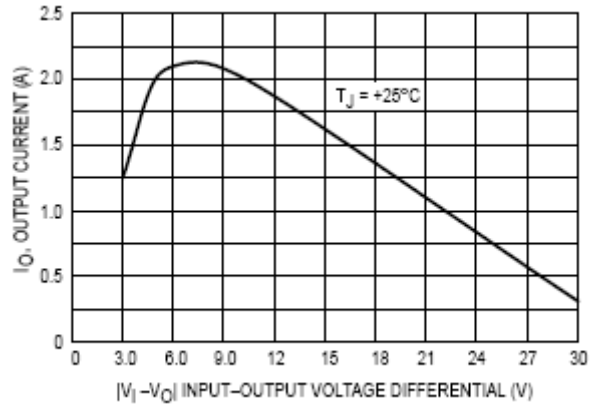

FIGURE 3 - Ripple Rejection v.s. Frequency

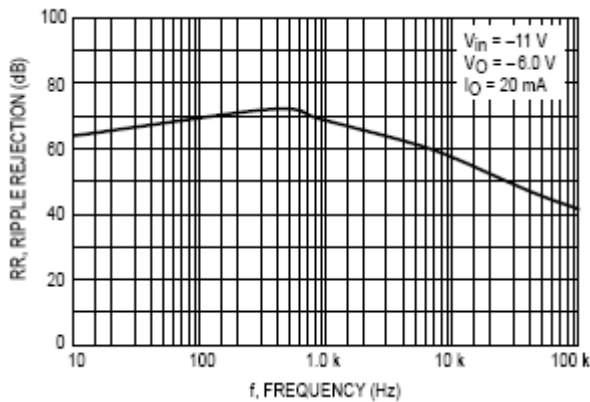

FIGURE 4 - Ripple Rejection v.s. Output Voltage

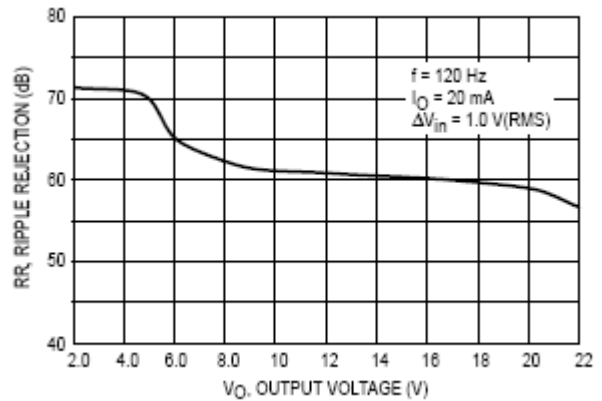

FIGURE 5 - Output Voltage v.s. Junction Temperature

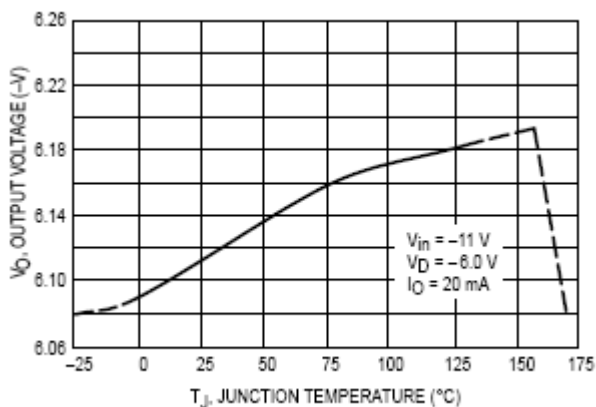
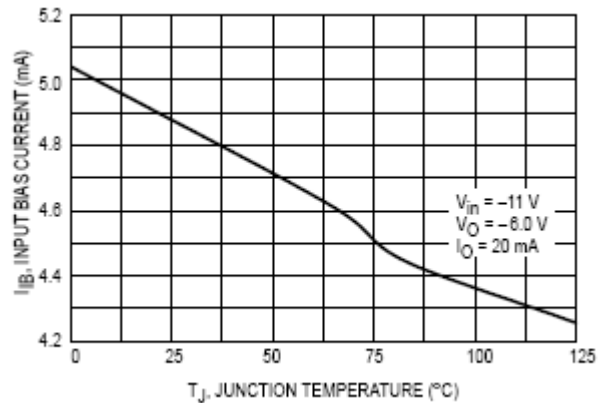
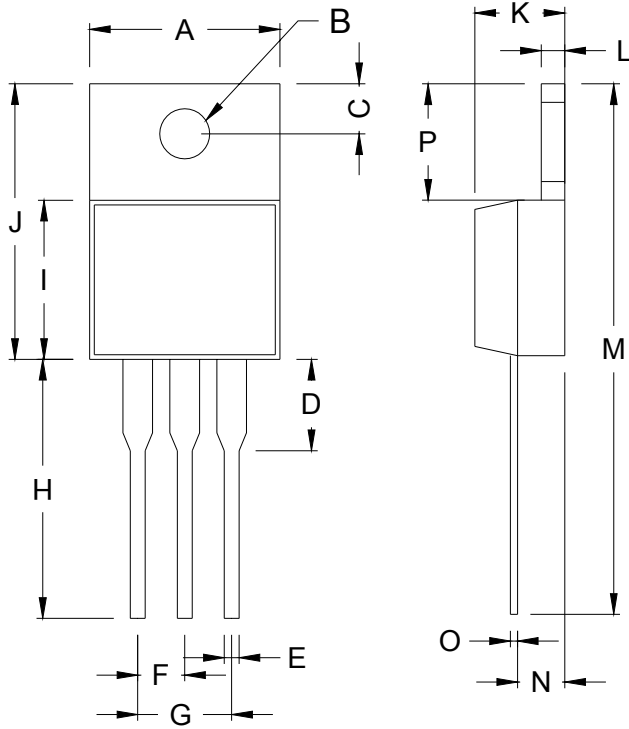

FIGURE 6 - Quiescent Current v.s. Temperature



TO-220 Mechanical Drawing



TO-220 DIMENSION				
DIM	MILLIMETERS		INCHES	
	MIN	MAX	MIN	MAX
A	10.000	10.500	0.394	0.413
B	3.240	4.440	0.128	0.175
C	2.440	2.940	0.096	0.116
D	-	6.350	-	0.250
E	0.381	1.106	0.015	0.040
F	2.345	2.715	0.092	0.058
G	4.690	5.430	0.092	0.107
H	12.700	14.732	0.500	0.581
I	8.382	9.017	0.330	0.355
J	14.224	16.510	0.560	0.650
K	3.556	4.826	0.140	0.190
L	0.508	1.397	0.020	0.055
M	27.700	29.620	1.060	1.230
N	2.032	2.921	0.080	0.115
O	0.255	0.610	0.010	0.024
P	5.842	6.858	0.230	0.270

TO-263 Mechanical Drawing

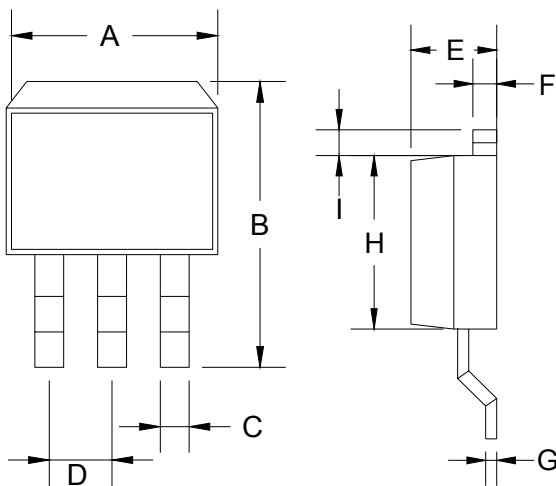

TO-263 DIMENSION				
DIM	MILLIMETERS		INCHES	
	MIN	MAX	MIN	MAX
A	10.000	10.500	0.394	0.413
B	14.605	15.875	0.575	0.625
C	0.508	0.991	0.020	0.039
D	2.420	2.660	0.095	0.105
E	4.064	4.830	0.160	0.190
F	1.118	1.400	0.045	0.055
G	0.450	0.730	0.018	0.029
H	8.280	8.800	0.325	0.346
I	1.140	1.400	0.044	0.055
J	1.480	1.520	0.058	0.060