

1500 Watts

- High Efficiency up to 92%
- High Power Density
- Programmable Output Voltage (0-105%)
- Programmable Output Current (0-105%)
- Parallel Operation
- Fully Featured Signals & Controls
- 3 Year Warranty



The HDS1500 series offers users both output voltage and output current programming (0 – 105%) via resistance, voltage or I²C bus in a very high efficiency, high power density 3 kW chassis mount package. Measuring just 12.32" x 2.5" x 5.0", the HDS1500 also features active current sharing, remote on/off, remote sense and a power OK signal. The standby output is available whenever the mains supply is present and can be user selected as either 5 V at 0.5 A or 9V at 0.3 A.

Dimensions:

HDS1500:

12.32 x 2.50 x 5.00" (294.5 x 63.5 x 127 mm)

Models & Ratings

Output Power	Output Voltage V1	Output Current		Efficiency ⁽¹⁾	Model Number
		Min	Max		
1500 W	12.0 VDC	0.0 A	125.0 A	89%	HDS1500PS12
1500 W	15.0 VDC	0.0 A	100.0 A	90%	HDS1500PS15
1500 W	24.0 VDC	0.0 A	62.5 A	91%	HDS1500PS24
1500 W	30.0 VDC	0.0 A	50.0 A	92%	HDS1500PS30
1500 W	36.0 VDC	0.0 A	41.7 A	92%	HDS1500PS36
1500 W	48.0 VDC	0.0 A	31.3 A	92%	HDS1500PS48
1500 W	60.0 VDC	0.0 A	25.0 A	93%	HDS1500PS60

Notes

1. Measured with 230 VAC input and full load.

Input

Characteristic	Minimum	Typical	Maximum	Units	Notes & Conditions
Input Voltage	90		264	VAC	See derating curve
Input Frequency	47		63	Hz	
Power Factor		0.99/0.98			115/230 VAC full load
Input Current			18/9	A	115/230 VAC
Inrush Current			30.0/60/0	A	115/230 VAC
Earth Leakage Current			1.0	mA	264 VAC/60 Hz
Input Protection	F20 A/250 V internal fuse				

Output

Characteristic	Minimum	Typical	Maximum	Units	Notes & Conditions
Output Voltage	12		60	VDC	See Models and Ratings table
Output Trim		±5.0		%	By potentiometer
Output Voltage Program	0		105	%	Of rated output
Output Current Program	0		105	%	Of rated output
Initial Set Accuracy			±1	%	
Minimum Load	0			A	
Start Up Delay			1	s	
Start Up Rise Time			120	ms	At full load
Hold Up Time	8			ms	
Line Regulation			±1	%	
Load Regulation			±1/±3	%	0-100% load. V1/5V standby
Transient Response			1	%	For a 25% step load change
Ripple & Noise			1	% pk-pk	1.25% for 12 V model. Measured with 20 MHz bandwidth and using 12" twisted pair wire terminated with 0.1 μF ceramic capacitor and 47 μF electrolytic.
Overvoltage Protection					Tracks output voltage, see application notes Recycle AC to reset
Overtemperature Protection					Primary and secondary heatsinks, monitored Output shuts down, auto recovers
Overload Protection		105		%	Rated power, constant current
Short Circuit Protection					Auto recovery
Temperature Coefficient		±0.02		%/°C	0-50 °C
Remote Sense	Compensates for 0.5 V max voltage drop, if remote sense is not required, local sense must be used				
Enable	Output must be enabled, see application notes, power supply is shipped with enable links fitted				
Current Share	5 supplies can share within 5%				
Standby Output	5 V at 0.5 A, present whenever AC is applied (9 V at 0.3 A, user selectable, by connecting 'VSET', Pin 18 of CN2 to GND)				

Output Voltage Programming

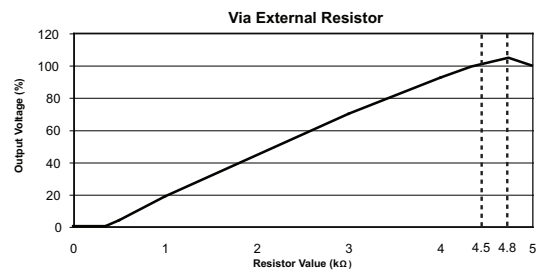
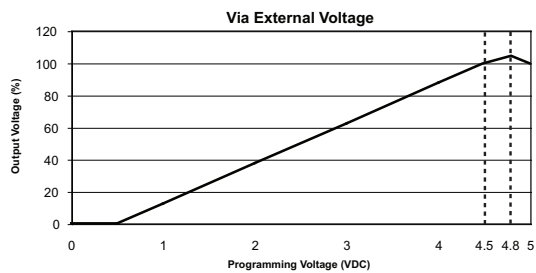

Output Current Programming

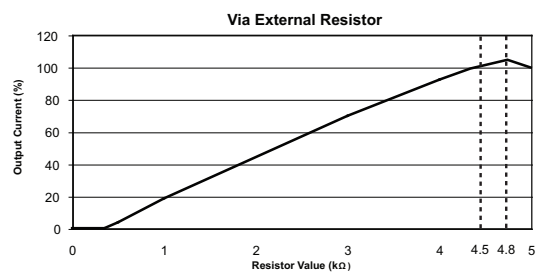
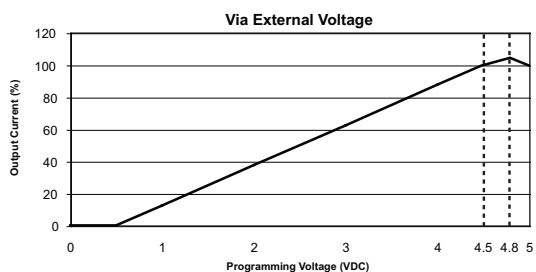

General

Characteristic	Minimum	Typical	Maximum	Units	Notes & Conditions
Efficiency	89		93	%	See Models and Ratings table
Isolation: Input to Output Input to Ground Output to Ground	3000			VAC	
	1500			VAC	
	500			VAC	
Switching Frequency		65		kHz	PFC
	40		200	kHz	PWM, variable
Power Density			9.7	W/in ³	
Signals and Controls					Enable, Current Share, V Program, I Program, 5 V Standby, Power OK
Mean Time Between Failure		115		kHrs	MIL-HDBK-217F, 25 °C GB
Weight		5.7 (2.6)		lb (kg)	

Environmental

Characteristic	Minimum	Typical	Maximum	Units	Notes & Conditions
Operating Temperature	-25		60	°C	Derate linearly from 100% load at 50 °C to 60% load at 60 °C
Storage Temperature	-40		+85	°C	
Cooling					Internal fan fitted, speed increases with load and internal temperature
Humidity	20		90	%RH	
Vibration			2	g	10-500 Hz, 10 min/cycle, 60 min period for each axis, compliant to IEC68-2-16, IEC 68-2-64

Derating Curve

Thermal Derating Curve

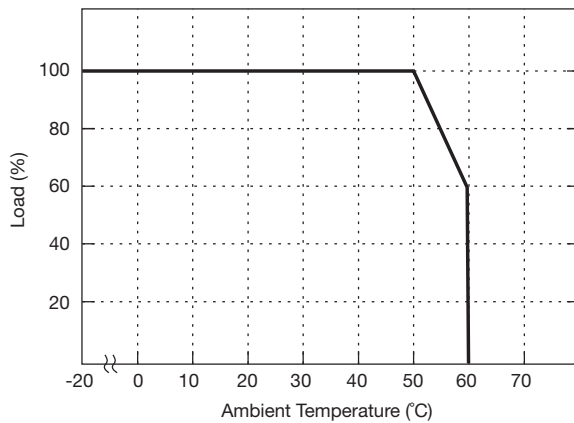

Input Derating Curve

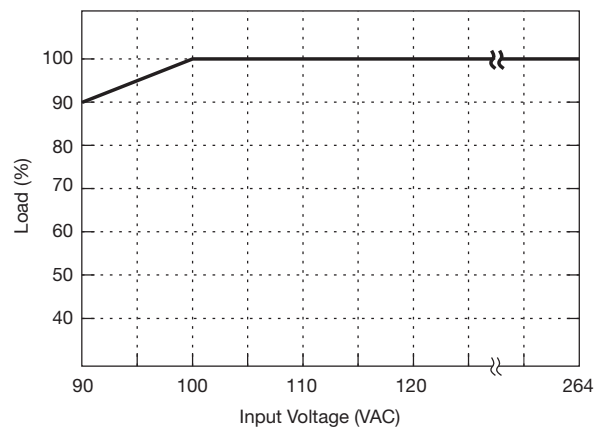

Signals & Controls

LED Status	Output Status
Solid (Green)	DC Output OK
Solid (Orange)	DC Output OK in remote control mode
Slow Blink (Green)	Output Not Enabled
Fast Blink (Red)	Over Voltage
Solid (Red)	Over Loaded
Slow Blink (Red)	Over Temperature
Intermittent Blink (Red)	Fan Fail
Short & Long Blink (Red)	AUX Standby Failure

Remote Enable

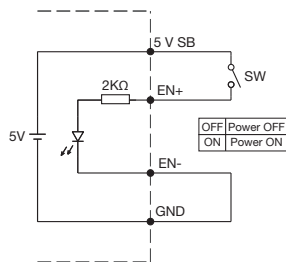

(A) Using internal 5 V standby

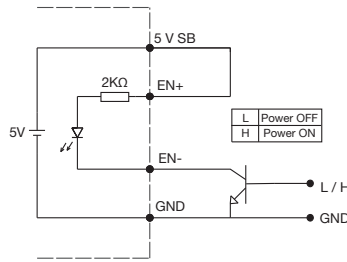

(B) Using external transistor

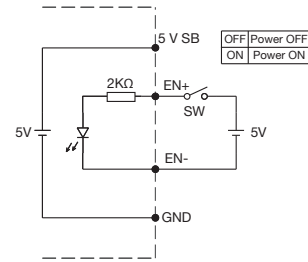

(C) Using external voltage source

EMC: Emissions

Phenomenon	Standard	Test Level	Notes & Conditions
Conducted	EN55022	Class B	
Radiated	EN55022	Class B	
Harmonic Currents	EN61000-3-2	Class A	
Voltage Flicker	EN61000-3-3		

EMC: Immunity

Phenomenon	Standard	Test Level	Criteria	Notes & Conditions
ESD Immunity	EN61000-4-2	2 / 3	A	±4 kV contact / ±8 kV air discharge
Radiated Immunity	EN61000-4-3	3	A	
EFT/Burst	EN61000-4-4	3	A	
Surge	EN61000-4-5	Installation class 3	A	
Conducted	EN61000-4-6	3	A	
Magnetic Field	EN61000-4-8	3	A	
Dips and Interruptions	EN55024	DIP: 30% 500 ms	A/B	High Line/Low Line
		INT: >95% 10 ms	A	
		INT: >95% 5000 ms	B	

Safety Approvals

Safety Agency	Safety Standard	Notes & Conditions
UL	UL60950-1	
CSA	C22.2 No.60950-1	
TUV	EN60950-1	

Application Notes

POK Signal

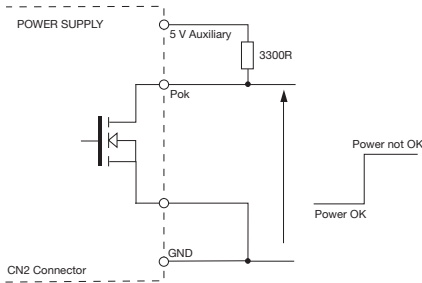

Open drain signal, low when PSU turns on
 Maximum sink current: 20 mA
 Maximum drain voltage: 40 V

OVP Setting

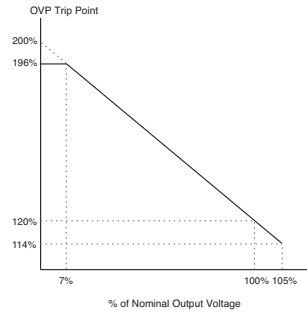

Remote Sense

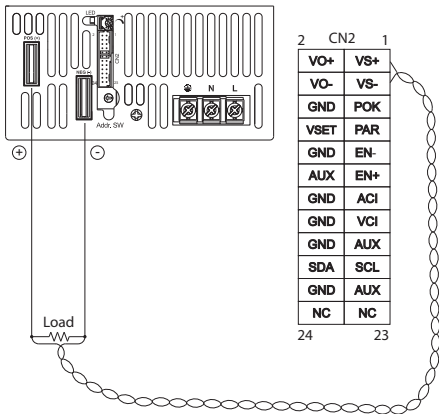

Current Sharing with Remote Sense

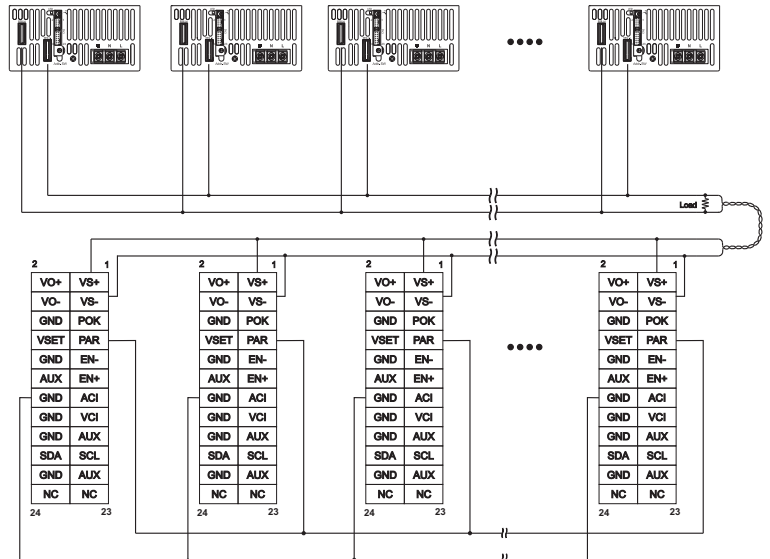

Local Sense

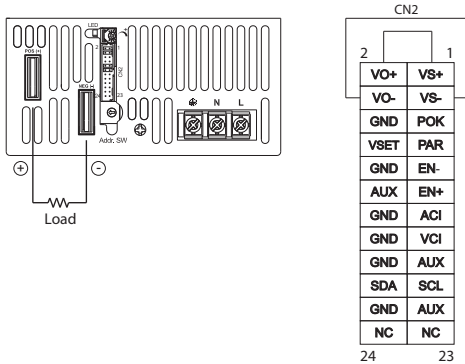

Must be used if remote sense is not required.

Current Sharing with Local Sense

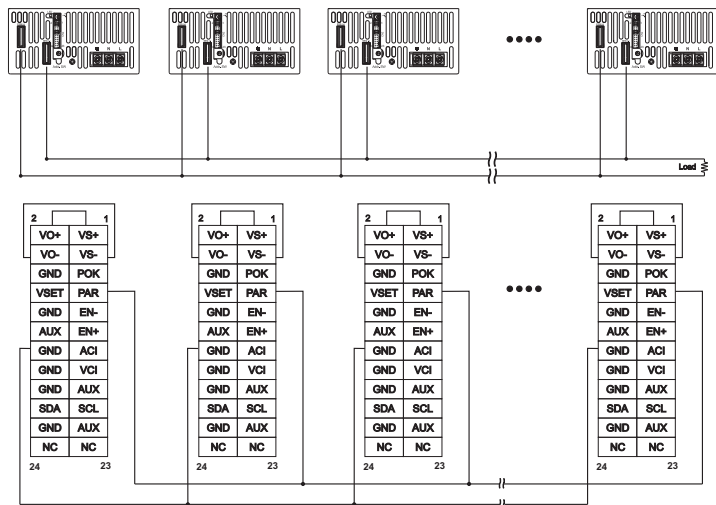

Notes

In parallel operation, it is possible that only one unit will operate if the load is less than 5% of the combined rated output load. It is possible to have more than five units in parallel, contact sales for details.

Mechanical Details

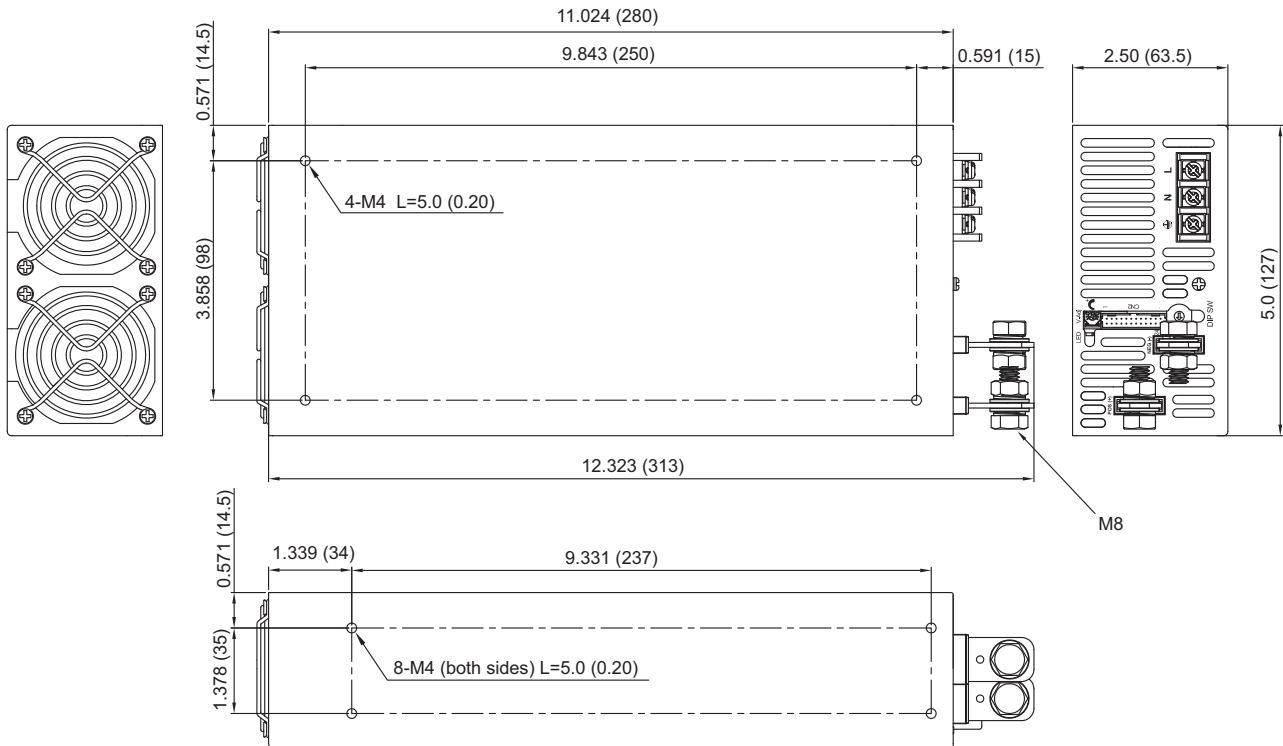

CN2 Control Pin Connections

Pin	Function	Description	Pin	Function	Description	Pin	Function	Description
1	NC.	Not Connected	9	VCI	V Program	17	PAR	Parallel Current Share
2	NC.	Not Connected	10	GND	Signal Ground	18	VSET	Auxiliary Output Set
3	AUX	Auxiliary Power	11	ACI	I Program	19	POK	Power OK
4	GND	Signal Ground	12	GND	Signal Ground	20	GND	Signal Ground
5	SCL	I ² C Serial Data	13	EN+	Inhibit ON/OFF (+)	21	VS-	Remote Sense (-)
6	SDA	I ² C Serial Data	14	AUX	Auxiliary Power	22	VO-	Output Voltage (-)
7	AUX	Auxiliary Power	15	EN-	Inhibit ON/OFF (-)	23	VS+	Remote Sense (+)
8	GND	Signal Ground	16	GND	Signal Ground	24	VO+	Output Voltage (+)

Notes

- All dimensions are in inches (mm).
- Weight 4.1 lb (1.9 kg)
- Maintain 2" (50mm) clear space at each end.
- Mating connector CN2: PHDR-24VS housing, PHD-002T-P05 contacts