

**INSULATED GATE BIPOLAR TRANSISTOR WITH ULTRA-LOW V<sub>F</sub> DIODE  
FOR INDUCTION HEATING AND SOFT SWITCHING APPLICATIONS**

### Features

- Low V<sub>CE(ON)</sub> trench IGBT Technology
- Low Switching Losses
- Square RBSOA
- Ultra-Low V<sub>F</sub> Diode
- 1300Vpk Repetitive Transient Capacity
- 100% of the Parts Tested for I<sub>LM</sub>①
- Positive V<sub>CE(ON)</sub> Temperature Co-Efficient
- Tight Parameter Distribution
- Lead Free Package

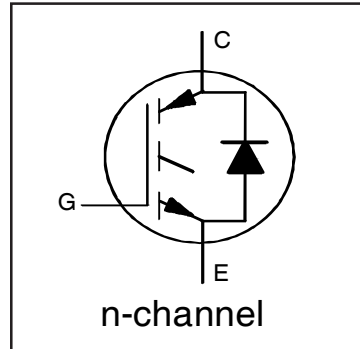

$$V_{CES} = 1200V$$

$$I_{NOMINAL} = 20A$$

$$T_{J(max)} = 150^{\circ}C$$

$$V_{CE(on)} \text{ typ.} = 1.9V$$

### Benefits

- Device optimized for induction heating and soft switching applications
- High Efficiency due to Low V<sub>CE(on)</sub>, low switching losses and Ultra-low V<sub>F</sub>
- Rugged transient performance for increased reliability
- Excellent current sharing in parallel operation
- Low EMI

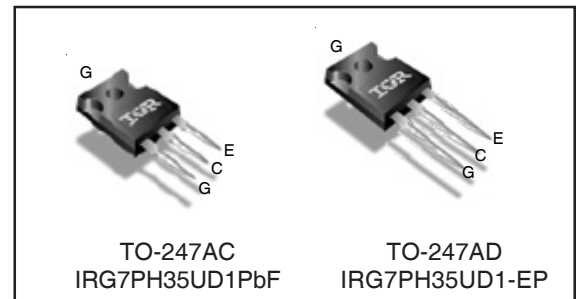

<b>G</b>	<b>C</b>	<b>E</b>
Gate	Collector	Emitter

Base part number	Package Type	Standard Pack		Orderable Part Number
		Form	Quantity	
IRG7PH35UD1PbF	TO-247AC	Tube	25	IRG7PH35UD1PbF
IRG7PH35UD1-EP	TO-247AD	Tube	25	IRG7PH35UD1-EP

### Absolute Maximum Ratings

	Parameter	Max.	Units
V <sub>CES</sub>	Collector-to-Emitter Voltage	1200	V
V <sub>(BR)</sub> Transient	Repetitive Transient Collector-to-Emitter Voltage ⑥	1300	
I <sub>C</sub> @ T <sub>C</sub> = 25°C	Continuous Collector Current	50	A
I <sub>C</sub> @ T <sub>C</sub> = 100°C	Continuous Collector Current	25	
I <sub>NOMINAL</sub>	Nominal Current	20	
I <sub>CM</sub>	Pulse Collector Current, V <sub>GE</sub> =15V ②⑤	150	
I <sub>LM</sub>	Clamped Inductive Load Current, V <sub>GE</sub> =20V ①	80	
I <sub>F</sub> @ T <sub>C</sub> = 25°C	Diode Continuous Forward Current	50	
I <sub>F</sub> @ T <sub>C</sub> = 100°C	Diode Continuous Forward Current	25	V
I <sub>FM</sub>	Diode Maximum Forward Current ②	80	
V <sub>GE</sub>	Continuous Gate-to-Emitter Voltage	±30	V
P <sub>D</sub> @ T <sub>C</sub> = 25°C	Maximum Power Dissipation	179	W
P <sub>D</sub> @ T <sub>C</sub> = 100°C	Maximum Power Dissipation	71	
T <sub>J</sub>	Operating Junction and	-55 to +150	°C
T <sub>STG</sub>	Storage Temperature Range		
	Soldering Temperature, for 10 sec.	300 (0.063 in. (1.6mm) from case)	
	Mounting Torque, 6-32 or M3 Screw	10 lbf-in (1.1 N·m)	

### Thermal Resistance

	Parameter	Min.	Typ.	Max.	Units
R <sub>θJC</sub> (IGBT)	Thermal Resistance Junction-to-Case-(each IGBT) ④	—	—	0.70	°C/W
R <sub>θJC</sub> (Diode)	Thermal Resistance Junction-to-Case-(each Diode) ④	—	—	1.35	
R <sub>θCS</sub>	Thermal Resistance, Case-to-Sink (flat, greased surface)	—	0.24	—	
R <sub>θJA</sub>	Thermal Resistance, Junction-to-Ambient (typical socket mount)	—	40	—	

**Electrical Characteristics @ T<sub>J</sub> = 25°C (unless otherwise specified)**

	Parameter	Min.	Typ.	Max.	Units	Conditions
V <sub>(BR)CES</sub>	Collector-to-Emitter Breakdown Voltage	1200	—	—	V	V <sub>GE</sub> = 0V, I <sub>C</sub> = 100μA ③
ΔV <sub>(BR)CES</sub> /ΔT <sub>J</sub>	Temperature Coeff. of Breakdown Voltage	—	1.2	—	V/°C	V <sub>GE</sub> = 0V, I <sub>C</sub> = 1mA (25°C-150°C)
V <sub>CE(on)</sub>	Collector-to-Emitter Saturation Voltage	—	1.9	2.2	V	I <sub>C</sub> = 20A, V <sub>GE</sub> = 15V, T <sub>J</sub> = 25°C
		—	2.3	—		I <sub>C</sub> = 20A, V <sub>GE</sub> = 15V, T <sub>J</sub> = 150°C
V <sub>GE(th)</sub>	Gate Threshold Voltage	3.0	—	6.0	V	V <sub>CE</sub> = V <sub>GE</sub> , I <sub>C</sub> = 600μA
g <sub>fe</sub>	Forward Transconductance	—	22	—	S	V <sub>CE</sub> = 50V, I <sub>C</sub> = 20A, PW = 30μs
I <sub>CES</sub>	Collector-to-Emitter Leakage Current	—	1.0	100	μA	V <sub>GE</sub> = 0V, V <sub>CE</sub> = 1200V
		—	120	—		V <sub>GE</sub> = 0V, V <sub>CE</sub> = 1200V, T <sub>J</sub> = 150°C
V <sub>FM</sub>	Diode Forward Voltage Drop	—	1.15	1.26	V	I <sub>F</sub> = 20A
		—	1.08	—		I <sub>F</sub> = 20A, T <sub>J</sub> = 150°C
I <sub>GES</sub>	Gate-to-Emitter Leakage Current	—	—	±100	nA	V <sub>GE</sub> = ±30V

**Switching Characteristics @ T<sub>J</sub> = 25°C (unless otherwise specified)**

	Parameter	Min.	Typ.	Max.	Units	Conditions
Q <sub>g</sub>	Total Gate Charge (turn-on)	—	85	130	nC	I <sub>C</sub> = 20A
Q <sub>ge</sub>	Gate-to-Emitter Charge (turn-on)	—	15	20		V <sub>GE</sub> = 15V
Q <sub>gc</sub>	Gate-to-Collector Charge (turn-on)	—	35	50		V <sub>CC</sub> = 600V
E <sub>off</sub>	Turn-Off Switching Loss	—	620	850	μJ	I <sub>C</sub> = 20A, V <sub>CC</sub> = 600V, V <sub>GE</sub> = 15V R <sub>G</sub> = 10Ω, L = 200μH, L <sub>S</sub> = 150nH, T <sub>J</sub> = 25°C Energy losses include tail
t <sub>d(off)</sub>	Turn-Off delay time	—	160	180	ns	I <sub>C</sub> = 20A, V <sub>CC</sub> = 600V, V <sub>GE</sub> = 15V
t <sub>f</sub>	Fall time	—	80	105		R <sub>G</sub> = 10Ω, L = 200μH, L <sub>S</sub> = 150nH, T <sub>J</sub> = 25°C
E <sub>off</sub>	Turn-Off Switching Loss	—	1120	—	μJ	I <sub>C</sub> = 20A, V <sub>CC</sub> = 600V, V <sub>GE</sub> = 15V R <sub>G</sub> = 10Ω, L = 200μH, L <sub>S</sub> = 150nH, T <sub>J</sub> = 150°C Energy losses include tail
t <sub>d(off)</sub>	Turn-Off delay time	—	190	—	ns	I <sub>C</sub> = 20A, V <sub>CC</sub> = 600V, V <sub>GE</sub> = 15V
t <sub>f</sub>	Fall time	—	210	—		R <sub>G</sub> = 10Ω, L = 200μH, L <sub>S</sub> = 150nH, T <sub>J</sub> = 150°C
C <sub>ies</sub>	Input Capacitance	—	1940	—	pF	V <sub>GE</sub> = 0V
C <sub>oes</sub>	Output Capacitance	—	120	—		V <sub>CC</sub> = 30V
C <sub>res</sub>	Reverse Transfer Capacitance	—	40	—		f = 1.0Mhz
RBSOA	Reverse Bias Safe Operating Area	FULL SQUARE				T <sub>J</sub> = 150°C, I <sub>C</sub> = 80A V <sub>CC</sub> = 960V, V <sub>p</sub> = 1200V R <sub>g</sub> = 10Ω, V <sub>GE</sub> = +20V to 0V

**Notes:**

- ① V<sub>CC</sub> = 80% (V<sub>CES</sub>), V<sub>GE</sub> = 20V, R<sub>G</sub> = 10Ω.
- ② Pulse width limited by max. junction temperature.
- ③ Refer to AN-1086 for guidelines for measuring V<sub>(BR)CES</sub> safely.
- ④ R<sub>θ</sub> is measured at T<sub>J</sub> approximately 90°C.
- ⑤ FBSOA operating conditions only.
- ⑥ V<sub>GE</sub> = 0V, T<sub>J</sub> = 75°C, PW ≤ 10μs.

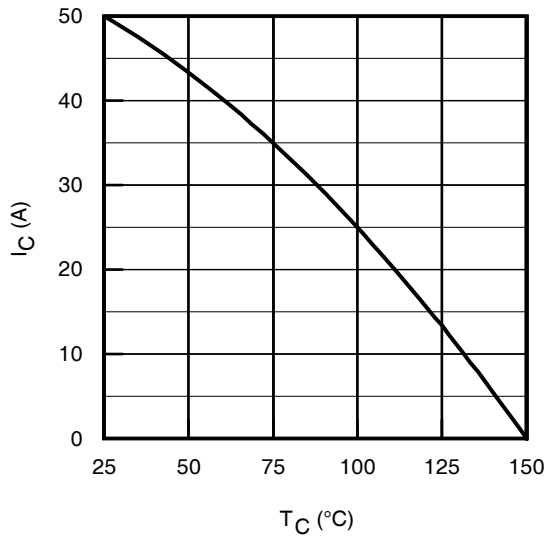

**Fig. 1** - Maximum DC Collector Current vs. Case Temperature

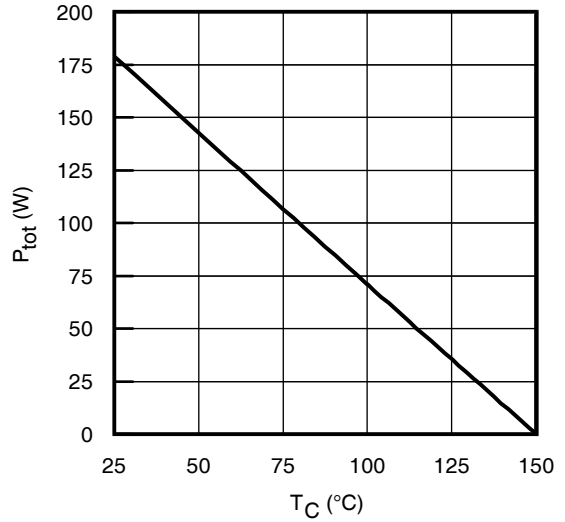

**Fig. 2** - Power Dissipation vs. Case Temperature

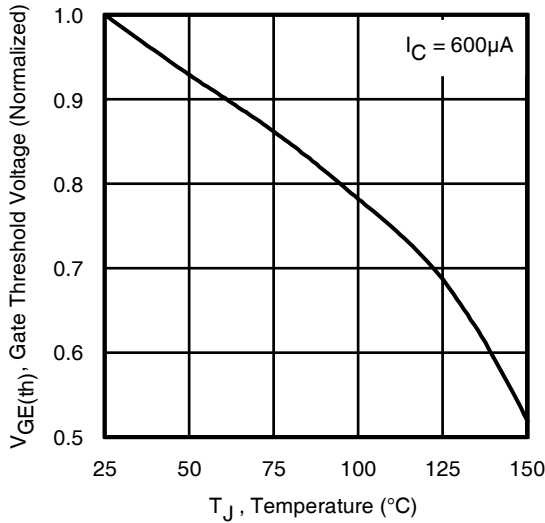

**Fig. 3** - Typical Gate Threshold Voltage (Normalized) vs. Junction Temperature

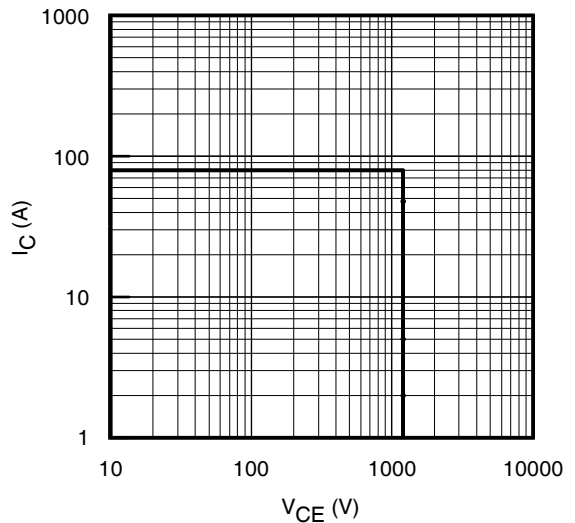

**Fig. 4** - Reverse Bias SOA  
 $T_J = 150^\circ\text{C}$ ;  $V_{GE} = 20\text{V}$

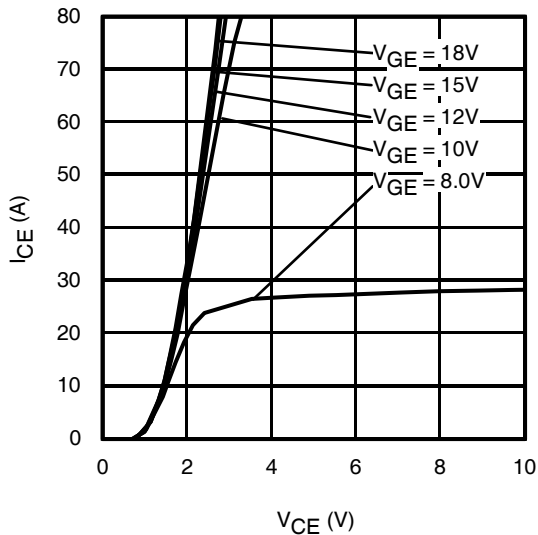

**Fig. 5** - Typ. IGBT Output Characteristics  
 $T_J = -40^\circ\text{C}$ ;  $t_p = 30\mu\text{s}$

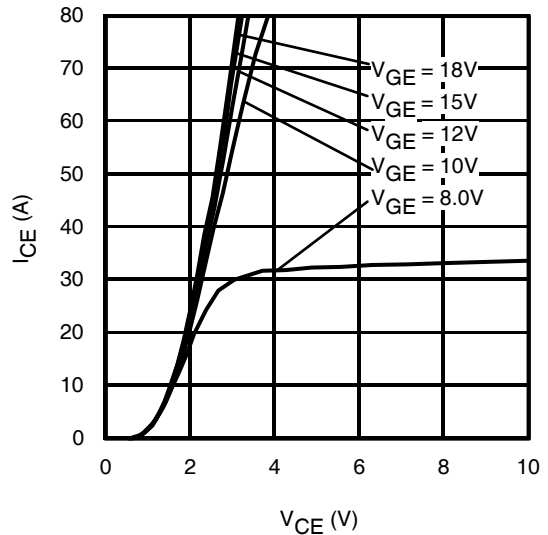

**Fig. 6** - Typ. IGBT Output Characteristics  
 $T_J = 25^\circ\text{C}$ ;  $t_p = 30\mu\text{s}$

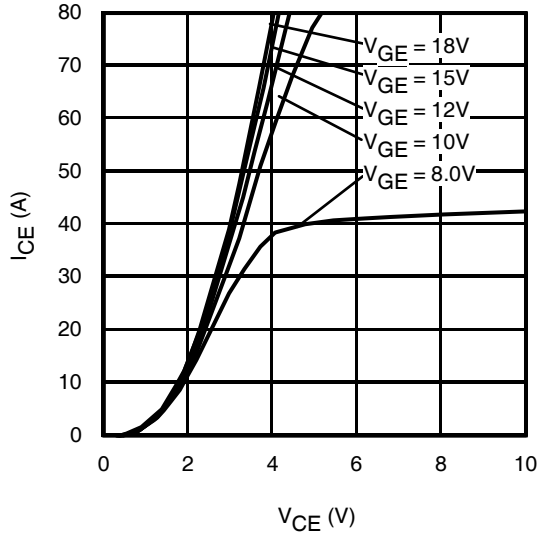

**Fig. 7 - Typ. IGBT Output Characteristics**  
 $T_J = 150^\circ\text{C}$ ;  $t_p = 30\mu\text{s}$

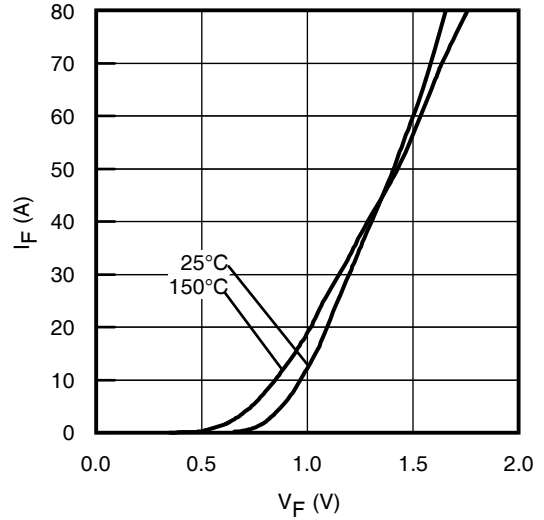

**Fig. 8 - Typ. Diode Forward Voltage Drop Characteristics**

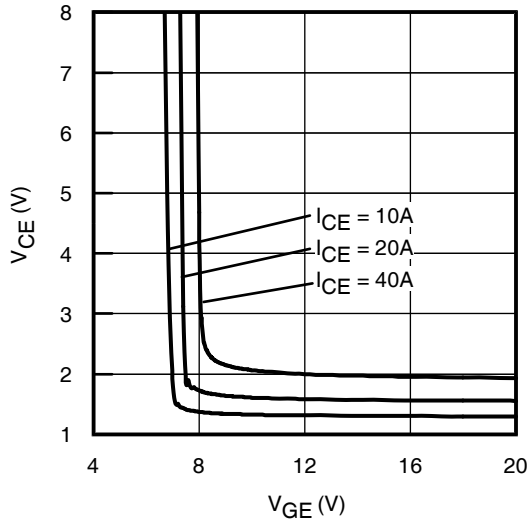

**Fig. 9 - Typical  $V_{CE}$  vs.  $V_{GE}$**   
 $T_J = -40^\circ\text{C}$

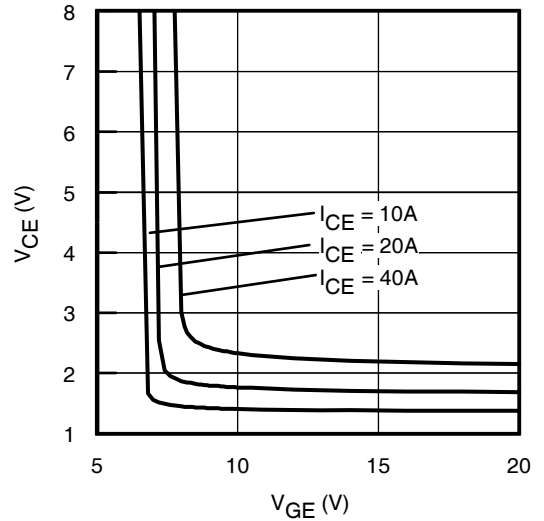

**Fig. 10 - Typical  $V_{CE}$  vs.  $V_{GE}$**   
 $T_J = 25^\circ\text{C}$

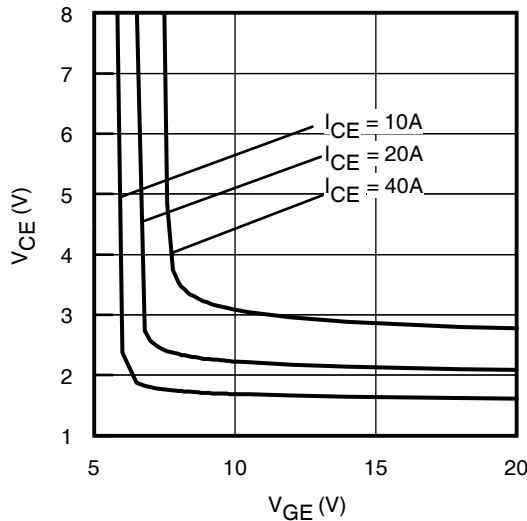

**Fig. 11 - Typical  $V_{CE}$  vs.  $V_{GE}$**   
 $T_J = 150^\circ\text{C}$

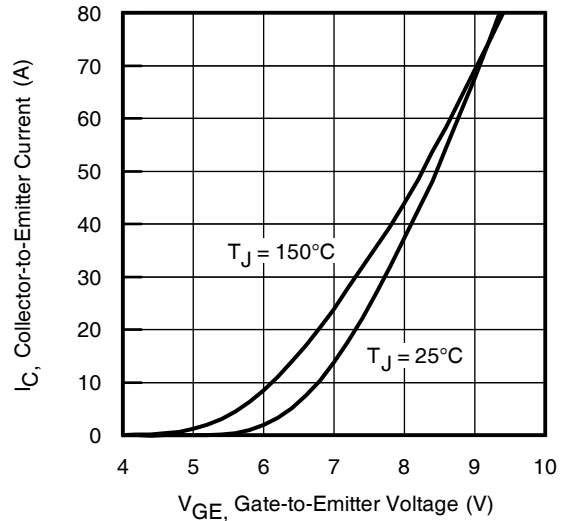

**Fig. 12 - Typ. Transfer Characteristics**  
 $V_{CE} = 50\text{V}$ ;  $t_p = 30\mu\text{s}$

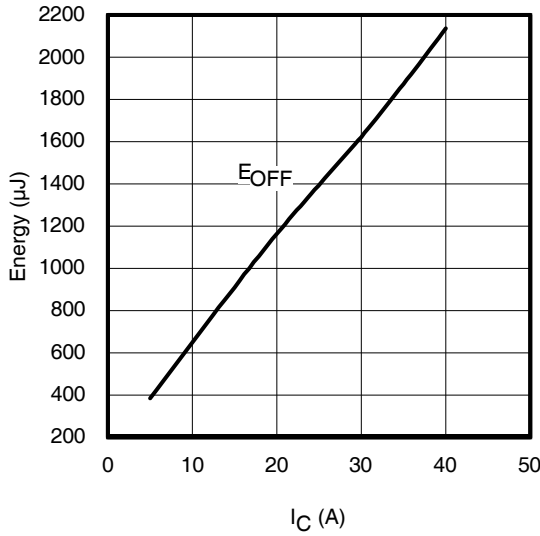

Fig. 13 - Typ. Energy Loss vs.  $I_C$

$T_J = 150^\circ\text{C}$ ;  $L = 680\mu\text{H}$ ;  $V_{CE} = 600\text{V}$ ,  $R_G = 10\Omega$ ;  $V_{GE} = 15\text{V}$

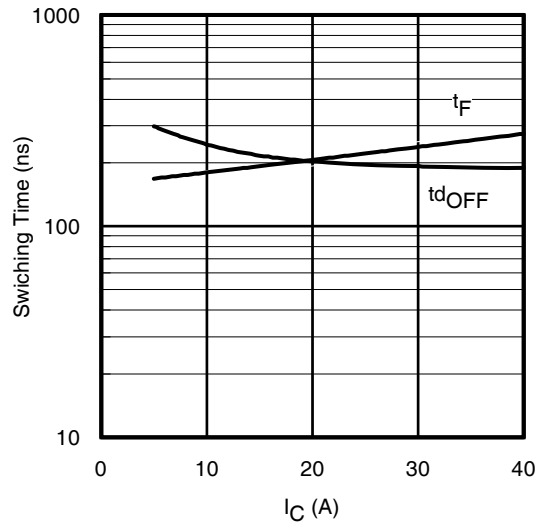

Fig. 14 - Typ. Switching Time vs.  $I_C$

$T_J = 150^\circ\text{C}$ ;  $L = 680\mu\text{H}$ ;  $V_{CE} = 600\text{V}$ ,  $R_G = 10\Omega$ ;  $V_{GE} = 15\text{V}$

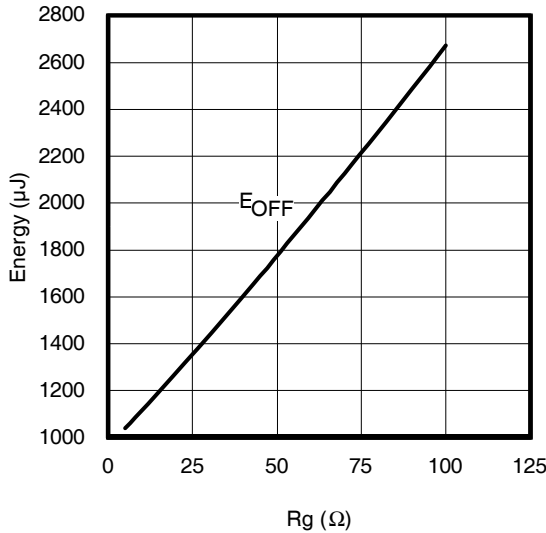

Fig. 15 - Typ. Energy Loss vs.  $R_G$

$T_J = 150^\circ\text{C}$ ;  $L = 680\mu\text{H}$ ;  $V_{CE} = 600\text{V}$ ,  $I_{CE} = 20\text{A}$ ;  $V_{GE} = 15\text{V}$

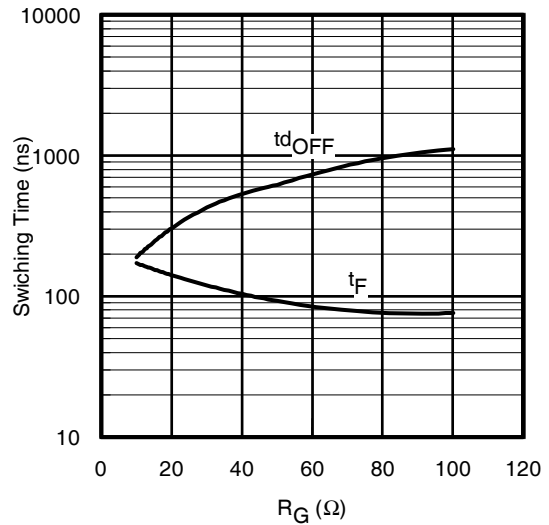

Fig. 16 - Typ. Switching Time vs.  $R_G$

$T_J = 150^\circ\text{C}$ ;  $L = 680\mu\text{H}$ ;  $V_{CE} = 600\text{V}$ ,  $I_{CE} = 20\text{A}$ ;  $V_{GE} = 15\text{V}$

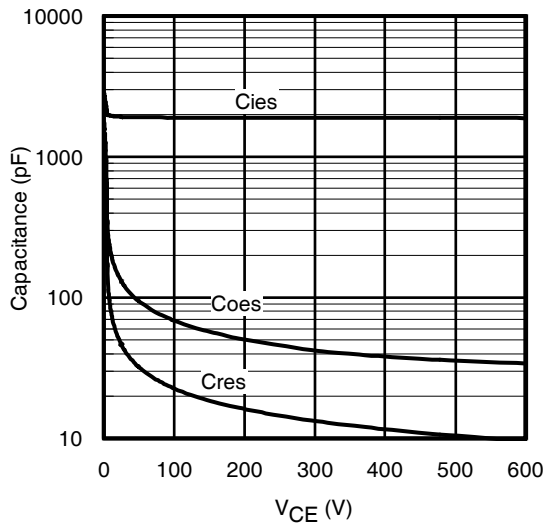

Fig. 17 - Typ. Capacitance vs.  $V_{CE}$   
 $V_{GE} = 0\text{V}$ ;  $f = 1\text{MHz}$

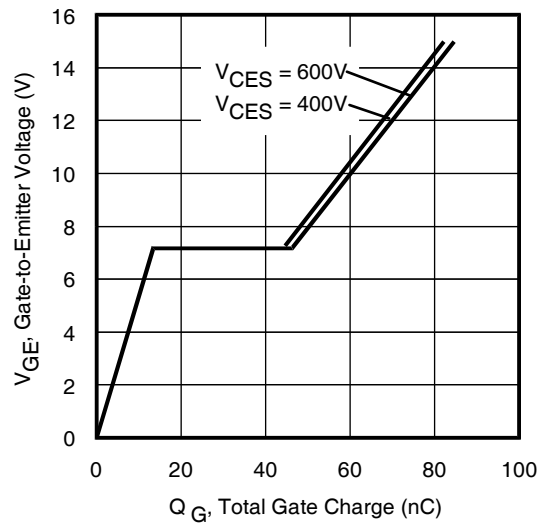

Fig. 18 - Typical Gate Charge vs.  $V_{GE}$   
 $I_{CE} = 20\text{A}$ ;  $L = 2.4\text{mH}$

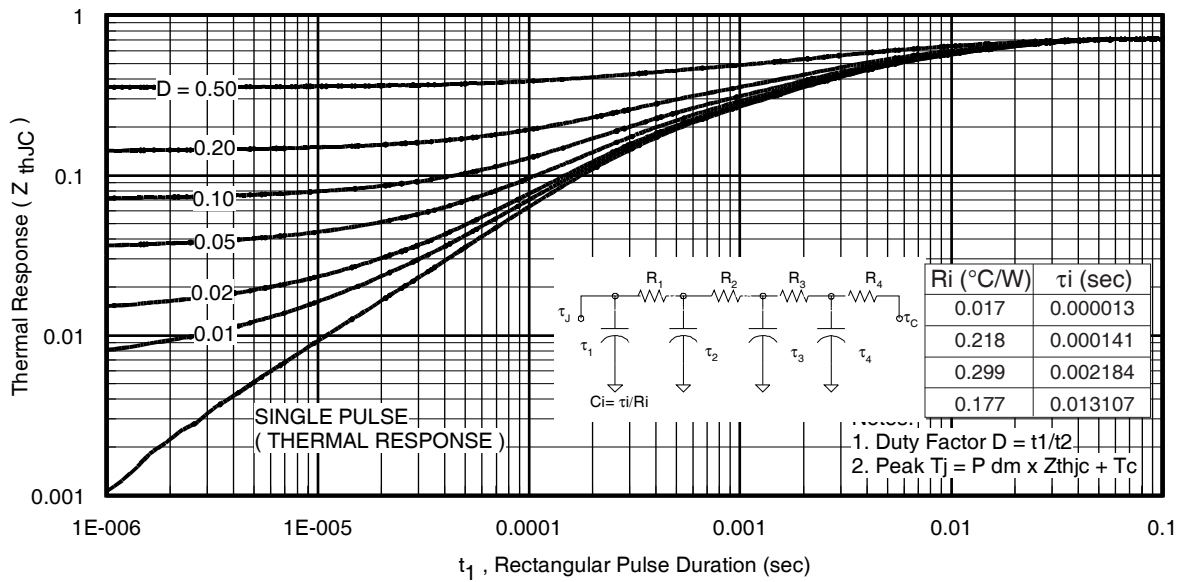

Fig 19. Maximum Transient Thermal Impedance, Junction-to-Case (IGBT)

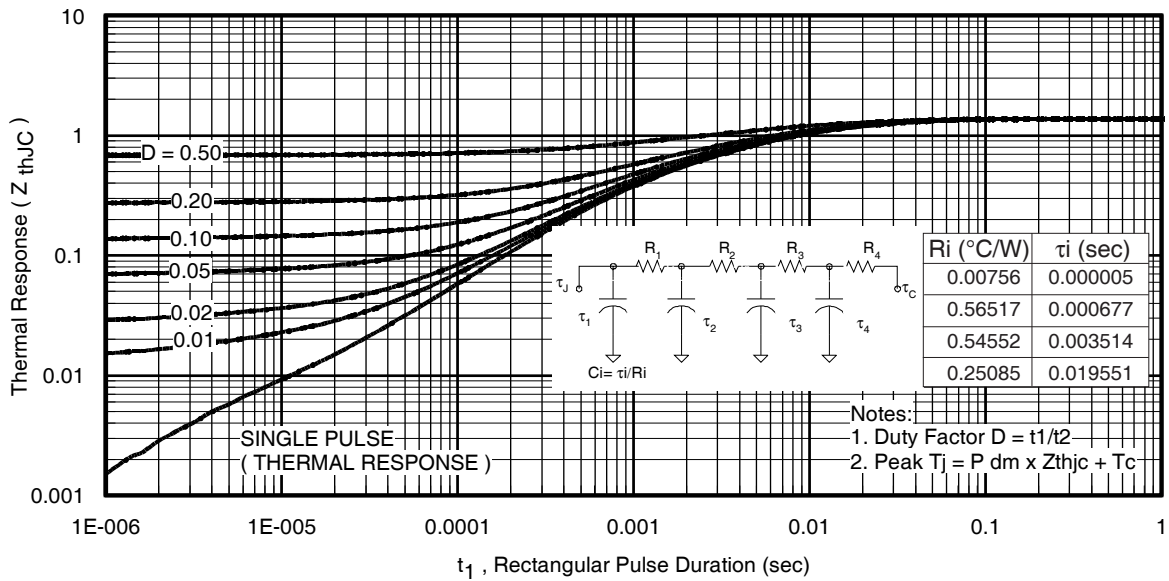

Fig. 20. Maximum Transient Thermal Impedance, Junction-to-Case (DIODE)

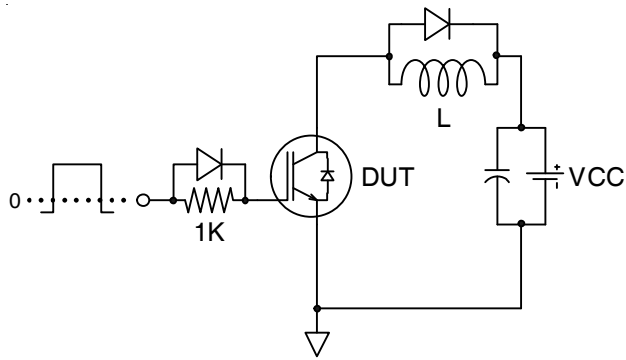

Fig.C.T.1 - Gate Charge Circuit (turn-off)

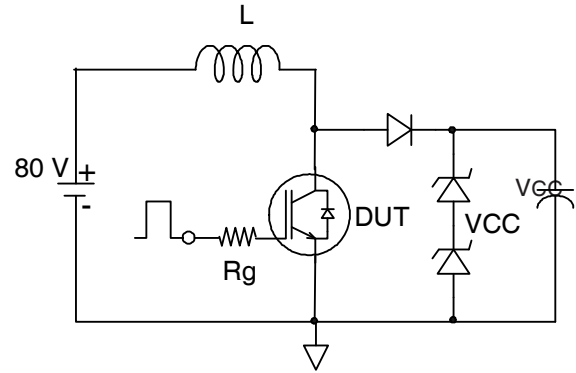

Fig.C.T.2 - RBSOA Circuit

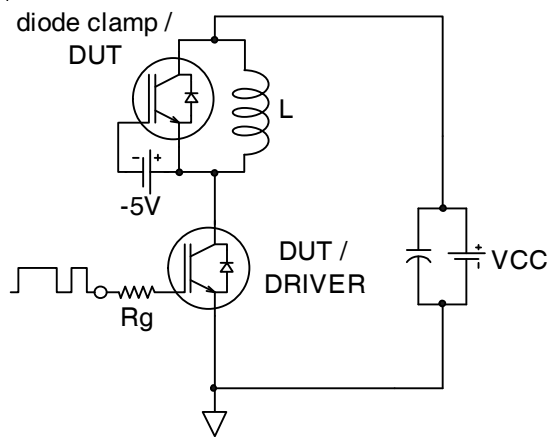

Fig.C.T.3 - Switching Loss Circuit

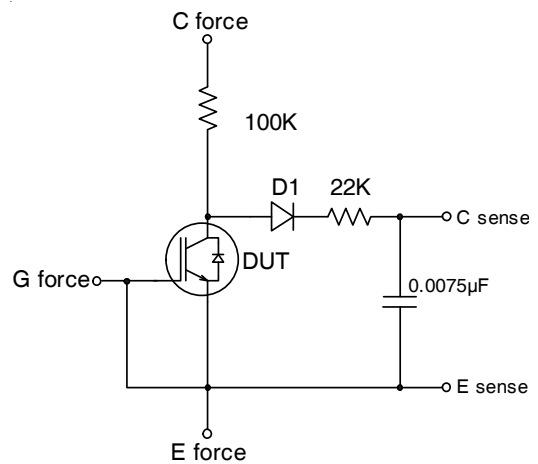

Fig.C.T.4 - BVCES Filter Circuit

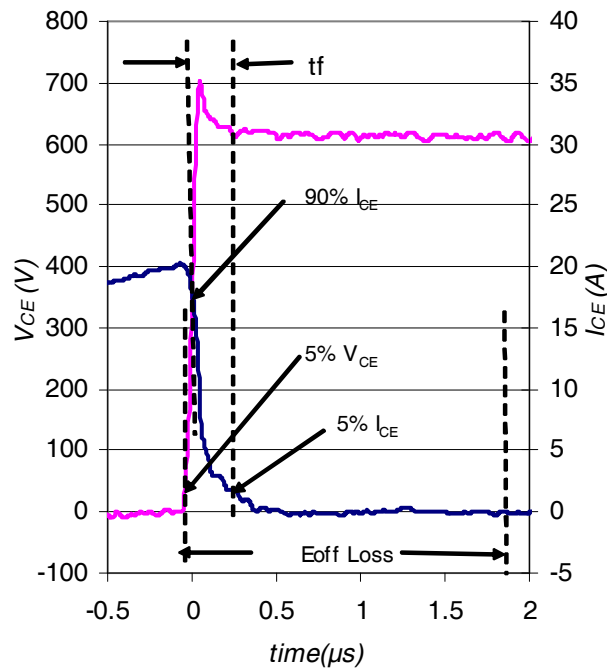

Fig. WF1 - Typ. Turn-off Loss Waveform  
@  $T_J = 150^\circ\text{C}$  using Fig. CT.3





### TO-247AD Package Outline

Dimensions are shown in millimeters (inches)

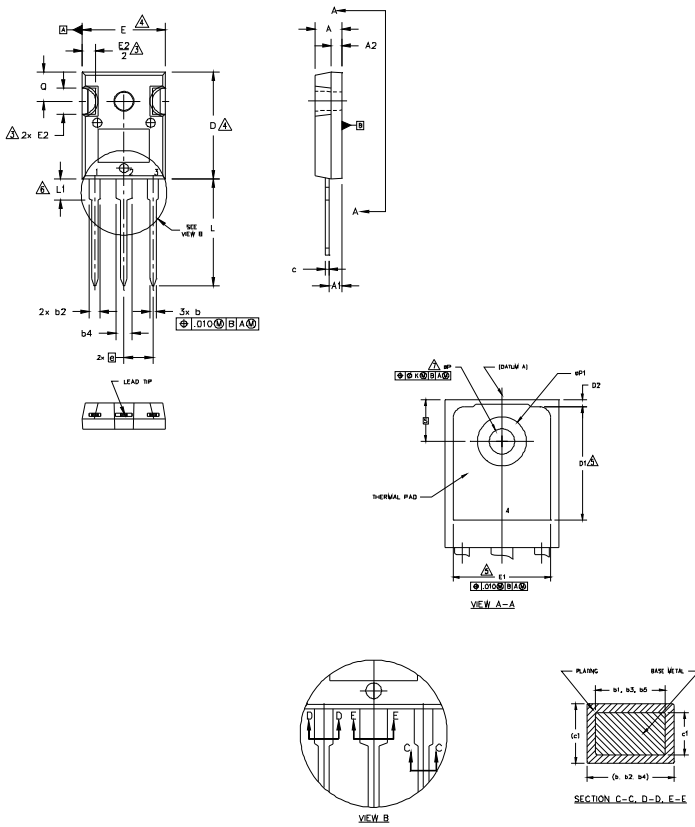

**NOTES:**

1. DIMENSIONING AND TOLERANCING AS PER ASME Y14.5M 1994.
2. DIMENSIONS ARE SHOWN IN INCHES.
3. CONTOUR OF SLOT OPTIONAL.
4. DIMENSION D & E DO NOT INCLUDE MOLD FLASH. MOLD FLASH SHALL NOT EXCEED .005" (0.127) PER SIDE. THESE DIMENSIONS ARE MEASURED AT THE OUTERMOST EXTREMES OF THE PLASTIC BODY.
5. THERMAL PAD CONTOUR OPTIONAL WITHIN DIMENSIONS D1 & E1.
6. LEAD FINISH UNCONTROLLED IN L1.
7. øP TO HAVE A MAXIMUM DRAFT ANGLE OF 1.5° TO THE TOP OF THE PART WITH A MAXIMUM HOLE DIAMETER OF .154 INCH.
8. OUTLINE CONFORMS TO JEDEC OUTLINE TO-247AD.

SYMBOL	DIMENSIONS				NOTES
	INCHES		MILLIMETERS		
	MIN.	MAX.	MIN.	MAX.	
A	.183	.209	4.65	5.31	
A1	.087	.102	2.21	2.59	
A2	.059	.098	1.50	2.49	
b	.039	.055	0.99	1.40	
b1	.039	.053	0.99	1.35	
b2	.065	.094	1.65	2.39	
b3	.065	.092	1.65	2.34	
b4	.102	.135	2.59	3.43	
b5	.102	.133	2.59	3.38	
c	.015	.035	0.38	0.89	
c1	.015	.033	0.38	0.84	
D	.776	.815	19.71	20.70	4
D1	.515	-	13.08	-	5
D2	.020	.053	0.51	1.35	
E	.602	.625	15.29	15.87	4
E1	.530	-	13.46	-	
E2	.178	.216	4.52	5.49	
e	.215 BSC		5.46 BSC		
øk	.010		0.25		
L	.780	.827	19.57	21.00	
L1	.146	.169	3.71	4.29	
øP	.140	.144	3.56	3.66	
øP1	-	.291	-	7.39	
O	.209	.224	5.31	5.69	
S	.217 BSC		5.51 BSC		

**LEAD ASSIGNMENTS**

**HEXFET**

- 1.- GATE
- 2.- DRAIN
- 3.- SOURCE
- 4.- DRAIN

**IGBTs, CoPACK**

- 1.- GATE
- 2.- COLLECTOR
- 3.- EMITTER
- 4.- COLLECTOR

**DIODES**

- 1.- ANODE/OPEN
- 2.- CATHODE
- 3.- ANODE

### TO-247AD Part Marking Information

EXAMPLE: THIS IS AN IRGP30B120KD-E  
WITH ASSEMBLY  
LOT CODE 5657  
ASSEMBLED ON WW 35, 2000  
IN THE ASSEMBLY LINE "H"

Note: "P" in assembly line position  
indicates "Lead-Free"

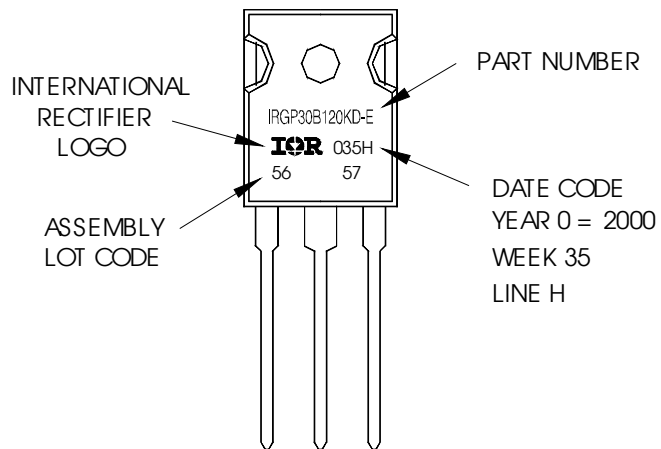

TO-247AD package is not recommended for Surface Mount Application.

Note: For the most current drawing please refer to IR website at <http://www.irf.com/package/>

**Qualification Information<sup>†</sup>**

<b>Qualification Level</b>	Industrial <sup>†</sup> (per JEDEC JESD47F) <sup>††</sup>	
<b>Moisture Sensitivity Level</b>	TO-247AC	N/A
	TO-247AD	N/A
<b>RoHS Compliant</b>	Yes	

† Qualification standards can be found at International Rectifier’s web site: <http://www.irf.com/product-info/reliability/>

†† Applicable version of JEDEC standard at the time of product release.

**Revision History**

<b>Date</b>	<b>Comments</b>
4/19/2013	Document updated to new IR corporate template